



Historic Context Interstate-70 Mountain Corridor

June 2014

Prepared For:



COLORADO
Department of Transportation

Produced By:

Mountain States Historical
and



CH2MHILL



Historic Context

Interstate-70 Mountain Corridor

June 2014

Prepared For:

Colorado Department of Transportation
4201 East Arkansas
Denver, CO, 80222

Written By:

Eric Twitty, Mountain States Historical

Contributions From:

Caitlin McCusker, CH2M HILL (Roads and Tourism)
Carl McWilliams (Architecture)
Michelle Slaughter, Avalon Archaeological Consultants (Tourism research)

Produced By:

Mountain States Historical
1011 Glenwood Dr.
Lafayette, CO, 80026
(303)499-4334
and
CH2M HILL
9193 South Jamaica St.
Englewood, CO, 80112

Table of Contents

Section A:

Statement of Historic Contexts.....	1
Context Description	2
List of Common Acronyms	4
A 1.1 History of Mining in the I-70 Mountain Corridor, 1859-1942.....	5
Introduction.....	5
Period of Significance, 1859-1942	5
A 1.2 History of Mining in Clear Creek Drainage, 1859-1942.....	6
Introduction.....	6
Discovery and the Placer Boom, 1859-1864	8
Silver Boom in the Western Drainage, 1865-1874.....	16
Silver Mining in the Western Drainage, 1875-1893.....	27
Gold Mining in the Eastern Drainage, 1875-1893.....	38
The Silver Crash, 1894-1897	48
Peak Production in the Eastern Drainage, 1898-1918	51
Gradual Decline in the Western Drainage, 1898-1907.....	61
World War I Revival in the Western Drainage, 1915-1920	68
Great Depression Revival in the Eastern Drainage, 1930-1942	69
A 1.3 History of Mining at Frisco and Dillon, Summit County.....	76
Introduction.....	76
Exploration and Early Development, 1859-1877	76
Settlement and the Establishment of Industry, 1878-1885	78
Mining Revival, 1890-1893.....	80
The Great Mining Revival, 1898-1912.....	81
World War I Revival, 1916-1920	85
A 1.4 Mining and Milling Methods, Technology, and Equipment.....	87
Placer Mining.....	87
The Nature of Placer Deposits	87
Prospecting for Placer Gold.....	88
Placer Mining Methods.....	88
Hardrock Mining.....	90
The Nature of Hardrock Ore Deposits	90
Prospecting for Hardrock Ore.....	90
Deep Exploration and the Development of Ore Bodies.....	91
The Mine Surface Plant	93
Surface Plants for Tunnels	94
Surface Plants for Shafts.....	98

Additional Surface Plant Components.....	111
Ore Beneficiation: Smelting, Ore Concentration, and Amalgamation	121
Smelters.....	122
Concentration Mills	123
Amalgamation Stamp Mills	125
Arrastras	126
A 2 History of the Timber Industry, 1860-1920	128
Introduction.....	128
Period of Significance, 1860-1920	128
Overview of Forest Products	129
Land Use Policy and the Timber Industry	131
The Timber Industry in Clear Creek Drainage	134
The Timber Industry in Clear Creek Drainage, 1860-1876.....	134
The Timber Industry in Clear Creek Drainage, 1877-1920.....	136
The Timber Industry in Dillon and Frisco Area	139
The Timber Industry in Dillon and Frisco Area, 1879-1886.....	140
The Timber Industry in Dillon and Frisco Area, 1890-1893.....	141
The Timber Industry in Dillon and Frisco Area, 1898-1912.....	141
The Timber Industry in Eagle River Valley, 1886-1920	142
A 3 History of High Altitude Agriculture, 1860-1960.....	145
Period of Significance, 1860-1960	145
Homesteading	145
Ranching	145
Farming.....	146
History of Homesteading, Ranching, and Farming	146
Early Agricultural Settlement in the Mountains, 1860-1892.....	146
Mountain Agriculture Perseveres, 1893-1919	153
Ranching and Farming Struggles, 1920-1940	155
Ranching and Farming Declines in Importance, 1941-1960	156
A 4 History of Electric Power Generation, 1883-1962.....	158
Introduction.....	158
Period of Significance, 1883-1962	158
Electric Power in Clear Creek Drainage, 1883-1962.....	159
Beginning of Clear Creek Electric Grid, 1883-1905	162
Consolidation and Contraction, 1906-1920	166
Public Service Company and Last Major Changes, 1921-1964	168
Electric Power in Summit County, 1898-1936.....	169
Beginning of Ten Mile and Dillon Electric Grid, 1898-1906.....	171
Centralized Electric Service, 1907-1920	172
Public Service Company and Last Major Changes, 1921-1936	173
Shoshone Plant and Colorado River Valley, 1906-1962	174
Central Colorado Power’s Shoshone Plant, 1906-1909.....	174

The Shoshone Plant Changes Ownership, 1910-1924.....	178
Public Service and its Unified Grid, 1925-1962.....	179
A 5 History of Railroad Transportation, 1873-1962.....	180
Introduction.....	180
Period of Significance, 1873-1962	180
Overview of Railroad Systems	181
Clear Creek Drainage Railroad System, 1873-1940.....	182
Colorado Central Railroad: Organized, 1865-1870.....	184
Colorado Central Railroad: Expansion, 1871-1876.....	185
Colorado Central Railroad: Georgetown Extension, 1877-1880.....	188
Georgetown, Breckenridge & Leadville Railroad: Built, 1881-1884.....	190
Clear Creek Railroad System: Peak Years, 1885-1904	193
Argentine Central Railroad: Added to System, 1905-1911	195
Clear Creek Railroad System: Gradual Decline, 1912-1920.....	197
Clear Creek Railroad System: Major Decline, 1921-1929	198
End of Clear Creek Railroad System, 1930-1940.....	199
Ten Mile Canyon and Blue River Drainage Railroad System, 1882-1937.....	200
Denver & Rio Grande Railroad: Organized, 1870-1876	202
D&RG: the Push to Leadville, 1877-1880.....	203
D&RG: Builds the Dillon Branch, 1881	205
D&RG: Operates the Dillon Branch, 1883-1911.....	206
Denver, South Park & Pacific Railroad: Organized, 1872-1877	207
DSP&P: Builds to Leadville, 1877-1880.....	207
DSP&P: Builds the High Line, 1881-1884.....	209
DSP&P: Operates the High Line, 1885-1893.....	210
Denver, Leadville & Gunnison Railroad: Operates the High Line, 1894-1897 ..	210
Colorado & Southern Railroad: Operates the High Line, 1898-1920	211
End of the DSP&P High Line, 1921-1938.....	212
Eagle and Colorado River Valley Railroad System, 1886-1962	213
D&RG Builds Leadville to Glenwood Branch, 1881-1887.....	213
D&RG Builds the Grand Junction Extension, 1888-1890.....	215
D&RG Operations Stabilize, 1891-1899	216
D&RG Operated by George Gould, 1900-1915	217
D&RG Reorganized, 1916-1920	219
D&RG and Transcontinental Service, 1921-1929	220
D&RGW Builds the Dotsero Cutoff, 1930-1933	222
D&RGW Operates during the Great Depression, 1934-1941	222
D&RGW Booms during World War II, 1942-1946	224
D&RGW Absorbed, 1947-1988	224
A 6 History of Road Transportation, 1859-1962.....	227
Introduction.....	227
Period of Significance, 1859-1962	227
Overview of Pack Trails and Roads in the Corridor.....	228
History of Pack Trails and Roads, 1859-1962	229
Pack Trails and Wagon Roads, 1859-1892.....	229

Public Stewardship and the Good Roads Movement, 1893-1909	238
Early Automobile Roads, 1910-1932	239
From the New Deal to the Interstate Era, 1933-1962	242
A 7 History of Tourism and Recreation, 1860-1962	246
Introduction.....	246
Period of Significance, 1860-1962	247
History of Skiing.....	248
Evolution of Skiing as Recreation, 1860-1934	248
Development of Resort Skiing, 1935-1944	250
Growth of Ski Tourism, 1945-1962.....	251
History of Scenic Tourism and Resorts	255
Early Scenic Tourism and Recreation, 1860-1877	255
Railroads and Resorts, 1878-1914	256
Automobiles and Scenic Tourism, 1915-1962.....	259
History of Outdoor Recreation.....	261
Fishing and Hatcheries.....	264
Hunting	265
Hiking and Mountaineering	267
Camping.....	269
Section B:	
Introduction to Property Types and Registration Requirements.....	272
Definitions for Resources and Site Features	273
B 1 Mining Industry Property Types and Registration Requirements	275
Property Type: Placer Mine	276
Property Subtype: Gulch Placer.....	276
Property Subtype: Stream Placer	276
Property Subtype: River Bar Placer	276
Property Subtype: Hydraulic Placer.....	276
Placer Mine Significance	276
Placer Mine Registration Requirements	279
Property Type: Hardrock Prospect.....	280
Property Subtype: Prospect Complex	280
Property Subtype: Prospect Shaft	280
Property Subtype: Prospect Adit.....	280
Hard Rock Prospect Significance	280
Hard Rock Prospect Registration Requirements.....	282
Property Type: Hardrock Mine	283
Property Subtype: Shaft Mine.....	284
Property Subtype: Tunnel Mine.....	284
Hard Rock Mine Significance.....	284
Hard Rock Mine Registration Requirements	286
Property Type: Ore Treatment Mill	288

Property Subtype: Concentration Mill	289
Property Subtype: Amalgamation Stamp Mill.....	289
Property Subtype: Arrastra	289
Ore Treatment Mill Significance	289
Ore Treatment Mill Registration Requirements	292
Property Type: Smelter	294
Smelter Significance	294
Smelter Registration Requirements	296
Mining Settlement and Residence Property Types	298
Property Type: Prospector’s Camp.....	298
Prospector’s Camp Significance	298
Prospector’s Camp Registration Requirements	299
Property Type: Workers’ Housing.....	301
Workers’ Housing Significance	301
Workers’ Housing Registration Requirements	302
Property Type: Isolated Residence	304
Property Type: Mining Settlement.....	304
Property Subtype: Unincorporated Settlement	304
Property Subtype: Townsite.....	305
Mining Settlement Significance.....	306
Mining Registration Requirements	308
Property Type: Rural Historic Mining Landscape.....	310
Rural Historic Mining Landscape Significance	311
Rural Historic Mining Landscape Registration Requirements	313
Mining Industry Site Features.....	314
Placer Mine Feature Types	314
Hardrock Prospect Feature Types.....	315
Hardrock Mine Feature Types	318
Ore Treatment Mill Feature Types	325
Smelter Feature Types	329
Mining Settlement Feature Types.....	330
B 2 Timber Industry Property Types and Registration Requirements	336
Property Type: Sawmill Site.....	336
Sawmill Site Significance	338
Sawmill Site Registration Requirements	340
Property Type: Logging Camp	341
Property Subtype: Single Residence Logging Camp.....	341
Property Subtype: Multiple Residence Logging Camp	343
Logging Camp Significance	344
Logging Camp Registration Requirements.....	345
Property Type: Loading Station.....	347
Loading Station Significance	348
Loading Station Registration Requirements	348
Property Type: Tie Collection Point.....	349
Tie Collection Point Significance	350

Tie Collection Point Registration Requirements	350
Property Type: Flume	351
Flume Significance	353
Flume Registration Requirements.....	353
Property Type: Rural Historic Timber Industry Landscape	355
Rural Historic Timber Industry Significance.....	356
Rural Historic Timber Industry Registration Requirements	357
Timber Industry Site Features.....	359
Sawmill Feature Types	359
Logging Camp Feature Types.....	361
Transportation System Feature Types	362
Loading Station and Tie Collection Point Feature Types	363
Flume Feature Types.....	363
B 3 High Altitude Agriculture Property Types and Registration Requirements	365
Property Type: Homestead	365
Property Subtype: Homestead Residential Building.....	367
Property Subtype: Homestead Support Facilities	370
Property Subtype: Homestead Livestock and Crop Storage Facilities	370
Homestead Significance.....	371
Homestead Registration Requirements.....	372
Property Type: Ranch	374
Property Subtype: Ranch Residential Building	375
Property Subtype: Ranch Support Facilities	376
Property Subtype: Ranch Livestock and Crop Storage Facilities	377
Ranch Significance	378
Ranch Registration Requirements.....	380
Property Type: Farm	381
Property Subtype: Farm Residential Building	382
Property Subtype: Farm Support Facilities.....	384
Property Subtype: Farm Livestock and Crop Storage Facilities.....	384
Farm Significance	385
Farm Registration Requirements	353
Property Type: Rural Historic Agricultural Landscape	388
Rural Historic Agricultural Landscape Significance	390
Rural Historic Agricultural Landscape Registration Requirements	391
High Altitude Agriculture Site Features	393
Homestead, Ranch, and Farm Residence Types.....	393
Secondary Support Facility Feature Types	398
Livestock and Crop Storage Facility Feature Types.....	399
Rural Historic Agricultural Landscape Feature Types	400
B 4 Electric Power Property Types and Registration Requirements.....	402
Property Type: Power Plant Site.....	402
Property Type: Substation.....	404
Property Type: Powerline	405

Property Type: Infrastructure Components	406
Property Type: Reservoir	407
Electric Power Property Type Significance	407
Electric Power Property Type Registration Requirements	410
Electric Power Site Features	412
Power Plant Feature Types	412
Substation Feature Types	415
Infrastructure Feature Types	416
Reservoir Feature Types	417
B 5 Railroad Property Types and Registration Requirements.....	419
Property Type: Railroad Tracks and Roadbed.....	420
Property Type: Miscellaneous Right-of-Way Structures.....	420
Property Type: Depot.....	420
Property Subtype: Combination Depot.....	421
Property Subtype: Flag Depot.....	421
Property Subtype: Passenger Depot.....	421
Property Subtype: Temporary Depot	421
Property Type: Housing and Maintenance Facilities.....	421
Property Type: Drainage and Separation Structures.....	421
Property Subtype: Culvert.....	422
Property Subtype: Bridge.....	422
Property Subtype: Tunnel	422
Railroad Property Type Significance.....	422
Railroad Property Type Registration Requirements	424
Property Type: Rural Historic Railroad Landscape.....	427
Rural Historic Property Type Significance.....	427
Rural Historic Property Type Registration Requirements	429
Railroad Site Features	430
Railroad Grade Feature Types	430
Drainage Structure and Tunnel Feature Types	431
Right-of-Way Structure and Object Feature Types	431
Maintenance Facility Feature Types	433
B 6 Pack Trail and Road Property Types and Registration Requirements	438
Property Type: Pack Trail.....	439
Property Type: Wagon Road	439
Property Type: Engineered State Roads and Highways	440
Pack Trail and Road Property Type Significance.....	440
Pack Trail and Road Property Type Registration Requirements	442
Road Features.....	444
Road Right-of-Way Feature Types	444
Drainage Structure and Tunnel Feature Types	445
Right-of-Way Structure and Object Feature Types	445

B 7 Tourism and Recreation Property Types and Registration Requirements	447
Property Type: Ski Area	447
Ski Area Significance	448
Ski Area Registration Requirements.....	451
Property Type: Resort.....	452
Resort Significance	453
Resort Registration Requirements	454
Property Type: Outdoor Recreation Site.....	455
Property Subtype: Fishing Camp.....	456
Property Subtype: Hunting Camp.....	457
Property Subtype: Campground.....	457
Property Subtype: Picnic Ground	458
Property Subtype: Trailhead/Trail	458
Outdoor Recreation Site Significance.....	459
Outdoor Recreation Registration Requirements	460
Tourism and Recreation Site Features	462
Ski Area Feature Types.....	462
Resort Feature Types	464
Outdoor Recreation Site Feature Types	466
B 8 Universal Architectural Property Types and Registration Requirements	469
Property Type: Domestic Residential Buildings.....	470
Property Subtype: Single Family Dwelling	470
Property Subtype: Multiple Family Dwelling.....	475
Property Subtype: Outbuilding	475
Domestic Building Significance	476
Domestic Building Registration Requirements	477
Property Type: Commercial Buildings	479
Property Subtype: False-Front Commercial Building	479
Property Subtype: Nineteenth Century Commercial Building	480
Property Subtype: Early Twentieth Century Commercial Building	480
Property Subtype: Automobile-Related Commercial Building	481
Commercial Building Significance.....	484
Commercial Building Registration Requirements	485
Property Type: Cultural, Religious, and Public Buildings	487
Property Subtype: Cultural/Social Building	487
Property Subtype: Government/Administrative Building	488
Property Subtype: Church.....	489
Cultural Building Significance	490
Cultural Building Registration Requirements.....	490
Section C:	
Geographic Area of I-70 Mountain Corridor	493

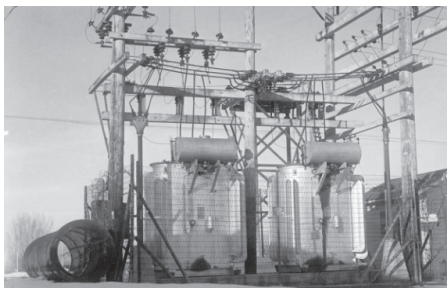
Section D:
Research Methodology495

Section E:
Major Bibliographic Sources.....500

Section F:
Illustrations518

Section A Illustrations 518-638

Section B Illustrations..... 639-680



SECTION A: STATEMENT OF HISTORIC CONTEXTS

Interstate 70 is an important route in the nation's highway system. The interstate is the only high-speed, multi-lane road crossing the central Rocky Mountains, linking Denver with numerous Colorado mountain communities and ultimately Interstate-15 in Utah. For much of its length, I-70 is largely as-built with two east-bound and two west-bound lanes separated by a median. A segment known as the Mountain Corridor, from Colorado Highway 470 at the east base of the mountains to Glenwood Springs in Garfield County, is among the most heavily traveled portions, carrying a high volume of both interstate and Colorado-based traffic (see Illustrations A 1 – A 5) in Section F of the document

To relieve growing congestion, Colorado Department of Transportation (CDOT) and the Federal Highway Administration (FHWA) jointly began planning additional lanes for I-70. But the corridor's environment, natural and manmade, greatly complicates the project. The corridor traverses one of Colorado's most scenic if not physically challenging regions, and one of historical importance. In consideration of this, CDOT and FHWA implemented the Context Sensitive Solutions (CSS) planning process, carefully coordinating design and construction with environmental factors. CDOT and FHWA developed a Programmatic Agreement with corridor stakeholder groups, identifying and addressing concerns, including numerous historic resources. CDOT hired engineering firm CH2M HILL to begin the CSS process and develop guidelines.

Potential impacts to the corridor's historic character were of primary concern in the CSS process, and preemptively addressed in Section IV of the Programmatic Agreement. The section required a historic context to guide implementation of Section 106 of the National Historic Preservation Act, when construction begins. The context had to structure identification and documentation of historic resources, and evaluation of their significance according to the National Register of Historic Places. Corridor stakeholder groups also required the context to serve their needs.

CH2M HILL contracted with historian and archaeologist Eric Twitty of Mountain States Historical, Lafayette, Colorado, to produce the context. In consultation with CDOT and corridor stakeholders, Mr. Twitty determined that most of the historic resources expected in the corridor could be categorized under seven broad historic themes: mining industry, timber industry, agriculture, electric power, railroad transportation, road transportation, and tourism and recreation. Mr. Twitty completed research and text for most of the themes, consulting with other cultural resource experts for the others. Historian Caitlin McCusker, at CH2M HILL, researched and wrote material for agriculture and road transportation. Architectural historian Carl McWilliams produced the Section on architecture. Michelle Slaughter, director of Avalon Archaeological Consultants, researched and contributed text to the section on tourism and recreation. CH2M HILL assembled and printed the document, integrating the context into the CSS planning process and coordinating with CDOT. As produced, the context and authors fulfill the requirements defined in Section IV of the Programmatic Agreement for the I-70 Mountain Corridor. The document was reviewed by Astrid Liverman (National and State Register Coordinator) and Amy Pallante (Section 106 Compliance Manager) of History Colorado and Lisa Schoch (Senior Historian, CDOT Headquarters).

Note that this document was initially developed as a Multiple Property Documentation Form (MPDF), which was reviewed by the Colorado Historic Preservation Review Board in May 2012. In October 2012, it was submitted to the National Park Service for review, but was

not finalized as an MPDF. It was subsequently re-formatted as a historic context, but retains the content developed for the MPDF.

CONTEXT DESCRIPTION

The history of the I-70 corridor is lengthy and complex. Between 1859 and 1962, numerous people, businesses, industries, and other entities populated the corridor, leaving a variety of historic resources still present today. The context is designed to structure identification and recordation of those resources, and establish guidelines for evaluating their significance according to the National Register of Historic Places (NRHP).

To do so, the context focuses on dominant historical themes within the corridor and related types of resources that are either common or otherwise significant. The themes, in order of presentation are: mining industry, timber industry, agriculture, electric power, railroad transportation, road transportation, and tourism and recreation. And yet, the course of history was not a uniform movement due to variance in geography, topography, climate, and natural resource distribution in the corridor's 120-mile length. For better accuracy, the context recognizes three principal segments in which the historic themes manifested slightly differently. Clear Creek drainage is the eastern-most. In this segment, the corridor encompasses Clear Creek valley between Floyd Hill in the east and Eisenhower Tunnel penetrating the Continental Divide at the west end. The dominant historical themes include mining and timber industries, electric power, railroad and road transportation, and tourism and recreation. The Blue River and Ten Mile Canyon region, in Summit County, represents the corridor's middle segment. The corridor descends west from the Eisenhower Tunnel to the town of Dillon, crosses the Blue River, and continues southwest past Frisco and into Ten Mile Canyon. The corridor veers west at Copper Mountain and crosses Vail Pass. The dominant historical themes are the same as those found in the Clear Creek drainage. The Eagle and Colorado river valley is the corridor's western-most and longest segment. The corridor descends northwest from Vail Pass to the town of Vail and assumes a westerly course, joining the Eagle River at the railroad town of Minturn. From here, the corridor follows the Eagle to its confluence with the Colorado at Dotsero, continuing through Glenwood Canyon to Glenwood Springs. The dominant historical themes include the timber industry, agriculture, electric power, railroad and road transportation, and tourism and recreation.

Context Function

Although the context was developed primarily to guide implementation of the Section 106 process, it was produced to meet the needs of the consulting parties and local interested parties as well. In overview, the document is divided into sections similar to chapters with Section A detailing corridor history by theme, and Section B defining common property types and resources and their registration requirements also by theme. The principal functions of the document include, but are not limited to:

- Supporting Section 106 compliance for projects that CDOT may undertake in the corridor.
- Providing information on regional history, common types of historic resources, and historic features for use with design and other phases of the CSS process.
- Supporting Section 106 compliance for projects that consulting party federal agencies, other than CDOT, may pursue in the corridor. Some of those agencies include the Bureau of Land Management and the U.S. Forest Service.
- Establishing guidelines for review agencies to access the accuracy and quality of Section 106 work in the corridor.
- Providing consulting parties with a document to help them understand the results of Section 106 findings for various projects.
- Supporting voluntary projects that consulting parties may undertake with individual historic properties in the corridor but outside of the I-70 right-of-way.
- Supporting large-scale voluntary projects that involve multiple historic resources, such as surveys and inventories.
- Offering material for heritage tourism development, primarily by consulting parties local to the corridor.

Format and Content

Following are points regarding the organization of content:

- The context includes information for users who are unfamiliar with the history of the corridor and its common types of historic resources.
- The context divides the corridor into the principal historic themes for which historic resources remain.
- The history of each theme is discussed in detail in Section A and covers time, place, important events, and significant people and institutions.
- The common types of resources likely to be encountered in the corridor are described in detail in Section B. Although no formal field surveys have been completed for this context, the resource types are forecasted according to corridor history, informal observations, and cultural resource work completed to date.
- The context establishes guidelines for evaluating eligibility of historic resources to the NRHP. Each resource type is treated independently, within each theme.
- Sections C through F contain supporting information including a description of the geographic area of the I-70 Mountain Corridor, the research methodology, bibliographic sources, and illustrations.

Limitations

The context possesses limitations in and restrictions for its use. Key limitations include:

- The context is not the mechanism for officially recognizing historic resources eligible for the NRHP. It serves as guidance document for recommending resources eligible and nominating them to the NRHP. FHWA, CDOT, OAHF, NPS, the BLM, and U.S. Forest Service possess authority for rendering official decisions regarding resource eligibility and nomination under their prevue.

- The context is not a binding or enforceable document for determining resources eligible, but provides structure and guidelines for their nomination. Decisions and findings of eligibility rest with the experience, judgment, and protocol of FHWA, CDOT, OAHP, NPS, BLM, or the U.S. Forest Service.

LIST OF COMMON ACRONYMS

AT&SF – Atchison, Topeka & Santa Fe Railroad
BLM – Bureau of Land Management
CB&Q – Chicago, Burlington & Quincy Railroad
CCC – Civilian Conservation Corps
CCRR – Colorado Central Railroad
CDOT – Colorado Department of Transportation
COC&PP – Central Overland California & Pike’s Peak Express Company
C&S – Colorado & Southern Railroad (successor to DSP&P)
CWA – Civil Works Administration
DL&G – Denver, Leadville & Gunnison Railroad (successor to DSP&P)
D&RG – Denver & Rio Grande Railroad
D&RGW – Denver & Rio Grande Railroad (successor to D&RG)
D&SL – Denver & Salt Lake Railroad
DSP&P – Denver, South Park & Pacific Railroad
FHWA – Federal Highway Administration
GB&L – Georgetown, Breckenridge & Leadville Railroad
ICC – Interstate Commerce Commission
MPDF – Multiple Property Documentation Form
NPS – National Park Service
NRHP – National Register of Historic Places
OAHP – Office of Archaeology and Historic Preservation
PUC – Public Utilities Commission
PWA – Public Works Administration
RFC – Reconstruction Finance Corporation
UPRR – Union Pacific Railroad
WPA – Works Progress Administration

Section A 1.1: History of Mining in the I-70 Mountain Corridor, 1859-1942

Introduction

Sections A.1.2 and A.1.3 provide an overview of the two I-70 Mountain Corridor segments where mining was significant as an industry, Clear Creek drainage and the Blue River and Ten Mile Canyon region. The intent is to aid identification of related historic resources and provide context for recommending eligibility to the National Register of Historic Places. Section A 1.4 helps readers understand mining methods and technology. The Section's material was adapted from the Colorado statewide Multiple Property Documentation Form *The Mining Industry in Colorado* and *Historic Mining Resources of San Juan County, Colorado*.¹

Period of Significance, 1859-1942

Mining was among the most influential forces in modern development of the central Rocky Mountains. The industry played a fundamental role in the I-70 Mountain Corridor during the Period of Significance 1859 through 1942, directly influencing all other historical themes outlined in Section A. The industry in turn created principal markets for agriculture and forest products, and the resultant need for efficient transportation fostered the development of road and railroad networks in the central mountains. Investors arranged some of Colorado's earliest electrical grids to provide the industry with power and its communities with lighting.

Despite a role as an anchor industry, mining occurred in only two of the corridor's segments. Clear Creek drainage, in Clear Creek County, was most productive and longest-lived, extending west from Floyd Hill to Loveland Pass. The other segment, in Summit County, extends west from Dillon through Ten Mile Canyon to Copper Mountain.

The mining industry's Period of Significance began in 1859 with the discovery of placer gold at Idaho Springs. Within a short time, placer mining evolved into a hardrock industry that spread throughout Clear Creek drainage and over to Dillon and Ten Mile Canyon. The Period ended in 1942 when the federal government temporarily outlawed gold mining because it diverted labor and resources needed for World War II. The industry slumped and was no longer a major employer or economic contributor, and it never recovered after repeal of the ban in 1945.

The broad Period of Significance encompasses mining as a theme in the corridor, but the industry was not uniform in chronology, trends, and significance throughout. Clear Creek drainage and the Dillon and Frisco area experienced different evolutions with and narrower periods of development, explained the subsections below. Applicable National Register of Historic Places (NRHP) Areas of Significance include Architecture, Commerce, Community Planning and Development, Economics, Engineering, Exploration/Settlement, Industry, Law, Politics/Government, and Transportation. Level of significance is local, and could be statewide or national for some resources in Clear Creek drainage depending on further research.

¹ Jay Fell and Eric Twitty *The Mining Industry in Colorado Multiple Property Documentation Form* Denver: Office of Archaeology and Historic Preservation, Colorado Historical Society, 2008; Eric Twitty *Historic Mining Resources of San Juan County, Colorado Multiple Property Documentation Form* Denver: Office of Archaeology and Historic Preservation, Colorado Historical Society, 2010.

Section A 1.2: History of Mining in Clear Creek Drainage, 1859-1942

Introduction

January 1859 was a pivotal month in the history of the Rocky Mountain region. George Jackson discovered placer gold at the site of present-day Idaho Springs, sparking a mining industry that spread throughout Clear Creek drainage. The industry was formative during the first several years, limited to small parties and individuals recovering placer gold from Clear Creek and tributaries. Organized companies began dominating the placer deposits during the early 1860s, and hardrock mining gradually increased during the middle of the decade. Although placer mining was important, its duration was short. The hardrock industry by comparison held a position of great significance for decades, yielding gold, silver, and industrial metals including lead and zinc.

As a geographic entity, Clear Creek drainage was among the most important centers of gold, silver, and industrial metals mining in Colorado. Because of the industry, Clear Creek drainage and its sophisticated towns became a center of culture, social interaction, and commerce in the central mountains. Mining contributed heavily to the material wealth of Colorado, as well as personal fortunes of investors and property owners. Through its ties to complex economic and commercial systems, the industry fostered banking, farming, and manufacturing both within and outside of Colorado. A number of companies in the drainage also forwarded mining and metallurgical engineering.

When the drainage is examined closely, its history is complex because gold and the other metals occurred separately. The drainage's eastern portion, from Floyd Hill in the east to Empire in the west, primarily yielded gold. Most of the silver and industrial metals such as lead and zinc came from the western portion, Empire in the east to Loveland Pass. Both segments followed different historical patterns as economic cycles, political events, technological developments, and geological conditions affected gold mining differently from that of silver and industrial metals. It should be noted that there was some parallel development due to overlapping geology, close proximity, and shared institutions and individuals. Thus, except for the first several years, the two geographic regions are discussed under their own headings. Table A 1.1 charts periods of development, as well as relevant Areas of Significance and general historical trends for the eastern and western drainages.

Table A 1.1: Important Time Periods in Eastern and Western Clear Creek Drainage

Eastern Clear Creek Drainage			Western Clear Creek Drainage		
[Metals: Gold, Some Silver]			[Metals: Silver, Lead, Zinc]		
Period of Development	Areas of Significance	General Trends	Period of Development	Areas of Significance	General Trends
1859-1864	Commerce Community Planning & Development Exploration Industry Politics Transportation	Discovery Gold rush Placer mining Initial settlement Hardrock mining Collapse in 1864	1859-1864	Commerce Community Planning & Development Exploration Industry Politics Transportation	Discovery Exploration Gold rush Placer mining Initial settlement Transition in 1864
1865-1873	None	Industry operates at low level due to troublesome ore and lack of investment	1865-1874	Architecture Commerce Community Planning & Development Engineering Exploration Industry Transportation	Silver rush Hardrock boom First smelters built Industry grows Towns established Transition due to RR
1874-1893	Architecture Commerce Community Planning & Development Industry Transportation	Industry grows Railroad in 1873 Towns established	1875-1893	Architecture Commerce Community Planning & Development Engineering Industry Law and Politics Transportation	Peak production Industry boom Railroad in 1877 Towns established Silver policy
1894-1897	Architecture Commerce Community Planning & Development Engineering Industry	Hardrock boom Industry grows	1894-1897	Architecture Commerce Engineering Industry Politics	Silver crash Industry adjusts Region contracts Mining stabilizes
1898-1918	Architecture Commerce Engineering Industry	Peak production Industry boom Mining stabilizes Collapse in 1918	1898-1907	Commerce Engineering Industry	Industry contracts Population leaves Zinc recovery Mining stabilizes Mining declines
			1915-1920	Commerce Industry	Revival due to WWI Collapse in 1920 Industry unimportant
1919-1929	None	Industry at low level and unimportant			
1930-1942	Engineering Industry Commerce	Depression stimulates subsistence mining Jump in production Major revival Gold outlawed 1942			

Discovery and the Placer Boom, 1859-1864

The history of mining in Clear Creek drainage began not on Clear Creek, nor in 1859, but rather ten years earlier during the California Gold Rush. In 1850, a party of Georgians, including a number of Cherokees, trekked across the plains and camped on the Front Range's piedmont while en route to California. The party consisted of prospectors with experience gained in Georgia's goldfields, and they examined the area for placer gold out of curiosity. Party members struck gold-bearing gravel on Ralston Creek (in north Golden) and took note of the find, but the meager discovery did not detract from the lure of California. Unaware that rich gold deposits ironically lay a short distance west in the mountains, the party broke camp and continued their journey.²

After moderate success in California, the Cherokees returned to Georgia where gold miner William Green Russell learned of their Ralston Creek find. In 1858, Russell organized an expedition with two brothers and other experienced prospectors and approached the Rocky Mountains along the Arkansas River. John Beck also departed with a band of Cherokees familiar with the original prospectors who made the 1850 strike. Around the same time, John Easter organized a third party that traveled up the Arkansas. The Russell and Beck parties met on their Arkansas path, combined forces, and camped at the confluence of Cherry Creek and the South Platte River. There, they discovered traces of gold, and, after much effort, located a few profitable deposits. Word spread to the Easter party, near Pikes Peak, and they joined the growing prospectors' camp.³

The number of prospectors from the three parties exceeded the available placer deposits, and after much exhausting and fruitless effort, many returned east. When the returning prospectors relayed their unsatisfactory experiences, their cautionary stories were distorted into visions of gold waiting for shovels and sacks. The Midwest, mired in an economic depression, became inflamed with gold fever, giving rise to the great Pikes Peak Gold Rush of 1858. Before year's end, gold seekers congregated near the original discovery point at the confluence of Cherry Creek and South Platte, as hopeful individuals continued arriving. The small settlement was at first named Auraria, and subsequently Denver.

George Jackson was among those arriving in 1858, and he was better prepared than most for the overcrowded conditions and lack of profitable ground at the settlements. Jackson, cousin to Kit Carson, was born in Missouri in 1836 and went to California to mine placer gold at age sixteen. He tried farming after hard labor and little gold, returned home in 1857, but left again for Wyoming within a short time. At Fort Laramie, Jackson learned of the gold discoveries in Colorado. He quickly assembled a prospecting party and worked his way south along the Front Range to Auraria, where he surveyed the placer fields there, well east of the mountains. Discouraged, Jackson and several partners moved west to Arapahoe City, near present-day Golden, and pitched camp as winter began.⁴

Jackson's California experience served him well. He understood that the gold on the plains came from sources in the mountains, a fact that seemed to elude other prospectors. While they tarried about the piedmont, Jackson quietly planned to examine the mountain drainages, and unusually warm weather at the beginning of January 1859 granted him the opportunity. Jackson left Arapahoe City on the premise of hunting, ascended west into the hills, and dropped into Clear Creek drainage where the valley opened up, near Floyd Hill. He made camp on the valley floor near present-day Idaho Springs, and according to popular legend, was curious about the

² Stone, Wilbur Fisk. *History of Colorado, Vol. 1*. Chicago, IL: S.J. Clarke Publishing Co., 1918, 230.

³ Abbott, Carl, Leonard, Stephen, and McComb, David. *Colorado: A History of the Centennial State*. Niwot, CO: University Press of Colorado, 1994 [1982], 51; Stone, 1918:232, 234.

⁴ Brown, Robert L. *The Great Pikes Peak Gold Rush*. Caldwell, ID: Caxton Printers, 1985, 8, 26, 28.

river gravel, panned a sample with a tin cup, and found gold. In actuality, Jackson was prospecting with purpose and had to expend considerable effort to expose the deep gold-bearing gravel layers. With pan and shovel, Jackson made the first recorded gold discovery in the mountains on January 7, 1859. Thomas Aikens and party subsequently made the second mountain find in Boulder County on January 15, and B.F. Langley and John Gregory followed within weeks in Boulder and Gilpin counties, respectively.⁵

Jackson returned to Arapahoe City and informed only members of his party, who swore secrecy and formalized their partnership as the Chicago Mining Company. In April, Jackson led the party back to his discovery point, and they began an organized prospecting campaign. The party established camp at the mouth of what the members named Chicago Creek, where they struck a significant gold deposit. The partners had the valley to themselves for at least several weeks, until Jackson went east to Auraria to secure provisions. He had no choice but to pay in gold, which drew the attention of idle prospectors who followed Jackson back. Word of the discovery spread quickly.⁶

By the time Jackson's discovery became known, prospectors were already aware of the deposits found by Langley, Aikens, and Gregory during the winter. These three finds became centers of major rushes when the season opened, leaving Jackson's Diggings fourth in importance. Prospectors gathered around Chicago Creek at first, then followed Clear Creek for several miles and began working gravel at what they named Payne's and Spanish bars (see Illustrations A 1.2.1 – A 1.2.3). By May, around 300 miners were busy recovering gold with simple methods, primarily rockers and short sluices, which were more efficient than pans.⁷

The miners quickly found that mountain placers required extensive labor in cold water to reach the lower gravel layers where the gold settled. In general, placer deposits featured gold particles that natural weathering dislodged from a parent vein and washed into the nearest drainage. Over time, erosion and water flow sifted the heavy gold downward, where it accumulated in the lower strata of gravel and along the underlying bedrock. Valley floors, such as Clear Creek, required more digging than tributary drainages by as much as 20 to 30', but had the potential for richer and higher volume deposits. Thus, miners shoveled away the upper gravel levels, kept the tailings off their neighbor's workings, and moved the auriferous material to their sluices and cradles, all while standing in frigid water. Because of such labor, many miners settled for the lesser deposits along tributaries and valley sides.

Prospectors continued to arrive during the spring, presenting competition for claims and available resources. This threatened what had been a peaceful rush with friction and even violence, a pattern witnessed during the California Gold Rush. In response, miners met in May to bring order and establish the Jackson Mining District. Miners typically organized districts as a primitive form of frontier government, electing a governing board, establishing boundaries, and recording bylaws defining claim sizes and rules for staking and holding such. In some districts, laws also created a miner's court and punishment for common crimes. The Jackson district was important because it was among the earliest in both Colorado and the greater Rocky Mountain chain. Here, miners defined claim size as 50' along stream channels and 250' up the banks, granted discoverers two locations, and everyone else one claim. Because few precedents existed

⁵ Hall, Frank *History of Colorado, V.I.* Chicago, IL: Blakely Printing Co., 1889, 189; Hollister, Ovando J. *The Mines of Colorado*. Springfield, MA: Samuel Bowles & Co., 1867. [Reprinted by Promontory Press, New York, NY, 1974], 60; Fossett, Frank. *Colorado: Historical, Descriptive and Statistical Work on the Rocky Mountain Gold and Silver Mining Region*. Denver, CO: Daily Tribune, 1876, 21; *Tailings, Tracks, & Tommyknockers: History of Clear Creek County*. Denver, CO: Specialty Publishing Company, 1986, 7; Brown, 1985:26; Stone, 1918, V.I:238.

⁶ Brown, 1985:8, 26, 28; Hall, 1889:190.

⁷ Hollister, 1867:70.

at the time, these sizes differed from the claims in Colorado's other nascent districts and addressed placer deposits exclusively since few prospectors were aware of hardrock gold veins.⁸

Prospectors continued descending into the valley throughout the spring, and finding the best ground between Chicago Creek and Fall River occupied, moved west up the valley and developed claims almost in series along Clear Creek. Later in summer, the prospectors organized two more mining districts. One was the Downieville district, named after a rich placer center in California, and the other was the Griffith district, pioneered by the Griffith brothers.

George and David Griffith came to Clear Creek from the Gregory Diggings (present-day Central City), discouraged by the number of prospectors already there. When they arrived at Jackson's Diggings, however, they found conditions little better and moved up the valley to the confluence of main and South Clear Creek, well beyond the extant placer workings. Although the Griffiths were interested in placer gold, experience taught them to search for hardrock source veins as well. George and his father Jefferson mined in California for years prior to the Pikes Peak Gold Rush and learned that placer gold came from parent veins known as lodes. In 1857, they returned to their family in Nebraska, and George convinced his brothers to try their luck in Colorado the following year.⁹

Based on George's California experience and seeing miners scrape gold from surface outcrops at the Gregory Diggings, the brothers examined the sides of Clear Creek valley for similar vein formations. At the confluence, they found two that they claimed as the Griffith and Turner. Because the veins were exposed, weathering rendered the quartz fill friable and easy to run through sluices. The Griffiths also found a silver vein, but because gold commanded their interest, they ignored it as a novelty. Within ten years, however, silver mining would dominate the area.¹⁰

The Griffiths were not the only prospectors in the region who were aware that placer gold came from parent veins. Experienced Colorado pioneers Henry Allen, William N. Byers, William M. Slaughter, and Richard Sopris examined a number of veins along Clear Creek in May 1858. Discovery of the Albro Lode drew a few seasoned prospectors into the Downieville district, where they found several more veins. Of these, early Colorado historian Ovando Hollister observed: "Lodes were struck in the hills all along Clear Creek, prospects from which were very large, although these were generally taken from narrow crevices."¹¹ Like the Griffiths, surface miners gouged out the loose quartz fill, smashed it with hammers, and shoveled the material into their sluices. Although the quartz operations were unsophisticated, they were significant as a first step in hardrock mining.

When not processing gravel on their claims, the miners retired to their camps and attended to domestic activities. Most of those camps paralleled the placer workings along Clear Creek, and they consisted of little more than tents, dugouts, hovels of branches, and primitive log cabins. Where activity was heaviest, group camps evolved into the valley's first settlements. The camp of Jackson's Diggings grew at Chicago Creek, Spanish Bar materialized one mile west, and Downieville around two more miles west. Prospectors established Bloomington at the confluence of West and Main Forks of Clear Creek and named the growing settlement around the Griffith camp George's Town.¹²

⁸ Hollister, 1867:70.

⁹ Leyendecker, Liston E. *The Griffith Family and the Founding of Georgetown*. Boulder, CO: University Press of Colorado, 2001, 2.

¹⁰ Jessen, Kenneth. *Georgetown: A Quick History*. First Light Publishing, 1996, 1; Hollister, 1867:71; Leyendecker, et al., 2005:3.

¹¹ Hollister, 1867:71.

¹² Harrison, Louise C. *Empire and the Berthoud Pass*. Denver, CO: Big Mountain Press, 1964, 20; *Tailings, Tracks, & Tommyknockers*, 1986:1; Jessen, 1996:1.

Mill City, adjacent to and west of Downieville, differed from the other settlements, heralding the impending transition from placer gold to hardrock ore. Miners at the Albro and nearby veins passed through the surface zone of loose quartz, and, as they incised deeper, the quartz became blocky and difficult to pulverize by hand. Thus, a number of outfits constructed arrastras, primitive facilities for crushing the simple quartz ore and recovering the gold. An arrastra consisted of a circular stone floor, low sidewalls, and a capstan at center. A draft animal tethered to a harness beam walked a path around the floor, dragging muller stones to grind the ore. The sidewalls retained the material inside, where a miner periodically added water and mercury to amalgamate the gold as it was freed. The assemblage of arrastras east of Downieville was so noteworthy that individuals throughout the drainage referred to the associated camp as Mill City. The camp established an exemplary precedent as the drainage's first ore treatment center, although miners built a few arrastras elsewhere along Clear Creek.¹³

During the fall of 1859, most miners left the drainage. Some were afraid of becoming snowbound while others exhausted their claims and moved on to try their luck at the Gregory Diggings. A few stayed, however, worked when they could, and otherwise kept warm. Like the previous year, December and January were unusually mild, allowing miners in the eastern, lower portion of the drainage to continue work.

When the working season of 1860 broke, most original miners returned, along with a wave of Pikes Peak rush newcomers. Their numbers were higher than ever, turning over additional acreage with pick and shovel. Because of their inexperience, the majority was unfamiliar with the concept of parent lodes and hence paid them little attention. Still, the rush did bring prospectors knowledgeable about hardrock veins. These individuals not only discovered additional ore formations, but also organized companies to pursue the ore underground and erect the earliest mechanized mills. Spanish Bar joined Mill City as a nascent hardrock center when several outfits developed the Hukill and Gum Tree veins. The Badger State Mining Company and a Dr. Seaton then built the drainage's first two stamp mills. The Badger plant went up at Spanish Bar to process ore from the Hukill or Gum Tree, and Seaton erected his mill at Jackson's Diggings for his mine on Seaton Mountain. In function, a stamp mill served the same purpose as an arrastra: crushing ore to recover the gold. A stamp mill, however, relied on a battery of stamps instead of muller stones, pounding the ore much like mortars and pestles. The resultant sand and slurry flowed over copper tables coated with mercury, which amalgamated the gold. Water, flumed from Clear Creek, turned a waterwheel for motive power.¹⁴

Regardless of which mill was earliest, both the Badger State and Seaton signaled significant developments. First, they indicated that individuals with capital and some engineering knowledge had arrived in the drainage. Second, the mills were able to process higher volumes of resilient ore than arrastras. Third, these factors inspired confidence among other investors who, with additional mills, were necessary to bring hardrock mining to fruition.

In 1860, several crude prospectors' settlements began assuming roles as regional commercial and communication centers. Inhabitants formalized the largest as townsites with grids of lots and blocks, and entrepreneurs set up needed businesses. Sam Hunter, William L. Campbell, William E. Sisty, and William Spruance organized the Idahoe Town Company and platted a townsite on Idahoe Bar, a large gravel fan adjacent to Jackson's Diggings (See Illustration A 1.2.4). All received income from the venture and moved on to subsequent ventures.

¹³ *Tailings, Tracks, & Tommyknockers*, 1986:41.

¹⁴ Frost, Aaron. "History of Clear Creek County." *History of Clear Creek and Boulder Valleys, Colorado*. Chicago, IL: O.L. Baskin & Company, 1880, 277; Wickersheim, Laurel Michele and LeBaron, Rawlene. *Mine Owners and Mines of the Colorado Gold Rush*. Westminster, MD: Heritage Books, 2005, 109; Hall, Frank *History of Colorado V.3*. Chicago, IL: Blakely Printing Co., 1891, 313; *Tailings, Tracks, & Tommyknockers*, 1986:1; Hollister, 1867:114, 123.

Campbell surveyed the plat, reinvested his proceeds in a stage company, and became involved in mining during later years. Spruance spent his money prospecting and then opened a store in Georgetown. Sisty worked for several mining companies during the 1860s and helped organize the Denver & Pacific Road Company to complete a toll road over Berthoud Pass. Once Idaho was platted, Samuel D. Hunter opened the first store and F.W. Beebee established the Beebee House hotel and restaurant, a long-lived institution.¹⁵

As was typical of frontier mining towns, most if not all the buildings were simple and of log construction, with residences being smallest and commercial establishments largest. Several sawmills began producing lumber in 1860, but the material was incorporated into the town's architecture only to a degree because supplies were limited with most lumber going to mining structures. In town, commercial buildings were most likely the earliest recipients, primarily for false-fronts, floors, and roofs. The pattern held true for the drainage's other settlements, as well.

Although Idaho quickly became the principal settlement in the drainage, Spanish Bar, Downieville, and Mill City attracted mercantiles and other businesses. The new camp of Fall River, named after the tributary, attracted several mercantiles, a hotel, and post office. The most important new settlement was Valley City, later Empire, which grew in 1860 during a placer rush to the West Fork of Clear Creek. Prospectors organized the Union Mining District there and began naming the principal landforms in a contest of political party affiliation. Several individuals named the prominent peak to the northwest Lincoln Mountain after the President, and Democratic prospectors dubbed a peak to the east Douglas Mountain after Lincoln's electoral opponent. Republican S.F. Johnson countered with Covode Mountain, to the east, named for Republican Pennsylvania Congressman John Covode. Not to be outdone, Democrats named the mountain adjacent and south of Lincoln after their party. Republicans applied their affiliation to the adjoining peak. All these mountains later yielded gold and silver ore, which prospectors recognized as early as 1860.¹⁶

Repeating the pattern elsewhere in Clear Creek drainage, most Valley City prospectors sought placer gold, and fortunate ones found it on the flanks of Silver and Eureka mountains east of town. A few experienced individuals unearthed narrow gold veins, gouged out the surface quartz, and pursued the ore underground. Richard and Edward Bard, J.H. Smith, George Webster, and E R. Williams claimed the first vein in the area as the Iowa and organized the Union Mining Company to develop it. The workings of this and other mines were shallow but yielded enough ore to convince individuals with mechanical skills to build stamp mills. John Leeper erected the first, J.H. Coombs followed, and George L. Nicholls converted his sawmill into a stamp facility. As activity in the area increased, Nicholls, David J. Ball, and other early prospectors platted the townsite of Empire City to compete with Valley City, ultimately attracting most of the businesses.¹⁷

A short distance south, at the confluence of main and South Clear Creek, the Griffiths prepared for an anticipated rush. During the winter David returned east for brother John, father Jefferson, their families and needed equipment. The party met George in Central City during the spring and divided into two groups. One puzzled out how to freight their goods over the difficult terrain down to Clear Creek and to the Griffith Lode. The other, joined by William Renshaw, secured land around the confluence and organized the Griffith Mining District. The partners filed several homestead claims and staked the townsite of Georgetown to sell lots near their small hardrock operation. With no clearly passable wagon route from Central City to Clear Creek, the

¹⁵ Fossett, 1876:91; *Tailings, Tracks, & Tommyknockers*, 1986:1.

¹⁶ Hall, 1891, V.3:315; Harrison, 1964:24.

¹⁷ Harrison, 1964:27.

family invested in a road and recovered the cost by charging tolls. With hired workers, the family graded up Empire Gulch from Central City, down York Gulch to Fall River, over to Clear Creek, and along the valley to their townsite. In 1861, the Griffiths formalized their venture as the Central City & Georgetown Wagon Road Company to include outside investors for funding.¹⁸

The Griffiths completed the first wagon road into Clear Creek valley, rough as it was, and that road became a main point of entry. Investors then built another artery that made Idaho (spelling changed in 1860) a transportation hub. They graded the South Clear Creek Wagon Road from Bergen Park down to Idaho and the Idaho & Fall River Wagon Road from Idaho to the Georgetown road at Fall River. Although the primitive system was only a start, it revolutionized both the quality of life and the nascent mining industry because wagons could now deliver a wider variety of goods at lower costs than man or pack animal.¹⁹

As mining activity increased during 1860, hardrock discoveries combined with placer mining outside of stream channels overwhelmed the basic regulations defined by the various mining districts. In response, prospectors and miners met during the summer to revise claim codes and add definitions applicable to hardrock mining. Because no precedent existed, the miners adopted bylaws similar to those in Gilpin and Boulder counties. In these areas, Gulch Placer claims in stream channels were 50'x100' in area. Patch Placer claims, a term for gold-bearing soils outside of streambeds, were 100'x100' in area. Lode claims, staked over hardrock veins, were 50' wide centered on the vein, and 100' long. Tunnel claims provided rights to drive tunnels into a vein, and they were as wide as a tunnel and as long as necessary. If a tunnel inadvertently penetrated a hidden lode, operators could claim 250' segments in both directions. Millsite tracts were 250'x250' in area, and permitted the owner to cut ditches and races for waterpower through adjoining properties. Water claims allowed measured volumes of water to be diverted from a stream for power and placer mining, and when the flow was insufficient for all users, the first to obtain a right had seniority, no matter their location. When the federal government recognized the Territory of Colorado in 1861, legislature codified these regulations and enforced them until superseded by the 1872 mining law.²⁰

Official designation of Colorado as a territory impacted Clear Creek drainage in other ways. First, the territorial legislature designated seventeen counties, including Clear Creek with Idaho as county seat. County residents now had political representation. Second, the federal government increased its protection of trans-plains supply routes against Native American tribes. Previously, ties with commercial centers in the Midwest had been tenuous, which slowed growth in Colorado. With the routes more secure, higher volumes of goods and expertise arrived in the territory, and the Post Office Department began regular, reliable delivery. The mail's importance to the drainage cannot be understated because it was the principal form of communication between individuals, companies, and their contacts in the East. New post offices in Mill City and Empire City provided these communities with similar boosts. Although Idaho was the county seat and continued to grow, it was not granted a post office until 1862, a year later than the other two towns.²¹

The improved conditions increased confidence among Eastern investors and drainage residents, as did the wave of hardrock discoveries and new mills. The western drainage was a center of activity in 1861, and many prospectors pitched camp in the Griffiths' townsite. Because

¹⁸ Leyendecker, Liston E., Bradley, Christine A., and Smith, Duane A. *The Rise of the Silver Queen: Georgetown, Colorado, 1859-1896*. Boulder, CO: University Press of Colorado, 2005, 6; *Tailings, Tracks, & Tommyknockers*, 1986:23; Jessen, 1996:2; Leyendecker, 2001:9, 48.

¹⁹ *Tailings, Tracks, & Tommyknockers*, 1986:95.

²⁰ Fossett, 1876:26, 29, 90, Frost, 1880:276; Hall, 1891, V.3:313; Hollister, 1867:358.

²¹ Bauer, William H., Ozment, James L., Willard, John H. *Colorado Post Offices: 1859-1989*. Golden, CO: The Colorado Railroad Museum, 1990, 98.

the area was not rich with placer gold, prospectors turned their attention to hardrock veins. They located seventy-five lodes and staked 2,000 to 3,000 claims, and although most were unprofitable, several yielded ore. To treat the small batches of payrock from the new mines, William Davidson built Georgetown's first mill, which featured only three stamps, and another interest erected a second mill within a short time. The Griffith Mine, among the most important operations, included a third mill and aerial tramway to lower ore down from the workings. The system consisted of two buckets, suspended from a rawhide rope, acting in tandem. One bucket was at the mine, the other at the mill, linked by a rope passing around a pulley. When the Griffiths lowered a filled bucket from mine to mill, it pulled the other, empty vessel up. They filled the bucket before them, lowered it to the mill, and received the other, now empty, at the mine. The Griffiths repeated the process, back and forth, until they sent all ore down to the mill. The system, however primitive, appears to have been the first aerial tramway in the Rocky Mountain region.²²

Mining continued as before during 1862, but several changes began to develop. The most important involved placer deposits, the basis for nearly all meaningful gold production at the time. The thinnest layers of gravel showed signs of exhaustion, and miners had to dig deeper in thicker beds. It appeared that the easy gold neared an end in those areas worked since 1859.

The second important change involved the drainage's other source of gold, hardrock veins. Although they yielded only a fraction of the hundreds of thousands of dollars produced from placer gravel, lodes increasingly drew the interest of both prospectors and investors. The Union district, in particular, developed into a center of hardrock claim development, and the discovery of particularly rich veins incited a rush during 1862. In sluicing gold-laden soils off Silver Mountain, James C. Huff and partners exposed the Tenth Legion Lode, and Charles A. Martin and George L. Nuckolls unearthed the Great Equator Lode. Afterward, other seasoned prospectors found the Pioneer, Silver Mountain, Livingston County, and Benton. William H. Russell, among early investors, acquired other profitable claims, built a stamp mill, and produced gold bullion. Russell had a vested interest in the industry's success because his Central Overland California & Pikes Peak Express Company hauled considerable tonnage of freight into the region. Empire City grew in response and approached Idaho in size and importance during 1862. (See Illustration A 1.2.5) The town boasted seventy buildings, multiple businesses, and specialty establishments such as a brewery, butcher, and brickyard.²³

Depletion of the shallow and easily extracted placer gold hastened the transition from surface to hardrock mining. Miners exhausted more placer claims than ever in 1863, and a large number of seasoned miners left for better goldfields elsewhere, even as a few late-comers still trickled into the drainage. The population in Mill City fell so low that the Post Office Department revoked its station there in 1863. Localized mining was on the brink of collapse.²⁴

Meanwhile, Eastern investors became keenly interested in hardrock mining in the West, including Colorado, due to several reasons. First, capitalists sought economic stability in gold as the Civil War disrupted the national economy. Second, as the Union Army established a firm presence on the plains, it improved the reliability of overland routes and made the Rocky Mountains more accessible. Finally, a handful of promoters went East and drew investors' awareness to Colorado, whose gold mines began to command a premium interest. Russell personally represented Clear Creek drainage, taking samples of gold from his Empire City properties to New York City. Promoters offered glowing accounts of their properties, natural

²² *Georgetown Courier* (3/23/35): p1 c2; Leyendecker, 2001:17; Leyendecker, et al., 2005:10.

²³ Fossett, 1876:92; Harrison, 1964:93; *Tailings, Tracks, & Tommyknockers*, 1986:95; Leyendecker, et al., 2005:12; Wickersheim and LeBaron, 2005:121, 130, 139.

²⁴ Bauer, et al., 1990:98.

resources, sizes of the veins, and assay values of the ore. They failed to mention, however, that their properties had no infrastructure, the veins were undeveloped, and the extent of available ore was completely unknown. Further, promoters and investors alike grossly underestimated the cost of running a mine in the remote Rocky Mountains, as well as the length of time between breaking ground and realized income. The result was a short-term gain in capital investment and property development, which temporarily saved Colorado mining from collapse, but created conditions for disappointment in the long-run.

Inexperienced and overly optimistic investors organized mining companies, blindly purchased claims, and dispatched officials and supplies to Colorado. In many cases, the companies lacked funds and merely sold stock to individuals eager for gold. Of the trend, early Colorado historian Frank Fossett noted: “Agents were sent out to Colorado to hunt up and purchase mining claims. It is evident they were not very particular as to the value thereof so long as they could show evidence of a record or transaction of some kind.”²⁵ In Clear Creek drainage, Idaho and Empire City featured the most veins and saw the greatest amount of activity. Companies bought many veins between Idaho and Fall River and built a few mills near those that already existed. At Empire, the Knickerbocker Gold Mining Company bought the Tenth Legion, and the Bay State Mining Company began the Aorta and Bay State tunnels to develop the Livingston County. Both outfits also built mills.²⁶

In developing Colorado properties, few if any company managers and engineers had practical models to emulate because mining in the West was new. They adapted industrial practices and management strategies from the East, which were of limited use in the rugged and remote Rockies. Unaware that many gold veins were shallow and offered little ore, they invested capital in unnecessary tools, buildings, and even large mills. Further, many mills were equipped with processes that had not been vetted on Clear Creek ore. Fossett succinctly observed: “The working capital was usually expended in building a mill of some kind, instead of on the claim to see if it had anything that called for a mill.”²⁷ The over-promotion of properties, underestimation of costs, inept management, and expensive construction ahead of vein development positioned many operations for failure. This pattern plagued the mining industry for decades to follow.

The conditions for failure caught up with the young hardrock industry after only one year. The veins in the drainage, the companies that bought them, and external conditions were to blame in varying combinations. Most veins either lacked ore rich enough or pinched out at shallow depths. The few veins of substance offered ore easily crushed and gold that readily amalgamated. Between 100’ and 200’ below the surface, however, the ore changed character and included pyrite and sulphur compounds that resisted amalgamation. While assays indicated that such ore was rich, it could not be milled with conventional methods. Thus, some mines possessed ore with high assay values but unprofitable to produce.

Other factors worsened a growing crisis. Native American tribes began a campaign to disrupt trans-plains traffic, which interfered with freighting and communication. In Clear Creek drainage, floods caused by a wet spring damaged towns, roads, and mines. As a result, companies suffered construction delays and increased operating costs, and were unwilling to ship gold back East to satisfy investors. After a year of stock assessments but no gold, investors balked at further requests for capital and froze their respective companies. Clear Creek drainage entered a deep depression in 1864. The placer boom was over, hardrock mining failed to deliver, and more people left the region. A few companies still operated near Spanish Bar and Empire,

²⁵ Fossett, Frank. *Colorado: Its Gold and Silver Mines, Farms and Stock Ranges, Health and Pleasure Resorts*. New York, NY: C.G. Crawford, 1880, 133.

²⁶ Harrison, 1964:139, 161.

²⁷ Fossett, 1880:135.

but they were unable to carry the region alone. Empire succumbed to the same problems as the rest of the drainage and went bust in 1867.²⁸

Silver Boom in the Western Drainage, 1865-1874

Gold, and gold alone, commanded the attention of miners and investors during the first five years of development in Clear Creek drainage. Most wealth-seekers in their inexperience focused on placer deposits, but a small proportion of prospectors were knowledgeable enough to examine the mountainsides for parent veins. Although these prospectors sought gold, a few in the western drainage inadvertently encountered silver. The Griffiths, in particular, found the ore near their camp of George's Town, James Huff likewise at the Ida Lode near Empire, and others identified more silver in the same area. They noted their discoveries but did little with them because gold was more valuable at \$20.70 per ounce and recoverable with crushing and mercury amalgamation. Silver, on the other hand, fetched around \$1.20 per ounce, occurred in harder rock, and required smelting to separate. In 1865, several events came together that stimulated a silver rush leading to major industrial development (see Illustrations A 1.2.6 - A 1.2.8).

The excitement ironically began with the discovery of more silver ore outside the drainage. Huff, Robert Steele, and Robert Taylor, prospecting partners at Empire, organized an expedition to search for gold in the Snake River drainage, Summit County, in 1864. They planned a route through George's Town, southwest up Leavenworth Creek, west over what became Argentine Pass on the Continental Divide, and down to the Snake River. Huff and Steele were well-qualified to find both placer gold and its hardrock parent veins. Huff arrived at Empire in 1860, developed several gold veins, and spent time exploring high altitude areas. Steele epitomized the Rocky Mountain prospector of the 1860s. He was born on an Ohio farm in 1820, left at age 26 to study law in Iowa, establishing a practice in 1852. After three years, Steele and wife moved to Omaha, became involved in real estate, and Steele was elected to the Nebraska Territorial Legislature in 1858. The allure of gold proved stronger than politics, and he joined the Pikes Peak rush after only one year. Steele tried mining near Central City but found his skills as a lawyer and politician more lucrative. He and other early prospectors started a movement to carve Jefferson Territory out of Kansas and Nebraska, and although elected provisional governor, the effort failed and he never took office. Steele and partners also organized the Rocky Mountain Company, which dug one of the earliest community ditches at Central City to deliver water to their placer claims and sell the surplus, in great demand. The gold excitement at Empire drew him to upper Clear Creek drainage in 1862, where he met Huff.²⁹

As Huff, Steele, and Taylor approached the Continental Divide in 1864, they made camp at the head of Leavenworth Gulch and began prospecting. Huff, already experienced with silver ore from his Ida claim, found an obvious and rich silver vein on the gulch's west side. The partners staked it as the Belmont, organized the Argentine Mining District, and began shallow development work. When Huff began a journey east for capital, other prospectors learned of the discovery as he passed down the drainage. Although some individuals hastened up to Leavenworth Gulch, interest developed slowly because few understood silver, and the working season was nearly over. Lorenzo M. Bowman was among those who responded quickly, and mining lead in Missouri gave him the experience to recognize silver ore, which had a lustrous and gray appearance. Bowman, among the few free African-American prospectors in the region,

²⁸ King, Joseph. *A Mine to Make A Mine: Financing the Colorado Mining Industry, 1859-1902*. Texas A&M University Press, 1977, 18, 19; Fossett, 1880:135; Hollister, 1867:138.

²⁹ *History of Clear Creek and Boulder Valleys, Colorado*. Chicago, IL: O.L. Baskin & Company, 1880, 538; Fossett, 1876:31.

staked the Square and Compass lodes, among the richest in the district. Huff, Bowman, and others demonstrated that there were silver veins at treeline southwest of George's Town.³⁰

When the working season of 1865 opened, prospectors stampeded to the new district. Although they would have preferred gold, the collapse of mining in Clear Creek drainage presented most with the choice between a local search for silver or leaving altogether. In addition, the demand for silver increased as the Union sought economic resources to offset the cost of the Civil War.

As typical of rushes, the army of prospectors staked a patchwork of claims around known veins, most of which were on McClellan Mountain, a ridge of exposed rock on the gulch's west side. At the same time, the prospectors pitched camp on the floor of Leavenworth Gulch, and the collection of tents quickly evolved into the town Argentine. Prospectors continued to arrive during the summer of 1865, and finding the gulch already claimed, wandered farther afield in search of open ground. Such was the case with Richard C. Irwin, Jack Baker, and William Fletcher Kelso, all experienced frontiersmen. With McClellan Mountain overrun, they descended the steep west face into a glaciated gulch they named after Kelso (present-day Grizzly Gulch). The chasm descended northerly for one mile and joined the main fork of Clear Creek. On Kelso Creek's east side was McClellan Mountain, and on the west side stood a pyramidal peak named after Kelso as well. As the first Euro-Americans to explore the drainage, the prospectors discovered the Baker Lode on Kelso Mountain, proving that more silver veins lay west of the concentration on McClellan Mountain. The party sold their claims to Pennsylvania investors for a handsome sum in 1866, and Irwin went on to become one of the most iconic prospectors of Colorado while Kelso settled in Georgetown and thrived with the mining industry.³¹

Once the Argentine district became filled, prospectors no longer bothered with the ascent up Leavenworth Gulch and instead turned to the mountains around George's Town. Some reasoned that if silver existed at Argentine, they might find similar veins along Clear Creek, just as the Griffiths did. Leavenworth Mountain, gateway to the Argentine district, was a natural place to start, and prospectors quickly claimed the O.K. and Saco lodes. Individuals demonstrated that yet more silver veins existed in the mountains on the northwest side of Clear Creek. John Cree discovered the Henry Ward Beecher on Democrat Mountain, Anderson Orr found the Elijah Hise on Sherman Mountain, and others found additional lodes in the area. All began yielding ore within a short time.³²

Although George's Town was central to the rush, the settlement grew slowly at first. Most of the prospectors either passed through on their way to Argentine or camped at their claims in the surrounding mountains. Several mercantiles, the Griffith cabins, and the mills built earlier anchored the growth. In 1865, William M. Hale claimed a 160-acre tract adjacent to George's Town with several possibilities in mind. He forecasted that the rush would create opportunities for trade and platted Elizabethtown to compete with George's Town, now known as Georgetown. Hale also built the What Cheer Mill to treat silver ore for the Alpine Gold Mining Company, as well as custom batches from other outfits. James O. Stewart also foresaw the need for ore treatment, building the Stewart Reduction Works at the mouth of Leavenworth Gulch.

The Stewart works differed in process from the What Cheer plant, but both facilities were tiny and experimental. The What Cheer was a stamp mill that relied on amalgamation to recover

³⁰ "Clear Creek County" *Rocky Mountain Mining Review* (6/26/84): 1; Frost, 1880:278; Hollister, 1867:252; *Georgetown Courier* (1/14/28): 1 c6; Leyendecker, et al., 2005:21, 70.

³¹ Ellis, Erl H. and Ellis, Carrie Scott. *The Saga of Upper Clear Creek: A Detailed History of an Old Mining Area, Its Past and Present*. Frederick, CO: Jende-Hagan Book Corporation, 1983, 54; Fossett, 1876:99.

³² Fossett, 1876:99; Wickersheim and LeBaron, 2005:128.

silver, while the Stewart was a true smelter. Amalgamation was effective for simple silver ores, but material from the Argentine and Griffith districts proved to be too complex. The ore required smelting, and although Stewart had difficulties with the ore as well, his smelter was the first and most successful of the initial silver plants.³³

The rush to Argentine resumed during the working season of 1866, and the Griffith district around Georgetown began attracting as much attention. Prospectors continued finding silver veins, and a rich strike at the Anglo Saxon, on Saxon Mountain, created a local sensation. But local mining outfits and millmen realized that silver presented technological problems that the gold miners down-valley shared only in degree. One was the geological structure of the silver ore formations. The veins tended to be narrow, inconsistent, hard, and encased in very dense metamorphic rock. Such formations required considerable underground exploration to track and planned development to block out for extraction. The dense rock also slowed drilling and blasting, which miners did by hand to advance their workings.

The other problem, whose solution was elusive, was separating silver bullion from the vein material, known as gangue. Gold ore merely had to be crushed, screened, and amalgamated with mercury. Silver ore from Clear Creek, by contrast, required roasting, crushing, screening, and then smelting in a furnace. Smelting was not straightforward because no one had yet developed furnaces truly designed for Clear Creek silver. The ore had to possess certain characteristics, proportions of lead and silver, and purity in order to melt. In many cases, workers started the process by hand-sorting the ore first to remove inferior material. When operating a smelter, the metallurgist had to pay explicit attention to the furnaces and adjust them for specific batches of ore.

Formal mine development and successful smelting were beyond the abilities of most small outfits and self-made entrepreneurs. They could only be accomplished with expertise, capital, equipment, and wage labor, which was the domain of organized companies backed by investors. In 1866, the number of such companies reached the critical mass necessary for silver mining to become an industry. That industry, however, struggled at first. Compared to recovering silver, extracting the ore was easy, although the mountain terrain, remote locations of the mines, and especially the climate made even this difficult. Winning silver from the vein material was by far the most troublesome and ruined many investors. The What Cheer Mill and Stewart Reduction Works (see Illustration A 1.2.9) were the first two silver-specific ore treatment facilities, offering would-be metallurgists some guidance. Amalgamation proved to be a failure, but smelting offered potential if a plant could be correctly designed.

In 1866, mining and ore treatment companies built a total of five new smelters and refitted the What Cheer Mill. At Elizabethtown, J.W. Watson built an experimental smelter for the Baker Silver Mining Company to test ore from the Baker Lode. The Georgetown Silver Smelting Company, managed by John T. Herrick, also erected a small smelter. The Argentine Silver Mining & Exploring Company, under Caleb S. Stowell, ran a plant with hearth and rotary furnaces to treat Argentine ore. At Georgetown, John Cree and the Bohemia Smelting Company had a furnace in operation to treat galena from his H.W. Beecher Mine. Bowman and other African-American partners organized the Red, White, & Blue Company to develop the Square and Compass and operate a small smelter.³⁴

The What Cheer Mill was an exception to the wave of new smelters. Erasmus Garrett, Charles A. Martine, and Dr. G.W. Buchanan established Garrett, Martine & Company, leased the plant, and converted it into a chlorination works. Chlorination was an alternative to mercury

³³ Fossett, 1876:322; *Georgetown Courier* (1/7/28): p1 c6; *Georgetown Courier* (1/21/28): p1 c4; Jessen, 1996:9; Leyendecker, et al., 2005:28.

³⁴ Fell, James E., Jr. *Ores to Metals: The Rocky Mountain Smelting Industry*. Lincoln, NE: University of Nebraska Press, 1979, 58; Fossett, 1876:100; *Georgetown Courier* (1/14/28): p1 c6; Leyendecker, et al., 2005:70.

amalgamation, and, based on his formal training in chemistry, Martine assumed that the process would work on relatively pure silver ore. Buchanan and Garrett provided the capital to refit the mill. Some of the smelters functioned correctly at first, but most did not. Supposedly, the What Cheer chlorination facility produced the first silver bricks in Colorado, but this is questionable because the Stewart Reduction Works had already been in operation for a year. It appears that Bowman may have enjoyed the greatest success because of his practical experience with smelters in Missouri. Not only was Bowman's Red, White, & Blue smelter effective, but also apparently saved Caleb Stowell's Argentine Silver smelter.³⁵

Among the first attempts at smelting ore was that of Caleb Stowell. He brought a Scotch hearth furnace from Galena, Ill., and erected it near the mouth of Leavenworth gulch. Stowell was a novice in the business and his first attempt was a failure. Frank Dibben, who was something of a metallurgist, made Stowell a bet of \$500 that he could run out a pot of lead in 24 hours. The bet was accepted. Dibben went to the furnace, locked the door and commenced work. He, too, found that he was a novice in practical work. He labored all day but the lead would not flow. Dibben was on the point of giving up the attempt, when Bowman came along and peeked through a crack to see what was going on. In the broadest dialect he informed the operator that he could never melt the ore with that color of flame. 'What in ____ do you know about smelting lead?' asked Dibben. Bowman replied that he had worked in the lead smelters of Missouri for twenty years. Dibben offered him ten dollars if he would smelt the ore. Bowman went to work, cleaned out the furnace, put in a new charge, and within two hours had a stream of lead flowing. The bet was compromised, but from that time until his death, which occurred on Dec. 24, 1870, Bowman was always addressed as 'Professor.'³⁶

Ultimately, the smelters failed one by one for several reasons. First, most were based on designs used to treat lead ores in Missouri, Iowa, and Wisconsin. Lead was soft and melted much more easily than the complex ores of the Argentine and Griffith districts. Second, some of the smelters were marginally successful, but only because the silver ore came from shallow workings and was oxidized. As with hardrock gold in the eastern valley, the silver ore increased in complexity and became resilient at depths between 100' and 200'. Until metallurgists overcame problems presented by refractory ore, mining outfits had to restrict their production to the upper reaches of their veins.³⁷

In 1866, the fathers of Georgetown and Elizabethtown decided that cooperation was in their best interest instead of competition; the towns merged. The Post Office Department opened a post office under the name of Georgetown, and Charles C. Churchill began regular stage service to Idaho Springs. William Barton erected the Barton House hotel, which offered accommodations capable of satisfying visiting investors. Other residents built around sixty houses and cabins during the year. Overall, the combined settlement grew in importance and replaced Empire as the commercial, communications, and ore treatment center for western Clear Creek drainage.³⁸

Between 1867 and 1869, the boom in the Griffith district evolved from a rush of prospectors into a rush of investors, industry experts, and other entrepreneurs. During this timeframe, the district possessed characteristics typical of the mining frontier.

Prospectors continued to arrive in substantial numbers. They examined the mountains around Argentine and Georgetown and claimed mineral formations that merely hinted of silver. They climbed Saxon, Griffith, and Independence mountains lining the east side of Clear Creek

³⁵ Fossett, 1876:100, 328; Frost, 1880:340; "Obituary" *Engineering & Mining Journal* (7/7/00): 17.

³⁶ *Georgetown Courier* (10/28/33): p1 c5.

³⁷ Fell, 1979:58.

³⁸ Bauer, et al., 1990:60; *Tailings, Tracks, & Tommyknockers*, 1986:95; Hollister, 1867:258; Leyendecker, et al., 2005:32.

valley. On the north side, prospectors sought silver on Douglas, Columbia, and Democrat mountains. Like the gold outfits several years earlier, most companies and investors were legitimate but ill-advised, some were frauds, while a few struck it rich. As typical of early stage booms, prospectors worked side by side with organized companies trying to prove the existence of ore, and all operations were small and primitive.

Both prospectors and organized companies did well on the main fork of Clear Creek, west of Georgetown. Prospectors crowded out of the Georgetown area shifted to the north side and found silver on Republican, Sherman, and Brown (renamed Silver Plume) mountains. As at Georgetown, some prospectors conducted their own development work while others sold to companies. Most of the prospectors and mining company employees, often one and same at different times, lived on the valley floor in several camps. The largest collection of tents and cabins grew at the mouth of Brown Gulch, and residents referred to the camp as Brownville. In 1869, Ambrose H. Bartlett and Charles A. Kimberlin formalized the second concentration a short distance east as Silver Plume. They platted a townsite claim and constructed several buildings including a school to attract a working population. Families were few in the area at the time, but community organizers understood that the industry would depend on them once established.³⁹

A mining industry materialized not just around Silver Plume, but also throughout the greater Griffith district. Companies began applying their capital to operations that were formally engineered and capable of generating ore in meaningful tonnages. To this end, Frank J. Marshall forwarded what became a common template for claim consolidation and development. Marshall was born in Virginia in 1816, moved to frontier Missouri at age twenty-six, travelling farther west into Kansas Territory during the early 1850s. He platted the townsite of Marysville, after his wife, in what became Marshall County. Marshall served in the territorial legislature during the violent anti-slavery Free State period, was general in the state militia, and elected governor of what became the state of Kansas in 1856. Marshall then joined the Pikes Peak rush, ran a freighting outfit and mercantile in Denver, moved to Central City in 1864, and invested in several profitable mines. He saw opportunity in the Georgetown boom, relocated, and began buying proven claims on Leavenworth Mountain. In 1868, he and D. Ernest Foster organized the Marshall Silver Mining Company, consolidated the claims, and began driving the Marshall Tunnel to undercut a rich vein system at depth. Through deep development, miners could block out the veins, work them from the bottom up, use gravity to draw the blasted ore down into bins, and haul the material out the tunnel. Known as a haulageway, the tunnel was an enormous engineering and financial success when finished and functioned for around forty years.⁴⁰

Charles Burleigh had a similar intention when he began the Burleigh Tunnel (see Illustration A 1.2.10) at Brownville. He acquired several rich claims, planning on using the tunnel to extract his own ore as well as offering rights-of-way to owners of adjoining claims for subscription fees. Burleigh found that the extremely hard granite country rock impeded progress and experimented with steam drills to bore blast-holes instead of traditional hand methods. Such drills had only recently been developed, and Burleigh was among the earliest to adapt them to mining. Because the drills were ungainly and undependable, Burleigh developed his own model, known as the Burleigh, and created a design that the industry adopted around ten years later. Burleigh's operation was a major capital investment and an important step in the industrialization of upper Clear Creek.⁴¹

³⁹ Leyendecker, et al., 2005:87, 171.

⁴⁰ Fossett, 1876:359; Frost, 1880:320; Hall, 1889:256; *History of Clear Creek and Boulder Valleys*, 1880:519; Wickersheim and LeBaron, 2005:123.

⁴¹ Fossett, 1880:396; Leyendecker, et al., 2005:128.

Joseph W. Watson established the Brown Silver Mining Company to develop the U.S. Coin and John Brown claims above the Burleigh Tunnel. After developing its section of the vein, the company built two tram systems to lower ore down to the valley floor, which eliminated costly and slow mule trains. One system was an aerial tramway and the other an inclined rail line with specially designed car. Colorado had few of either during the late 1860s.⁴²

Metallurgists and smelting companies invested capital and applied engineering to treat the ore bought down from the growing number of mines. Several companies built new smelters, and although most failed, a few were successful. Watson commissioned two of the new plants in 1867 for companies he represented. He built one at Brownville for the Brown Silver company, and that smelter was apparently patterned after ineffective Missouri designs with their hearth furnaces. The costly tramway noted above delivered crude ore to the smelter, workers sorted and reduced the cobbles, loading them into the smelter furnace. Much to Watson's disappointment, the ore did not feature enough lead to melt properly. Instead of scrapping the affair, Watson imported lead from Chicago at great cost in hopes that it would serve as a flux and encourage the silver to melt. Watson tried over the course of three years and bankrupted the company in the process.⁴³

Watson's second smelter was also a failure, but it anchored growing activity in the upper reaches of the main fork of Clear Creek. After testing ore for the Baker Silver Mining Company at the experimental furnace in Georgetown, Watson convinced investors to fund a full-scale plant where Kelso Gulch (now Grizzly Gulch) emptied into upper Clear Creek, to be closer to the Baker Mine. The facility became seed for a camp of several company buildings and a station where wagons brought ore down. Known as Bakerville, the settlement quickly attracted a mercantile and Edward Kennedy's sawmill. After the Baker Silver Mining Company spent a considerable amount of money, however, the operation failed in 1870. At first, the company was unable to produce enough ore, and Watson then attempted to keep the smelter running by soliciting custom business from independent producers, but it was too far from Silver Plume to justify their trouble. When the company finally began production of substance, the smelter proved inefficient and closed. Bakerville survived, however, evolving into one of Clear Creek's principal sawmill centers during the 1870s.⁴⁴

James Herrick and Georgetown Silver Smelting Company had similar problems with its plant. After Herrick realized that the smelter was ineffective, he leased it to metallurgist and inventor Charles Bruckner, who used the facility to test a revolutionary rotary furnace of his own design. The furnace featured an inclined steel cylinder lined with fire brick, which rotated while a jet of superheated gases generated in a stationary hearth traveled through. The gases were supposed to melt ore loaded into the top, with molten metals and slag trickling out the bottom. Although the concept worked with soft ore, Bruckner found that it was not suited for the resilient material in the Griffith district. He abandoned further efforts only after installing another rotary furnace at Bakerville for Watson with equally poor results. These and other smelter failures clouded the Griffith district's reputation, ruined a few investors, and bankrupted companies, but were important in identifying truly effective ore treatment methods.

The development of a primitive infrastructure was a defining characteristic of the Griffith district boom, just as for the eastern valley years earlier. On the raw frontier where roads had not yet been graded, people often moved about on foot or horse and carried freight on trains of mules or donkeys. In successful mining areas, by contrast, wagons hauled freight by the ton instead of

⁴² Leyendecker, et al., 2005:126.

⁴³ Fell, 1979:60; Fossett, 1876:338, 348; Leyendecker, et al., 2005:72.

⁴⁴ Ellis and Ellis, 1983:60, 208; Fossett, 1876:101.

by parcel or crate, and stages and omnibuses shuttled multiple people at once. These vehicles required roads, while railroad service was the ultimate link with the wider world.

In the Griffith district various interests combined the above transportation methods in a circulation system of roads and packtrails. A basic network of roads allowed wagons to move between points of industry and commerce while packtrails fanned out to mines and prospects in the mountains. The Griffith family had already established a toll road east to Fall River, which served as a principal along upper Clear Creek. In 1866, the Georgetown & Argentine Wagon Road Company extended the road up to Argentine, and Joseph Watson graded a branch through Silver Plume and up to the Baker Mine. In 1867, Watson organized the Georgetown & Breckenridge Wagon Road Company to improve the road with an option to continue over the Divide and into Summit County. The following year, Stephen Decatur formed the Georgetown, Argentine & Snake River Road Company and completed his route. These roads not only opened western Clear Creek for prospecting and development, but also connected Georgetown with important mining districts over the range to the west. Miners and prospectors then began using Georgetown as a jumping-off point for exploration, contributing to the town's importance.⁴⁵

Mine owners graded feeder trails up to their operations, allowing mule skinnners to lead long strings of draft animals into remote areas. A group of operators built the Magnet Trail up Griffith and Saxon mountains in 1867, grading the Comet Trail to the same area two years later. Miners also beat trails to their properties on Democrat, Republican, and Brown mountains.⁴⁶

No community benefitted more from the widespread development than Georgetown. In three years, the town equaled or surpassed Idaho Springs in size, importance, and sophistication. Georgetown was center to commerce, banking, communications, and culture. Between 1867 and 1869, George Clark & Company established a bank, Lemuel F. Yates opened a law practice, entrepreneurs built saloons and the Georgetown Brewery, and merchants opened several stores. An educated population expressed confidence in the future by starting cultural institutions such as fraternal orders and clubs. A.W. Bernard and J.E. Wharton began printing the *Miner* newspaper while a firm wired a telegraph down the valley. The Methodists, Episcopalians, and Congregationists built churches, and the community funded a school. Community organizers formed a municipal government, formally chartered the town, created police and fire departments, and secured the county seat.⁴⁷

In architecture and overall plan, Georgetown grew according to the typical mining town pattern. A business district became the center of activity and anchored surrounding residential development, all conforming to the townsite's platted grid of lots and blocks. Commercial buildings were a mix of early log or frame construction, large and small, and one to two stories in height. False-fronts were common, and a few entrepreneurs confident in the community added masonry buildings. A nearby forest fire spurred regulations in 1869 necessitating chimney spark arresters, double-wall construction, and buffers between buildings, progressive practices in an early boomtown.⁴⁸ Residences were early log cabins or frame houses, most small and simple. Many were vernacular in appearance, designed for function with no particular architectural style, while some commercial buildings and houses imitated styles then in vogue. In the outskirts, primarily along access corridors, growth evolved organically and the buildings more primitive. Community and cultural institutions had their own buildings, including courthouse, firehouses, jail, and, later, fraternal halls. The drainage's other mining towns followed Georgetown's general development pattern in later years.

⁴⁵ *Colorado Miner* (11/7/67): p4 c2; *Colorado Miner* (10/21/69): p4 c3; Ellis and Ellis, 1983:59; Hollister, 1867:257.

⁴⁶ *Colorado Miner* (6/27/67): p2 c1; *Colorado Miner* (9/9/69): p4 c1.

⁴⁷ Hall, 1895, V.3:320; Harrison, 1964:187; *Tailings, Tracks, & Tommyknockers*, 1986:24; Jessen, 1996:9; Leyendecker, et al., 2005:33, 69, 83.

⁴⁸ Leyendecker, et al., 2005:86.

Between 1870 and 1873, the rush to the Griffith district evolved from prospecting and speculative ventures into a sound mining industry. The trends of capital investment, organized companies, expertise, and engineering fully took hold, and mining experts elsewhere began recognizing Clear Creek drainage. Despite disorder, ill-conceived projects, and failed companies, the progress brought major results. Production of silver soared, and although the principal metal of interest, mining outfits began recovering lead in substantial volumes as well. This was noteworthy because lead fetched a price of less than \$.05 per pound, and at such rates, miners had to extract enormous tonnage of ore for a measurable output.

Apart from the frenetic activity in the district, contemporary production figures clearly reflect the rise of industrial mining. In 1868, companies generated approximately \$142,000 worth of silver, despite the smelting difficulties. The total more than tripled to \$480,000 in 1870, with an additional \$12,000 in lead. These amounts tripled again in only two years to \$1.5 million in silver and \$64,000 in lead.⁴⁹

Several factors on national and local levels contributed to the industry's rise. The national economy recovered from the Civil War, and investors were willing to risk more. They also paid greater attention to silver mining for several reasons. The riches and millionaires produced by the Comstock mines in Nevada created a broad sensation over silver. The excitement at Caribou in Boulder County, then drew the attention of some silver investors to Colorado, and when they surveyed the territory for new ventures, the investors concluded that the Griffith district held similar promise. The Comstock, Caribou, and Griffith districts also reinforced the intrigue of western mining among Eastern investors.

Factors within Clear Creek drainage also stimulated development of the industry. Ore treatment remained fundamental because most grades were unprofitable without local facilities. The early 1870s saw four lasting advances in this arena, based in part on the preceding failures.

The Clear Creek drainage was not alone in its troublesome ore. Gilpin County ran into the same problem as at Idaho Springs and the Griffith district. As complexity increased with depth, conventional milling and smelting became marginally effective, at best. Nathaniel P. Hill, trained in metallurgy and chemistry, solved the problem with a combination roasting and smelting process, building a commercial plant at Black Hawk in 1868. At first, the Black Hawk Smelter accepted ore only from Gilpin County, but Hill increased capacity to take advantage of the unsatisfied regional market by 1870.

Metallurgists in Clear Creek drainage were not, however, acquiescent and continued to find their own solutions to the smelting problem. They understood that they could compete with Hill because the cost of shipping ore by wagon to Black Hawk was exorbitant. In 1870, Stewart, who built the first successful smelter at Georgetown, revised his plant under the Stewart Silver Reducing Company. The facility oxidized ore by roasting, crushed the material to a specific grit, and amalgamating to remove silver. Stewart hired David Brunton as consultant and patented several pieces of specialty equipment for the process. Based in part on this experience, Brunton became a renowned metallurgist, mining engineer, and inventor of the Brunton pocket transit. The Stewart Mill was heralded as the region's first fully effective silver facility, setting a precedent that revolutionized mining.⁵⁰

Other metallurgists followed Stewart's example with their own modifications, most of which were successful. In 1870, for example, Jerome Chaffee, John T. Herrick, Eben Smith, and John Stryker built the Georgetown Silver Works around both smelting and amalgamation. Garrett, Martine & Company sold the idle What Cheer Mill to the Pelican Mining Company in

⁴⁹ Henderson, Charles W. *Professional Paper 138: Mining in Colorado: A History of Discovery, Development, and Production*. Washington, D.C.: U.S. Geological Survey, Government Printing Office, 1926, 109.

⁵⁰ Leyendecker, et al., 2005:138.

1873, which attempted a variation. The plant crushed ore, relying on Bruckner cylinder furnaces for roasting instead of smelting, and then treated the ore with amalgamation.⁵¹

After selling the What Cheer, Martine secured financing from mine owner George Hall and built a niche facility known as an ore sampler. In general, smelting companies preferred to contract with highly productive mining outfits, because they delivered large batches of ore consistent in quality. Small outfits, by contrast, offered limited lots that varied widely in content and purity, requiring testing and constant adjustment to the smelting process. Because of this, smelting companies found the small batches unprofitable and often declined such business entirely. Samplers, on the other hand, relied on the small outfits as a principal customer base and provided several services. Sampling companies assayed ore, determined best smelting methods through testing, and subsequently buying batches for custom treatment. The companies stored lots by type, and upon accumulating enough, adjusted their processes to smelt the ore in a custom run. The G.W. Hall & Company plant, built at Georgetown in 1870, was the first sampler in the drainage.

A year later, H. Augustus and Frank M. Taylor organized the Clear Creek Reduction Company to erect a second sampler, with Brunton as metallurgist. This position became Brunton's first step in a larger sampling business with several plants, known as Taylor & Brunton. The Judd & Crosby Silver Reduction & Mining Company converted its failed smelter into a sampler in 1874, and J.B. Church built the Church Sampler. These and later plants supported numerous small mines, collectively an important segment of the industry.⁵²

George Teal and Edward Eddy made the fourth major contribution to ore treatment, pioneering a process subsequently adopted across the Rocky Mountains. Around 1871, the Terrible Lode Mining Company hired Teal, expert from England, to design and build a mill at Silver Plume. Partnering with Eddy, Teal avoided the smelter idea and instead planned to separate metalliferous material from waste in a process known as concentration. As finished in 1872, the Terrible Mill crushed, screened, and ground ore to a slurry. Using water currents and vibration, a series of mechanical appliances recovered the silver and lead, fluming waste into the nearest drainage. The silver-lead slurry passed through another set of appliances and then dried for handling. Workers sacked the resultant concentrates for shipment to a smelter and final treatment. Mechanical concentration was a relatively new process as of 1872, and few if any metallurgists had yet adapted it to complex silver ore. Teal and Eddy were among the earliest to try, making the Terrible Mill an effective but qualified success. For, although they established a precedent in the greater industry, their exact methods did not translate well to other ore types. In general, concentration was a delicate science that remained in an experimental state, confounding metallurgists and their backers. The reason was that no single milling flow-path, sequence of appliances, or adjustments to machinery were universally applicable. Ore from each mine differed slightly, even when on the same vein, and when machinery and settings achieved separation for one property, they often failed for other operations. When effective, however, concentration was of enormous benefit. Mining companies were able to produce grades of ore otherwise not rich enough to ship directly to a smelter.⁵³

While ore treatment was important to the rise in Clear Creek's production, the mines themselves were equally fundamental. The formal development and engineering projects started several years earlier began paying off. In the Burleigh Tunnel, for example, miners struck a vein threaded with pure silver during 1871. They cut a large mass of ore, loaded it onto a wagon, and

⁵¹ Fossett, 1876:100, 328; Frost, 1880:340; Leyendecker, et al., 2005:169; "Obituary" *EMJ* (7/7/00): 17.

⁵² Fossett, 1880:141, 366; Frost, 1880:342; *Georgetown Courier* (3/24/28): p1 c6; "Obituary" *EMJ* (7/7/00): 17; Wickersheim and LeBaron, 2005:117.

⁵³ Fossett, 1876:102.

brought it to Georgetown with enthusiastic promoter Commodore Stephen Decatur seated on top. Initially, some experts claimed that the veins around Silver Plume pinched out or lost value at depth, dooming the tunnel to failure. Burleigh believed otherwise and continued pushing the tunnel project anyway. The rich strike vindicated him, and at a special public gathering, local mining experts congratulated Burleigh for disproving erroneous assumptions. The event was important, inspiring confidence among investors in similar projects, some of which yielded results. New York City interests organized the Lebanon Mining Company in 1870 to push the Lebanon Tunnel northward into the base of Republican Mountain, striking ore 1,200' in. Frank Marshall had a similar experience with the Marshall Tunnel, which he drove southwest into Leavenworth Mountain to undercut the Colorado Central Vein.⁵⁴

Large companies were not the only contributors to the silver boom, as prospectors and small outfits found and developed yet more veins. Georgetown and Silver Plume were centers to their own localized industries; Silver Plume's in particular was sensational. Most discoveries and development were on the north side of the valley, as Fossett noted in 1876: "Sherman Mountain is east of Brown, and between that and Republican. It is one of the grandest natural depositories of wealth that the world can boast of."⁵⁵ There, prospectors located the Cold Stream, Pay Rock, and Mendota, several of the area's principal producers. Georgetown investor Robert Old bought the Mendota and developed it through the Victoria Tunnel. Success in the Matilda Fletcher on Democrat Mountain in 1870 drew more prospectors who discovered additional veins. Mining outfits enjoyed one rich strike after another on Republican Mountain, where Charles H. Morris and John Dix began developing the Dunkirk via the Herman Silver Mining Company.⁵⁶

The excitement, confusion of claims, lack of precedent regarding mineral rights, and greed fostered a subsidiary industry perhaps more lucrative than mining. Specifically, heated disputes between mine owners supported the new specialty of mining litigation. Colorado mining promoter John Canfield summarized the business:

In the early years it [the region] became the seat of mining litigation; principally over contested rights as to territory of mineral grounds. An imperfect survey, an erroneous or faulty description, and a variety of then minor matters, having no material significance when the mine had no great value, become of supreme importance when the property is proved to be rich, and it is then that an otherwise slight error or discrepancy will put in jeopardy the entire property. A single foot of ground in dispute may involve the right of title to a whole claim, and, as is generally the case, it results in the destruction and ruin of all the parties interested.⁵⁷

The Pelican-Dives case, fought over several rich claims at Silver Plume, established a litigation benchmark. In 1868, Elias S. Streeter and Thomas and John McCuniff discovered the Pelican Lode, staked a claim, but did little with the vein until 1870. In need of capital for development, the partners sold interests in the property in 1872 to Edward Y. Naylor and Jacob Snider, who hired a large crew and began production as the Pelican Mining Company.⁵⁸

In 1869, Thomas Burr took advantage of the Pelican discovery and staked his own claim, the Dives, on the same vein. Burr purposefully abutted his Dives against the Pelican, end to end, because he knew that the vein continued beyond the Pelican boundaries. This was a common tactic that prospectors used to secure productive ground. It remains unknown whether Burr was

⁵⁴ *Colorado Mining Director, 1883*. Denver, CO: The Colorado Mining Directory Co., 1883, 148; Frost, 1880:320; *Georgetown Courier* (3/2/35): p1 c2; Wickersheim and LeBaron, 2005:120.

⁵⁵ Fossett, 1876:348.

⁵⁶ Fossett, 1880:392, 395; Wickersheim and LeBaron, 2005:123, 128.

⁵⁷ Canfield, John G. *Mines and Mining Men of Colorado*. Denver, CO: John G. Canfield, 1893, 105.

⁵⁸ Spurr, J.E. and Garrey, George H. "The Idaho Springs Mining District of Colorado." *Mining Reporter* (1/17/07): 73; Fossett, 1876:345; Leyendecker, et al., 2005:134.

aware, but he staked the Dives over the end of the Pelican, thus the two claims overlapped slightly. Following a series of typical transactions complicating ownership, Burr sold half to speculator William Hamill for development capital. Hamill then sold his half to Georgetown lawyer John McMurdy in 1870 at a profit. McMurdy wanted full possession and bought Burr's half as well. For capital, McMurdy went to New York, established the Perdue Gold & Silver Mining & Ore Reduction Company, transferring half to the company. Hamill secured a position as manager and kept company shares.⁵⁹

Under McMurdy, the Perdue company developed the vein and began heavy production from the overlapping end. Around 1872, the Pelican company suspected that Perdue miners were removing ore from its end of the claim and double-checked the boundaries. How the Pelican company realized the infraction is uncertain. It may be that Perdue miners accidentally broke into Pelican workings, or that Pelican miners heard the blasts of the Perdue crew. In either case, the Pelican party sued Perdue for trespass in 1873, and tried to quash the Perdue company and attach ownership to the ore from the overlap. This was difficult to enforce because the Perdue company was secretive about which portion was in production. High profits from the illicit ore overpowered McMurdy's senses, and he was unwilling to concede to the ore's ownership. Thus, the Perdue miners shipped ore to Georgetown on Sundays to avoid detection.

Both companies secured their own legal experts, who trained themselves in the new field of mining litigation and carried the case upward to the Colorado Supreme Court. In 1874 and 1875, the lawyers secured a series of compromise decisions that at first penalized the Perdue company with a shutdown. The Perdue experts appealed on grounds that the company should be able to continue extracting ore from the rest of the Dives claim. The court then allowed both companies to continue operations, but not within the contested ground.

Impatience with the legal process led to open hostility. Armed Pelican miners invaded the Dives workings through underground passages on grounds that Perdue miners were on Pelican property. The armed men not only seized the overlap, but also portions of the Dives not in question. Both sides then hired guards to watch over the surface facilities and movement of men and freight. The Dives owners appealed to Judge Amherst Stone in Central City to evict the Pelican miners, and he ordered the sheriff to do so by force. When the sheriff approached the Pelican Mine, workers sent him away at gunpoint. His deputies blockaded the mine in an attempt to starve out the Pelican miners, who somehow received enough supplies to stay. The dispute reached a peak when Jack Bishop, previously with William Quantrill's Confederacy guerilla group, grew impatient because he was unable to work his lease in the overlap. Furious, Bishop lashed out at the first mine owner he came across, Jacob Snider. He shot Snider and escaped, and the Pelican gang assumed that the Perdue interests backed Bishop. Tensions ran high until financial matters brought both parties together in 1876. After spending an astounding \$500,000 on legal fees, the two sides divided the contested ground and returned to mining. In the interim, lawyers and judges learned a great deal about how to sue, countersue, interpret law, and argue their positions in mining contests.⁶⁰

As the Pelican-Dives war waged, mining continued elsewhere in the Griffith district, and Georgetown and Silver Plume cemented their community roles. Silver Plume was a working-class mining town with a population of 400 to 500, many families, and a distinct business district that included hotels, mercantiles, and saloons. The town began to absorb its western neighbor

⁵⁹ Leyendecker, et al., 2005:134.

⁶⁰ Fossett, 1876:346; Leyendecker, et al., 2005:134.

Brownville, which received the area's post office in 1871. Four years later, the communities united with the post office transferring to Silver Plume.⁶¹

Georgetown was the center of milling, commerce, and culture, and also a bedroom community for the upper strata. The rise of banking solidified Georgetown's role as the area's financial hub. William Cushman bought George T. Clark's institution in 1872 and reorganized it as the First National Bank of Georgetown. Two years later, A.R. Forbes, Charles R. Fish, and Stewart funded the Miner's National Bank, Stewart contributing smelting proceeds and Fish capital from gold mining at Empire. These and others established the Georgetown Water Works, building a plumbing system both for general consumption and fighting fires. Georgetown was more proactive about fire than most communities and not only erected brick buildings, but also organized several hose companies and stations.⁶²

The expansion of mining during the early 1870s fostered the growth of several other communities in the upper drainage. The Equator, Colorado Central, and Saco mines were too far from Georgetown for a daily commute by foot, so workers lived in a collection of residences on Leavenworth Mountain. Silver Dale, a haphazard community of seventy-five residences, lacked businesses or a post office, typical for industrial mining camps. Other miners lived near their points of work in log or frame cabins and boardinghouses usually built by a company. Historian Fossett noted the conditions in the western reaches of the Clear Creek drainage:

The miners live in houses that are fastened down into the cliffs, not coming down except when going to Georgetown, ten miles away. In winter, when snows are constant, and the storm king, whose home is in these solitary peaks, holds high carnival around the mountain's brow, days pass when it is impossible to see across the gulch. Communication is then shut off from the rest of the world; and in fact the miners lay in their winter's supplies in the autumn months.⁶³

Silver Mining in the Western Drainage, 1875–1893

The period spanning 1875 to 1893 saw two important trends in Clear Creek drainage. In the western extent, silver mining exhibited characteristics of maturation. Prospecting changed accordingly from an individual to industrial endeavor, and although traditional surface exploration continued, it declined because most principal veins had been found. Instead, companies pursued exploration campaigns underground to quantify known veins and hopefully blunder into concealed formations. Ore production and mine development began changing as well. Although there were plenty of small outfits, large companies backed by powerful investors dominated. The Griffith and Argentine mining districts became a curious mix of heavy industry, social stratification, and a rugged culture adapted to a high-altitude environment.

The other trend was an awakening of gold mining in the eastern drainage after long dormancy. Mining in the east quickly went through the same industrialization stages as the west. By the end of the time period, the east featured some of the deepest and most advanced mines, as well as an array of efficient mills, but the region never approached the west in terms of production. For comparison, the west generated seventy-five percent more income than the east, where gold mining was a significant and yet separate industry.

The advent of the railroad was a third trend impacting the entire drainage. When William A.H. Loveland and Henry Teller organized the Colorado Central Railroad, they planned a line from Golden through Idaho Springs to Georgetown. Financial setbacks stalled the project several

⁶¹ Abbott, et al., 2007:383; Bauer, et al., 1990:24, 132; Leyendecker, et al., 2005:87.

⁶² Frost, 1880:291; *Georgetown Courier* (4/14/28): p4 c2; Jessen, 1996:43; Leyendecker, et al., 2005:92.

⁶³ Fossett, 1876:355.

times, and when the Colorado Central finally began pushing up Clear Creek canyon, the Panic of 1873 stopped progress at the base of Floyd Hill. The Colorado Central thus established a temporary railhead at the far eastern end of the valley, and although still far from Idaho Springs, it immediately lowered transportation costs. Previously, wagons imported freight over Floyd Hill or from Central City via the northern mountains, and also carried ore to smelters in Black Hawk and Central City. With the Colorado Central railhead, wagons merely had to travel as far as the valley's eastern end. The net result was an enormous reduction in rates, which translated into lower operating costs for mining companies. The lower costs, in turn, allowed them to pursue previously unprofitable grades of ore and thus increase overall production. When the Colorado Central finally finished the line to Georgetown in 1877, and the Georgetown, Breckenridge & Leadville Railroad continued up to Silver Plume in 1884, they furthered these trends and improved the quality of life for residents. These railroads are discussed in detail in the section on transportation.

As companies developed more mines than before, production increased by around twenty-five percent from approximately \$1.5 million in 1872 to \$2.1 million in 1874. The companies not only continued shipping to the Black Hawk Smelter, but now found it affordable to send specialty batches of complex ore by rail to facilities as far away as Michigan, Missouri, and even Pennsylvania. Overall, the development of mining, local ore treatment, and community growth continued through the mid-1870s, sped from formative to maturation by the railroad.⁶⁴

The long-awaited success of local ore treatment worked synergistically with the railroad, further propelling the industry. Whereas the Black Hawk Smelter was too efficient to compete against directly, local metallurgists continued to build niche facilities, employing the lessons learned from their failures. Stewart rebuilt his roasting and amalgamation plant in 1875 after it burned. At the same time, Chicago investor J.V. Farwell bought the failed Judd & Crosby Smelter and refitted it with a modification of Stewart's process. Now known as the Farwell Mill, the facility relied on Bruckner cylindrical furnaces to roast the ore and rotating amalgamation pans to extract the silver.⁶⁵

Investors backed local metallurgists in the construction of four new ore samplers during the mid-1870s. W.W. Rose funded the Silver Queen Reduction Works. William Bennett, who ran the Wilson & Cass Smelter in 1869, organized the Pennsylvania Lead Company. Jonathan W. Cree and Patrick McCann established the firm of Cree & McCann. Cree previously managed the Bohemia Smelting Company while McCann ran the International Smelter at Argentine from 1868 to 1872, followed by the Judd & Crosby plant before it failed. In 1876, James F. Mathews and Charles H. Morris partnered as Mathews, Morris & Company and built the Rocky Mountain Mill. Morris, son of a mining investor, brought both experience and capital. He bought a mill at Dumont in 1869, struggled for a year with troublesome ore, before selling the plant as a failure. The Spanish Bar Mining Company then hired Morris as superintendent of its mill, and he resigned in disgrace after mismanaging the facility. Afterward, Morris followed his father's example and turned to mining investment, in which he was highly successful. He purchased shares of the Pay Rock Mine and organized the Herman Silver Mining Company to develop the Dunkirk, both above Silver Plume, applying profits to build the Rocky Mountain Mill. The sampler was known as the Rocky Mountain Crushing & Sampling Works by the late 1870s. G.W. Hall & Company was still in business, and Taylor and Brunton expanded their sampler as the Clear Creek Ore Dressing & Reducing Company.⁶⁶

⁶⁴ Fossett, 1880:360; Henderson, 1926:109.

⁶⁵ Fossett, 1876:322; Frost, 1880:342.

⁶⁶ Fossett, 1876:330; Fossett, 1880:366; Leyendecker, et al., 2005:138; Wickersheim and LeBaron, 2005:90, 148, 149.

Curiously, nearly all the new samplers and mills went up at Georgetown, even though most ore came from Silver Plume. Not until the mid-1870s did several metallurgists build mills at the source. After their success with the Terrible Mill in Georgetown in 1875, Teal & Eddy established their own concentration mill and sampler in Silver Plume. Franklin Ballou then followed with the Silver Plume Mill.⁶⁷

Silver Plume was the most productive community in the western drainage, and its mining industry matured during the mid-1870s, earlier than elsewhere. Consolidation among separate outfits typified maturation, as some realized cooperation was in their best interest. In 1875, William A. Clark, Georgetown banker William H. Cushman, and others organized the East Roe Silver Mining Company to work on Brown Mountain. They came into heated conflict with the owners of the Hercules property and with Heneage M. Griffin operating the adjoining Seven-Thirty Mine. Instead of warring, the three parties consolidated operations as the Hercules & Seven-Thirty Consolidated Silver Mining Company. The Pay Rock owners and their neighbors formed the Pay Rock Consolidated Mining Company and developed their vein through the Pay Rock Tunnel. In 1876, William Hamill and Jerome Chaffee consolidated mines and operated them jointly through the Union and Silver Ore tunnels. The operation was among the earliest in the drainage to use steam drills in underground development. These three mines were among Silver Plume's most profitable producers.⁶⁸

Through consolidation, mining outfits increased capital reserves, saved operating costs, and improved overall efficiency. Complexity of infrastructure and stratification of workforce were byproducts of combined operations. When companies merged, they added machinery and surface facilities, dividing labor into specialty positions. Miners employed by small outfits conducted a wide variety of tasks such as drilling, blasting, timbering, tramming ore, and minor engineering. At large companies, in contrast, workers spent shifts on relatively narrow sets of tasks, much like factory labor. Further, companies organized workforces into hierarchies of unskilled and skilled positions, foremen, superintendents, managers and engineers. Such stratification allowed workers to become experts in their fields, but provided little room for upward mobility.

Georgetown enjoyed a small wave of discoveries and development on mountains flanking the valley. In 1874, miners blasted open an outstanding ore body in the Fred Rogers Mine on Democrat Mountain, intensifying interest in the slopes north of town. Democrat still offered opportunity for surface prospecting, and individuals quickly found the Silver Cloud and Silver Gance lodes. On neighboring Columbia Mountain, the Hukill Gold & Silver Mining Company, which also ran the Hukill Mine in the eastern drainage, encountered high-grade ore in the Nuckolls Mine in 1876. Leavenworth Mountain featured the earliest and most productive mines, including the Marshall, Bruce, Thompson, and Robinson tunnels, which developed separate sections of the Colorado Central Vein. At the end of 1876, lessees on a different property blundered into a vein they named the S.J. Tilden, one of the richest yet discovered. This created considerable excitement, spurring underground exploration from within other mines on the mountain. Several outfits demonstrated that Griffith Mountain held potential. In 1876, Ohio investors established the Ohio Comet Silver Mining Company and began the Comet Tunnel, and the Magnet and Jerome Chaffee's Anglo Saxon Mine also resumed production.⁶⁹

The late 1870s and early 1880s represented a high point in western Clear Creek drainage. A larger number of substantial operations generated more money, and on a sustained basis, than

⁶⁷ Fossett, 1876:329, 366; Frost, 1880:343.

⁶⁸ *Colorado Mining Directory*, 1883:160; Fossett, 1876:339, 349; Frost, 1880:310, 312; Wickersheim and LeBaron, 2005:90, 97, 111, 129.

⁶⁹ *Colorado Mining Directory*, 1883:159; Fossett, 1876:359-366, 402; Frost, 1880:318; Wickersheim and LeBaron, 2005:138.

any time before or after. Small outfits developed dozens of shallow mines as well, significant on a collective basis. Ore production remained a relatively constant \$2 million per annum primarily in silver and secondarily in lead and copper. And yet, the boom would have been greater were it not for Leadville, which siphoned off some interest.

Two synergistic factors contributed to the unrivaled period of prosperity. One had to do with the value of silver. In 1878, the federal government passed the Bland-Allison Act, in essence a massive subsidy for silver mining. Initially, the government declared that the treasury would recognize a gold standard to the exclusion of silver. Concerned over the impact to silver mining, western politicians drafted the Bland-Allison Act, which reinstated partial monetization of silver and required the government to purchase at an average of \$1.20 per ounce. Previously, silver fetched \$1.15 per ounce, but the gold standard and slight fluctuations in price destabilized the market. The increase in value, coupled with the stability imparted by the Act, instilled industry confidence.⁷⁰

The other factor chuffed into Georgetown in 1877. The Colorado Central Railroad finished its Clear Creek line and not only reduced freight rates, but also provided a direct all-season link with smelters and commercial centers. The reduced freight rates lowered operating costs for mining companies, allowing them to haul in more machinery and erect larger structures. As a result, companies again found previously uneconomical grades of ore now profitable to mine. Residents also enjoyed a greater variety of goods at lower costs, and dignitaries in turn were likely to invest when they could personally visit the region.

Georgetown in particular welcomed the potential investors, who could find quality lodging in the American, Ennis, and Yates houses, or in the Centennial and Star hotels. Several restaurants provided sophisticated menus, and the business district featured fine saloons. Most wealthy visitors stayed at the Barton House and sought fine dining in Charles Dupuy's French restaurant, which evolved into the famed Hotel de Paris (see Illustration A 1.2.13). Architecture became more sophisticated and substantial, exemplifying styles including Greek Revival, Second Empire, and Italianate. Tourist and industry promoters offered glowing accounts of Georgetown, such as Fossett:

Its appearance and surroundings are superior to those of any other mountain town. Around it are lofty mountains, ribbed with silver veins, which rise abruptly to heights of from twelve hundred to twenty-five hundred feet above the almost level valley in which the town is built. Here are silver reduction works, ore concentrating mills, and sampling and ore buying establishments, all of which do a large business. The mining operations of the district are very extensive, resulting in an annual export of silver bullion and ore to the value of over two million per annum.⁷¹

Mining around Georgetown finally began passing through the same stages of maturity as Silver Plume. Leavenworth, celebrated mountain of silver, was subject to more deep development, advanced engineering projects, consolidation, and litigation. Jeremiah Kirtley and E. S. Weaver held claims on the Kirtley Lode but lacked capital for development at depth. Charles Martine, involved with the Hall Sampler, saw an opportunity to acquire an interest in the operation in exchange for funding. The partners organized the Kirtley Tunnel Mining Company in 1877 and began the Kirtley Tunnel, using rockdrills to hasten progress. The company, among the earliest at Georgetown to use drills, struck the Kirtley Lode the next year. The vein proved to be a bonanza, and over the course of several years, the company demonstrated that it was the trunk of a larger system within the mountain. Various claim owners originally thought that the

⁷⁰ *Report of the Director of the Mint*, Washington, D.C.: Government Printing Office, 1894, 20; Saxon, Glenn O. *Colorado and Its Mining Industry (1859-1959)*. Yale University, 1959, 7, 8, 14, 16; King, 1977:92.

⁷¹ Fossett, 1880:95.

Argentine, Gates, O.K., Stranger, and Tilden veins were distinct, but were instead branches of the master Kirtley Lode. Needless to say, the Kirtley Tunnel became one of Georgetown's best producers.⁷²

Chicago investors had a similar experience with the Equator Lode. They purchased the poorly developed property on Leavenworth in 1878, organized the Equator Mining & Smelting Company, and prepared for heavy production. The company installed a system for rockdrills, pushed the Equator Tunnel 1,100', and when miners reached the vein, made connections with a shaft sunk from above. Miners sent ore to the Equator Mill in Georgetown for concentration, and the company yielded \$1.2 million by 1883.⁷³

Frank Marshall worked the Colorado Central Lode beginning in 1868, and William P. Lynn found an extension of the vein four years later, claiming it as the Ocean Wave. Only by tracing the formation across the mountain did Lynn realize the Ocean Wave's origin. He felt that legal criteria gave him mineral rights to the rest of the Colorado Central Lode and brought suit against Marshall for trespass. Although Marshall predated Lynn, he was uncertain about his rights and negotiated. Instead of pouring money into the pockets of lawyers, the two parties merged their holdings as the Colorado Central Consolidated Mining Company in 1879, linking underground workings. The mine then became one of the largest near Georgetown with 4,000' of development drifts along the vein.⁷⁴

The wave of prospecting and shallow development on Democrat Mountain paid off during the late 1870s, as well. Local entrepreneurs acquired lesser mines while distant investors bought the best properties. Georgetown doctor William Burr and Duncan McArthur organized the Lincoln Mining Company and worked the Fred Rogers, a shallow but sound producer. Cincinnati investors operated the W.B. Astor Mine while New York interests organized the Polar Star Silver Mining Company, both operations ranking among the heaviest producers on Democrat. Prospectors found the Little Emma in 1877 and sold to James F. Mathews of Denver, who he secured Cincinnati investors. They established the Good Luck Mining & Milling Company in 1880 and realized \$125,000 in only three years. Experienced mining engineer Ernest Le Neve Foster developed several prospects into sound producers. The Fletcher Gold & Silver Mining Company secured him as superintendent for the Matilda Fletcher in 1878, and he also operated the Magnet Mine on Saxon Mountain for the Magnet Mining Company.⁷⁵

Mining at Silver Plume was farther along (see A 1.2.11 and A 1.2.12). During the first years, miners extracted ore from the upper sections of veins because it was rich, easy to treat, and accessible. But by the late 1870s, miners exhausted shallow ore and pursued deeper reaches through longer tunnels and deeper shafts, requiring more engineering, machinery, and larger workforces than before. The associated need for capital solidified the trend toward consolidation and large-scale operations. As at Georgetown, local interests owned the small mines while distant investors backed large companies. Sherman, Brown, and Republican mountains all possessed enough ore to sustain these operations.

Mining outfits perforated Republican Mountain with dozens of tunnels, and six substantial companies sent down tons of ore daily. Georgetown banker Charles Fish established Charles R. Fish & Company during the early 1870s, acquiring the Corry City on Sherman Mountain. By decade's end, investors bought the Corry City, as well as mines on Republican Mountain, planning to undercut the lot with one of Silver Plume's most ambitious tunnels. They

⁷² *Colorado Mining Directory*, 1883:147; Fossett, 1880:362; Frost, 1880:321; Spurr and Garrey, 1908:265; Wickersheim and LeBaron, 2005:117.

⁷³ *Colorado Mining Directory*, 1883:133, 148; Frost, 1880:321; Wickersheim and LeBaron, 2005:101.

⁷⁴ Fossett, 1876:358; Frost, 1880:320; Spurr and Garrey, 1908:245.

⁷⁵ *Colorado Mining Directory*, 1883:146, 162, 173, 177; Fossett, 1880:388; Wickersheim and LeBaron, 2005:121, 123, 131, 134, 145.

formed the Colorado Diamond Tunnel Silver Mining Company, hired John Fish as superintendent, and pushed the Diamond Tunnel 2,100' through Republican and into Sherman. The Lebanon Mining Company followed a similar strategy and advanced from the base of Republican 1,200' to the Elija Hise vein. Promoters of these and other projects enticed investors with visions of hidden veins awaiting discovery. Although most tunnels failed to find such veins, the Lebanon was an exception and breached eight. The company was then confident enough to build its own concentration mill.⁷⁶

Local experts backed by distant investors ran four more heavy producers on Republican Mountain. In 1877, concentration pioneer George Teal and Ernest Le Neve Foster joined as the consulting firm of Teal, Foster & Company. Their relationship transgressed business in 1875 when Foster married Teal's daughter, Charlotte. Because the partners were from England and had outstanding reputations, British investors naturally selected the firm to oversee their companies in the Griffith district. Teal and Foster did not disappoint, rendering the Silver Plume Mining Company and Snow Drift Silver Mining & Reduction Company highly profitable. Charles Morris' Herman Mining Company continued to operate the Dunkirk, while his Pay Rock Consolidated worked the Pay Rock. The latter mine, second only to the Pelican-Dives, yielded \$450,000 and purchased the Silver Plume Mill to treat its ore.⁷⁷

Brown Mountain was not quite as rich as Republican, but home to several major producers nonetheless. Like some mines on Republican, local interests ran operations with outside funding. William Clark's Hercules & Seven-Thirty Consolidated Silver Mining Company continued producing ore through the Hercules Tunnel (see Illustration A 1.2.12). The Baltimore Tunnel Mining Company pushed 750' into the mountain before running out of money. The Colorado Territory National Silver Mining Company took over, hiring Jacob Fillius as superintendent. Fillius came to Georgetown as a school teacher, becoming involved with mining through a few fortunate investments. The Baltimore was among Fillius' first charges, and it provided him an economic foundation to rise as an important local mine owner and railroad builder.⁷⁸

The Terrible Mine, one of Silver Plume's crown jewels, was subject to legal negotiations and extortions typical of the boom. British investors bought the claim in 1869, organizing the Terrible Lode Mining Company to develop it. Miners quickly demonstrated that the vein was rich, drawing the attention of local speculator William Hamill. He then purchased the adjacent Gun Boat, Silver Ore, and Tycoon claims, either on the assumption that their value would rise because of proximity to the Terrible or as the basis for a mineral rights lawsuit against the British company. Hamill chose the latter course during the early 1870s. Hamill's group of claims predated the Terrible, so he asserted he held the mineral rights to the entire vein and threatened to sue if the Terrible company did not cease or pay him a handsome price. The company, however, had leverage. Its lawyers realized that Hamill could not prove his property was on the vein because its workings were too shallow. Hamill lacked the funds for necessary development and watched the Terrible Mine disgorge tons of silver ore he insisted was his. When Hamill was appointed manager of the Dives in 1874, his salary allowed him to finally sink workings on the claims. After a year, Hamill had positive proof that his claims and the Terrible were on the same formation and reinstated his lawsuit. The Terrible company underestimated Hamill's position.

⁷⁶ *Colorado Mining Directory*, 1883:131; Frost, 1880:312-314; *Report of the Director of the Mint*, 1883:428; Wickersheim and LeBaron, 2005:94, 120, 149.

⁷⁷ Fossett, 1880:392; Wickersheim and LeBaron, 2005:97, 129, 139.

⁷⁸ *Colorado Mining Directory*, 1883:122; Fossett, 1880:396; Frost, 1880:310; Wickersheim and LeBaron, 2005:82, 137.

Because Hamill's claims predated the Terrible, the court awarded him rights to the vein, and the case set legal precedent for similar conflicts elsewhere.⁷⁹

The net results were wealth for Hamill and another large consolidation in 1877. Hamill's price was one-third interest in the company and the position of manager. He was tough on labor, difficult to work with, and reported to the company only as he pleased. But the company tolerated Hamill because he made the Terrible one of Silver Plume's best producers. The investors reorganized the assets as the Colorado United Mining Company to include Hamill and his claims. Afterward, the Terrible Mill went by the name of the Colorado United.⁸⁰

Two more large consolidations came out of heated lawsuits. In 1877, feuding owners of the Pelican and Dives mines, discussed above, merged their extensive operations as the United Pelican & Dives Mining Company. Colorado's mining elite, including Bela M. Hughes and Eli S. Streeter, came with the Pelican and fattened their portfolios. Jacob Fillius and Charles Fish ran the profitable Cold Stream on Sherman Mountain and sued the adjacent Phoenix over mineral rights. Instead of spending money on lawyers, the parties merged as the Cold Stream Consolidated Mining Company in 1878. Their reward was \$500,000 in silver by 1883.⁸¹

The Argentine Mining District underwent the same process of maturation as Georgetown and Silver Plume. But because the district was smaller, more remote, not as rich, and discovered earlier, much of the district was already in decline. Prospectors had moved on, miners exhausted shallow ore formations, and most operations failed. Proven mines continued attracting investors, however, and local interests worked the small properties while large companies acquired the substantial operations. The Baker and Stevens mines were two of the most important in the district, located in the northern reaches near Clear Creek. The Stevens Mining Company began in 1874, investing in extensive surface facilities including a long, inclined tramway from the main tunnel down to a loading station. The mine, however, was very difficult to work because of the alpine environment, and investors grew weary and decided to sell. Heneage Griffin, heavily involved with the Hercules at Silver Plume, contacted fellow British investors who organized the Northwest Stevens Mining Company in 1878, appointing Griffin as agent. Through careful management, Griffin systematically developed the mine for long-term production, which kept him busy for twenty years.⁸²

R.B. Weiser leased the Baker Mine in 1879, installed new machinery, and did well for several years. His improvements and record of production attracted other British investors, who bought the mine and hamlet of Bakerville under the British Queen Mining Company in 1882. In continuing production, they increased yield beyond \$500,000. The company also may have been as interested in Bakerville as it was in the mine because the thriving settlement held great promise. Bakerville was the western-most outpost in Clear Creek drainage, one of its most important lumber centers, and on a route projected by the Georgetown, Breckenridge & Leadville Railroad. Union Pacific officials chartered the railroad in 1882 to finish a link they planned between Georgetown and Dillon in Summit County. The route began at the Colorado Central railhead in Georgetown, wound up the main fork to Silver Plume, continued through Bakerville toward Loveland Pass, and under the Continental Divide through a tunnel. From there, the route descended the Snake River to Dillon. The British Queen company stood to benefit because not only would Bakerville initially serve as a construction camp, but also as an

⁷⁹ Fossett, 1876:337; "Latest Mining News" *Rocky Mountain Mining Review* (4/2/85): 1.

⁸⁰ *Colorado Mining Directory*, 1883:127; Wickersheim and LeBaron, 2005:91.

⁸¹ *Colorado Mining Directory*, 1883:126; Frost, 1880:310, 312; Wickersheim and LeBaron, 2005:90, 143.

⁸² *Colorado Mining Directory*, 1883:158; Ellis and Ellis, 1983:98.

important coal and lumber station once the line was in operation. Associated property values were likely to rise.⁸³

Workers began grading the line almost at once, but the narrow canyon and steep ascent between Georgetown and Silver Plume slowed progress. By 1883, track gangs finished the bed, spiked rails to Silver Plume, and pushed onward to Bakerville. Although most of the track was ready, errors in building the High Bridge over Devil's Gate caused further delays in opening the line to traffic. In the interim, railroad officials came to the same conclusion as the British Queen company about the value of a station on the main fork. But instead of choosing Bakerville, they platted Graymont nearby in 1882 to secure the sawmill and mining trade for themselves. Several residents built cabins, the Fox and Hounds tavern opened, J.D. Jennings ran the Jennings Hotel, while Griffin erected ore bins for the Stevens Mine. The railroad parked a box car as a station and secured a post office. Despite its sawmills, Bakerville failed to grow as expected because of Graymont. Adding insult to injury for the British Queen company, Union Pacific cancelled its plans to finish the route over the Divide, and Graymont became the end of the line. In 1884, steelworkers rectified the problems with the High Bridge, and the railroad began traffic to Silver Plume and Graymont.⁸⁴

The Georgetown, Breckenridge & Leadville Railroad was a grand and cleverly engineered extension of the Colorado Central, impacting Silver Plume. Direct rail service eliminated the need to transport freight by wagon up from and ore down to the Colorado Central railhead at Georgetown. This reduced operating costs for the mining companies, allowing them to pursue lower grades of ore. The net effect was, however, not the significant increase in production usually attributable to railroads. During the mid-1880s, the entire drainage maintained a net of \$1.5 million per year, which decreased to \$1.3 million by 1887. Two compounded factors offset the benefits of the railroad, beginning a long-term pattern that dogged the western drainage for decades.

One was the downside of fifteen years of continuous production. Miners not only exhausted the richest ore in the upper reaches of the principal veins, but also the lower grades of material. The mountains still contained great reserves of ore, but the material was deep, complex, and not yet fully developed for extraction. Necessary work at depth in turn required greater infrastructure. The other factor was a synergy of forces that not only caused the value of silver to slip, but also made investors wary of its mining. In particular, opponents of the silver standard shifted Treasury policy in favor of paper currency and loudly opposed the free coinage of silver. In 1885, the value of silver decreased from \$1.12 per ounce to \$1.06 and continued downward until bottoming at \$.94 by 1888. The watershed year, however, was 1886, when President Grover Cleveland's anti-silver stance became well-known and silver reached \$1.00 per ounce. The prices for industrial metals fell in parallel, and lead decreased by a penny to \$.04 per pound.⁸⁵

The mining industry contracted slightly, and while Silver Plume remained stable due to the railroad, Georgetown felt the effects more acutely. Real estate values declined, less capital flowed into town, and some mining experts left. The business district remained vibrant, but the luxury hotels and restaurants were not as busy as before. Charles Dupuy's Hotel de Paris was an exception, reaching peak popularity during the late 1880s. Originally Adolphe Francois Gerard, Dupuy was a cultured Frenchman who joined the army in 1868 stationed in Cheyenne. He considered himself above the chain of command, promptly deserted, and changed his name to Dupuy. Hiding in Denver a short time, he went to Georgetown and worked in the Kennedy Mine

⁸³ *Colorado Mining Directory*, 1883:121; Ellis and Ellis, 1983:67.

⁸⁴ Ellis and Ellis, 1983:192, 215, 218.

⁸⁵ Brown, Robert L. *An Empire of Silver*. Denver, CO: Sundance Publications, 1984, 191; "Mining News" *EMJ* 8/14/86 p119; *Report of the Director of the Mint*, 1894:20; Saxon, 1959:7-9, 14-17.

until 1873, when he was severely injured by a delayed dynamite charge. Dupuy found a job in the Delmonico Bakery and eventually bought the business, expanding it into a restaurant and boardinghouse. In 1882, he expanded again as the Hotel de Paris, which hosted a number of dignitaries. Dupuy was cantankerous but well known for his outstanding cuisine and cellar of imported wines. He often refused service to people he thought inferior and closed on busy holidays, but despite such practices, the Hotel de Paris thrived.⁸⁶

Ore samplers and concentration mills continued in Georgetown during the late 1880s, but treated less ore. Most small mines were idle because high-grade ore was exhausted, and the days when investors freely speculated were over. The large companies, however, had the resources to develop their deep reserves and therefore generated enough payrock to keep the mills busy.

The Colorado Central Consolidated Mining Company was one such operation, spending a small fortune preparing the lower extent of the Colorado Central Vein for production. Manager George Hall, who owned an interest since 1868, commissioned the Hall Tunnel in 1887 as the deepest haulageway yet driven to the vein. Miners started the tunnel into the base of Leavenworth Mountain, well below the Marshall and Ocean Wave tunnels, and planned to work the vein from the bottom up once they reached it. The project was a considerable undertaking because the miners had to penetrate 4,500' of hard rock. As hoped, the tunnel intersected several profitable veins after only 1,500', which offset some cost. Several years passed before the tunnel was finished.⁸⁷

Even though Georgetown was static in some ways during the late 1880s, it remained a highly progressive and sophisticated community. Georgetown was a center for technological development since its beginning, when the Griffiths built what was arguably Colorado's first aerial tramway. The town continued this tradition when it hosted one of the earliest electrical systems in the Rocky Mountains. In 1886, M.T. Morrell built a small hydropower generation plant and began limited service for electric lighting. Charles Fish owned the local gas company and held tight the contract for municipal lighting, which locked up Morrell's most important customer base. Although Morrell struggled and then quit in 1888, he pioneered an important model that other electric entrepreneurs shortly emulated.⁸⁸

At Silver Plume, many small mines also closed, but the large operations offset their absence. Companies employed an army of miners who supported a substantial business district and cultural institutions such as churches, fraternal orders, and theater. A total of three grocers, several butchers, and two slaughterhouses provided food. Miners could drink in Silver Plume's nine saloons or buy beer directly from a brewery. They bought finery from two clothing stores and three shoe stores, also supporting three laundries. A drug store, several barbers, and a doctor provided health and hygiene, and residents had watches repaired in a jewelry shop. Five hotels received guests who found entertainment in an opera house. The town also featured a water system, school, and several newspapers.⁸⁹

Although most mining companies maintained regular production, the poor silver climate caused anxiety. Investors and directors instituted policies typical of industry under duress and en route toward decline. In one trend, mine owners and investors cashed out of their holdings, creating opportunities for several large buyouts and consolidations. The Colorado United Mining Company felt that the Terrible had little left to offer after yielding enormous profits and sold the

⁸⁶ Colorado Historical Society. *Hotel de Paris and Louis Dupuy in Georgetown, Colorado*. Boulder, CO: Johnson Publishing Company, 1954, 4; Jessen, 1996:53; Leyendecker, et al., 2005:88, 186.

⁸⁷ "General Mining News" *Mining Industry* (8/17/88): 75; "General Mining News" *Mining Industry* (8/2/89): 55; "General Mining News" *Mining Industry* (8/23/89): 83.

⁸⁸ Leyendecker, et al., 2005:250.

⁸⁹ Griswold, P.R., Kindig, Richard H., and Trombly, Cynthia. *Georgetown and the Loop*. Denver, CO: Rocky Mountain Railroad Club, 1988, 145; *Tailings, Tracks, & Tommyknockers*, 1986:35.

mine to Colorado Silver Mines, Ltd. in 1885. John W. Brown brokered a major deal in which Eastern investors purchased the Lebanon Mining Company, Clear Creek Mining & Improvement Company, and a spread of claims on Republican Mountain. Brown was adept at such negotiations and had experience with a similar venture near Idaho Springs as well as several companies on Republican. British investor J.H. Platt backed the most sensational consolidation of the time. In 1888, he organized the Florence Mining & Milling Company and bought the Pay Rock Consolidated and Silver Plume Mining companies as the foundation for an advanced ore production and milling operation. Both were among Silver Plume's most celebrated producers and cost a fortune. Platt invested yet more money on the Ashby Tunnel, also known as the Florence, to undercut the vein system at levels deeper than the existing Pay Rock Tunnel. The Ashby, 1,200' long, served as the working platform for ore production, requiring a well-equipped surface plant. The company inherited the Silver Plume Mill from the Pay Rock company, renamed it the Florence, and refitted the facility not only to treat its own ore, but also custom material from other mines. In so doing, the company provided a needed service while recovering some of its construction costs. Now saddled with a massive debt load, the company had no choice but to hire a large crew and maximize production.⁹⁰

In another trend, companies focused on the massive waste rock dumps fanning out from the mouths of every tunnel and shaft. In some cases, these dumps contained low-grade ore that miners initially rejected as unprofitable. By the late 1880s, concentration methods rendered such material profitable, and all a company need do was dispatch a crew to sort through the dump and recover payrock. In the Griffith district, the practice began during the late 1880s and became an important secondary source of ore in later decades.

Some owners leased all or portions of their mines as another response to an uncertain business climate. A lease was an arrangement where a party of miners paid the owner a fee for the right, by legal contract, to work a property. The fee varied, ranging from a percentage of the gross income, to a flat rate, to a combination of the two. A fee of twenty percent was common, although it varied from as low as ten to as high as sixty percent, based on the quantity and quality of ore. By leasing out a mine, the owner realized income while investing little effort and shifting financial risks and operating costs over to the lessee. Lessees stood to benefit because they had the potential to make more money than company wages at least or strike bonanza ore at best. Leasing, however, had its pitfalls. The potential for dishonesty among all parties fostered a sense of insecurity. Some lessees tried to hide production, and on more than one occasion the owner attempted to cancel a lease after lessees made a rich strike. Because lessees had to pay their own operating costs, they had a tendency to ignore the infrastructure necessary for a mine's long-term well-being or worker safety. In their haste, some lessees even damaged underground workings through poor practices, leaving them in a state that required costly improvements. In some cases, the mine owner or company maintained the mine and operated the surface plant while leasing blocks of ground or sections of workings to individual miners, who tried to extract ore as fast as they could.⁹¹

In general, widespread adoption of the system was a signal of an industry in distress as well as a lack of investor confidence in individual mines. Silver Plume saw a wave of leases during the late 1880s, around ten years before the practice became common elsewhere. Jacob Fillius leased a section of the Pay Rock prior to selling the mine to Platt in 1888, and Platt subsequently issued more agreements. Gabriel Bartolomea leased the Farwell Mill at

⁹⁰ "General Mining News" *Mining Industry* (5/4/88): 12; "General Mining News" *Mining Industry* (6/8/88): 13; "General Mining News" *Mining Industry* (6/29/88): 8; "General Mining News" *Mining Industry* (7/19/89): 35; "Latest Mining News" *RMMR* (1/15/85): 10; "Prominent Mines of Clear Creek County" *Mining Industry* (1/20/88): 9.

⁹¹ Brown, 1979:101, 114; "Editorial Correspondence" *EMJ* (4/20/12): 807.

Georgetown and refitted it to treat ore from a block of ground he also leased in the Burleigh Tunnel. More Italians leased the Seven-Thirty and Silver Cloud mines, producing heavily.⁹²

Unlike Georgetown and Silver Plume, the Argentine district fell into a deep slump due to the poor climate of the late 1880s. Most mines closed, leaving only a handful of operations on the deepest veins. The Stevens was among these, as the Northwest Stevens Mining Company found the mine not as profitable as the British had hoped. Heneage Griffin, however, retained confidence in his ability to sustain long-term production and bought the property in 1885. He continued his wise strategy, so often ignored by inexperienced mine owners, of reinvesting some income in deep development and infrastructure. During the late 1880s, Griffin began the Level 14 Tunnel from Stevens Creek to undercut the vein and work it from the bottom up. Miners increased production to 100 tons of payrock per month, and Griffin erected new ore bins at Graymont to store the material. The Stevens was more attractive than ever, and Griffin had an easy time selling it to yet another party of British investors, who organized the Mount McClellan Mining Company in 1890. Stevens remained manager.⁹³

Despite wariness among owners and investors, the industry passed into the early 1890s in a productive condition. In 1890, around 1,925 people lived in Georgetown, 1,250 in Silver Plume, and more scattered at surrounding mines. A total of 2,000 men worked in forty-five principal mines and six mills. Such statistics suggest that approximately one-half of the population consisted of able-bodied workers, many of whom were unmarried miners.⁹⁴

During 1890, the federal government instituted its first new policy regarding silver since 1878, boosting mining in the western drainage. During the late 1880s, Western legislators clamored for a return to a pro-silver policy to bolster sagging mining industries in their states, as well as their own personal stock portfolios. Well-organized, they succeeded in 1890 with the Sherman Silver Purchase Act, which required the government to buy 54 million ounces silver per year at \$1.05 per ounce. These figures fostered demand and pricing capable of resuscitating silver mining, which created jobs, revitalized regional economies, and, of course, improved the popularity of legislators among their constituents. In most of Colorado's silver districts, prospectors returned to mountainsides in search of new veins, speculation supported small ventures, and large companies increased production. The Griffith district, however, missed the statewide trend. In 1889, the industry generated \$1.7 million in silver and \$209,000 worth of lead, which increased only slightly to \$1.9 million for silver and \$541,000 in lead the following year. By 1891, when the Sherman Act was in full force, the figures even regressed.⁹⁵

Why did the Griffith district fail to respond to the positive silver climate? Its mountains simply lacked the ore reserves to support a large increase in output. By 1890, after twenty-five years of prospecting, underground development, and production, the district offered little opportunity for significant discoveries. The principal veins had been located, probed, quantified, and even bought and sold several times over. Thus, the mining outfits produced a little more ore in 1890, but the jump in income was primarily a factor of the higher value of silver, which made the same tonnage worth more. When that value began slipping in 1891, annual income regressed in parallel.

The value of silver began declining again because the climate and market destabilized almost immediately after the Sherman Silver Purchase Act was signed into law. Economic

⁹² "General Mining News" *Mining Industry* (6/7/89): 252; "General Mining News" *Mining Industry* (6/21/89): 275; "General Mining News" *Mining Industry* (7/20/89): 124; "Latest Mining News" *RMMR* (2/12/85): 9.

⁹³ Ellis and Ellis, 1983:106; "General Mining News" *Mining Industry* (10/9/88): 197; "General Mining News" *Mining Industry* (7/12/89): 26.

⁹⁴ Schulze, Susanne. *A Century of the Colorado Census*. Greeley, CO: University of Northern Colorado, 1976, 1890-3; Canfield, 1893:106; Hall, 1891, V.3:322.

⁹⁵ Henderson, 1926:109.

reformers rebelled against a massive government subsidy for mining and profiteering among powerful capitalists, and demanded repeal. At the same time, a looming economic crisis created political uncertainty in both the United States and Great Britain, one of the main consumers of American silver. Repeating the cycle of the mid-1880s, an increasingly dour climate contaminated silver investment and industries that depended on it. The price of silver eroded from a high of \$1.09 in 1891 to \$.78 by mid-1893, an all-time low. As with the 1886 cycle, some of the small mines in the Griffith district closed, while other companies remained in sound condition because they were more efficient than before.⁹⁶

Companies assessed operations and identified ways of maintaining profitability despite the decline in silver. Managers cut wasteful spending, cancelled costly projects, and streamlined operations. They followed a common strategy practiced throughout the western mining industry and looked to labor for additional savings. In 1892, the largest companies cut wages from \$3.00 per shift, the standard in Colorado mining districts, to \$2.50. Until the cut, the Griffith district enjoyed a relatively cooperative atmosphere, and miners and management tolerated each other well. The wage reduction soured the relationship and created deep divisions that precipitated the first regional unionization movement. The Silver Creek Miner's Union facilitated strength of numbers, and the organization gained membership throughout the Clear Creek drainage. But before mine management tested the union's will to strike, political changes at the end of 1893 rearranged the economic landscape of the drainage.⁹⁷

Gold Mining in the Eastern Drainage, 1875-1893

During the latter half of the 1860s, residents in the eastern drainage between Empire and Idaho Springs watched the boom around Georgetown and Silver Plume with envy. The rush for silver fostered considerable growth in the western drainage, and in their haste to the silver mines investors took little notice of the vacant gold fields along Clear Creek.

During the early 1860s, however, it was the east that boomed, and miners and outfits produced placer gold from every viable creek. As the placer gold began giving out, prospectors successfully traced it to its source veins, which held the potential to offset diminishing returns from the exhausted stream deposits. Despite this, the region failed to make the transition from placer to hardrock mining, even as the region saw a wave of claims acquisitions and mine development that appeared to be the start of an industry. A number of outfits extracted shallow ore and found it easy to treat with conventional amalgamation techniques, but they unknowingly worked within a limited zone of oxidation. Between 100' and 200', the ore in most veins gave way to highly mineralized and refractory material that resisted amalgamation. Nearly all mining outfits were unable to win gold from the troublesome ore, and because of this and external factors, they failed almost simultaneously during 1864. Most investors gave up, distant rushes drew miners away, hardrock gold mining collapsed in the development stages, and Clear Creek received a poor reputation.

Thus, while the Griffith district boomed, the eastern drainage languished. Ore was still in the ground, however, awaiting experienced metallurgists to figure out how to extract its gold. John Collom was one of the few who achieved anything approaching success, but although he pioneered a solution to the refractory ore, few imitated him. Collom was a trained Cornish mining engineer who gained practical experience in the Michigan copper mines. When the Boston Silver Mining Association began developing the Comstock Mine near Montezuma,

⁹⁶ Henderson, 1926:216; *Report of the Director of the Mint*, 1894:20; Saxon, 1959:7, 8, 14, 16.

⁹⁷ Canfield, 1893:107; "General Mining News" *Mining Industry & Tradesman* (4/15/92): 191.

Summit County, in 1865, it hired Collom as manager. He understood that a smelter was required to reduce the silver ore there and built one of Colorado's earliest smelting furnaces. The Bay State Gold Mining Company drew Collom back over the Divide to Empire and convinced him to apply his metallurgical knowledge to refractory gold ore. Although Collom managed both operations simultaneously, he paid special attention to Bay State, building an experimental mill in Lyons Gulch that incorporated several innovations. First, he realized that roasting ore drove off excess sulphur, oxidized the material, and made it more receptive to amalgamation. James E. Lyon proved that the process worked in Central City, where the ore was similar, and Collom adapted the method to Empire payrock. Second, Collom designed an apparatus that relied on mechanical action to separate out heavy metal content from lighter waste, purifying ore for even better amalgamation. When tested, however, he found that his Collom Separator had merit but required more work. As a result, Collom limited his process at the Bay State Mill to roasting and amalgamation, which provided returns sufficient for the Bay State company. Although roasting proved to be an important solution to the ore problem, only the nearby Leibig Gold Mining & Mill Company imitated Collom's furnace. Other firms continued to struggle with traditional treatment methods.⁹⁸

Collom thought he had a solution to the milling crisis that halted gold mining throughout the drainage. He decided to build a carefully designed commercial plant at Junction City, formerly Empire Junction, before changing the settlement name again to Swansea after the smelting center in Wales (see Illustration A 1.2.14). For unknown reasons, Collom erected a smelter instead of another ore roasting plant, and when he opened for business in 1870, he found that smelting was not the solution. Instead of converting the plant for roasting, Collom sold to Richard Pierce in 1871 and retreated to Golden to develop his separator. Pierce had no better luck at Swansea than Collom, and Nathaniel P. Hill hired him in 1873 to manage part of the Black Hawk Smelter.⁹⁹

Although Hill designed the Black Hawk Smelter specifically to reduce refractory gold ore, the facility did little business with Clear Creek mines at first. The smelter operated at capacity on Gilpin County ore and had little room for additional material. More importantly, investors mistrusted Clear Creek gold mines due to the previous failures, and most of the mines lay dormant as a result. Those investors interested in the drainage looked to the west instead and poured their money into silver mines. Clear Creek possessed plenty of gold ore and was almost within sight of the Black Hawk Smelter, but the financial will to connect the two was simply not there.

In 1874, several factors finally provided investors with the confidence to seriously consider Clear Creek gold mining. One was improvement in the national economy, which recovered from a panic in 1872 and 1873. Investors were again willing to gamble on uncertain mining ventures. Another factor was that Nathaniel Hill increased the capacity of the Black Hawk Smelter, which now accepted Clear Creek ore. The last was the arrival of the Colorado Central Railroad at the base of Floyd Hill. As described above regarding the Griffith district, the railroad lowered the rates for importing goods and sending ore to Black Hawk. Production costs fell for mining companies, which now had an inexpensive outlet for their ore. The eastern drainage began the same process of discovery, development, and industrialization as the west.

That process was relatively slow to start. Small outfits reopened some of the principal mines and produced limited tonnages, while the few companies operating prior to the railroad also increased their output. John Dumont, who pioneered placer mining in 1859 at Mill City,

⁹⁸ Fell, 1979:56; Harrison, 1964:161; Hollister, 1867:247.

⁹⁹ Harrison, 1964:245.

bought the Hukill at Spanish Bar in 1871, developing it into one of the few substantial operations of the time. At Empire, Park Disbrow reopened the Conqueror, Henry Dewitt Clinton Cowles worked the Golden Era and Grand View, and David J. Ball operated the Pioneer and Pittsburgh. Ball and Cowles were among the first hardrock prospectors at Empire in 1860 and helped found both the town and Union Mining District. Ball ran an assay shop until the 1868 collapse and used the poor economic climate to his advantage. Forecasting a future revival, he bought several idle gold producers when discouraged owners offered them at low prices. Included were the Ball Placer at Lyon Gulch and the Pioneer and Pittsburgh mines.¹⁰⁰

Collom also forecast better times for gold mining and revived his idea of opening a commercial mill. Collom was ready with improved separation appliances and an effective process, securing a plant site in Idaho Springs in 1873. The following year, Collom interested Denver capitalists and his brother Charles, who organized the Collom Idaho Ore Dressing Company and built the first ore sampler in the eastern drainage. The sampler featured a small smelter, roasting furnace, and the first successful concentration process for Clear Creek's complex gold ore. In building the sampler, Collom directly contributed to mining in the eastern drainage because he provided the preponderance of small mining outfits with a needed local market. Collectively, these companies made up the bulk of Clear Creek's industry. Collom contributed again to the viability of the industry in 1876 when he helped build a larger sampler and smelter in Golden for the Colorado Dressing & Smelting Company. There, he installed a concentration process not only suited to the rebellious ore of Clear Creek, but also to complex material from elsewhere on the Front Range. The plant competed with the Black Hawk Smelter, drove smelting rates down, and provided Clear Creek's mining companies with another market for their payrock.¹⁰¹

The Golden smelter was not the only significant event that furthered mining in the eastern drainage during the mid-1870s. New York capitalists bought the Hukill and Whale from Dumont for a high price in 1876 and consolidated them under the Hukill Gold & Silver Mining Company. Both mines were poorly developed and included the marginally effective Whale Mill. The company spent a large sum on improvements, and the transaction and investment contributed to investor confidence in the area around Idaho Springs.¹⁰²

At the same time, David E. Dulaney was prospecting Red Elephant Hill, a short distance northwest of Mill City, and discovered a vein he claimed as the Free America (see Illustration A 1.2.15). Dulaney was born in Virginia in 1828, moved with family to Illinois, clerked in a St. Louis real estate office as a boy, and began buying and selling at age eighteen. In 1862, he married Sophie Nilson of Sweden, and they joined the end of the Pikes Peak rush the following year. Between 1863 and 1866, the couple moved from mining camp to camp in Gilpin and Clear Creek counties as the boom went bust, with Dulaney prospecting between jobs. The Free America was Dulaney's major discovery, proving rich after only minor development.¹⁰³

Other prospectors examined Red Elephant Hill before Dulaney, with the Comstock staked as early as 1872. But Dulaney's discovery of gold and silver stirred a local excitement in 1876, and prospectors rushed to locate their own veins. Before the working season ended, Dulaney sold the Free America to James I. Gilbert, Diamond Joe Reynolds, and William H. Moore rather than developing it himself. Reynolds, a Chicago capitalist operating railroads and a steamer line on the Mississippi River, was known as Diamond Joe for the diamond logo on his ships. When Reynolds began investing in Clear Creek County is uncertain, but he funneled

¹⁰⁰ Fossett, 1876:370, 373; Frost, 1880:275, 335; Harrison, 1964:186, 253.

¹⁰¹ Fossett, 1876:410; Frost, 1880:343; Wickersheim and LeBaron, 2005:90, 148.

¹⁰² *Colorado Mining Directory*, 1883:144; Frost, 1880:335; Wickersheim and LeBaron, 2005:113.

¹⁰³ Frost, 1880:285, 326; Hall, 1891, V.3:315; *History of Clear Creek and Boulder Valleys*, 1880:505.

money into both gold and silver mines by around 1875. Moore was a local prospector and mine owner, and his interest in the Free America was a voice of confidence in Red Elephant. Gilbert was born in Kentucky in 1823, grew up on the frontier, and established a business trading with Illinois tribes at age twenty-one. When relations with the tribes deteriorated, Gilbert moved to Iowa in 1848 and went into the lumber business. The potential profits offered by mining drew him to Georgetown in 1876, and he invested in the Queen of the West, a costly failure. Gilbert formed a partnership with Reynolds and lost more money on his second venture, the Diamond Joe, but wisely maintained his faith in Reynolds. They successfully brought the promising Free America into production.¹⁰⁴

John Coburn, another visionary, forecast a significant rush to Red Elephant Hill for the 1877 working season. Coburn was born in Ireland in 1822, began work as a shoemaker's apprentice, and, seeing a very limited future for himself, migrated with siblings to the United States at age seventeen. He got by as a shoemaker in Pennsylvania until 1861, when he began dealing cattle. Coburn made the acquaintance of investors organizing the Sterling Mining Company, who offered him the position of superintendent in 1869, providing he relocate to Idaho Springs. The mine failed within a short time, but Coburn secured a tract of land west of Mill City in 1870 and established the Downieville Ranch hotel and livery. Red Elephant was at his doorstep, and he laid out the townsite of Free America in 1876 in anticipation of the rush. Coburn's son-in-law Alexander Lawson followed suit and erected the Six Mile House hotel and tavern a short distance to the west.¹⁰⁵

Empire mine owner Anson P. Stevens also prepared for the rush to Red Elephant. Expecting high volumes of ore, he erected the Stevens Mill in 1876 on speculation. Stevens hoped that building the area's first and largest mill would provide a competitive advantage, and he was correct. The mill also fueled growing interest in Red Elephant and contributed legitimacy to the townsite.¹⁰⁶

When the working season of 1877 opened, the rush to Red Elephant began as expected. The Colorado Central Railroad contributed to the excitement when it resumed grading the Georgetown Extension. The railroad built track through Idaho Springs and past Lawson's Six Mile House on its way to Georgetown. The Colorado Central established the station of Lawson at Free America, and the Post Office Department opened a post office under the same name. Lawson and the new Red Elephant mines now had direct connections with important commercial and milling centers (see Illustration A 1.2.16).

Those individuals who planned for the rush did well. Gilbert and Diamond Joe consolidated their Free America with neighboring Boulder Nest, also purchasing the Comstock and profiting heavily. Silver Plume mine owner Enos Baxter developed the Young America, and Georgetown interests did likewise with the White. Wagons of ore started descending through Coburn's townsite to the Stevens Mill, which ran near capacity. Coburn and Lawson then saw their townsite boom into a formal settlement. The railroad, production of rich ore, Stevens Mill, and interest among wealthy investors legitimized Red Elephant as one of Clear Creek's important mining centers. By 1879, Lawson had a population of 400 supporting several mercantiles, saloons, and the two hotels. As many miners and prospectors lived on Red Elephant Hill as in Lawson, and they were unwilling to commute by foot from town. A group of individuals established the hamlet of Red Elephant on the north side in 1878 and secured a post office. The settlement remained primitive, however, because the north side lacked large mines.¹⁰⁷

¹⁰⁴ *History of Clear Creek and Boulder Valleys*, 1880:511; King, 1977:77.

¹⁰⁵ Frost, 1880:296; *Tailings, Tracks, & Tommyknockers*, 1986:2, 43, 502.

¹⁰⁶ Harrison, 1964:340.

¹⁰⁷ Bauer, et al., 1990:88, 120; Fossett, 1880:98; Frost, 1880:296; *Tailings, Tracks, & Tommyknockers*, 1986:2, 43.

In 1879, Gilbert and Diamond Joe successfully sold their property to Eastern investors, who organized the Red Elephant Mining Company. Gilbert and Moore reinvested some proceeds in the Free America Extension Mine, another rich producer. Patrick McCann, one of Georgetown's pioneer metallurgists, was so impressed with the output from Red Elephant mines that he erected a second mill at Lawson.¹⁰⁸

Like most rushes, prospectors thoroughly examined Red Elephant Hill and defined the principal veins over the course of only several years. Most productive mines fell into the hands of investors, and prospectors left. The hamlet of Red Elephant dematerialized as a result, with Post Office Department changing the name simply to Elephant in 1881, before cancelling later in the year. Mining contracted around the Free America and White veins near Lawson, continuing for several more years.¹⁰⁹

When the Colorado Central pushed through Idaho Springs and finished the Georgetown Extension, it fostered a boom that swept the eastern drainage. Seaton and Bellevue mountains above Idaho Springs saw a wave of development and consolidation (see Illustration A 1.2.17). Clinton Reed and Willard Teller, brother to Colorado senator Henry, produced from the Seaton, one of several shafts on a much larger vein system. In 1880, a group of Colorado and Chicago investors organized the Consolidated Seaton Mountain Mining Company and bought the entire mountainside to work the vein. The company began pushing the Idaho Tunnel from a low elevation to undercut the claims and intersect hidden veins. In 1881, Theodore H. Lowe and Colorado Springs capitalists assembled the Foxhall Tunnel & Mining Company, driving the tunnel to intersect another section of the vein system. Lowe was knowledgeable about Seaton Mountain and his operation was destined to become profitable. His Lowe Mining Association owned the Seaton Mine during the 1860s, building one of the earliest stamp mills in Idaho Springs. When not at the Foxhall Tunnel, Lowe managed the profitable Virginia Mine for the Olathe Gold & Silver Mining Company. Meanwhile, James Gilbert and Diamond Joe did not limit their attention to Red Elephant, purchasing the profitable Tropic Mine around 1880.¹¹⁰

In Virginia Canyon, between Seaton and Bellevue, Ohio investors established the Springfield Gold & Silver Mining Company and began development. Central City mine owners brought the Crown Point & Virginius Mine into production, while New York investors established the Emerson Gold & Silver Mining Company. On Bellevue Mountain, prospectors found several important veins, including the Specie Payment. The Sunshine Mining Company bought that claim during the late 1870s, brought it into production, and erected the Sunshine Mill at Idaho Springs. Edward W. Williams located the Champion in 1877 and sold it to the Kohinoor & Donaldson Consolidated Mining Company. At the same time, the company bought the Donaldson at Trail Run on the valley's south side and the Kohinoor on Red Elephant Hill. Manager Alfred Rickard, brother to famed mining engineer Thomas, was highly progressive and incorporated the mines into one of the most advanced operations in the eastern drainage. He purchased a well-designed mill at Spanish Bar, between the Champion and Donaldson, and built continuously operating aerial tramways to lower ore. These were among the earliest, if not first, endless loop tramways in the drainage. Rickard set another precedent at the Kohinoor Mine by installing the drainage's first electrical system in 1883. The power provided lighting at the mine with the surplus sold to subscribers in Lawson.¹¹¹

¹⁰⁸ Fossett, 1880:384; Frost, 1880:326.

¹⁰⁹ Bauer, et al., 1990:50.

¹¹⁰ *Colorado Mining Directory*, 1883:128, 136, 172; Fossett, 1880:366; Frost, 1880:3376; *Report of the Director of the Mint*, 1883:433; Wickersheim and LeBaron, 2005:136.

¹¹¹ *Colorado Mining Directory*, 1883:133, 147; Fossett, 1880:362; *Report of the Director of the Mint*, 1883:434; Wickersheim and LeBaron, 2005:89, 94, 140, 150.

Placer mining around Idaho Springs followed a trend similar to the hardrock sector. After the 1864 collapse, a few companies continued gleaning gold from the gravel of Clear Creek and tributaries. Many experienced miners understood that the bedrock floor of Clear Creek was laden with gold, but they lacked the capital to divert the creek and penetrate the thick gravel. Other companies were aware of fine gold disseminated in dry gavel banks on the valley sides and hoped to mine them with hydraulic methods as David Ball did at Empire.

The late 1870s saw large-scale placer mining primarily around Idaho Springs and Mill City, as the railroad lowered the cost of needed materials while the gold attracted investors with capital. John W. Edwards operated the Edwards Placer on Chicago Creek. He arrived in the mountains with the Pikes Peak rush, found little gold on his own, instead working as a miner near Idaho Springs. He survived the 1864 collapse, managed several hardrock operations, and bought his placer and the Robinson Mine with savings. A.S. Bennett had a similar experience, and he and John M. Osborn backed the Fall River Placer Mining Company, at the confluence with Clear Creek. The Munn & Loomis and Munn & Miller Placers produced in the same area. These and other companies cleverly adapted hardrock methods to the valley floor's thick gravel beds, sinking shafts with steam hoists and extracting deep gravel through lateral passages. The conditions were extremely dangerous for miners because the loose gravel was saturated, difficult to retain with timbering, and prone to sudden collapse. But the gold lining the bedrock floor of Clear Creek was worth the trouble and cost.¹¹²

Fall River and Chicago Creek were included in the late 1870s hardrock boom (see Illustration A 1.2.18). On Chicago Creek, J.V.W. Vanderburg developed the Little Mattie while Warren & Company worked the Kitty Clyde, both of which yielded rich ore. Most former producers at Spanish Bar were reopened. The Hukill Gold & Silver Mining Company enlarged its already profitable Hukill and Whale mines and refitted the ineffective Whale Mill. Due primarily to the Hukill company, the population of Spanish Bar rose to around 150, large enough to justify the post office of Hukill in 1879. Although the post office closed the following year, the mines only increased their output during the early 1880s.¹¹³

As the focal point of the boom, Idaho Springs assumed the same role in the eastern drainage that Georgetown did in the west, although it was smaller. The town was a center of transportation, communication, commerce, and banking, experiencing unprecedented growth. Around 400 people lived in and around town during the early 1870s, with the population nearly doubling to 730 by 1880. Most houses were of frame construction, many vernacular in appearance with no architectural style, although some featured elements of period styles including Greek Revival, Second Empire, and Italianate. The business district offered the array of stores and services expected of a thriving mining town, many in brick commercial buildings, and the Beebe House was the finest hotel patronized by dignitaries. Residents planted aspen and cottonwood trees along the streets, and E A. Benedict began publishing the *Iris*, the town's first regular newspaper. Community organizer Thomas B. Bryan embodied the intimate relationship that Idaho Springs shared with its mining industry. He was not only mayor during the late 1870s, but also directly participated in several important mining ventures including the Idaho Tunnel on Seaton Mountain and the Great Republican Mine on Chicago Creek. He and Eastern investors organized the Hoosac Mining & Milling Company in 1881 and made the Hoosac one of the area's best equipped operations.¹¹⁴

¹¹² Fossett, 1880:381; Wickersheim and LeBaron, 2005:99, 102, 125.

¹¹³ Bauer, et al., 1990:76; Fossett, 1880:370.

¹¹⁴ *Colorado Mining Directory*, 1883:128, 140, 143; Frost, 1880:293, 337; Leyendecker, et al., 2005:86; Schulz, 1976:1880-5.

Like Georgetown, Idaho Springs became a milling center as Collom predicted several years earlier. In 1877, Miles & Company built the Miles Concentration & Sampling Works, and S.H. White opened White's Concentration Mill. In 1882, San Francisco investors organized the Pacific Mining & Reducing Company and built a smelter. Although these accepted custom ore from throughout the drainage and competed with Collom, their relative success remains unknown. At the same time, the Colorado Central continued hauling considerable tonnage of payrock to the smelters at Black Hawk and Golden.¹¹⁵

Some ore came from the mines around Mill City, which received special attention because of their proximity to nearby Lawson. In 1877, prospectors crowded off Red Elephant Hill crossed the valley to examine Columbian Mountain on the south side. They found several rich gold and silver veins and developed them as the Dictator, Live Yankee, Tom Moore, Wall Street, and others. Diamond Joe, Gilbert, and James M. Daily quickly purchased the most promising group of claims, renamed them as the Diamond Joe, and developed them through the Daily Tunnel. William Moore, loosely associated with Diamond Joe, organized the Moore Mining & Smelting Company in 1880 and did well with the Murray. In a pattern similar to Red Elephant Hill, the principal mines were within walking distance from Mill City, but some prospectors and miners established their own camp farther away. In particular, they lived in a cluster of cabins on upper Silver Creek and applied that name to their camp.¹¹⁶

The local rush and railroad restored Mill City to its status prior to the 1864 collapse (see Illustration A 1.2.19). The population nearly tripled from 75 to 200 almost overnight, and community organizers asked the Post Office Department to reinstate the post office. Because another Mill City existed elsewhere, the Post Office Department required a different name, and residents chose Dumont for pioneer and founder John Dumont in 1880. Meanwhile, the population bought basic provisions in a mercantile, and miners relied on a cobbler to mend worn boots. Visiting guests had their lodging choice of the Mill City House run or the Unadilla House, named after one of the local mining companies. Residents drank in two local saloons and dined at either hotel. Dumont also featured offices for around fifteen mining companies, although many were probably the residential cabins of their superintendents. Several companies also purchased and refitted old mills at Dumont.¹¹⁷

When the Colorado Central graded up Clear Creek valley to Georgetown in 1877, it bypassed Empire because the town was several miles west of the planned route. The railroad did, however, establish a depot at Swansea, renaming the tiny community Empire Station. Despite distance, the railroad benefitted Empire, similar in scale to Lawson and Dumont. The population rose from around 150 residents during the early 1870s to more than 200 at decade's end. Although the business district, with its frame commercial buildings, was sparse with only several mercantiles and the Peck House Hotel, the small population enjoyed its own brewery and placed bets at a local racetrack.¹¹⁸

The Peck family ran the hotel and was a cornerstone of the community. When James and son Frank came to Empire in 1862, they already were versed in milling and contributed to the small industry on the West Fork of Clear Creek. James, born in 1802, was advanced in age but prepared for primitive conditions from thirty years on the frontier. During the early 1840s, Peck moved his family to Chicago, became part owner and agent of a shipping company, and welcomed son Frank. The financial panic of 1857 ruined Peck's business, and he struggled until

¹¹⁵ *Colorado Mining Directory*, 1883:160; Fossett, 1880:366; Wickersheim and LeBaron, 2005:148, 151.

¹¹⁶ *Colorado Mining Directory*, 1883:145, 156; Fossett, 1880:385; Frost, 1880:325.

¹¹⁷ *Colorado Business Directory*. Denver, CO: James R. Ives & Co. 1883, 177; Bauer, et al., 1990:47; Frost, 1880:296; *Tailings, Tracks, & Tommyknockers*, 1986:41.

¹¹⁸ Leyendecker, et al., 2005:86.

the family received word of the Pikes Peak gold discovery in 1859. James reverted to his frontier upbringing and crossed the plains with Frank in hopes of securing a better life. Like most rush participants, the Pecks realized that gold was not as easy to find as supposed, but James had the advantage of business experience, which he used to secure a position as manager at a Nevadaville mill. In 1861, father and son moved on to the Van Deren Mill at Trail Run, but soured when the community became a hotbed of Confederate sympathizers agitated by the Civil War. The Pecks abandoned Trail Run in favor of Empire in 1862, when father and son bought the Atlantic Mine on Silver Mountain. James sold his shipping business for operating capital, obtained more money from Chicago associates, and organized the Peck Gold Mining Company. They did well until the local mining crash in 1867, when Frank moved to Georgetown, married, and ran a mercantile. He returned when Empire began showing signs of life again in 1872, and the entire family converted one of their houses into the hotel and also operated several mines.¹¹⁹

Due in large part to the railroad, Empire's mining industry began reviving during the late 1870s. Some companies established during the 1860s rush, dormant for years, awoke and resumed activity when the climate improved. The Knickerbocker Mining Company initially developed the Tenth Legion on Silver Mountain in 1863, closed in 1867, and reopened in 1877. David Ball did likewise with the Pittsburg and Pioneer, which he acquired in 1866, building a mill at Empire in 1877 for the operation. The Bay State Mining Company was one of Empire's most important producers during the mid-1860s, resuming the Aorta Tunnel to undercut the Tenth Legion Vein. The company also worked the Livingston County Mine and treated ore in the Candee Mill, which it built in 1866. Park Disbrow reopened the Conqueror Mine, and William Moore brought the Empire City back into production.¹²⁰

Several deals helped the Empire revival grow into a boom. One involved the Equator Mine and mill operated by the Pecks on Silver Mountain (not to be confused with the Equator in Georgetown), originally developed in 1862 as the Aldebarren. Eastern investors purchased the property as the Great Equator Consolidated Mining Company in 1881 and made it the centerpiece of a large and profitable operation. In another, John Dumont poured money into the Benton, Neath, and Pioneer, fostering confidence through his experience. A.D. Breed initiated one of the highest profile buyouts, also in 1881. He and New York investors established the Great Republic Gold & Silver Mining Company and purchased the Silver Mountain Mine, already with \$100,000 in silver and gold to its credit. Breed was a dealer in patent medicine and funerary supplies in the Midwest and had a reputation for profitable silver mines at Caribou in Boulder County. By the early 1880s, the boom began having a dramatic impact on Empire. More people moved to town and the number of businesses doubled, creating so much competition for real estate that some individuals jumped town lots. The Pecks enlarged their hotel, the Colorado Central expanded its Empire Station depot, and Empire received a telephone system.¹²¹

The mid-1880s was an important time for eastern Clear Creek drainage as investment and improvements began yielding returns. The region continued growing and passed out of the discovery and development phase and into significant production. The mining industry increased its annual gold output from \$134,000 in 1878 to \$600,000 by 1884. These figures and other trends reflected an industry in the beginning stages of maturity. Some of the additional factors include a strong interest among knowledgeable investors, consolidation between companies, increased mechanization and formal engineering, and stratification of the workforce. Emulating silver mining in the western drainage, full transition would take years, however.

¹¹⁹ Harrison, 1964:108-113; *History of Clear Creek and Boulder Valleys*, 1880:527.

¹²⁰ Fossett, 1880:386; Frost, 1880:328; Wickersheim and LeBaron, 2005:93, 121, 141.

¹²¹ Harrison, 1964:318, 335, 343; "Latest Mining News" *RMMR* (6/19/84): 10; Wickersheim and LeBaron, 2005:139.

The eastern drainage saw the rise of large companies, but the trend was not as pronounced as in the west. Because silver fetched less than \$1.20 per ounce, the value of crude ore was too low for small outfits unless the payrock was particularly rich. As a result, prospectors and the small outfits in the western drainage readily sold to principal companies, which dominated the silver industry. The gold veins in the eastern drainage, by contrast, presented a different set of conditions that simultaneously favored both small outfits and large companies. The well-known veins were wide, deep, and consisted of complex ore ranging widely in grade. They required capital to develop and yielded limited returns per ton when extracted in economies of scale. The large veins therefore tended to be the domain of large companies. The eastern drainage also offered numerous veins too thin to interest the large companies, but rich enough to sustain small outfits. Thus, the small outfits continued to thrive in this niche.

The economic forces that affected silver mining in the western drainage during the latter half of the 1880s impacted the eastern drainage as well. The decline in silver values and an unstable climate gave some companies reason for pause. Gold production dropped by almost half, from \$600,000 in 1886 to \$317,000 the following year because much ore in the eastern drainage included some silver. When companies suspended because of the decline in silver, they produced less gold as well. The decrease was, however, very short-lived as mining investors turned from silver to gold because of its constant value of \$20.70 per ounce. The industry rebounded by 1888, producing \$522,000 in gold.¹²²

This trend was prevalent among mines around Idaho Springs because most veins had high proportions of gold. Many companies finished their initial development campaigns by the late 1880s and began regular production. Wagons hauled ore down from around twenty large mines on Seaton Mountain, including the Crystal, Freighter's Friend, Garden, Tropic, and Victor. The Gem Mine became one of the best producers and employed a relatively large crew of forty workers. The Foxhall company drove its tunnel toward the Seaton vein system, but progress was fitful because investors were wary. They were rewarded in 1890 when the tunnel undercut the system, and the company promptly secured Alfred Rickard to direct heavy production. Rickard may still have directed the Kohinoor & Donaldson Consolidated Mining Company, which made great progress with the Champion. That company sank the shaft to the impressive depth of 800' by 1889 and kept seventy miners busy extracting as many tons of ore per day. The operation was one of the deepest and most advanced for its time in the entire drainage. At Spanish Bar, existing operations continued production, and activity spread up the south side of the valley. The Stanley, in Spring Gulch, received a new surface plant in 1888. Trail Creek was especially productive, and F.F. Obiston erected a smelter there in 1885.¹²³

Backed by a sound industry, Idaho Springs grew during the late 1880s. The population nearly doubled again from around 720 early in the decade to almost 1,400. The business district expanded in parallel and not only featured the basic mercantiles, saloons, and hotels, but also specialty shops. The eastern drainage's other communities were, however, not as vibrant. Nearby veins were subject to the same problems as in the western drainage because they featured high proportions of silver. Dumont became relatively quiet and miners abandoned the camp of Silver Creek when most mines on Columbian Mountain closed. Dumont relied heavily on a handful of small operations and the Albro Mine, a historic gold producer on the valley's north side. The rush to Lawson dissipated, and activity there contracted to the principal mines on Red Elephant Hill, the small operations having closed. On the north side, employees of several companies

¹²² Henderson, 1926:109.

¹²³ "General Mining News" *Mining Industry* (5/18/88): 13; "General Mining News" *Mining Industry* (8/10/88): 67; "General Mining News" *Mining Industry* (4/26/89): 190; "General Mining News" *Mining Industry* (3/6/90): 119; "Latest Mining News" *RMMR* (6/5/84): 10; "Latest Mining News" *RMMR* (7/17/84): 10.

occupied the hamlet of Red Elephant, and on the south side, the Red Elephant (formerly Free America), Joe Reynolds, and White produced ore. Several other outfits joined forces as the Red Elephant Tunnel Company in 1888, developed several veins at depth, and produced enough ore to feed the Stevens Mill. In total, Lawson remained stable because of its mines and role as a transportation node on the Colorado Central Railroad. The town retained its population of around 500, and residents supported a mercantile, saloon, cobbler, and at least one hotel.¹²⁴

The town of Empire followed a trend paralleling Lawson. Approximately the same number of people lived in town, patronizing similar businesses. But because Empire had a longer history, it featured a few more industry services, such as blacksmiths, carpenters, and contractors. Empire also was a transportation stop on the heavily used Berthoud Pass route into North Park.¹²⁵

Most of Empire's mills were idle, however, due to their age. During the early 1860s, companies equipped the original generation of mills with mercury amalgamation because the gold ore was relatively simple. But when simple ore later gave way to complex material, few companies refitted their mills for concentration as elsewhere in the drainage. Although highly inefficient, amalgamation continued to recover just enough gold to keep operators content. During the mid-1880s, John Dumont leased the Bay State Mill and David Ball ran the Pioneer Mill, largely unchanged. The Barret & Fletcher Mill (formerly Knickerbocker) accepted custom ore from Dumont's Benton Mine, Bay State's Livingston County Mine, and Ball's Pittsburg Mine, because it recovered just enough gold. As the companies went deeper underground during the 1880s, the character of the ore changed more and rendered nearly all the mills in Empire obsolete. Yet, mill owners still resisted necessary improvements, forcing mining outfits to ship ore by wagon to Empire Station and on rail to smelters at Denver, Golden, and Boulder.¹²⁶

The lack of milling capacity was one of several factors suppressing mining around Empire, and a general decline in underground ore reserves was another. After nearly twenty-five years of production, miners exhausted small veins and placer deposits, leaving a fewer number of deep ore bodies. Mining thus contracted around the most developed properties, including the Conqueror, Pittsburg, Tenth Legion, Pioneer, Benton, and Neath.

The Kohinoor & Donaldson company may have been the only new venture of significance during the late 1880s, plucking the industry out of decline. In 1887, the British company purchased several mines above Empire, consolidated them, and sought capital for additional acquisitions. Around this time, George G. Vivian joined the company as its American representative and learned of Empire's milling crisis from Dumont. The two were associates and cooperated on several mines around Freeland years earlier. Vivian concluded that if he built a concentration mill at Empire, the facility would be profitable, both supporting the company's Empire operations and the community's other outfits. By charging for custom work, the company could recover construction costs. In 1888, Vivian thus erected the first new concentration mill at Empire in ten years. The mill bolstered the sagging industry through local ore treatment but was unable to solve Empire's second major problem of declining ore reserves.¹²⁷

The early 1890s was a time of irregularity and inconsistency in the eastern drainage. The instability of the silver market continued to influence a sometimes inverse relationship between silver and gold. In 1889, for example, the eastern drainage enjoyed a spike of gold production

¹²⁴ *Colorado Business Directory*, 1889:392; "General Mining News" *Mining Industry* (7/6/88): 17; "General Mining News" *Mining Industry* (8/31/88): 99; "Latest Mining News" *RMMR* (7/17/84): 9; "Latest Mining News" *RMMR* (11/27/84): 8.

¹²⁵ *Colorado Business Directory*, 1889:325.

¹²⁶ Harrison, 1964:347; "Latest Mining News" *RMMR* (7/31/84): 11.

¹²⁷ "General Mining News" *Mining Industry* (3/23/88): 8; "General Mining News" *Mining Industry* (6/15/88): 12.

because the value of silver remained low and investors turned to gold for security. When the federal government passed the Sherman Silver Purchase Act in 1890, the elevated price of silver encouraged a shift back toward silver mining. As a result, gold production declined slightly in 1890 and 1891. But when anti-silver reformers threatened to repeal the act, the silver market destabilized so much, it impeded gold mining, as well. Companies that produced ore primarily with silver and secondarily gold either cut back or suspended altogether. Gold production suffered as a result. The eastern drainage generated \$522,000 in gold in 1889, which fell to around \$440,000 for 1890 and 1891. The following year, production plummeted to \$314,000.¹²⁸

Idaho Springs was least affected because its veins had high gold content, which countered the silver problem. The principal operations on Seaton and Bellevue mountains to the north, and around Spring Gulch and Chicago Creek to the south, continued producing heavily. Idaho Springs was home to twelve mills, some of which were custom samplers, others independent concentration facilities, with the majority dedicated to specific mining companies.

The impacts of the silver problem became more noticeable and severe in a westward progression away from Idaho Springs, paralleling a higher proportion of silver in the ore. At Spanish Bar, many mines were idle while their operators monitored the market, and only the richest properties maintained production. Charles A. Gehrmann, formerly manager of the Foxhall Tunnel, kept ore flowing out of the Salisbury Mine on the valley's north side. The Hukill Gold & Silver Mining Company and Stanley Mining Company worked the south side. In 1892, all merged as the Consolidated Stanley Mining Company, working the entire property as a single, massive operation. The company built a new smelter in supplement of the Whale Mill, making the operation one of the most important and reliable in the eastern drainage.¹²⁹

Lawson weathered the silver fluctuations better than most other communities as substantial mines on the valley's north and south sides imparted an atmosphere of vibrancy. The Red Elephant, American Sisters, Donaldson, Joe Reynolds, and new Bellevue-Hudson kept Lawson's population stable at 500. Dumont did not fair nearly as well, relying primarily on the Albro, Syndicate, Senator, and West Albro. Empire was largely quiet as residents waited for conditions to change, which they dramatically in 1893. At the end of the year, Colorado entered one of its most trying periods, which affected gold and silver communities differently.¹³⁰

The Silver Crash, 1894-1897

At the end of 1893, a compendium of political decisions and economic trends at first undercut mining across the American West and then precipitated one of the nation's worst depressions. The economy was on the brink of collapse immediately prior to the catastrophe, and the crisis inflamed tensions in the federal government regarding the silver policy. Hoping to avert a collapse and mollify the anti-silver faction, President Cleveland called a special session of Congress and repealed the Sherman Silver Purchase Act, effective November, 1893. At the same time, Britain adopted a gold standard, abolished its silver standard, and extended this policy to its empire in the Far East. Britain was one of the largest consumers of American silver and shipped much of that metal to India for coinage. The American economy began disintegrating as a result, and the market for silver promptly evaporated. The metal's value plummeted from \$.78 to \$.64 per ounce by March 1894. Only four years earlier, the metal fetched more than \$1.00 per ounce, and many mining companies predicated their finances on this

¹²⁸ Henderson, 1926:109.

¹²⁹ Canfield, 1893:110; "General Mining News" *MIT* (3/31/92): 152; "General Mining News" *MIT* (6/9/92): 255.

¹³⁰ *Colorado Business Directory*, 1892:409; "General Mining News" *Mining Industry* (4/2/91): 168; Hall, 1891, V.3:323.

figure. The mining industry collapsed, investors were bankrupted, and those that survived were not about to reinvest in silver. Mining companies across the West suspended operations and discharged thousands of workers. A financial panic then swept the West and rippled out to the rest of the nation, ushering in a depression that lasted through much of the 1890s.¹³¹

Colorado was hit particularly hard because it depended on silver. In total, 45,000 workers lost their jobs, 435 mines closed, and 377 businesses failed. Clear Creek drainage was one of a few exceptions to the trend, defying the bust for reasons different in the eastern and western ends of the valley.¹³²

The Silver Crash struck an initial blow to the western drainage, where silver was the principal metal of interest. Most companies suspended operations during 1894, laying off around 870 workers and cancelling business with consultants. The western drainage then saw an exodus of talented miners and entrepreneurs, who left to find income elsewhere. Retail and supply enterprises closed, the service sector was in trouble, and community wealth disappeared. The western drainage never fully recovered from the damage.

Those individuals who stayed were rewarded for their perseverance because the shutdown lasted a relatively brief time. The largest companies tepidly reopened their mines in early spring 1894, other companies followed, and the industry returned to a regular production schedule by summer. The industry remained, however, far below its previous state of prosperity. Production toppled from \$1.7 million in silver and \$300,000 worth of lead in 1893 to \$1 million in silver and \$200,000 in lead by 1895. The figures reflect a loss of nearly half, but not a parallel decrease in the amount of work. Companies produced almost the same tonnage of ore as before, but the low value of silver reduced its worth.¹³³

The changed financial conditions impacted the industry in several ways. Many large companies continued production but resigned themselves to lower profits. Some also reduced elective operating costs and cancelled improvement and underground exploration projects. A few, however, invested in new facilities that increased production and efficiency to offset silver's low value. At the Mendota, one of Silver Plume's best, owner Robert Old financed a new set of machinery in 1895. Both large and small companies under heavy debt did not fare as well, with many going bankrupt. The Colorado Central Consolidated Mining Company, one of Georgetown's flagship operations, failed in 1895 and was sold at a sheriff's auction. Many other companies remained solvent but suspended operations hoping the value of silver would rise again. It did, but twenty years later. Most companies were unable to wait that long and either resumed production or left the business.¹³⁴

Although the Silver Crash dragged down the western drainage, the event ironically pushed the eastern drainage into its greatest period of production. Mining investors turned away from silver and redirected their remaining capital toward gold, which fetched a constant \$20.70 per ounce due to federal policy. The eastern drainage featured dozens of mines with proven gold reserves, as well as other properties of great potential. Investors began taking interest as early as 1894, although they restrained their spending due to the poor economy. Capitalists bought into the principal companies at first, and, as gold emerged from the region, began speculating on nascent operations as well. As a result, mining gathered momentum and reached a peak during the late 1890s, as reflected by production figures. Gold more than doubled from \$314,000 in 1892 to \$663,000 by 1894 and continued climbing until 1897, when it declined slightly. Because

¹³¹ Brown, 1984:194; *Report of the Director of the Mint*, 1894:26, 30; Saxon, 1959:7, 8, 14, 16; Stone, 1918, V.1:437.

¹³² Leyendecker, et al., 2005:279.

¹³³ Henderson, 1926:109.

¹³⁴ "General Mining News" *MIT* (12/12/95): 263; "General Mining News" *MIT* (9/19/95): 106.

of this trend and continuing silver mining in the western drainage, Clear Creek County's industry was Colorado's third largest employer in 1895 and approached the same status in output.¹³⁵

The boom swept Idaho Springs and its gold mines in advance of the rest of the eastern drainage (see Illustration A 1.2.20). The area was ready for investors by 1895 because the mines were well developed, the town fairly sophisticated with electric lighting and a water system, and a dozen ready mills. The Dewey Brothers and Chamberlain samplers ran at capacity, and the Humphrey, Mattie, Mixsell, and other mills contracted with individual mining companies. The Donaldson Mill at Spanish Bar accepted custom ore when not treating payrock from the other Donaldson & Kohinor properties. The Champion on Bellevue Mountain was among the others, and approximately thirty leasing parties sent as many tons of ore per day down the tramway to the mill. The Consolidated Stanley Mining Company, also at Spanish Bar, encountered several rich gold veins in the Hukill and Whale. On Seaton Mountain, W.E. Renshaw developed the Gem Mine into one of the most important operations near Idaho Springs.¹³⁶

The Crown Point & Virginia Gold Mining Company at the head of Virginia Canyon was a vehicle for milling advancements during the mid-1890s. S.A. Josephi was an investor who valued gold for its stability and bought the Crown Point & Virginia immediately after the Silver Crash. He was born in New York City in 1856, studied science at university, and migrated to Leavenworth, Kansas, at age twenty. There, Josephi found a job as cashier at a manufacturing firm and became a partner in the business. He moved to Texas in 1882 and founded a bank, coming to Colorado four years later to take advantage of the state's industrial potential. Within a short time, Josephi became aware of oil discoveries near Florence and invested his capital in the Colorado Oil Company, which also bought him the position of manager. The firm did well, and Josephi sold for a large sum and moved to Denver, where he reinvested in other lucrative ventures, including several silver mines. When the Silver Crash threatened these ventures, Josephi scrambled for gold. The Crown Point & Virginia had a long history as a profitable producer, but the easily treated ore was already exhausted, leaving material low in grade and difficult to treat in the company mill. Thus, the company shipped ore to the Newton and Silver Age mills in Idaho Springs, which charged treatment fees. Perceiving the fees as lost profits, Josephi and another metallurgist devised a concentration process for the complex gold ore and refitted the Crown Point & Virginia Mill accordingly. The process proved to be effective and became an example for other mining companies with similar ore. Companies then imitated the process, which rendered large reserves of low-grade ore profitable to produce.¹³⁷

The Silver Crash also gave life to one of the most ambitious tunnel projects of its time in Colorado, with Idaho Springs as its seat. As early as the 1860s, Colorado mining promoters pushed the idea of undercutting mountains with long tunnels. Exemplified by the Burleigh Tunnel at Silver Plume, promoters claimed that the long passages offered numerous benefits. For one, the tunnels allowed mine owners to efficiently work their veins from the bottom up, using gravity to draw blasted ore down. In another, a tunnel could serve as a transportation artery for adjacent properties as well, with the owners leasing rights-of-way from the tunnel company. Most intriguing of all, however, was the potential to intersect and claim ownership over hidden veins, which inexperienced investors assumed were likely.

In 1893, Samuel Newhouse, Charles C. Parsons, and others organized the Argo Mining, Drainage, Transportation & Tunnel Company not only to fulfill the above intentions, but also something grander. They proposed driving a tunnel from Idaho Springs north for seven miles to

¹³⁵ "General Mining News" *MIT* (11/14/95): 211; Henderson, 1926:109.

¹³⁶ "General Mining News" *MIT* (9/26/95): 121; "General Mining News" *MIT* (10/10/95): 145; "General Mining News" *MIT* (10/17/95): 159; "General Mining News" *MIT* (11/21/95): 224.

¹³⁷ Hall, Frank *History of Colorado V.4*. Chicago, IL: Blakely Printing Co., 1895, 485.

undercut the Central City mines, build a massive mill at the portal, and haul and treat ore from the depths of that district. Newhouse also sold the tunnel as a massive drain, eliminating the need for costly pumping. By planning the tunnel at Idaho Springs, the company would start with Seaton Mountain, followed by the gold-bearing area to the north, and realize immediate business. The proceeds could then be applied to the Central City extension.¹³⁸

Newhouse and Parsons solicited beneficiary mining companies for capital. Most to the north of Seaton Mountain refused because they thought the project unrealistic. Time proved them wrong. Newhouse and Parsons gathered enough money from outside investors and a few companies on Seaton Mountain to begin the tunnel, recognized by the mining industry as both the Argo and Newhouse. The tunnel was well designed for its function. It was 10'x12' in-the-clear with a double track for ore trains and water channel down the center. Initially, mules pulled the trains, but the company planned electric locomotives once production began.¹³⁹

As the tunnel neared Seaton Mountain in 1895, an unforeseen issue stymied progress. Newhouse and Parsons underestimated the logistics of obtaining easements through the myriad claims on the mountain, and the company fitfully pushed the tunnel as lawyers secured agreements. By 1897, miners finally undercut Seaton Mountain, made connections with several mines, and began hauling out ore. Although the easement issue stopped progress again, Idaho Springs celebrated the Seaton Mountain achievement, the company was validated, and more subscriptions sold.¹⁴⁰

Peak Production in the Eastern Drainage, 1898-1918

As the 1890s progressed, a number of factors brought gold mining in the eastern drainage into its greatest period of activity. First, the nation's economy began recovering from the post-Silver Crash depression. The rebound started in the East and reached the West by the late 1890s, and as the economic climate stabilized, investors risked capital. Mining companies were thus able to finance their development projects. Second, transportation improved, railroad traffic increased, and goods and services were readily available again. Third, mine and mill owners were more than willing to extend themselves and improve their properties or sell or lease them to investors who could. Fourth, the general demand for industrial metals such as copper, lead, and zinc greatly increased due to economic revival.

The final factor was the production and concentration of low-grade ores in economies of scale through massive investment and mechanization. Several mining companies in San Juan County pioneered this practice during the mid-1890s, and when capital and credit became available again at decade's end, other large companies imitated them. In employing advances in mining technology and milling methods, the companies rendered the low-grade material, in its abundance, economical to produce. While the movement gave rise to companies larger than in previous years, even small outfits profited when they supplanted labor with machinery and ensured high volumes of ore per shift.

Improved technology, available capital, and extraction of large tonnages of ore translated into tangible metals. Although gold production tapered from a peak of \$793,000 in 1896 down to \$465,000 in 1900, the figure was still relatively high. The figure would have been greater were it not for a general labor strike that shut down a number of mines and mills in 1899. At that time, the State of Colorado mandated an eight-hour shift law for millworkers, with some milling

¹³⁸ Warwick, A.R. "The Newhouse Tunnel." *Mining Reporter* (4/24/02): 398; *Mining Reporter* (1/9/02): 117.

¹³⁹ Warwick, 1902.

¹⁴⁰ Callbreath, James F. "The Mineral Resources of Clear Creek County." *Mining Reporter* (8/24/99): 120; "General Mining News" *Mining Industry Reporter* (7/97): 25; "General Mining News" *MIT* (8/15/95): 45; *Report of the Director of the Mint*, 1899:78.

outfits complying and others not. The compliant companies, however, also reduced wages on grounds that millworkers were on the job for fewer hours. But millworkers demanded eight hours and no reduction in pay, and when companies balked, the Mill and Smelterworkers' Union called a general strike. When the Western Federation of Miners, the largest union in the industry, struck in sympathy, miners and millworkers across the state walked off the job, paralyzing the mining industry for more than a month.¹⁴¹

The strike interrupted gold production in Clear Creek drainage, but the effect was short-lived. Gold mining in the eastern drainage peaked shortly after 1900. Workers generated \$930,000 in gold in 1902, and, although the yield tapered again afterward, the amount varied between \$500,000 and \$700,000 in subsequent years. The number of active mines increased in parallel with production. A total of 250 mines were scattered throughout the county in 1897, and by next year, the eastern drainage alone was home to 200 (see Illustration A 1.2.21). The population increased as well, mirroring greater activity at the mines. In 1900, 2,592 people lived in Idaho Springs, double the population of 1890. In the rest of Clear Creek County, the number of residents increased from 7,184 in 1890 to 8,794 by 1900. Given that the Griffith district still suffered from the exodus that followed the Silver Crash, most new residents lived among the county's gold mines.¹⁴²

The increase in mines, workers, and ore tonnage stimulated mill activity. Each town in the eastern drainage had several concentration mills dedicated to the localized industry, and Idaho Springs featured a record twenty such facilities, as well as three additional ore sampling plants. Many existing mills traded hands, and companies erected at least six new plants. Some mills failed, even though metallurgists had a better grasp of how to treat complex gold ore than in previous decades. The Newton Mill, built by the Newton Gold Mining & Milling Company in 1897, was among the most important. Although the mine was on Chicago Mountain south of Idaho Springs, the company erected the mill at the Newhouse Tunnel in hopes of capturing some of the ore hauled out. Metallurgists built new smelters as far away as Golden. The Golden Pyretic Smelter, for example, was built in 1901 specifically for Clear Creek ore, the operator doubling capacity in 1903.¹⁴³

The Allen Mill was among the most reliable local facilities, and it also exemplified how the gold boom provided opportunity for women experienced in the mining industry. Maria A. Allen inherited the mill in 1894 when her husband James died of pneumonia. James erected the facility during the early 1890s, married Maria in 1892, and the couple ran the mill together. James attended to mechanical aspects, and Maria the business matters. Unwilling to give up the business after James died, Maria hired a metallurgist and leased the Decatur and General Thomas mines to feed the mill. In 1898, she leased the plant to the Butler Mining & Milling Company but stipulated rights to continue treating ore from her own operations. The Allen Mill was not the only female-owned mining business. During the late 1890s, Vermont stenographers Mary H. Husted and Ella H. Chisholm vacationed in Georgetown, visited Empire, and became seized with gold fever. They used their savings to organize the Atlantic Gold Mining & Milling Company, buying the venerable Atlantic Mine from Frank Peck. They hired Mrs. E. C. Atwood as manager, and she personally supervised the operation. Atwood lived in Empire and was a self-made mining woman, which was difficult in a male-dominated industry. After losing money on several ventures, she vowed to make a profession of mining and learned the industry. Atwood began her

¹⁴¹ Henderson, 1926:109; "Mining News" *Mining Reporter* (7/20/99): 54.

¹⁴² Henderson, 1926:109; "Mining News" *Mining Reporter* (9/15/98): 17; *Report of the Director of the Mint*, 1898:117; Schulz, 1976:1890-3; Schulz, 1976:1900-4.

¹⁴³ *Colorado Mining Directory, 1898*. Denver, CO: Western Mining Directory Company, 1898, 142; "Mining News" *Mining Reporter* (10/3/01): 258; "Mining News" *Mining Reporter* (12/4/02): 470; *Report of the Director of the Mint*, 1902:111.

professional career in Clear Creek County and expanded her horizons to Cripple Creek, Boulder County, and California. Finally, shortly after 1900, Julia W. Anderson was owner and active manager of the Harrison Mine, in gold production near Idaho Springs.¹⁴⁴

The principal reason why Idaho Springs was home to more than twenty mills was the huge tonnages of ore flowing down from the surrounding mines. Some mines were recent, others old properties renamed by new owners, and many were historic producers operated by well-established companies. To increase production, the companies mechanized their mines to a greater degree and employed larger workforces than in previous years. Professionally engineered compressed air systems, steam hoists, ventilation blowers, and multiple buildings became common. A few companies invested extravagant sums on both their underground workings and surface facilities, creating some of the most advanced and deepest operations in the entire drainage. Such mines and the large-scale property acquisitions on which they were predicated were characteristic of a mature industry.

Seaton Mountain was a center of advanced, heavily productive operations. The Seaton Mining & Milling Company and the Foxhall Tunnel & Mining Company cooperated on a complex maze of underground workings. The Seaton company sank the Seaton Shaft to great depths and installed a costly surface plant. Instead of hoisting ore to the surface, however, the company sent approximately forty tons per day out the tunnel, saving energy costs. The Foxhall Tunnel company not only provided access to the Seaton's deep workings, but also those of adjoining properties. The Foxhall company charged the outfits a fee to extract ore through the tunnel, increasing its income.¹⁴⁵

The Freighter's Friend, Franklin, and Silver Age were a group of neighboring mines on Seaton Mountain subject to consolidation. The Silver Age Mining & Milling Company worked the Silver Age at a profit, and William E. Renshaw operated the other two since the mid-1890s. Eastern investors targeted the three mines for acquisition, and because they were proven producers, their owners sold only at high prices. Planning extensive development, investors organized the Consolidated Franklin Mining Company in 1902 and began major improvements including large-scale machinery. The company also acquired the Wilkie Mill in Idaho Springs to treat the ore, joining the ranks of the region's important operations.¹⁴⁶

Renshaw, wealthy from the sale of the Freighter's Friend and Franklin, made even more money from other Seaton Mountain consolidations. He leased the Gem Mine from William Benellack & Company and worked it with adjoining claims he owned. Investors from the Midwest targeted the group for buyout and organized the Consolidated Gem Mining Company in 1900 to allocate necessary capital. They paid Benellack and Renshaw handsomely for the properties, and because Renshaw had extensive experience, the company also retained him as manager. Renshaw installed advanced surface facilities with one of the earliest sets of electrified machinery, for work at great depth. Under Renshaw, the Gem produced heavily for decades.¹⁴⁷

The Sun & Moon Mining & Milling Company operated what may have been the largest and most heavily equipped mine in the eastern drainage. J.W. Britton and G.G. Lowden organized the company in 1897 or 1898 to work the neighboring Sun & Moon and Minott shafts on northern Seaton Mountain. The company poured money into surface facilities such as large hoists, boilers, and air compressors to sink the shafts deeper and block out extensive segments of

¹⁴⁴ *Colorado Mining Directory, 1901*. Denver, CO: Wahlgreen Printing Co., 1901, 34, 42; Myres, Sandra L. *Westering Women and the Frontier Experience, 1800-1915*. Albuquerque, NM: University of New Mexico Press, 1999, 264; Zanjani, Sally. *A Mine of Her Own: Women Prospectors in the American West, 1850-1950*. Lincoln, NE: University of Nebraska Press, 2002, 104.

¹⁴⁵ *Colorado Mining Directory*, 1898:139; "Mining News" *Mining Reporter* (1/1/03): 15; *Report of the Director of the Mint*, 1902:126.

¹⁴⁶ *Colorado Mining Directory*, 1898:144; "Mining News" *Mining Reporter* (11/13/02): 405; "Mining News" *Mining Reporter* (4/24/02): 412.

¹⁴⁷ *Colorado Mining Directory*, 1898:139; *Colorado Mining Directory*, 1901:41; "Mining News" *Mining Reporter* (9/17/03): 265.

a gold vein. By 1901, the company connected both shafts with lateral drifts and extracted ore from depths of 400'. When manager H.N. Sims found that the ore continued downward, he installed yet larger hoists and compressors. All the while, the company generated enough ore not only to pay for improvements, but also provide high profits.¹⁴⁸

A movement to bore long and costly tunnels underneath nearly every mountain known for ore was characteristic of the eastern drainage's peak. A number of companies looked to the Newhouse and Foxhall tunnels as models for engineering, service, and resolution of logistical issues such as easement acquisition. Like the Newhouse, companies planned tunnels to be haulageways and drains for specific groups of mines, but hoped to charge rights-of-way to neighboring property owners. Between 1898 and 1903, various companies commissioned at least twenty tunnels, many completed and in service within several years of start.

Because Seaton Mountain already featured the Newhouse and Foxhall, it had space for only a few new tunnel projects. The Edgar Consolidated Gold Mining Company invested heavily in a tunnel from Idaho Springs underneath Virginia Canyon to Seaton. Within a short time, the Edgar Tunnel became one of the area's important operations. The Big Revenue Gold Bullion Mining Company imitated the Edgar operation and started another tunnel in the same area.¹⁴⁹

Although Bellevue Mountain had fewer veins of substance than Seaton, it drew five major tunnel projects, including the appropriately named Bellevue Tunnel. Another was the Centurion, driven in 1902 by Colorado Springs investors to undercut the Champion Vein. The Champion originally was one of three deep shaft mines owned by Kohinoor & Donaldson, bought when the outfit went bankrupt. S.A. Josephi backed the Knickerbocker Gold Mining, Milling, Tunnel & Transportation Company in 1897, spent two years boring a tunnel, and began production around 1900.¹⁵⁰

The Big Five was among the most extensive tunnel projects of the time near Idaho Springs. William P. Daniels and partners owned claim groups on Bellevue Mountain, at Ward in Boulder County, and near Howardsville in San Juan County. Confident in the tunnel strategy, they funneled enormous capital into separate projects at each place, and should any one fail, the other two would offset the loss. Daniels and partners merged assets under the Big Five Tunnel, Reduction & Transportation Company in 1900, naming each bore the Big Five, including the one in Bellevue. The Ward and Bellevue projects proved successful by 1903, while the one in San Juan County was a failure.¹⁵¹

R.C. Vidler pursued a strategy similar to the Big Five company, but his three tunnels were all within Clear Creek County. In 1901, he convinced Colorado capitalists to simultaneously fund the Vidler Tunnel in the Argentine district, the East Red Elephant Tunnel at Lawson, and the Luciana Tunnel on Bellevue. Vidler planned to drive the Luciana easterly through Bellevue and underneath Seaton, but ran out of funds.¹⁵²

Spanish Bar was center to several tunnel projects, as well as ongoing production. The Consolidated Stanley Mining Company extracted thirty tons of ore per day from the Hukill and Whale tunnels during the late 1890s. The Hukill followed the vein on the north side of the canyon and the Whale on the south side. A complex of compressors, buildings, power plant, and the Whale and Plutus mills was located between. Manager Charles A. Gehrman realized that the

¹⁴⁸ *Colorado Mining Directory*, 1898:144; *Colorado Mining Directory*, 1901:49; "Mining News" *Mining Reporter* (8/8/01): 105; "Mining News" *Mining Reporter* (10/3/01): 258; "Mining News" *Mining Reporter* (10/9/02): 296; *Report of the Director of the Mint*, 1903:126.

¹⁴⁹ *Colorado Mining Directory*, 1898:138; *Colorado Mining Directory*, 1901:39; "Mining News" *Mining Reporter* (6/9/04): 590.

¹⁵⁰ Callbreath, 1899; *Colorado Mining Directory*, 1898:140; "Mining News" *Mining Reporter* (2/23/99): 16; "Mining News" *Mining Reporter* (7/23/03): 79.

¹⁵¹ *Colorado Mining Directory*, 1901:34; "Mining News" *Mining Reporter* (9/13/1900): 152; *Report of the Director of the Mint*, 1903:126.

¹⁵² "Mining News" *Mining Reporter* (8/22/01): 145; "Mining News" *Mining Reporter* (11/5/03): 442.

veins connected deep underneath the valley floor, which previous operators left undeveloped because of groundwater. He commissioned the Gehrman Shaft on the segment and was rewarded with heavy production. The Stanley company had so much milling and power capacity that it accepted custom ore from local mines and provided electricity to Spanish Bar and the immediate area. And yet, Gehrman added more machinery in 1902, increasing production.¹⁵³

J.H. Shepherd presided over the Shafter Mine, the other major operation and fourth to drive a deep tunnel at Spanish Bar. The Shafter Mining & Milling Company was among the most profitable in the area, extracting ore from extensive workings and processing material in its own mill. In 1901, Shepherd commissioned the Big Four Tunnel to undercut the workings at depth, and within three years, pushed it to a successful length of 4,400'.¹⁵⁴

The Mayflower Tunnel was the fifth at Spanish Bar. The Lord Byron Mining Company owned a collection of productive properties in Spring Gulch, including the Lord Byron, Lord Wellington, and Mayflower. The directors thought that the veins could be worked more efficiently through a haulage tunnel than the existing shafts, and started the tunnel south from the Stanley property in 1900 (see Illustration A 1.2.22). The principal complication was three miles of solid rock. The project got off to a good start, but the cost became too great for investors, who lost interest after a few years.¹⁵⁵

The Newhouse Tunnel, the most costly, if not successful haulageway and drain, was well on its way to the goal of Central City (see Illustration A 1.2.23). The Argo Mining, Drainage, Transportation & Tunnel Company stopped work in 1897 when the tunnel reached 7,800' in length due to easement issues. At this distance, the tunnel was already through Seaton Mountain, and the company increased its customer base by raising connections with the Gem, Sun & Moon, and other heavy producers. Electric trains hauled a constant flow of ore out the tunnel, most concentrated in the Newton Mill. By 1899, company lawyers secured more easements, allowing miners to resume progress. They lengthened the tunnel to 13,000' over the course of three years, and although this was more than most other tunnels in Colorado, the miners were only half way to Central City. After several more interruptions, the company finally undercut Quartz Hill near Central City in 1910.¹⁵⁶

Dumont was one of the few pockets in the eastern drainage relatively quiet during the time of peak production. The town remained small with several businesses, the Mill City House hotel, and a population of approximately 100. Long-term resident miners kept several venerable producers in operation during the late 1890s. Simon Dingle leased the Albro Mine, James Ninan worked the Pioneer and ran its mill, and others extracted ore from the Alkire.¹⁵⁷

The Pioneer and Senator mines became the subject of acquisitions and improvements, but went bust. Investors bought the Senator in 1900, built a mill at Dumont, and worked the mine for a year. The mill proved to be ineffective, and instead of shipping the ore by rail to a smelter, the owners suspended operations. The Kokomo Pioneer Mining Company bought the Pioneer from Ninan in 1901, refitting the mill because it was unprofitable. The improvements, however,

¹⁵³ *Colorado Mining Directory*, 1901:37, 48; "Mining News" *Mining Reporter* (9/21/98): 17; "Mining News" *Mining Reporter* (7/4/01): 10.

¹⁵⁴ *Colorado Mining Directory*, 1898:144; *Colorado Mining Directory*, 1901:48; "Mining News" *Mining Reporter* (8/8/01): 104; "Mining News" *Mining Reporter* (11/17/04): 533.

¹⁵⁵ "Mining News" *Mining Reporter* (11/29/1900): 345; "Mining News" *Mining Reporter* (2/21/01): 118.

¹⁵⁶ "Newhouse Tunnel Complete." *Mining Science* (11/24/10): 499; "General Mining News" *MIR* (7/97): 25; "Mining News" *Mining Reporter* (1/25/1900): 52; *Report of the Director of the Mint*, 1903:126; Warwick, 1902.

¹⁵⁷ *Colorado Business Directory*, 1898:415; *Colorado Mining Directory*, 1898:124; "Mining News" *Mining Reporter* (9/8/98): 17; "Mining News" *Mining Reporter* (9/8/98): 17.

proved to be a waste of capital, and the company then sold to another equally unsuccessful firm.¹⁵⁸

Lawson was nearly as quiet as Dumont, but the substantial veins on Columbian Mountain and Red Elephant Hill attracted ventures and tunnel projects. Charles Lawson and Chicago investors owned the Joe Reynolds Mine on Columbian Mountain and concluded that a haulage tunnel was a logical step to efficiently extract its deep ore. Because the project would be costly, they interested Robert Old and John Kemp, who owned adjoining mines. Old was an experienced investor in Georgetown and held the Nil Desperandum, while Kemp ran the Murray, as well as mines in Central City. In 1897, the parties commenced the Princess of India Tunnel at the mountain's base to undercut the three mines. Kemp was the first to benefit when the tunnel struck the Murray Vein in 1898, followed by the Joe Reynolds and Nil Desperandum two years later. The tunnel proved to be a wise investment both for the owners and Lawson, yielding significant tonnages for years afterward.¹⁵⁹

On the north side of the valley, other companies were trying to develop the depths of Red Elephant Hill. R.C. Vidler and associates purchased a group of claims, organized the East Red Elephant Mining & Milling Company in 1902, and began the Red Elephant Tunnel, Vidler's third such project in the county. Meanwhile, Albert E. Reynolds (no relationship to Diamond Joe Reynolds) was at work on the Red Elephant Group. Reynolds was a Colorado pioneer, Indian trader, and mining expert who made a fortune investing in dozens of mines across the state. He did particularly well in the Creede district and organized the Commodore Mining Company during the late 1890s to acquire a mine there by the same name. The company became an umbrella organization for mines across the state, including the Red Elephant Group. Previously, Chicago interests consolidated the Boulder Nest and adjoining claims, started a tunnel, but mismanaged the company. Purchasing the property in 1902, Reynolds followed his usual pattern and dispatched a trained engineer to systematically develop the workings. Once the mine was in production, the engineer resumed work on the Commodore Tunnel, finishing it during 1904.¹⁶⁰

The above operations and a few small outfits were vital to the town of Lawson, home to around 200 people, a saloon, hotel, and several mercantiles. As activity on Columbian and Red Elephant contracted around the principal mines after 1900, the population shrank to only 100, and Lawson assumed a status similar to Dumont.¹⁶¹

Empire, second only to Idaho Springs in intensity and quality of its mining operations, enjoyed growth between 1890 and 1910. Because of improved milling methods, interest among capitalists, and local expertise, production increased 100 percent between 1897 and 1899. Although prospectors returned to the mountainsides and outfits started a number of small mines, the historic properties received the most attention. They were the subject of buyouts, consolidation, and improvements, many involving the Peck family.

After the late 1860s bust, the Pecks purchased Empire's principal mines when put up for sale, gradually assembling a substantial roster. They worked the Atlantic, Dunderberg, Equator, Gold Dirt, and Silver Mountain intermittently through the 1880s, but Frank Peck gradually lost interest and leased the properties out the next decade. By the late 1890s, Lafayette Hanchett, who managed the Lamartine Mine at Lamartine, leased the Dunderberg and Gold Dirt through the

¹⁵⁸ *Colorado Mining Directory*, 1898:125; "Mining News" *Mining Reporter* (4/12/1900): 220; "Mining News" *Mining Reporter* (2/21/01): 118; "Mining News" *Mining Reporter* (7/21/04): 68.

¹⁵⁹ *Colorado Mining Directory*, 1898:146; "Mining News" *Mining Reporter* (11/17/98): 17; "Mining News" *Mining Reporter* (1/18/1900): 39.

¹⁶⁰ *Colorado Mining Directory*, 1901:47; "Mining News" *Mining Reporter* (1/18/1900): 39; "Mining News" *Mining Reporter* (12/11/02): 492; "Mining News" *Mining Reporter* (1/1/03): 16; "Mining News" *Mining Reporter* (3/10/04): 251.

¹⁶¹ *Colorado Business Directory*, 1898:524; *Colorado Business Directory*, 1901:597; *Colorado Mining Directory*, 1898:145.

Corncracker Mining Company. The Silver Mountain Gold Mining Company leased the Silver Mountain mine and Clear Creek Mill at Empire Station.¹⁶²

In 1900, Frank Peck retired and disposed of the family mines, beginning a series of transactions and consolidations important to Empire. He sold the Atlantic to the Vermont stenographers noted above, who did well with the property. Peck sold the Dunderburg, Equator, Gold Dirt, and Peck Placer as a group to the Hartford Mining Company. These properties figured prominently in a tunnel project that company directors A.H. Woodbridge and John A. Amendt began during the late 1890s. At that time, they organized the Empress Mining & Tunnel Company and purchased the idle Aorta Tunnel near Empire (see Illustration A 1.2.24). The Bay State Mining Company began the tunnel during the 1860s, undercutting the rich Tenth Legion Vein and producing intermittently through the 1880s. Woodbridge and Amendt renamed the tunnel Empress, resumed work on the Tenth Legion, and began extending the tunnel to the Gold Dirt and other principal veins on Silver Mountain. Following the strategy of other tunnel projects, the directors planned to lease out rights-of-way to the Pecks and other claim owners to extract ore. Instead of leasing a right-of-way, however, the Pecks offered the Gold Dirt and the other mines to Woodbridge and Amendt. They reorganized as the Hartford Mining Company in 1901 to complete the deal and now had even greater incentive to push the tunnel. The Hartford company cancelled leases other parties held on the Gold Dirt, Dunderburg, and Equator, working these mines itself in 1902.¹⁶³

Meanwhile, the Empire Tunnel Company was boring into the base of Covode Mountain, a short distance south of the town. Frank A. Maxwell, Frederick P. Dewey, and J.M. Copeland organized the company in 1900 to develop the Paymaster and other veins. Maxwell was a Silver Plume mining engineer who helped build the Georgetown Loop on the Georgetown, Breckenridge & Leadville Railroad. Dewey was an investor in Georgetown, owned several mines, and organized the United Light & Power Company in 1893. The firm drove the Empire Tunnel to a length of 3,000' by 1903 but stalled. When the Hartford company became overextended, it sold the prized Gold Dirt and Empress Tunnel to the Empire Tunnel Company, which now owned considerable acreage. The company worked all three properties, struck a section of the Gold Dirt Vein, and extracted yet more ore. But this was insufficient to pay a heavy debt load, and the company collapsed like its Hartford predecessor.¹⁶⁴

The Silver Mountain Mine was one of the Peck properties that remained reliable and under constant ownership. When the Pecks sold in 1900, they offered the Silver Mountain and the Clear Creek Mill to lessee Silver Mountain Gold Mining Company. Manager M.B. Stewart kept the mine in heavy production and solicited custom business at the mill to increase income. When the Hartford company pushed the Empress Tunnel toward the mine, Stewart subscribed to the project as an investment. He even began a shaft to intersect the tunnel, but the project stalled when the tunnel became tangled in the chain of failed companies. Stewart was careful not to overextend his operation, carefully maintaining profitability and running the mill as a custom facility for additional income.¹⁶⁵

Despite company failures, the revival benefitted the town of Empire. The population grew nearly fifty percent from 500 in 1898 to 700 by 1901, the number of businesses increasing in parallel. The Denton Brothers and Lenninger & Barth sold groceries, hardware, and miners' supplies. Anderson & Swanson kept a dry goods and clothing store and liquor outlet. William

¹⁶² Harrison, 1964:386; *Colorado Mining Directory*, 1898:126, 128.

¹⁶³ Dillenback, Jackson D. *Facts about Empire*. Denver, CO: The William Haffner Engraving Co., [circa 1898], 8; *Colorado Mining Directory*, 1901:40; Harrison, 1964:387; "Mining News" *Mining Reporter* (5/9/01): 308.

¹⁶⁴ Harrison, 1964:382, 402; "Mining News" *Mining Reporter* (2/14/01): 102; "Mining News" *Mining Reporter* (2/5/03): 132.

¹⁶⁵ *Colorado Mining Directory*, 1901:48; Harrison, 1964:380; *Report of the Director of the Mint*, 1903:127.

Blamey had a second liquor outlet, and George Van Antwerp maintained a combination post office and stationary store. Guests stayed in the Peck House or the Cottage Hotel, and drank in the Christenson or Cook saloons. W.R. Collins provided healthcare, J.W. Cline ran the drugstore, and Charles Carpenter ran a barber shop. Trades were well represented by carpenters, contractors, blacksmiths, and an electrician.¹⁶⁶

Residents and businesses erected a small number of new buildings, and community organizers instituted modern services. Frank Peck introduced electricity in 1900, and it was gradually adopted. His power plant consisted of several dynamos turned by a gasoline engine and waterwheel originally used for an early mill. In 1901, the Empire Power & Light Company took over and increased capacity, while town fathers allocated money to improve the water system by replacing redwood pipes. In 1901, the *Empire True Fissure*, Empire's first newspaper, went into print under editor Dean Burgess. He was an undependable alcoholic, however, and shortly abandoned the project. Empire also received its first jail, reflecting an increase in crime brought by the industrial workforce.¹⁶⁷

After the 1902 peak, mining in the eastern drainage contracted before stabilizing. Between 1905 and 1910, gold output varied slightly between \$502,000 in 1905 and \$656,000 in 1908. A sudden burst of production accounted for the 1902 surge, but when the small outfits exhausted their limited ore deposits, output settled at the lower figure. The contraction was a symptom of maturation as large outfits had the capital, infrastructure, and technology required to profit from the complex, low-grade ore that remained.

On Seaton Mountain and at Spanish Bar, the principal mines remained largely the same, although the owners leased some out. As discussed above with the Griffith district, companies leased their properties when the richest ore was gone and a mine's best days appeared over. The Producer Mining Company leased the Franklin and Silver Age mines on Seaton Mountain beginning in 1906, and local mine owner R.C. Bonney organized the Sol Luna Mining Company to assume the Sun & Moon two years later. These mines maintained a place among the area's top ten, despite lack of confidence among their parent companies. The Consolidated Gem Mining Company under W.E. Renshaw continued deep development and claim acquisition. As designed, the Newhouse Tunnel served as a haulageway and platform for deep development among Seaton Mountain mines. All principal operations sent ore out the tunnel instead of hoisting material up to the surface through long shafts. The practice greatly reduced operating costs, allowing companies to extract lower grades of ore than before. Mining companies such as Consolidated Gem developed more sections of their veins, increasing ore reserves for long-term production. In response to the need for services underground, the tunnel company installed additional machinery at great cost, such as a massive air compressor and electrical circuitry.¹⁶⁸

The strong interest in deep tunnel projects calmed between 1905 and 1910, another symptom of a maturing industry. Investors abandoned ill-conceived and speculative ventures, which remained unfinished. Meanwhile, in 1906, miners added twenty miles of deep tunnels to the 100 miles already existing in the drainage. The Big Five company's tunnel at Seaton Mountain ultimately penetrated the target Bellman Vein in 1910. The Shafter Mining Company finished its Big Four Tunnel at Spanish Bar in 1906 and increased production, and R.C. Vidler's Luciana Tunnel finally struck several veins underneath Bellevue Mountain in 1909.¹⁶⁹

¹⁶⁶ *Colorado Business Directory*, 1898:433; *Colorado Business Directory*, 1901:505; Dillenbach, ca. 1898:6.

¹⁶⁷ *Colorado Business Directory*, 1901:506; Harrison, 1964:361, 368, 376, 391.

¹⁶⁸ *Mineral Resources of the United States*. Washington, D.C.: U.S. Geological Survey, Government Printing Office, 1907, 250; "Mining News" *Mining Reporter* (9/20/06): 294; "Mining News" *Mining Reporter* (2/6/08): 153.

¹⁶⁹ "Current News" *Mining Science* (4/29/09): 336; "Current News" *Mining Science* (11/17/10): 479; *Mineral Resources of the United States*, 1906:211; "Mining News" *Mining Reporter* (1/4/06): 15.

The contraction in mining and decrease in ore production throughout the eastern drainage between 1905 and 1910 forced approximately forty percent of the mills in Idaho Springs to close. The number decreased from more than twenty in 1902 down to approximately twelve by 1906. Although such a figure seems significant, most mills that closed were small, old, and inefficient. Their ancient equipment was not suited to the grades and types of ore, losing considerable proportions of the gold content. In addition, mill capacities were too limited to treat ore in economic volumes.

The well-established and proven mills, by contrast, remained in business. Nearly half, including the Allen, Bertha, and Jackson, relied exclusively on custom business from independent mining outfits. The Newton Annex Mill, originally built in 1904 to treat tailings from the Newton Mill, was the largest and most advanced of the custom plants. The rest were either owned or leased by mining companies that treated their own ore and accepted some custom business when convenient. Following this pattern, the Shafter Mining Company leased the Hudson Mill, the Consolidated Gem company the Newton at the Newhouse Tunnel, and the Tawassa Gold Mining & Milling Company the Idaho. Several milling companies refitted their facilities when it became obvious that the old processes and equipment were ineffective. George S. Wilkie, for example, installed a cyanide process in the Wilkie Mill in 1906 to treat mid-grade ore. He was among the earliest metallurgists to employ the process with success in the drainage, gaining a competitive advantage. Metallurgists subsequently tried cyanidation in the Newton and Black Eagle mills but met with failure.¹⁷⁰

Mining around Lawson followed the trend in effect elsewhere in the drainage between 1905 and 1910. The principal mines were the foundation of the local industry, and small operations few. Companies worked groups of claims through deep tunnels, produced large tonnages of ore, and ran mills on a combination of in-house and custom ore. Most operations were leases, but several were still worked by their owners. Charles Lawson and associates had the Joe Reynolds Mine in production through the Princess of India Tunnel, completed in 1900. The outfit treated considerable tonnage in its mill during the next decade. Roscoe B. Morton leased the Red Elephant Group from A.E. Reynolds in 1906 and focused his activity at the Commodore Tunnel. Based on experience as superintendent in the Tropic and other mines, he employed a strategy of reinvesting profits in development for long-term production. Miners lengthened the tunnel as money became available, granting access to more veins. The Red Elephant Mining Company pursued a similar course with the Red Elephant Tunnel, finished in 1910. The John A. Holmburg Mining & Milling Company bought the Bellevue-Hudson in 1907, reopened the main workings, and erected a new mill capable of treating the complex ore. The company did well for several years before selling the mine.¹⁷¹

Empire and Dumont went directly into decline between 1905 and 1910, as most veins were exhausted after forty years of production. Only two mines of substance, the reliable Albro and Pioneer, supported Dumont during the time. The small mines around Empire closed, followed by many substantial properties. The Conqueror, Gold Bug, Gold Dirt, Mint, and Neath became the principal producers, yielding only intermittently. Empire's population contracted, decreasing from 700 people in 1902 to 150 by 1908. Many businesses left, and electrical service was cancelled.¹⁷²

Despite the decline, Empire saw several new ventures. In 1909, a firm began driving the Marshall-Russell Tunnel northward from Empire Junction as a deep haulageway and drain for

¹⁷⁰ "Custom Milling Plants at Idaho Springs, Colorado." *Mining Reporter* (6/28/06): 636.

¹⁷¹ "Current News" *Mining Science* (10/29/08): 356; "Current News" *Mining Science* (3/3/10): 211; *Mineral Resources of the United States*, 1906:211; "Mining News" *Mining Reporter* (9/27/06): 319; "Mining News" *Mining Reporter* (1/24/07): 100.

¹⁷² *Colorado Business Directory*, 1908:654.

the principal mines in the Union district. Miners lengthened it to 3,300', struck the Neath Vein, and began extracting ore. The New System Mining Company, organized in 1910, backed Empire's other significant venture, purchasing the Mint Mine on Covode Mountain and erecting a new mill.¹⁷³

The period of maturity continued in the eastern drainage during the first half of the 1910s. Gold production varied slightly from a low \$446,000 in 1912 to a high of \$527,000 in 1915. Although the figures were similar to previous years, mining outfits worked harder, extracting greater tonnages of increasingly complex ore and investing further in mills for the same yield. These factors indicated that the eastern drainage had little rich ore left and was even running out of low-grade material. The large-scale operations, mechanization, and efficiency accelerated the trend in their heavy extraction.¹⁷⁴

Idaho Springs had the same principal operations during the period. The Newhouse Tunnel finally its full potential as a haulageway and deep development platform in 1910. A workforce of 150 to 200 miners used the tunnel to access approximately twelve veins underneath Seaton Mountain. In addition, Central City's mining companies sent ore out the five-mile bore to the Newton and Newton Annex mills. The Gem Mine was still producing, although W.E. Renshaw lost confidence in the property. He sold to the Idaho Mining, Reduction & Transportation Company in 1911 and moved on to the Crown Point & Virginia Mine.¹⁷⁵

The industry local to Spanish Bar underwent several adjustments, where decline of some mines balanced increased activity at others. Daniels and his Big Five company leased the Big Four Tunnel from the Shafter Mining Company in 1911 and still operated the Big Five Tunnel. Vidler continued pushing the Luciana Tunnel into Bellevue Mountain and reached another set of veins in 1911. Countering these operations, the Stanley slowed and assumed a minor role while the Quito Mining Company went bankrupt and lost its property at auction.¹⁷⁶

The mining industry around Lawson remained fairly stable. The handful of principal companies supported a population of 200 in the town as well as a hotel, mercantile, and saloon. Neighboring Dumont enjoyed the first increase in activity in more than five years. Investors reopened the Lee Mine on Albro Hill and built the McKelvie Mill in 1911. These and other mines maintained a population of 100 that patronized a basic set of businesses.¹⁷⁷

Like Dumont, Empire saw a minor revival. In 1910, G.D. Parks & Associates reopened the idle Atlantic Mine, leasing the Clear Creek Mill at Empire Station to treat ore. The following year, the Golden Empire Mining Company drove the Arvada Tunnel to undercut the Denver City, Golden, and Brighton lodes on Covode Mountain. The Duluth & Empire Mining Company pushed the Duluth Tunnel at the same time. Both companies began production within a few years. Empire also participated in one of the last gold excitements in Clear Creek drainage. While working an abandoned placer claim on Bard Creek west of town in 1910, James Beshear unearthed a substantial vein. Prospectors rushed to the area in search of more deposits, and although they found little of worth, the event created a sense of optimism.¹⁷⁸

¹⁷³ "Current News" *Mining Science* (9/16/09): 258; "Current News" *Mining Science* (5/12/10): 450; *Mineral Resources of the United States*, 1910:406.

¹⁷⁴ Henderson, 1926:109.

¹⁷⁵ "Current News" *Mining Science* (8/17/11): 164; "Current News" *Mining Science* (2/9/11): 168; "The Lower Clear Creek Mining District" *Mining Science* (5/11/11): 495.

¹⁷⁶ "Current News" *Mining Science* (2/2/11): 143; "Current News" *Mining Science* (9/28/11): 307; *Mineral Resources of the United States*, 1911:537.

¹⁷⁷ *Colorado Business Directory*, 1910:901; *Colorado Business Directory*, 1912:582; "Current News" *Mining Science* (3/2/11): 247; "Current News" *Mining Science* (9/7/11): 235.

¹⁷⁸ "Current News" *Mining Science* (5/4/11): 480; Harrison, 1964:407, 411, 413.

The principal companies around Empire still generated ore, contributing to the community's stability. The Conqueror Mining & Milling Company erected a new mill at North Empire in 1911, while the New System Gold Mining Company finished its mill and operated the Mint Mine. Miners bored the Marshall-Russell Tunnel to a length of 5,000' by 1911 and brought several veins into production.¹⁷⁹

The optimism at Empire, as well as elsewhere in the eastern drainage, was short-lived, however. The mining industry and associated communities had grown comfortable with their relatively constant output, but a combination of factors brought this to an end in 1916. Gold production quickly decreased from \$429,000 down to \$231,000 in 1918. World War I burdened the economy and increased costs of needed materials. By 1916, the United States mobilized in support of the Allies, dedicating industrial capacity, labor, and ultimately armed forces to the conflict. Operating costs rose, labor became scarce, and many industrial materials were no longer available. Clear Creek mining companies almost simultaneously ran out of profitable grades of ore, as well. Conditions worsened as the war progressed, forcing most companies to shutter mines, and although Armistice brought relief to Europe in 1918, it had minimal impact on Clear Creek's gold industry. More companies went out of business, and by 1920, the industry yielded a meager \$49,000 and was no longer viable. The eastern drainage entered a depression lasting more than ten years.

Gradual Decline in the Western Drainage, 1898-1907

Between 1898 and 1907, Colorado entered one of its most productive periods of mining. The economy recovered from the post-Silver Crash depression, and investors were willing to risk capital. Technology and improved mining methods reduced operating costs, while better milling practices rendered previously uneconomical grades of ore profitable to produce. Although the value of silver remained low at around \$.60 per ounce, these conditions fostered a major statewide mining revival. Many silver districts returned to life after five years of abandonment and entered peak production. Gold mining also boomed and, as discussed above, eastern Clear Creek drainage enjoyed unprecedented growth and prosperity. Meanwhile, the western drainage did not comparably benefit. Production of silver and industrial metals rose briefly and almost imperceptibly during the late 1890s before resuming its gradual decline, instead of increasing as in other silver districts. Companies generated \$870,000 in silver and \$189,000 worth of lead in 1897, peaking at \$926,000 in silver and \$222,000 worth of lead the following year. By 1901, the figures slipped to \$763,000 in silver and \$167,000 in lead and continued ebbing.¹⁸⁰

The western drainage still suffered the effects of the Silver Crash. When the industry temporarily stopped in 1894, experienced miners and professionals left, businesses closed, and investors chilled toward Clear Creek silver mines. Although the industry returned to work by 1895, it faced another intractable problem: high-grade ore was gone and exploration projects found few new ore formations. This left companies with known and proven veins, and although these had not yet been fully developed, much of the ore was low in grade. Profiting from such payrock required efficiency and production in high tonnages to offset silver's low value, conditions favoring large companies. Because small outfits were unable to subsist on available low-grade ore, they were relatively few and contributed little production. Large companies, in contrast, mechanized, consolidated ore-bearing ground, and produced payrock in economies of scale. These companies were the foundation of the industry from the late 1890s on.

¹⁷⁹ "Current News" *Mining Science* (3/9/11): 273; "Current News" *Mining Science* (9/28/11): 307; Harrison, 1964:41.

¹⁸⁰ Henderson, 1926:109.

In some cases, old mines that saw little systematic development in the past provided a new opportunity for local investors. They organized a tier of mid-level companies that either purchased or leased old mines, employing some mechanization and systematically developing veins at depth. Although such mines had been stripped of high-grade ore, the remaining payrock was pure enough to support limited operations. Large well-capitalized companies were responsible for most activity, with long-standing organizations extracting ore from the proven properties. On Democrat Mountain, the Good Luck Mining & Milling Company, organized by Denver investors in 1880, produced from the Little Emma. Ernest Le Neve Foster ran the Matilda Fletcher after twenty years of intermittent work. Feuding parties owning sections of the various veins on Leavenworth Mountain sorted out their differences to reopen one of Georgetown's largest mines. Previously, the Colorado Central Consolidated Mining Company owned most of the Colorado Central Vein, but the Silver Crash forced bankruptcy. Powerful New York investor Solomon Turck bought the complex at foreclosure in 1895 but made little progress after litigation froze operations. Rather than allow the properties to remain idle, Turck and other owners came together as the Aliunda Consolidated Mining Company in 1898, resuming production through the Marshall Tunnel.¹⁸¹

Companies continued pulling low-grade ore out of principal mines at Silver Plume, as well. On Republican, the Hermann Mining Company still worked the Dunkirk, Jacob Fillius kept the Baltimore Tunnel in production, and the Pay Rock Consolidated Mining Company ran the Pay Rock Mine. All three outfits predated 1885. Others included the Cashier Silver Mining Company and Robert Old's Mendota and Captain Wells, collectively the strongest operations on Sherman Mountain. The Pelican-Dives, Dunderberg, and Terrible mines were three producers troubled by the Silver Crash. British-based Colorado Silver Mines, Ltd originally ran the Terrible Mine and Mill at Brownville, which investors reorganized as the New Colorado Mining Company to avoid bankruptcy. The New Dunderberg Mining Company, from similar origins, employed a large crew of seventy-five miners on Sherman Mountain. The Pelican-Dives Mining Company was the largest operation with 150 to 200 miners busy in the Pelican, Dives, and Seven-Thirty.¹⁸²

These and other large companies were responsible for the minor rise of metals production during the late 1890s, reinvigorating the industry after several years. Both local and distant investors funded surface work, installed machinery, pushed underground exploration and development, and erected new mills. Of the trend, Denver-based *Mining Reporter* observed:

The most encouraging feature of the present conditions is the large amount of new capital that has taken an interest in the district and started work on various propositions that will be of great benefit to the future of the camp. There is undoubtedly more systematic development in progress now than there has been for several years, and it is projected on a scale which should double the production of the camp as soon as the objective points are reached.¹⁸³

Frederick Dewey and other community figures invested capital in United Light & Power Company, one of the most important projects in the western drainage. Since inception in 1893, the company generated Direct Current (DC) at its Georgetown power plant, like most early electric providers. Because DC current could not be transmitted far, service was restricted to Georgetown and immediate mines. Alternating Current (AC) could be transmitted much farther, but early AC motors were unable to meet the needs of mining. Thus, although electricity had

¹⁸¹ Callbreath, 1899; *Colorado Mining Directory*, 1898:131; "Mining News" *Mining Reporter* (9/21/98): 18.

¹⁸² *Colorado Mining Directory*, 1898:131, 134.

¹⁸³ "Clear Creek County" *Mining Reporter* (1/9/02): 42.

great potential to lower operating costs, most of the Griffith district continued relying on steam and waterpower. Electrical engineers solved the problems of AC motors and circuits by the late 1890s, and the technology was ready for mining. In 1899, United Light & Power began wiring an extensive AC grid to both earn profits for the company and improve conditions. The company extended three-phase AC lines west to Silver Plume and east to Lamartine and built a new AC hydropower plant at Georgetown. Electricity for lighting and running machinery effectively lowered operating costs for many companies at a time when this was needed.

In the positive climate, many companies improved their operations and developed known veins at depth, yielding results. The owners of the Centennial Mine on Leavenworth Mountain deepened their shaft to 600', installed a costly air compressor, and enjoyed heavy production through 1901. Around the same time, local mine owners William B. Hood and Frank Maxwell organized the Lynn Consolidated Mining Company, purchasing the Mineral Chief Mine in 1902, boring the Moline Tunnel into its lower workings, and sending ore to their Georgetown mill.¹⁸⁴

Democrat Mountain was among the few silver-bearing landforms in the district not yet developed at depth with long tunnels. Although investors recognized this fact, few were willing to bear the enormous cost of a major tunnel project. In 1900, B.F. Kelly began work on the new Kelly Tunnel through the Georgetown Deep Mining & Tunnel Company. Kelly had a checkered history promoting similar schemes elsewhere in Colorado, some successful but most not. In 1893, for example, he, Charles Nelson, and others bored the Nelson Tunnel along the famed Amethyst Vein in the Creede Mining District, linking its principal mines and improving production. Kelly began Oro Tunnel four years later, to be a four-mile passage underneath the Las Animas Mining District near Silverton. Kelly ran the company into debt without much progress, left it in the hands of bewildered investors, and became known in Silverton as "Tunnel Kelly" for the fraud. He also promoted the Creede & Gunnison Short Line Railroad to grade a line from Creede to Gunnison, obtained financing, but allowed the scheme to collapse with nothing to show.

Shortly after organizing the Georgetown Deep company, Kelly promoted the new tunnel in the local press, the *Mining Reporter* noting in 1901:

The Georgetown Deep Mining, Tunnel & Transportation Company has now underway one of the largest enterprises of Georgetown. The tunnel is more familiarly known as the 'Kelley Tunnel.' The tunnel runs from the foot of Republican mountain in a northerly direction, and is projected to run 9,900 feet. In its course, it will cut forty-two known veins, and of these, the company owns thirty-three, and with working privileges on the others. In addition to these known veins it is believed the tunnel will cut a large number of blind veins.¹⁸⁵

Kelly intended for the costly Democrat Mountain project to serve several needs. At the very least, the operation could support his lavish lifestyle, as had Silverton's Oro Tunnel. At best, it might actually prove to be an economic success like the Nelson Tunnel. Ultimately, the Kelly Tunnel fulfilled both goals. Within two years, miners drove the tunnel approximately 1,300' and penetrated the Great Western and Jessie M. veins at depth, yielding rich ore. Miners struck yet more veins within a short time, but not the forty-two suggested by the press. In a pattern common among mining scheme promoters, Kelly failed to keep the company solvent, and the Democrat Mountain Mining, Milling & Transportation Company took over the tunnel in 1904.¹⁸⁶

¹⁸⁴ "Mining News" *Mining Reporter* (2/28/01): 135; "Mining News" *Mining Reporter* (3/20/02): 298; "Mining News" *Mining Reporter* (7/11/01): 27.

¹⁸⁵ "Mining News" *Mining Reporter* (12/12/01): 478.

¹⁸⁶ "Mining News" *Mining Reporter* (2/14/01): 102; "Mining News" *Mining Reporter* (11/21/01): 410; "Mining News" *Mining Reporter* (10/16/02): 316; "Mining News" *Mining Reporter* (12/25/02): 534; "Mining News" *Mining Reporter* (6/9/04): 690.

Other schemes collapsed because of poor planning. In 1901, the Red Oak Mining & Milling Company bought the Astor Mine, one of the oldest producers on Democrat Mountain. Excited, investors funded a new mill on the valley floor and an aerial tramway to carry ore down from the mine. They made the fatal error, however, of building without first confirming sufficient ore reserves. When the operation approached insolvency within the year, its investors sued each other instead of directing monies toward underground development. Before the company could sort out its problems, the mill burned in a mysterious fire, ending the enterprise.¹⁸⁷

Despite the above failures, most companies were legitimate and generated enough ore to support local milling. As in the eastern drainage, old mills were either refitted or replaced with new plants, and metallurgists did well with sampling facilities. The Chamberlain & Dillingham Ore Company, organized in 1902 by W.J. Chamberlain and Frank Dillingham, became the most successful sampler outfit. Both millmen began their careers in Georgetown during the mid-1870s. Dillingham worked in the Mathews, Morris & Company mill in 1876 and married Kate, daughter of W.G. Chamberlain. They moved to Silver Cliff where Dillingham opened his own sampler in 1878, formed a partnership with W.J. Chamberlain during the 1880s, and built additional samplers in Denver and Boulder. The partners further expanded into Georgetown, Black Hawk, Breckenridge, and Idaho Springs in 1902.¹⁸⁸

At the same time, Chauncy E. Dewey built the Dewey & Wheeler sampler. Dewey had a background similar to Dillingham, but arrived in Georgetown during the early 1880s. He opened the Dewey Sampler in 1885, moved to Hinsdale County for several years to erect the Hidden Treasure Mill, and returned in 1891. Dewey bought the idle Clear Creek Mill at Georgetown, running it as a custom plant and converting that facility into the Dewey & Wheeler sampler. In 1905, the Anglo-Saxon Mining & Development Company erected another mill both to treat its own ore and also custom payrock. The company installed what may have been the first cyanidation process in the western drainage, suggesting that the mill specialized in ore with a high gold content.¹⁸⁹

Heavy ore production continued at Silver Plume in the first years after 1900. Companies, however, engaged in fewer improvement projects than at Georgetown because they had already invested in efficiencies during the post-Silver Crash depression. An advanced and high-capacity mill at the Mendota Mine was among these. Owner Robert Old prepared to retire during the late 1890s, disposing of his numerous mines, including the Mendota. Before he sold, Old hired engineer Frank A. Maxwell to erect the new mill. Maxwell dismantled the Rocky Mountain Mill at Georgetown and the Terrible Mill at Silver Plume, combining structural elements and machinery into the Mendota facility, known as the Maxwell Mill. The plant began treating low-grade ore in 1899, providing a service essential to the local mining industry. Old then sold the Mendota in 1900, when new owners began major development.¹⁹⁰

The Pelican-Dives Mining Company was among the most aggressive firms seeking out new ore formations. The company, Silver Plume's largest employer and producer, resumed driving the Burleigh Tunnel in 1902 to penetrate the lower reaches of several veins not yet fully

¹⁸⁷ "Mining News" *Mining Reporter* (3/28/01): 236; "Mining News" *Mining Reporter* (7/25/01): 64; "Mining News" *Mining Reporter* (1/30/02): 144.

¹⁸⁸ Smiley, Jerome C. *Semi-Centennial History of the State of Colorado*. Chicago, IL: Lewis Publishing Co., 191, 393; "Mining News" *Mining Reporter* (4/10/02): 367.

¹⁸⁹ "Mining News" *Mining Reporter* (4/3/02): 343; "Mining News" *Mining Reporter* (8/31/05): 218.

¹⁹⁰ *Georgetown Courier* (4/12/30): p1 c6; *Report of the Director of the Mint*, 1900:116.

developed. The property changed hands for a huge sum in 1904, and the new Dives-Pelican & Seven-Thirty Mining Company successfully found enough ore to justify a new mill in 1905.¹⁹¹

The Argentine Mining District was one of the few areas in the western drainage that fit the statewide pattern of revival and boom at the turn of the century. Except for the Stevens and Baker mines, Argentine went largely quiet in the mid-1880s. When companies stopped work, they left low-grade ore reserves in place because of high operation costs and declining silver values. Some properties also still featured pockets of rich payrock. A rare discovery drew attention to the district, and a few investors grew curious about this remaining ore in the now-vacant properties. Charles Carlson, who had a long history with the district, was prospecting McClellan Mountain in 1898 and found a vein he named the Santiago. He already possessed a number of claims requiring attention and therefore offered the unproven formation to fellow prospector William Rogers. With relatively little work, Rogers found the vein to be a bonanza somehow missed during previous decades. Rogers quit his position as superintendent of the Wilcox Tunnel near Idaho Springs to devote his attention to the mine. Reinvesting some profit, Rogers quickly developed the Santiago into a noteworthy producer.¹⁹²

Jacob Fillius, B.B. Lawrence, Henry Seifried, and C.K. Wolfe were among the first experienced operators to take a serious interest in the Argentine district following the new discovery. They bought the Stevens Mine from the British-based Mount McClellan Mining Company, Ltd when the firm lost confidence in 1899. Fillius and partners organized the Stevens Mining & Milling Company, hiring Jacob H. Robeson as manager based on his experience as superintendent of the Pelican-Dives. Understanding how to profit from low-grade ore, Robeson minimized expenses and extracted with great efficiency.¹⁹³

Edward J. Wilcox and R.C. Vidler, two wealthy mine operators in the eastern drainage, were next to take an interest in the Argentine district. Wilcox was president and manager of the Miami Mining & Tunneling Company, employing Rogers as superintendent of the Wilcox Tunnel. Wilcox learned of the Santiago from Rogers, joined forces with Vidler, and devised a strategy for systematically exploiting the Argentine district. Convinced that ore still lay underneath McClellan Mountain, he organized the Waldorf Mining & Milling Company in 1901 and purchased the Huckleberry, Independence, Wheeling, and undeveloped property on the eastern side. Wilcox then purchased the Stevens Mine at a high price from Fillius and partners to secure the mountain's western side. Wilcox commissioned the Wilcox Tunnel, also known as the Argentine, driving it from the old townsite northwest toward the Santiago. Miners struck the Paymaster Vein in 1902, confirming suspicions that profitable grades of ore still existed at depth. Wilcox also ran the Stevens for immediate income, erecting a new mill there in 1903.¹⁹⁴

While Wilcox worked his properties, Vidler began the Vidler Tunnel, his third such venture in the county. But because the project was not founded on known ore reserves, he had difficulty securing investors. Broadening the project's appeal, Vidler promoted it as a combination mining and railroad tunnel through the Continental Divide. He claimed that a railroad tunnel would be profitable in itself, with hidden ore formations contributing significant income. Sited near Wilcox's operation, the tunnel was projected directly underneath Argentine Pass and opening into Peru Creek, Summit County. Vidler organized the Transcontinental Transportation & Mining Company and began work in 1901 or 1902.¹⁹⁵

¹⁹¹ "Current News" *Mining Science* (3/14/12): 260; "Mining News" *Mining Reporter* (5/21/03): 475.

¹⁹² *Georgetown Courier* (2/26/27): p1 c6.

¹⁹³ Ellis and Ellis, 1983:112.

¹⁹⁴ "Mining News" *Mining Reporter* (5/16/01): 325; "Mining News" *Mining Reporter* (11/7/01): 368; "Mining News" *Mining Reporter* (6/19/02): 582; "Mining News" *Mining Reporter* (11/5/03): 442.

¹⁹⁵ "Mining News" *Mining Reporter* (6/19/02): 582; "Mining News" *Mining Reporter* (9/17/03): 265.

Despite the limited Argentine revival and investment and improvement projects elsewhere, metals production declined significantly in the western drainage after the late 1890s surge. Annual yield fell from \$842,000 in silver and \$220,000 worth of lead in 1900 to \$422,000 in silver and \$154,000 in lead by 1905. The western drainage saw its income halved within five years, which would have been even greater were it not for improvement projects and recent recovery of zinc. Until 1902, mining companies gave little thought to zinc as a profitable metal. Its market was limited, metallurgists considered zinc a nuisance for interfering with silver concentration, and had trouble recovering zinc as a product in itself. But by 1901, a strong market materialized, and metallurgists figured out how to recover zinc and began developing mill appliances accordingly. In the Griffith district, zinc was simple and easy to recover, and because of this, mining companies began producing small amounts as byproducts of lead production. Encouraged by the new market, supported with better technology, and pushed by waning silver ore reserves, the industry began a concerted effort in 1902. The following year saw a notable output of \$35,000, doubling by 1905, and afterward becoming important among the metals portfolio in the western drainage.¹⁹⁶

The industry responded in two ways to dwindling silver and lead reserves with zinc as a partial alternative. On one hand, many companies leased out their properties or otherwise cut costs on maintenance, improvements, and development. Infrastructure suffered as a result, and underground workings decayed to the point of no longer being viable. On the other hand, a few well-financed companies improved existing mills or built facilities anew to recover silver and lead more efficiently, and now zinc as well (see Illustration A 1.2.25).

In 1906, the Lynn Consolidated Mining Company and Anglo-Saxon Mining & Development Company improved extant mills at Georgetown, while the Aliunda Consolidated Mining Company and Griffith Mines Company erected new plants. B.F. Kelly's former tunnel was a surprising success, penetrating enough veins to support another new mill, erected by the Democrat Mountain Mining & Milling Company. William Rogers built the fourth new mill at Georgetown for his Santiago Mine in 1905. In Silver Plume, the Scotia Mines Company built the Scotia Mill to treat ore from the Antelope Tunnel, while the Jewel Mining, Milling & Leasing Company ran its new mill for the Frostburg and other Sherman Mountain mines. The owners of the Ward Mill refitted their Silver Plume plant with the second cyanidation process in the western drainage.¹⁹⁷

Defying the regional decline, the Argentine district was abuzz with four major operations and numerous small ventures (see Illustration A 1.2.26). The East Argentine Tunnel Company imitated Wilcox, purchasing several formerly productive mines on McClellan Mountain and starting a tunnel in 1905. The next year, miners struck a substantial vein in the Vidler Tunnel and erected a mill. William Roger's Santiago Consolidated Mining, Milling & Tunnel Company and Edward Wilcox's Waldorf Mining & Milling Company were by far the most productive. Shortly after Wilcox organized the Waldorf company, he and Rogers coordinated their operations. Wilcox hired Rogers as superintendent, and Rogers continued pushing the Wilcox Tunnel and amassing property in the central district on behalf of the company. Wilcox designed the tunnel to undercut the Santiago at depth, which Rogers otherwise may not have been able to afford.¹⁹⁸

The relationship culminated in 1905 when Wilcox began grading the Argentine Central Railroad into the district from Silver Plume. Wilcox built the railroad to fulfill two purposes. The

¹⁹⁶ Henderson, 1926:109.

¹⁹⁷ *Georgetown Courier* (1/13/06); *Georgetown Courier* (4/4/31): p1 c6; *Mineral Resources of the United States*, 1906:211; "Mining News" *Mining Reporter* (9/28/05): 320; "Mining News" *Mining Reporter* (7/26/06): 93; "Mining News" *Mining Reporter* (11/22/06): 525; "Mining News" *Mining Reporter* (12/6/06): 577; "Mining News" *Mining Reporter* (3/21/07): 276.

¹⁹⁸ *Mineral Resources of the United States*, 1905:197; "Mining News" *Mining Reporter* (11/15/06): 501.

most important was lowering the Waldorf company's operating costs by hauling in freight and exporting ore at rates far below wagon drayage. The other purpose was to provide service to the rest of the district, charge shipping fees, and recover construction costs. Rogers also saw the railroad benefitting the Santiago, so he supported the project. Wilcox aggressively pushed construction through winter, 1905, completing the line the next year. The Argentine Central was the first railroad built in Clear Creek County in more than twenty years and also highest in elevation nationally.

Wilcox and Rogers also undertook a new concentration mill at the tunnel in 1905. As with the railroad, Wilcox intended to serve the Waldorf company and Santiago first, and other mines secondarily. Rogers erected an aerial tramway to provide constant flow from the Santiago to the mill. The railroad, mill, and work underground supported a camp at the tunnel. To increase revenue and maximize use of railroad and camp, Wilcox actively solicited tourists attracted to the alpine environment. He added observation cars to the railroad, extended it farther up McClellan Mountain, and built a hotel and restaurant at the camp. Wilcox named the camp after himself, but the Post Office Department granted a post office under the alternative name of Waldorf in 1906.¹⁹⁹

Although production in the western drainage declined during the first years after 1900, the region entered a period of a low-level stability. In 1907, however, national economic cycles and four decades of ore extraction fouled the climate for mining. A recession struck toward the end of 1907, pushing the western drainage into its first sustained depression since the Silver Crash. Production for the year slipped to \$342,000 in silver and \$148,000 for lead. The industry, however, recovered a record \$164,000 in zinc, partially offsetting the decline. As the recession manifested fully in 1908, metals prices ebbed until silver averaged \$.56 per ounce, the worst value since the Silver Crash. At the same time, many companies exhausted profitable grades of ore and closed. The rest extracted payrock from greater depths, which was more expensive than before. Production thus fell in 1908 to \$267,000 in silver, \$85,000 for lead, and \$39,000 worth of zinc, hovering near these levels for years. The industry contracted around large companies with sufficient ore reserves and the infrastructure necessary to produce in economies of scale.²⁰⁰

The recession also negatively impacted communities already in decline. As with the Silver Crash, demand for labor, supplies, and services shrank when companies scaled back operations or suspended altogether. Interpreting statistics, approximately thirty percent of the western drainage's workers and businesses left for opportunities elsewhere. A total of 1,413 people lived in and around Georgetown and 775 about Silver Plume in 1900. By 1910, the population dropped to 950 in Georgetown and 460 in Silver Plume. The hamlet of Silver Dale, serving Leavenworth Mountain mines, was nearly abandoned by 1907, only ten families remaining afterward. The downward trends in industry, business, and population pushed the western drainage into prolonged depression, which lasted for years. Although the mining industry was dear to those residents who remained after 1907, it lost its wider influence.²⁰¹

The 1907 recession reversed the Argentine revival, ruining nearly all projects there. Vidler suspended his tunnel, while Wilcox's small empire collapsed under debt. Exacerbating this problem, Santiago ore became too complex for the Wilcox Mill, which closed when Rogers leased a better mill in Georgetown. Facing bankruptcy, Wilcox sold the Waldorf company to British investors who reorganized it as the Waldorf Metal Company. Prior to the recession, Wilcox refused an offer of \$3.5 million from another British group. The Waldorf property

¹⁹⁹ Bauer, et al., 1990:148; *Mineral Resources of the United States*, 1905:197; "Mining News" *Mining Reporter* (1/25/06): 92; "Mining News" *Mining Reporter* (11/15/06): 501.

²⁰⁰ Saxon, 1959:7, 8, 14, 16; Henderson, 1926:216.

²⁰¹ *Tailings, Tracks, & Tommyknockers*, 1986:46; Schulz, 1976:1910-10.

reverted to Wilcox in 1908 when the Waldorf Metal Company failed, but it sat idle because he had no operating capital. Wilcox tried subsisting on tourist traffic, but operating losses forced him to dispose of his share of the railroad in 1909.²⁰²

The World War I Revival in the Western Drainage, 1915-1920

The western drainage remained depressed between 1908 and 1914. Depending on the year, the industry consisted of between eleven and sixteen principal mines generating no more than \$300,000 per year. Georgetown had only a single, consistent mine to rely on. The Capital Mining Company reopened the Colorado Central in 1910 and maintained a steady but limited output. Otherwise, lessees worked various properties around Georgetown, opening some and closing others, extracting ore as they encountered it. Silver Plume was in a similar state. Lessees gleaned low-grade ore from old, reliable properties on a regular basis, but production was minor. Industry bellwether Dives-Pelican & Seven-Thirty Mining Company, the only organization of substance, went bankrupt in 1912.

And yet, individuals remaining in the western drainage during the early 1910s were optimistic that political unrest in Europe might revive the moribund industry. When World War I began in 1914, manufacturing industries mobilized in Europe and then the United States to meet heavy wartime demand. As war progressed and devastated Europe's economy, governments sought stability in silver. On a statewide level, the greater mining industry saw the value of industrial metals and silver slowly rise and shoot upward as the conflict dragged on. Silver ascended from an abysmal \$.54 per ounce to \$.73 and continued upward to \$.84 in 1916, a price not seen since 1893. Lead and zinc, which never fetched high values, almost doubled. Zinc, valued at \$.05 per pound in 1910, leaped to \$.08 by 1917, while lead doubled from \$.04 to \$.08 per pound. Ores profitable by 1910 standards became almost the stuff of bonanza, while impoverished ore, still in plentitude, was at last worth producing.²⁰³

The improved conditions ushered in a surge of activity across Colorado. Silver mining districts, many in states of depression similar to western Clear Creek, returned to prosperity. But the movement had less effect in the western drainage due to waning ore reserves. A few properties still featured disbursed stringers of mid-grade payrock limited in size, difficult to work, and extracted in minor lots by pairs of lessees. Many formerly productive mines had larger bodies of inferior ore suited for company operations. Past operators had also poured previously unprofitable grades of ore into underground stopes as fill or as surface waste rock. Known as mixed waste, the material became an important source of ore because it was plentiful and already fragmented into cobbles.

Mining companies and lessees produced all the above types of ore, contributing to a rise in annual output. In 1914, fifteen principal mines generated \$191,000 in silver, \$95,000 for lead, and \$54,000 worth of zinc. In 1917, figures climbed to a peak of twenty-two principal mines, \$434,000 in silver, \$416,000 for lead, and \$322,000 worth of zinc.²⁰⁴

Activity divided almost evenly between Georgetown and Silver Plume. The Onondago Mining Company was Georgetown's largest operation. Its workers extracted ore from the Capital Tunnel and sorted the waste rock dump at the Colorado Central Mine. The company was highly productive, treating some ore in Georgetown and shipping overflow to a mill at Idaho Springs. On Leavenworth Mountain, Colorado Mining Company workers dug through dumps at the

²⁰² Abbott, Dan. *Stairway to the Stars: Colorado's Argentine Central Railway*. Ft. Collins, CO: Centennial Publications, 1977, 3; *Mineral Resources of the United States*, 1907:249.

²⁰³ Henderson, 1926:216; King, 1977:183; Saxon, 1959:7-17.

²⁰⁴ Henderson, 1926:109; *Mineral Resources of the United States*, 1915:442; *Mineral Resources of the United States*, 1917:816.

Equator, Marshall, and Ocean Wave tunnels and recovered so much material that the company erected a new mill. The metallurgist installed state of the art flotation process equipment for separating silver and industrial metals from inferior ore.²⁰⁵

The Wasatch-Colorado Mining Company was Silver Plume's largest operation and accounted for a significant proportion of the region's production. Distant investors organized the firm in 1916 to consolidate the central portion of the Silver Plume area, starting with the Mendota and Frostberg mines. The company also acquired the Graham Mill because it not only concentrated silver and lead, but also included a separate process for zinc. In 1917, the directors either leased or bought the Diamond Tunnel, Pelican-Dives, Mammoth, Phoenix, and Seven-Thirty properties. In so doing, the Wasatch-Colorado company assumed a role as Silver Plume's economic cornerstone.²⁰⁶

Leasing companies reopened the principal mines in the Argentine district, contributing heavily to the western drainage's World War I output. Louise M. Rogers, wife of William, leased the Santiago in 1915 under the old firm of Santiago Consolidated Mining & Tunnel Company. Louise personally managed the operation in the absence of William, shipping ore by rail to a mill in Silver Plume. When another party leased the Wilcox Tunnel and refitted its mill with flotation in 1917, Louise sent ore there. The Argentine mines yielded \$112,000 in 1916 and nearly as much the following year.²⁰⁷

The World War I revival was short-lived and production declined one last time even though metals prices remained high. By the end of 1917, one outfit after another exhausted the last of its low-grade ore and suspended. In 1918, only ten principal mines remained open, producing \$371,000 in silver, \$275,000 of lead, and \$165,000 worth of zinc. Armistice at the end of 1918 worsened economic conditions, and, although the value of silver was high, demand for industrial metals fell as arms manufacturing slowed. In response, the western drainage yielded \$400,000 in silver, but only \$80,000 in lead, and \$44,000 worth of zinc during 1919. Postwar depression pushed the industry into ruin in 1920, with production collapsing to a fraction of the 1919 figures.²⁰⁸

Mining in the western drainage never recovered, but as long as underground workings offered ore even in minor pockets, some activity continued. Although mining was central to those people who stayed in the region after 1920, the broader industry was no longer viable. Between 1873 and 1893, it regularly produced more than \$1.5 million in silver, lead, and zinc per year. Output gradually fell, and from 1921 until the late 1960s, when nearly all activity ended, production rarely exceeded \$200,000. Despite its dissipation, mining's culture remained intact for much of this time, and elements of the industry remain clearly evident in the western drainage today.

Great Depression Revival in the Eastern Drainage, 1930-1942

Eastern Clear Creek drainage passed through the 1920s in a condition similar to the western drainage. The mining industry became unable to employ a substantial workforce or support area communities in 1918, and only a handful of mines produced a total of \$120,000 per year through the 1920s. A deep depression forced many people to leave, and those who stayed endured poverty and sought income from sources outside mining. The economy came to depend

²⁰⁵ *Mineral Resources of the United States*, 1916:351; *Mineral Resources of the United States*, 1917:816.

²⁰⁶ *Mineral Resources of the United States*, 1916:351; *Mineral Resources of the United States*, 1917:816.

²⁰⁷ *Mineral Resources of the United States*, 1916:350; *Mineral Resources of the United States*, 1917:815.

²⁰⁸ Henderson, 1926:109.

on tourism, the Colorado & Southern Railroad, and automobile traffic over Berthoud and Loveland passes.

In 1929, the depression widened nationally. The economy at first destabilized, with financial experts anticipating that market sectors were merely undergoing short-term adjustments. As bank security and stock values continued sliding downward, experts forecasted a national recession similar in scale to the one of 1907. Between September and November, however, financial panic pushed the nation into the Great Depression. Business and commerce imploded, tens of thousands were thrown out of work, capital necessary for industry evaporated, and many goods and services were curtailed or became unavailable. The economic climate worsened under President Herbert Hoover, bringing mining and other industries to a standstill. The prices for silver and industrial metals dropped to their lowest values in decades. Silver slid from around \$.60 to a mere \$.29 per ounce. At the same time, copper fell from more than \$.13 to \$.11 per pound, while lead decreased from at least \$.06 to \$.05 per pound.²⁰⁹

The Great Depression was unlike any bust that Clear Creek drainage had yet experienced. Although the drainage was in depression during the 1920s, the rest of the nation was not, and Clear Creek residents could hope for economic stimulus from the outside. The Great Depression confirmed that silver and industrial metals mining would not recover, undermining alternative sources of income, as well. Tourism nearly stopped and demand for freight or passenger service dropped to an all-time low. The Colorado & Southern drastically reduced its schedule and ran trains between Denver and Idaho Springs on Tuesdays and Fridays, and irregularly to Silver Plume.

The eastern drainage still possessed one resource little impacted by this climate. Because the federal Treasury based the dollar on a gold standard, the metal still fetched \$20.70 per ounce, despite the economic collapse. Unemployed miners and their families returned to idle gold producers to eke out a subsistence-level income, forming a cottage industry of sorts. A return to nearly forgotten labor-intensive practices was a hallmark of the movement because most individuals and partnerships were unable to afford machinery. Miners expected only to meet their simple needs, and most individuals were satisfied with several dollars' worth of metal per day. In addition to working underground, subsistence miners favored two other sources of gold requiring no investment beyond hand tools. Old placer mines offered just enough gold dust to provide an income, while waste rock dumps at shafts and tunnels featured low-grade ore cast off as unprofitable.

Cottage industry mining spread through the eastern drainage beginning in 1930. Although primitive, subsistence operations were a vital source of income as individuals, partnerships, and families generated a total of \$112,000 in gold, more than most years following 1922. The gold eventually interested investors, as well. One group reopened the West Gold Mine and refitted the associated mill with cyanidation to treat low-grade ore. Another party planned a large placer operation to work Clear Creek in economies of scale, leasing several miles of streambed from William Renshaw in 1932. But because relatively few investors had capital to spare, most mining was subsistence from 1930 through 1933.

When Franklin Delano Roosevelt was elected president in 1932, he instituted policy changes that made mining more attractive to investors. Roosevelt developed a plan simultaneously devaluing the dollar while stimulating metals mining on a broad scale. The Federal Reserve took the dollar off the gold standard in 1933 and bought gold at inflated prices. The plan worked well. The value of the dollar fell and gold mining began reviving as expected, proven by a gradual increase in the volume of gold flowing into the treasury. Satisfied with the

²⁰⁹ *Minerals Yearbook*. U.S. Department of the Interior, U.S. Government Printing Office, 1937, 115; Saxon, 1959:7-9, 14-17.

test, Roosevelt signed into law the 1934 Gold Reserve and Silver Purchase acts. The Gold Reserve Act raised the minimum price of gold from around \$20.67 to \$35 per ounce, while the Silver Purchase Act raised silver from around \$.40 to \$.70 per ounce.²¹⁰

Roosevelt's plan combined with widespread destitution, unemployment, and a raft of government programs, stimulated a Depression-era revival of mining across the West. In eastern Clear Creek County, experienced miners reopened idle properties with unemployed laborers forming a needed workforce. Adding to this resurgence, improvements in ore treatment rendered previously unprofitable ore viable to produce.

Overall, the revival in the eastern drainage was minor compared to activity of past decades, but the region witnessed a return to old mines on a scale not seen since the mid-1910s. Investors began directing their resources into the region as early as 1933, reopening former producers, rehabilitating underground workings, and repairing surface facilities. Although experienced managers and engineers oversaw some projects, most outfits did the best they could within severe financial constraints. They reused materials and machinery, erected poorly built structures, and conserved capital and supplies. The results were tangible and immediate, regardless. By 1934, annual gold production returned to levels capable of supporting local communities, and even contributing to the state's economy. At least 100 hardrock operations and eighty placer mines generated \$416,000 in 1934 and \$573,000 the following year. Gold, and jobs created by mining, drew the first wave of migrants seen in Clear Creek County in decades. The county's population increased approximately eighty percent from 2,155 people at the end of the 1920s to 3,784 by the late 1930s.²¹¹

Clyde M. Lyon, among migrant capitalists, organized one of the early Depression-era flagship companies. Lyon was born in Iowa in 1882, attended a business school in Des Moines when a young man, and went to work for a newspaper upon graduating. In 1905, Lyon married Janette Evans, and they homesteaded a claim in South Dakota. Probably because pioneering was difficult and uncertain, the family returned to Iowa and opened a mercantile. Still interested in the West, Lyon brought the family to Montana and raised cattle, did well, and moved to Fort Collins in 1923. He became involved in the local oil industry, investing in Texas oil as well, and expanding into mining.²¹²

In 1933, Lyon and Denver investor A. Downs organized the Alma Lincoln Mining Company, purchasing the Elliott & Barber, Josephine, and Lincoln Mine and Mill. The well-developed but idle properties were a ready-made operation on the south side of Clear Creek between Idaho Springs and Spanish Bar. Within the year, Lyon and Downs refitted the mill, hired a considerable workforce, and began mining fifty tons of ore per day. The daily tonnage, as much as any large company during the era of peak production, defined the Alma Lincoln company as most important contemporary producer in the eastern drainage (see Illustration A 1.2.27). Lyon moved from Fort Collins to Idaho Springs to manage operations, and the company maintained its status for much of the decade.²¹³

The Mattie Mine was another principal producer and employer near Idaho Springs. R.R. Mitchell and his father R.L. bought the Chicago Creek property at a bargain price in 1922, working it several times on a minor scale during the next five years. In 1933, they reorganized as Mattie Consolidated Mines, Inc. for additional capital, modernizing the Mattie Mill and

²¹⁰ McElvaine, Robert S. *The Great Depression: America, 1929-1941*. New York, NY: Times Books, 1993 [1984], 164; Saxon, 1959:7, 8, 12, 14, 16.

²¹¹ *Minerals Yearbook*, 1935:200; *Minerals Yearbook*, 1936:247; Schulz, 1976:1940-10.

²¹² *Tailings, Tracks, & Tommyknockers*, 1986:338.

²¹³ Colorado Mine Inspectors' Reports, Clear Creek: Alma; *Minerals Yearbook*, 1934:174.

producing heavily until 1935. Afterward, the Mitchells leased the property out and accepted custom business in the mill.²¹⁴

The owners of the Big Five Tunnel reopened in 1933 to lessees interested in Bellevue Mountain's gold veins. William Daniels' Big Five company drove the tunnel during shortly after 1900, produced heavily for several years, stalled, and went bankrupt in 1924. The remaining directors reorganized as the North American Mining Company but did little with the tunnel, subsequently known as the North American, because only low-grade ore remained. The Engineers Mining Company found the ore profitable to extract, signed a lease in 1933, and did well the rest of the decade.²¹⁵

Roosevelt's Gold Reserve Act of 1934 further improved conditions in the eastern drainage, stimulating a movement of large and small mining ventures alike. Joseph P. Ruth headed one venture that built the first new mill in years. Ruth was the principal behind the Denver-based Ruth Company, a construction firm organized during the 1910s to build surface plants and mills for mines. Ruth also invented milling apparatuses including the Ruth Rod Mill for fine ore crushing. He acquired the Golden Edge Mine on north Seaton Mountain through a lien, working it from the bottom up through the Newhouse Tunnel during the 1910s. Ruth suspended work within a few years when the ore declined in grade and costs exceeded profits, but reopened in the positive climate of 1934. He rehabilitated the underground workings through the Newhouse Tunnel, now known as the Argo, building the efficient Ruth Mill with appliances of his own design. While the mine produced heavily through much of the 1930s, the mill was central to local industry. Finished in 1935, it increased the area's overall ore treatment capacity, fostering the rise of numerous independent outfits.²¹⁶

The Argo Mill, at the mouth of the Newhouse Tunnel, served a similar function on a much larger scale. Horace W. Bennett and Denver investors initially leased the plant in 1934 to treat ore from Bismarck Mines, Inc., operating the Bismarck, Black Eagle, P.T., and Specie Payment mines. Within the year, Bennett concluded that the mill could be center to a greater ore treatment business supplied ore from additional operations around Idaho Springs. He and partners consolidated interests as the King Kong Mines Company and leased the Newhouse Tunnel, already in use for Seaton Mountain mines. Outfits on the mountain paid King Kong Mines royalties for use of the tunnel and ore treatment in the Argo Mill. Promoting the mill as a custom plant for the entire region, King Kong Mines also accepted payrock delivered by truck from other locations. Further enlarging the operation, Bennett and partners convinced Central City mine operators to work the depths of that district and send trains of ore through the Newhouse Tunnel. After costly rehabilitation, the tunnel and mill resumed their purpose as originally conceived, contributing heavily to the well-being of Idaho Springs during the 1930s.²¹⁷

Bennett, of advanced age, typified a Denver-based investor financially equipped to support large operations despite the Depression. Born in Michigan in 1862, Bennett became involved in a Detroit mercantile at age eighteen, moved to Milford after several years, acquiring an interest in a store. Selling in 1884, Bennett came to Denver and used capital to speculate on real estate. Successful, Bennett reinvested in more real estate until he attained the status of prominent developer. The gold boom at Cripple Creek drew Bennett into mining speculation, organizing the Bennett & Meyers Investment Company and the Bi-Metallic Investment Company. Bennett subsequently leveraged proceeds from his small fortune into greater ventures including the Denver Tramway Company, South Broadway National Bank, and Home Public

²¹⁴ Colorado Mine Inspectors' Reports, Clear Creek: Mattie; *Minerals Yearbook*, 1934:174.

²¹⁵ *Minerals Yearbook*, 1934:174.

²¹⁶ Colorado Mine Inspectors' Reports, Clear Creek: Golden Edge; *Georgetown Courier* (8/4/34): p1 c2; *Minerals Yearbook*, 1936:254.

²¹⁷ Colorado Mine Inspectors' Reports, Clear Creek: Argo, Bismarck; *Minerals Yearbook*, 1936:254.

Market Company. Although the Great Depression reduced his net worth, Bennett retained sufficient capital to lease several idle mines in Park and Clear Creek counties. Large mines such as the Newhouse required capital to reopen, but could potentially repay the cost and provide profits once operational.²¹⁸

As the mining revival gained footing throughout the eastern drainage, several vital service providers lent support, aware that a sound industry meant more business. In 1935, William Freeman, district manager for the Public Service Company, announced a twenty-five percent reduction in power rates to boost mining. The Colorado & Southern Railroad increased traffic to Idaho Springs, hauling greater tonnages of mill concentrates to smelters in Denver and Colorado Springs. Although the railroad benefitted the mining industry, it also gave the operators some reason for insecurity. In 1936, the railroad petitioned the Interstate Commerce Commission (ICC) to abandon its entire mountain system on grounds that financial losses were too great. The Clear Creek mine operators understood that their industry depended on rail service, even if on a reduced schedule. They rose up with compatriots in Gilpin County in a loud voice of protest, arguing that the industry was undergoing a measureable revival and needed the railroad for viability. Convinced, the commissioners postponed further hearings and required the Colorado & Southern to maintain service and find cost savings elsewhere.²¹⁹

Despite the railroad issue, the Depression-era revival peaked during the latter half of the 1930s as more ventures leased old mines and erected a few mills. The Consolidated Smelting & Metals Company leased the Black Eagle and Bismarck mines from Bennett, erecting a new flotation mill on Chicago Creek and linking it and mines with an aerial tramway. The company produced heavily beginning in 1936. S.S. Huntington leased the Specie Payment, Diamond Joe, Freighter's Friend, and Brighton mines in 1940, trucking the ore to the Black Eagle Mill. Lyon organized the Silver Spruce Gold Mining Company in 1939, erected another mill, and leased the Niagara Mine as a source of ore. Based on these and many small outfits, Idaho Springs maintained title as dominant town in Clear Creek County during the 1930s.²²⁰

Empire enjoyed a revival similar to Idaho Springs as local interests reopened principal mines in 1933, inspiring confidence in the area. Subsistence-level outfits proliferated and fed the local economy on a collective basis. Small parties worked the Mint and Gold Dirt, while local interests brought the Golden Eagle into production and treated the ore in a mill in town. In 1933, the Viking Gold Mines Company leased both the Conqueror mine and mill, hiring Albert Hanson as manager. He had been superintendent of the Bellevue-Hudson at Dumont previously and used his experience to restore the Conqueror back to full production. Viking then drew the Tenth Legion into the lease, producing consistently through 1939. The Gold Dirt Mining & Ore Reduction Company was another regular gold producer, also providing custom treatment for independent outfits. Frank Kistler organized the company in 1934, having made a fortune in the Texas oil fields. Kistler started with the Gold Dirt Mine, adding the Tenth Legion and Dunderberg in 1937.²²¹

Empire was also home to the Minnesota Mine, one of the county's greatest Depression-era gold producers. The operation began in 1934 when the D.A. Odell Mines Company leased the Atlantic, Comet, Crown Prince, and Minnesota mines on Silver Mountain, as well as the

²¹⁸ Baker, James H. *History of Colorado*. Denver, CO: Linderman Co., Inc., 1927, 82; Norman, Reuben O. *Who's Who of Denver 1931-1932*. Denver, CO: The Blue Book Company, 1932, 28; *Who's Who in Colorado: A Biographical Record of Colorado's Leaders in Business, Professional, and Public Life*. Boulder, CO: Colorado Press Association, University of Colorado, 1938, 215.

²¹⁹ *Georgetown Courier* (3/9/35): p1 c2.

²²⁰ *Tailings, Tracks, & Tommyknockers*, 1986:338; *Minerals Yearbook*, 1937:320; *Minerals Yearbook*, 1940:295; *Minerals Yearbook*, 1941:301.

²²¹ Colorado Mine Inspectors' Reports, Clear Creek: Conqueror; Gold Dirt; *Georgetown Courier* (9/30/33): p1 c3; Harrison, 1964:443; *Minerals Yearbook*, 1935:215; *Minerals Yearbook*, 1938:263.

Gold Dirt Mill to treat ore. Miners found a rich gold vein past operators missed in the Minnesota, tracing it through the company's other properties. The discovery caused a local sensation followed by close examination of adjoining claims for extensions. The company increased its workforce to seventy-five, making it one of the largest employers in the drainage. Production quickly overwhelmed the Gold Dirt Mill even though the company ran it day and night, leading to a new flotation plant north of Empire in 1936. With greater treatment capacity, Odell doubled the workforce again, reorganizing as Minnesota Mines, Inc. to consolidate assets and include additional investors. Empire had not seen an operation of this magnitude in decades, claiming title as most productive community in the county for several years as a result.²²²

Empire had a population large enough to support a full business district, new school, and several business ventures to meet industry demand. Robert Yonker opened a sawmill, a supply yard provided building materials, and Tulley Trucking hauled ore to various mills. Empire also featured several filling stations and hotels catering to both the mining industry and traffic over Berthoud Pass.²²³

During the latter half of the 1930s, Idaho Springs and Empire were the eastern and western poles of the Depression-era revival, the county's last significant period of mining. At the end of 1942, however, three events brought the period to a close. The Colorado & Southern Railroad applied to the ICC again in 1940 to abandon its mountain system. Although Clear Creek County interests protested, they inadvertently gave the ICC reason to decide in favor of the railroad. Intolerant of tri-weekly rail service, mining companies shipped much of their ore and supplies by truck, despite the cost. The railroad successfully demonstrated that its income was painfully low as a result and abandoned service in 1940. The mining companies now had no alternative to trucks, operating costs rising as a result.

The United States' entry into World War II at the end of 1941 and subsequent War Production Board Ruling L-208 were the other two events ending gold mining in the county. The federal government initiated a series of programs reallocating economic, material, and labor resources for wartime mobilization. At first, supplies critical for mining, such as explosives and gasoline, became nearly unavailable in 1942 except through rationing. Mining companies further suffered a lack of labor as workers either joined the armed services or moved into industries vital to the war effort. Unlike general resource allocation programs, War Production Board Ruling L-208 specifically targeted gold mining. The Roosevelt administration, which began the Depression-era revival in 1933 with an increase in the value of gold, abruptly reversed policy through the ruling. It mandated a suspension of gold mining by October 1942 on grounds that it did not contribute to the war effort and drained resources from the production of strategic metals and minerals.²²⁴

Loss of the railroad and other resources put mining under great strain, which Ruling L-208 solidified. Without being able to produce gold as a primary metal, one-half of mining operations in the county suspended work. A few claimed their intent was the production of industrial metals, and that any gold they realized was a byproduct. Such companies had to demonstrate that their ore possessed high percentages of industrial metals, which some ores in the county did. But most of the suitable veins had been exhausted decades ago, and the industry dwindled into a permanent state of torpor. Between 1942 and 1945, the number of active mines fell from forty-five to twenty-three, and gold production decreased from \$634,000 to \$31,000. A

²²² *Georgetown Courier* (10/20/34): p1 c2; Harrison, 1964:443, 446; *Minerals Yearbook*, 1935:215; *Minerals Yearbook*, 1936:253.

²²³ *Colorado Business Directory*, 1935:573; Harrison, 1964:450.

²²⁴ *Minerals Yearbook*, 1942:80; Saxon, 1959:17.

little silver and industrial metal mining continued, but it was too minor to offset mass closure of the gold producers.²²⁵

Mining never recovered locally. Small towns such as Empire, Dumont, Lawson, and Silver Plume reverted to 1920s population levels. Although people who stayed in the area optimistically worked old mines into the late 1960s, most activity was limited to underground sampling and minor development with no meaningful production.

²²⁵ *Minerals Yearbook*, 1942:320; *Minerals Yearbook*, 1945:313.

Section A 1.3: History of Mining at Frisco and Dillon, Summit County

Introduction

In Summit County, the I-70 corridor crosses the Blue River drainage and ascends southwest up Ten Mile Canyon on its way to Vail Pass. The Blue River and Ten Mile Canyon lie on the north edge of a mineralized region that made Summit County important in Colorado's mining history. Almost no mining occurred north of the corridor, while the county's well-known gold and silver districts including Breckenridge, Montezuma, and Robinson are well south. Somewhat removed, the Blue River and Ten Mile Canyon featured a localized industry and associated communities of Dillon and Frisco (see Illustrations A 1.3.1 and A 1.3.2). At Dillon, mining companies recovered placer gold from gravel deposited by Ten Mile Creek and the Blue River. Frisco, by contrast, supported hardrock silver mining extending south through Ten Mile Canyon to the Robinson Mining District, near the present-day Climax molybdenum mine.

The region's first Period of Significance began in 1878 with a wave of prospecting in Ten Mile Canyon following the discovery of silver. Mining began shortly afterward, giving rise to a fitful, inconsistent, and intermittent industry supporting the communities of Frisco and Wheeler. The period ended in 1885 when miners exhausted the richest ore and the value of silver fell. The area around Dillon and Frisco remained quiet until the federal government passed the Sherman Silver Purchase Act of 1890, increasing the value of silver. The Act ushered in a revival defining a second Period of Significance ending in 1893 with repeal of the Act and general economic collapse. A number of factors awoke the industry in 1898 from its depression and brought it into a third Period of Significance, when silver and industrial metals mining not only peaked in Ten Mile Canyon, but also gold production at Dillon assumed industrial proportions. The industry contracted sharply again in 1912 due to exhaustion of profitable ore and abandonment of the Denver & Rio Grande Railroad's Dillon Branch. A high demand for industrial metals and a price increase in silver due to World War I supported the industry's last Period of Significance beginning in 1916 and ending in 1920 when miners removed the last vestiges of ore. The Areas of Significance relevant to the Dillon and Frisco area include Architecture, Commerce, Community Planning and Development, Engineering, Industry, and Politics/Government.

Exploration and Early Development, 1859-1877

The Pikes Peak Gold Rush drew Ruben J. Spalding, veteran California placer miner, to the confluence of Cherry Creek and the South Platte River in 1859. When he arrived, he found the best ground already staked and realized that the area had little left to offer. Spalding accepted an invitation from George E. Spencer to join a party intent on prospecting the mountains, and they traveled west into South Park, encountering other miners already at Tarryall, Fairplay, and Buckskin Joe. As at Cherry Creek, the party found that prospectors held the most productive ground there and so ventured farther afield in hopes of being first to make a new strike. The party left Fairplay, traveled northwest deeper into the mountains, and descended into upper Blue River drainage. There, Spalding found gold in the gravel of the Blue River, and the party erected a few log cabins that became seed for the town of Breckenridge. During the first part of the summer of 1859, party members tried recovering gold from Blue River gravel, but the results were poor because the metal was too finely disseminated. Had they examined surrounding gulches, they would have found extremely rich deposits that were shallow and easily worked.²²⁶

²²⁶ Fiester, Mark *Blasted, Beloved Breckenridge* Breckenridge, CO: Weber's Books and Drawings, 1994 [1973], 16; Stone, 1918, V.1:265.

When provisions ran low, three individuals went to Denver for supplies and could not help but discuss their Blue River strike. Word spread among an audience primed by lack of profitable ground in existing gold fields, a few prospectors making their way to the Blue River. They began sampling tributary drainages around Spaulding's camp, striking profitable placer gold, and organized the region's first three mining districts. All were near the camp, which evolved into present-day Breckenridge, named for original prospecting party member Thomas E. Breckenridge. As winter approached, the prospectors prepared in various ways. Some returned to existing settlements on the more temperate plains, naturally sharing their experiences and reinforcing the stories already circulating. As placer fields elsewhere in Colorado Territory showed signs of exhaustion and migrants still arrived, presenting competition for diminishing resources, optimistic and desperate prospectors planned on the upper Blue River drainage as soon as conditions permitted.

The spring thaw of 1860 opened the drainage to a gold rush rivaling Gregory Gulch, Idaho Springs, and Fairplay. Hundreds of wealth-seekers made their way over Boreas, Hoosier, French, and Georgia passes. Both experienced parties and uninitiated known as tenderfeet realized success almost at once, finding placer gold in gulches throughout much of the Blue River valley. Late-comers, like Spalding at Cherry Creek, found gold-bearing ground already claimed and had to search outlying areas. Although archival sources make little mention, some individuals followed the Blue River north to present-day Dillon. They found a few placer deposits along the river, but because there were no parent gold veins, deposits were thin and quickly exhausted. Without gold, prospectors lost interest and returned south to the upper valley.

Breckenridge boomed through the first half of the 1860s, with mining continuing on a reduced level afterward. During the decade, knowledgeable prospectors sought placer gold's hardrock sources and were somewhat successful. In the eastern and southern reaches of the county, designated in 1861, individuals also found silver veins rich enough to justify development, drawing attention and even starting a minor rush to Montezuma. With silver now of interest, prospectors considered those portions of the county previously disregarded by placer miners. A few parties examined the Dillon area, finding the geology largely unfavorable except along the Ten Mile Range, on the valley's west side.

In 1865 or 1866, one group discovered a silver vein in the range's north end, claiming it as the Victoria. The vein was rich enough to attract investor General Buford, who purchased it in 1866. It remains unknown whether Buford's intentions were dishonest, or if he realized, after limited development, the ore was unprofitable and his investment a waste. He built a mill but vanished with the company funds when silver was not forthcoming. The net effect was twofold. On one hand, Buford demonstrated that the Ten Mile Range featured silver veins, but on the other, his failure clouded the range's reputation and discouraged further investigation. Thus, for years the area received little attention except among a few prospectors.²²⁷

Henry A. Recen was among those optimistic prospectors who understood the potential suggested by the Victoria. In 1871, he erected a cabin at the mouth of Ten Mile Canyon because of its strategic location, exploring the general area from this base camp. Recen was quickly rewarded with discovery of a silver vein on Mount Royal on the east side of the canyon mouth, claiming it as the Juno and Jura. Although unable to develop the vein due to a lack of funds, the find affirmed Recen's confidence, but did little to restore the area's reputation among others.²²⁸

Recen solicited brothers Andrew and Daniel as reinforcements in a larger prospecting effort, journeying to his homeland of Sweden to retrieve them in 1876. There, he also married

²²⁷ Gilliland, Mary Ellen. *Frisko! A Colorful Colorado Community*. Silverthorne, CO: Alpenrose Press, 1984, 17.

²²⁸ Gilliland, 1984:4.

Catherine Matson. The family returned to Recen's cabin, the brothers erected their own, and the residences became the area's first settlement. For the next several years, the brothers developed the Juno and sought additional veins amid the peaks during the warm months, working elsewhere when winter set in.²²⁹

Settlement and the Establishment of Industry, 1878-1885

In 1878, several events made the Recen camp a point of local interest. First was discovery of silver at Leadville, stimulating one of the greatest rushes in the Rocky Mountains. The Recens realized their camp lay on one of the most heavily traveled routes to the new mining district. During the late 1860s, several companies completed a wagon road from Georgetown west over Argentine Pass to the Blue River. There, the road met a north-south route connecting Breckenridge with Kemmling. When Leadville began booming in 1877, a toll company graded a third road from the junction past the Recen camp, south up Ten Mile Creek, and over Fremont Pass to Leadville. Georgetown was the major point of commerce at the eastern end of the road system, with the town becoming a gateway to Leadville. A high volume of traffic flowed through the Blue River and Ten Mile Canyon area. Dillon grew as a way-stop on the Blue River, and traffic lessened the isolation of Ten Mile Canyon and made the area better known. Most investors, however, overlooked the canyon and its resources in favor of Leadville, which commanded attention of the day.

Positive results from the Recens' prospecting campaign were other important event of 1878. During previous years, they searched Ten Mile Canyon from its mouth southward up to its head, on the north side of Fremont Pass, finding veins at both ends. Daniel found the Excelsior Vein on the west side of the canyon, nearly opposite Mount Royal and within sight of their camp. Henry discovered the Queen of the West and Andrew the adjoining Enterprise at the head, with the brothers also developing the Herculean Bar gold placer on Ten Mile Creek in between. The hardrock claims proved to be bonanzas, the brothers selling for handsome sums. They had an easy time with the Queen of the West and the Enterprise because these were prominent properties in the Robinson Mining District, which began booming that year. Although the Excelsior was also potentially rich and sold readily, Leadville and the Robinson district drew interest away from Ten Mile Canyon, granting the Recens one last year to find more veins before other prospectors joined the search. In 1879, the Recens located the Recen and Frisco Belle on the canyon's east side and the Ten-Mile Chief on Chief Mountain on the west, selling the latter two to Breckenridge investors. The brothers disposed of five proven claims, retaining two and running their small placer mine.²³⁰

The Recens' series of discoveries and a location on the road between Georgetown and Leadville drew optimistic prospectors and entrepreneurs to Ten Mile Canyon and the Blue River. Henry A. Learned came in 1878 at age forty-nine, joined W.A. Rand to look for silver, but suspended prospecting in favor of organizing the town of Frisco near the Recen camp in competition against Dillon. The partners proposed the idea to Denver investors, who provided money and expertise early in 1879 to formalize the Frisco Town Association and secure a tract of land. Peter Leyner moved from Boulder, provided money to the townsite company, and applied for a post office. Among the earliest entrepreneurs, Charles F. Shedd opened the first mercantile and sawmill, David C. Crowell the Frisco House hotel, and someone else a saloon. Dillon also continued growing during 1879 and received a post office. Architecture in the two towns was

²²⁹ Gilliland, 1984:5.

²³⁰ *Colorado Mining Directory*, 1883:788, 847; Gilliland, 1984:6.

typical of the mining frontier, with houses and commercial buildings constructed of logs, wood framing, or both. Many commercial buildings featured false-fronts, some had decorative elements, but exhibited no true architectural style. Instead, houses and commercial buildings tended to be vernacular, built for function, economy, and need, with little emphasis on intentional expression. This pattern remained in effect for decades.

Mining developed slowly at Frisco because Leadville and the Robinson district commanded attention, travelers providing most of the business. During 1879, the Recens worked their Juno and Recen properties, while other outfits developed the Excelsior, Frisco Belle, Mermaid, Mogul, and New York into minor producers. The Victoria reopened, and the Golden Gate Mining & Milling and Frisco Discovery & Mining companies began buying claims.²³¹

Mining in Ten Mile Canyon finally gained momentum in 1880, becoming a small industry the following year. The above mines yielded minor amounts of ore, and prospectors found a few other mineralized veins. After establishing Frisco, Learned resumed prospecting and discovered the Kitty Innes on Mount Royal. The vein was rich enough to interest Leadville investors William Graff, William R. Hall, and B.F. Stickey, who organized the Mount Royal Mining Company and began production. Most area activity was, however, speculative with little production because few bonanzas had been proven. Eastern investors organized several large companies whose primary function was buying and selling claims and stock. Learned was involved with the Royal Mountain Mining & Milling Company, with undeveloped property near the Kitty Innes, while others backed the Buffalo Mountain Silver Mining Company on Buffalo Mountain north of Frisco.²³²

These and other ventures not only supported both Frisco and Dillon, but also fostered the new settlement of Wheeler at today's Copper Mountain. Wheeler grew in response to local prospecting, logging, and traffic to Leadville, featuring a mercantile and post office secured in 1880. Wheeler remained small, however, because Frisco and Dillon dominated commerce at the crossroads. Frisco, in particular, boomed during 1880 and 1881. J.S. Scott and Doble & Stokes opened two more mercantiles, while B.B. Babcock, Isador Smith, and a Mr. Morrow ran three saloons. Leyner finished his Leyner House hotel and livery, as the Stafford House went into business. A population of 300 lived in town, with a like number scattered amid the surrounding mines and prospects. Dillon had an even more diverse assemblage of businesses, including a jeweler, barber, and surveyor.²³³

In 1881, the settlements around the Ten Mile Range received news further fueling the small boom. In their battle for supremacy of mountain freight business, both the Denver & Rio Grande (D&RG) and Denver, South Park & Pacific (DSP&P) railroads announced plans to grade lines into the Blue River valley. The history of these two carriers is discussed in detail in the railroad section. The D&RG already held a presence in Leadville and wanted to establish a line from there to Dillon to test the market in Summit County. The DSP&P, however, had a larger vision of incorporating Summit County into a new main line from South Park to Leadville. The route crossed from South Park to Breckenridge and went north down the Blue River to Placer Junction. The Leadville line veered west to Frisco, up Ten Mile Canyon, and over Fremont Pass, while a branch continued north to Dillon and east to the sawmills at Keystone. The D&RG reached Wheeler and established a station in 1881, terminating at Dillon the following year. The DSP&P reached Dillon later in 1882, ascending Ten Mile Canyon the next year.

²³¹ Bauer, et al., 1990:45, 59; Gilliland, 1984:10.

²³² *Colorado Mining Directory*, 1883:758, 832, 853; Gilliland, 1984:16.

²³³ Gilliland, 1984:12, 23.

When the two tracks were finished, Dillon, Frisco, and Wheeler enjoyed the service of not one, but two railroads, shifting local roles of these settlements. Dillon, farthest from the mines, became largely a railroad town and transportation center, while Frisco and Wheeler assumed most of the mining and logging business. For a short time, the railroads intensified the boom. Through reduced freight rates, they lowered costs of living and mine development and increased the amount and variety of goods available. The railroads also solved one of the most important problems that confounded the few mining companies in production, providing an inexpensive, all-season link with smelters at Leadville. Previously, companies shipped ore by wagon, which consumed profits and restricted production to only the highest grades of payrock. The railroads allowed companies to extract ore that was complex and lower in grade. The timing was good because high-grade ore, in short supply, neared exhaustion.

Although railroads held great potential for mining, they were unable to solve another fundamental problem preventing the industry from blossoming. Prospectors found relatively few veins offering ore in profitable tonnages besides the handful of mines such as the Excelsior, Kitty Innes, and Frisco Belle. The bubble was ready to burst by around 1882 because most activity was speculation, but the railroads prolonged the boom for a year or two. Most prospectors and investors, however, conceded defeat during 1883 and 1884, and Frisco and Wheeler came to rely on the handful of anchor mines. Whereas Dillon grew slightly because of the railroads, Frisco contracted, losing one-third of its businesses when the bubble deflated. The Frisco House Hotel continued, but Leyer sold his hotel to V.J. Coyne, one mercantile closed, and Morrow ran the only surviving saloon. In need of income, the town council resorted to taxing gaming tables and prostitution and required Morrow to pay for a liquor license.²³⁴

In 1885, the mining industry slumped further, and Frisco came to depend on logging. Locally, mining companies overestimated ore reserves, exhausted shallow veins, and realized that larger ones decreased in value and increased in complexity with depth. Outside the area, a synergy of forces eroded confidence in the silver market, driving values down. In particular, opponents of the silver standard shifted Treasury policy in favor of paper currency and loudly opposed the free coinage of silver. In 1885, the value of silver decreased from \$1.12 per ounce to \$1.06 and continued downward until bottoming at \$.94 in 1888. The watershed year, however, was 1886, when President Cleveland's stance became well known and silver reached \$1.00 per ounce, a watermark for mining investors. As a result, nearly all the mines in Ten Mile Canyon closed, prospecting nearly ended, and most workers left.²³⁵

Mining Revival, 1890-1893

The latter half of the 1880s was a difficult time for residents around Ten Mile Canyon. The value of silver continued to decline, ensuring that most mines remained shut. In response, Dillon, Frisco, and Wheeler increasingly relied on alternative sources of income, notably logging. All, however, languished to varying degrees. Dillon was the most stable with its railroad yards and ranching. Wheeler relied almost totally on its timber resources, which proved troublesome when the forests were cut over in later years. Frisco also depended heavily on logging and a small amount of mining activity. The Excelsior Mine still operated, and prospectors established the Wilkinson Mining District around five miles north. Frisco was the gateway to the new district, and as such, provided prospectors with supplies. The district, however, failed within a short time, and Frisco thus continued shrinking.

²³⁴ *Colorado Business Directory*, 1884:208; Gilliland, 1984:27.

²³⁵ Brown, 1984:191; *Report of the Director of the Mint*, 1894:20; Saxon, 1959:7-9, 14-17.

Remaining residents were rewarded for perseverance through uncertain times when politics surrounding silver turned in their favor. Passage of the Sherman Silver Purchase Act required the federal government to buy 54 million ounces of silver per year at \$1.05 per ounce, a demand and price capable of resuscitating the silver mining industry. As the increase rendered marginal grades of ore profitable to produce, mining revived in Ten Mile Canyon and Frisco. The owners of the Defiance, Juno, Monarch, and Myrtle resumed vein development, ore started emerging from the Frisco Belle and Emma J., and the Excelsior resumed regular production.²³⁶

The towns of Frisco and Wheeler directly benefitted from the new activity, Frisco's population almost doubling from around 100 during the late 1880s to 175 by 1893. Community leaders were unsatisfied, however, because few active mines were major operations. Responding to mine owners' need for local ore treatment, they aggressively sought mill operators by advertising free millsites and water rights for motive power, with lumber delivered. In this, they were unsuccessful, and owners of proven mines even had difficulty securing capital for systematic development. The reason was that Ten Mile Canyon was in the shadow of Leadville, the Robinson district, and Breckenridge, more important mining centers attracting investors' attention. Although the mining industry was not as vibrant as desired, it nevertheless sustained Frisco and Dillon until the fateful year of 1893, when the value of silver collapsed to previously unseen levels. The Silver Crash devastated Ten Mile Canyon, like the rest of Colorado. Most if not all mines closed and the regional economy collapsed. Dillon suffered when the railroads reduced their schedules and cut back on maintenance. Wheeler was nearly abandoned. Frisco became so quiet that there were no town board meetings until 1899. For the rest of the 1890s, Dillon and Frisco survived on ranching and small-scale logging.²³⁷

The Great Mining Revival, 1898-1912

A variety of factors revived silver mining as the 1890s waned, lifting the West out of a deep depression. Even though the value of silver did not recover from the Silver Crash, Frisco and Dillon residents saw their mining industry reach a zenith of activity shortly after 1900. The substantial revival was counterintuitive given silver's low value, but broad trends created an overall positive climate for mining and investment. First, the national economy recovered from the depression, reaching the West by the late 1890s. As economic conditions stabilized, investors felt secure enough to risk capital, and mining companies found loans and credit for projects. Second, railroad service improved, and goods and services were readily available again. Third, mine and mill owners, tired of bearing the costs of idle properties, extended themselves to bring operations back into production or sell or lease to investors who would. Fourth, the demand for industrial metals such as copper, lead, and zinc increased due to the revival of industry and consumerism. The ore in Ten Mile Canyon offered these metals in addition to silver. Finally, advances in technology and engineering decreased costs of ore production, while improved milling recovered even more metalliferous content than ever.

The revival began in Ten Mile Canyon in 1898 when capitalists seized upon principal mines known for past production. In keeping with a statewide trend, investors outside of Colorado paid for machinery and orderly underground development. They reopened the Juno and Kitty Innes, and began developing the Red Lion and Victoria. The Recens applied some of their proceeds to reopen the Recen and nearby IXL mines, installing one of the earliest electrical generators in the area. The Excelsior, Frisco's flagship producer, was subject to the largest

²³⁶ "General Mining News" *Mining Industry* (3/7/90): 118; "General Mining News" *MIT* (10/8/91): 162.

²³⁷ *Colorado Business Directory*, 1889:338; *Colorado Business Directory*, 1895:331; "General Mining News" *MIT* (7/16/91): 35.

transaction. Eastern investor Frank Wyborg purchased the mine, hired A.B. Ogden as manager, and charged him with developing it into a major operation. Although much high-grade ore had been removed from the vein long ago, plenty of low-grade material remained, and Ogden relayed that it could be profitable if concentrated locally. Thus, Wyborg provided money to build what may have been Frisco's first mill, as well as a hydropower plant to generate electricity.²³⁸

Colonel James H. Myers convinced wealthy investors to pour more capital into Ten Mile Canyon. Myers was born to a Virginia plantation family in 1844, joined the Confederacy when the Civil War erupted, and survived only to see the family holdings destroyed by the Union Army. Ruined, the family migrated to Colorado, where Myers dabbled in mining. Joining Montezuma's 1870s boom, he became an expert in local mining by speculating with ventures and printing the *Montezuma Prospector*. In 1898, Myers moved to Frisco, assessed the potential offered by Ten Mile Canyon, and floated several companies to buy the prominent mines on the east side. He postulated that lengthy haulage tunnels driven easterly from these mines would undercut the Victoria Vein and parallel formations at depth. The Victoria Vein was particularly intriguing, traceable from the Victoria Mine, through the Ten Mile Range, and over to the canyon. Myers was not altogether wrong, but underestimated the time and money required to achieve his goal.²³⁹

In 1899, Myers and distant investors organized two companies. The King Solomon Gold Mining Syndicate bought the King Solomon and began a tunnel into Mount Royal, while the Mint Mining & Milling Company pushed another tunnel into Ophir Mountain (see Illustration A 1.3.3). Both operations were well equipped and became several of Frisco's mainstays. In 1900, five more companies started their own tunnels into the range, including the Admiral, Ohio, Quandore, and Union.²⁴⁰

The flurry of activity restored a boom atmosphere to Frisco and Wheeler by 1900 (see Illustration A 1.3.4). Repeating the cycle of the early 1880s, opportunity and the demand for goods and services drew entrepreneurs to Frisco, where they joined seasoned merchants surviving the Silver Crash. Travelers and new arrivals found lodging in the Thomas, Frisco, and Southern hotels, dined in several restaurants, drank in eight saloons, and kept horses in a livery. Local workers billeted in John Hays' boardinghouse or with families, purchasing goods in mercantiles run by Hattie Learned, Peter Prestrund, and Nils Nilander. The number of children exceeded the capacity of the existing school, which moved to another building. Around thirty miners and loggers returned to Wheeler, supporting a store and saloon.²⁴¹

Dillon was center to its own small mining industry. Several companies realized they could profit from low-grade placer gold on the flanks of the Blue River by processing gravel in economies of scale. In 1899, J.H. Woolsey leased the Ryan Placer, built infrastructure for a hydraulic operation, and erected boardinghouses for a large workforce. At the same time, Breckenridge placer mine operator George E. West organized the Oro Grande Mining Company, acquired a group of claims adjacent to the Blue, and arranged a massive operation. He not only financed a hydraulic system, but also began a deep pit equipped with pumps and siphons, imitating similar pits in development near Breckenridge. West subsequently realized a fortune

²³⁸ *Colorado Mining Directory*, 1898:302; Gilliland, 1984:41, 58; *Summit County Journal* (12/3/98): 1; *Summit County Journal* (12/10/98) p1; *Summit County Journal* (1/21/99): 1; *Summit County Journal* (4/15/99): 1; *Summit County Journal* (10/14/99): 1.

²³⁹ Gilliland, Mary Ellen. *Summit: A Gold Rush History of Summit County, Colorado*. Silverthorne, CO: Alpenrose Press, 1999, 296; Sharp, Verna. *A History of Montezuma, Sts. John, and Argentine: Early Mining Camps of Summit County*. Dillon, CO: D & L Printing, Inc., 1971, 11.

²⁴⁰ Gilliland, 1984:46; "Mining News" *Mining Reporter* (8/23/1900): 117; "Summit County" *Mining Reporter* (2/22/1900): 106.

²⁴¹ *Colorado Business Directory*, 1901:762; Gilliland, 1984:46.

from gold dredging on the Blue. The population of Dillon increased from 200 to 250 residents due to the mechanized placer operations.²⁴²

The mining industry peaked during the next several years, with deeper and more advanced projects characterizing the revival. The Excelsior Mine, based on sound management, yielded handsomely, its mill so effective Ogden accepted ore from other mines to supplement income. In 1901, Al Moore struck a rich vein in the Etta M., began production and charted a haulage tunnel. The partnership of Matson & Westland encountered two more veins in an extension of the Victoria, while Cherryhome & Benton shipped ore from the Juno. Chauncey C. Warren and the Monroe Mining & Milling Company struck silver, building a tramway from the mine down to the DSP&P. Warren, with experience mining around Breckenridge, took his proceeds to Dillon, where he was elected mayor. At Wheeler, miners drove the Ten Mile Tunnel and contracted with the Gold Pan Mining Company shops near Breckenridge for a waterwheel plant and compressor.²⁴³

In 1903, the old Victoria Mine, on the east side of the mountain range, became one of Frisco's most important producers. E A. Keables, J.D. Alliunde, H.D. Crawford, and S.M. Stewart organized the Masontown Mining & Milling Company, bought the property, and commissioned a major development campaign. Keables was an investor and merchant in Breckenridge who made a small sum with several operations in Park County during the 1880s. The company established the settlement of Masontown, built a mill, and undercut the Victoria Vein eastern terminus with a deep tunnel. In its first year, the company realized enough profit to pay its debts, which was rare.²⁴⁴

The troublesome pattern of baseless speculation continued, as well. The Square Deal Company was organized in 1901 primarily to bilk distant investors. Termed the Crooked Deal Mine by James Myers, the outfit promoted a lengthy tunnel on North Ten Mile Creek, surveying its own townsite to excite investors. Although the company had no hope of finding ore and never developed the townsite, it spent a huge amount of capital on advanced machinery and the tunnel.²⁴⁵

Electricity contributed to and was characteristic of the mining revival. Power offered cost savings because companies could replace steam equipment with motor-driven machinery, which was more efficient especially at deep tunnels. Most companies, however, could not justify the expense of their own electrical plants, thus continuing to rely on steam. The Excelsior Mine at Frisco and Oro Grande company at Dillon pioneered electrification in the area through cooperation with their host communities. The towns lacked the money and customer bases for dedicated power plants, while the companies could not bear the costs for in-house use alone. When Ogden erected the Excelsior Mill and power plant in 1898, he contracted with Frisco to provide surplus power for lighting. The increased base and subscription fees offset some of Ogden's costs. Dillon and Oro Grande company came to a comparable agreement when that company built a hydropower plant immediately north of town. The deals enormously benefitted all parties.²⁴⁶

²⁴² *Colorado Business Directory*, 1898:414; "Mining News" *Mining Reporter* (6/1/99): 20; "Mining News" *Mining Reporter* (1/25/1900): 52.

²⁴³ "Mining News" *Mining Reporter* (1/3/01): 7; "Mining News" *Mining Reporter* (7/25/01): 66; "Mining News" *Mining Reporter* (6/13/01): 398; "Mining News" *Mining Reporter* (8/8/01): 107; "Mining News" *Mining Reporter* (9/19/01): 216; "Mining News" *Mining Reporter* (10/10/01): 284; "Mining News" *Mining Reporter* (10/2/02): 278.

²⁴⁴ "Mining News" *Mining Reporter* (3/12/03): 249; "Mining News" *Mining Reporter* (10/1/03): 316; "Mining News" *Mining Reporter* (10/15/03): 366; "Mining News" *Mining Reporter* (11/5/03): 446.

²⁴⁵ Gilliland, 1984:57.

²⁴⁶ *Summit County Journal* (12/10/98): 1; *Summit County Journal* (4/15/99): 1; *Summit County Journal* (10/14/99): 1; *Summit County Journal* (8/19/99): 4.

During the next five years, three more mining companies in Ten Mile Canyon built their own power plants in the absence of centralized service. The Recens financed their own DC hydropower plant at the Recen and IXL mines in 1898. The owners of the Admiral Tunnel, near Wheeler, built a hydropower plant in 1902, luring away the Excelsior electrician to oversee its operation. James Myers fronted the capital for a generator at the King Solomon Tunnel in 1904. Ultimately, the plants became the seed of a localized power grid, as discussed in the section on electric power.²⁴⁷

After three years of intense activity, the mining revival waned. Small mines exhausted their shallow ore reserves and closed after fruitless underground exploration. At large projects, investors wearied of the constant demand for money with no return and tightened their purse strings. By 1904, the industry consisted primarily of operations either yielding ore or led by experienced individuals, and even some of these were troubled. In the Excelsior, miners lost the vein and Ogden spent capital on extensive exploration to find it again. Myers still pushed the King Solomon and Mint tunnels, and although he claimed that several veins had been penetrated, ore was not forthcoming. The Masontown company was in deep financial trouble and suddenly closed the Victoria Mine, laying off its large workforce.²⁴⁸

The Mary Verna Mining Company thwarted the growing trend. The company began developing the Mary Verna and North American mines, on the east side of Ten Mile Canyon around 1903. The company erected an advanced surface plant on the DSP&P, which graded a siding for the complex known as Curtin. In 1905, the Mary Verna Tunnel struck ore, the company installed a generator and other machinery, and the mine yielded for several years.²⁴⁹

Broad economic cycles impacted mining around Frisco and Dillon once again when a national recession struck in 1907, exacerbating the decline. Credit became difficult to obtain, loans were recalled, with investors unwilling or unable to finance projects. These conditions brought profitless and speculative ventures to an end and forced productive but overcapitalized mines to suspend. This was the case with the Oro Grande company and its large-scale placer operation at Dillon. The company cleaved its placer workings from the power plant, selling the former to the Buffalo Gold Placer Mining Company and the latter to the Summit County Power Company. In Ten Mile Canyon, the Excelsior, Mary Verna, King Solomon, and Juno were the principal operations, while most others closed. The Summit Mining Company was a late success, producing enough payrock in 1907 to justify a tramway down to the DSP&P. Meanwhile, investors still funneled money into the Square Deal tunnel despite the poor economic climate and lack of returns.²⁵⁰

For the next five years, the above mines and limited logging were the stalwarts of the regional economy. In 1910, the King Solomon Tunnel finally reached a vein of worth and, after ten years of financial drain, began repaying investors. The tunnel was nearly 5,000' long, made possible with electricity from the company powerhouse. The Excelsior continued producing ore, treating the material in its mill, and generating power for Frisco. The Buffalo Gold company was Dillon's largest operation, while president Lemuel Kingsbury abandoned the deep pit on the Blue but maintained the hydraulic system in the other workings. Kingsbury was an efficient manager, having previously run the Iowa Hill hydraulic placer at Breckenridge. In 1910, he formally quantified the gravel deposits with prospect shafts and instituted production with a steam shovel

²⁴⁷ *Breckenridge Bulletin* (12/3/04): 1; *Summit County Journal* (12/3/98): 1; *Summit County Journal* (1/21/99): 1; *Summit County Journal* (11/15/02): 1.

²⁴⁸ *Mineral Resources of the United States*, 1905:211; "Mining News" *Mining Reporter* (3/31/04): 331; "Mining News" *Mining Reporter* (12/1/04): 592; "Mining News" *Mining Reporter* (6/1/05): 555; "Mining News" *Mining Reporter* (8/31/05): 219.

²⁴⁹ *Breckenridge Bulletin* (10/28/05): 1; "Mining News" *Mining Reporter* (2/23/05): 224; "Mining News" *Mining Reporter* (5/18/05): 511.

²⁵⁰ "Mining News" *Mining Reporter* (5/16/07): 457; "Mining News" *Mining Reporter* (7/17/07): 365; "Mining News" *Mining Reporter* (8/29/07): 203.

on rails, an innovative practice for the time. He also developed his own sluices fitted with Kingsbury riffles to catch fine gold. The operation was so successful that Kingsbury expanded several times.²⁵¹

The few principal mines at Dillon and in Ten Mile Canyon maintained production during the early 1910s despite growing uncertainty regarding reliable transportation. The Colorado & Southern Railroad (C&S), which purchased the DSP&P system in 1898, determined the Leadville line through Summit County unprofitable and sought to abandon it. The C&S argued that the D&RG siphoned Leadville traffic via its Arkansas Valley route, and Summit County business was insufficient to offset costs. The C&S abruptly suspended service in 1910 without formal permission from the Interstate Commerce Commission, leaving the D&RG's Dillon branch as the only rail link. But because C&S dominated Summit County, D&RG had reduced Dillon service to several trains per week. The irregular schedule impacted mining throughout the county because companies were unable to ship ore to Leadville smelters on a consistent basis. The Breckenridge Chamber of Commerce successfully obtained a court order forcing C&S to restore service, which it did on a greatly reduced schedule. The next year, Summit County lost D&RG's Dillon branch, leaving the unwilling C&S as the only carrier. In 1911, C&S and D&RG agreed that Summit County did not generate enough freight business to justify both railroads and came to an agreement. The D&RG offered to abandon its Dillon branch, granting C&S a monopoly in Summit County if C&S turned over its Gunnison track to D&RG. After 1911, Summit County relied exclusively on the C&S, which still expressed interest in closing the line. The uncertainty discouraged further investment, with a chilling effect on the mining industry.

The transportation issue compounded deeper problems that brought the revival to end in 1912. After more than ten years of intermittent production, the handful of existing companies exhausted their profitable ore reserves. A few properties still possessed some payrock, but it was complex, low in grade, and deep. All but the Excelsior, King Solomon, and several small outfits closed, with even these operating on reduced levels. The industry was no longer viable. Dillon felt the loss but weathered the slump due to a diverse economy that included logging, ranching, and the railroad. The town's population remained at around 200, supporting an array of businesses. Frisco, by contrast, went into a sharp decline. The population fell to around 100, with only basic businesses remaining open. Town council rarely met, and attendance was insufficient to manage basic affairs. As a result, the town let its contract for power lapse, signifying the final collapse of the mining revival in 1912.²⁵²

World War I Revival, 1916-1920

The problem of impoverished and complex ore in Ten Mile Canyon had no solution given the low metals prices of the early 1910s. This changed later in the decade, allowing Frisco and its mining industry a final period of measurable activity. As discussed in the section on Clear Creek County, conditions created by World War I pushed the values of silver and industrial metals to levels unseen since 1890. European governments began buying silver, and the demand for copper, lead, and zinc soared due to weapons production. By 1916, two years after the war began, prices of these metals became high enough to render low-grade ores profitable to produce. Values and demand kept climbing through the late 1910s. Under these positive conditions, a new type of investor took interest in the mines of Ten Mile Canyon, constituting an important local movement. These investors were unwilling to pay large sums for existing mines or equip them

²⁵¹ "Current News" *Mining Science* (6/9/10): 548; "Current News" *Mining Science* (8/18/10): 163; "Current News" *Mining Science* (11/10/10): 453; *Mineral Resources of the United States*, 1911:562.

²⁵² *Colorado Business Directory*, 1910:634, 648; Gilliland, 1984:69.

with advanced machinery. Instead, they leased known producers, financing only necessary improvements and extracting ore from old workings. Because the mines had aged infrastructures and worn machinery, however, rehabilitation efforts were capital-intensive.

In 1916, leasing companies took over the two most productive mines, the Excelsior and King Solomon. At the Excelsior, the mill was brought back into operation, processing ore from its lessees as well as other mines. This custom service was instrumental to success around Frisco. Other lessees reopened the Columbine and Queen of the West, which still offered ore. Other groups joined in 1917, reopening the Four-Most, Hyman Tunnel, and several poorly developed properties. Overall, the revival remained selective and limited in impact. Activity was insufficient to restore life to the abandoned hamlets of Wheeler, Curtin, and Masonville, nor did it engage the exhausted placer mines around Dillon. The revival did, however, provide Frisco's economy with a footing, arresting gradual decline.²⁵³

World War I ended in 1918, but demand for metals remained high while the value of silver continued increasing afterward as Europe rebuilt its infrastructure and economy. Unfortunately for Frisco, this was inconsequential. When World War I began, the mines had little ore left, and leasing parties extracted the last vestiges of what remained within a few years. The Excelsior closed in 1919, and when the mill ceased, small outfits had no local facility to treat their low-grade payrock and suspended. Lessees at Columbine and Hyman Tunnel stopped work, with only the King Solomon and Four-Most remaining active. In 1920, these mines shuttered as well, leaving Frisco with no operations of substance. Frisco's last mining revival ended, and the industry was never again viable.

During the early 1920s, Frisco and Dillon were without any operating mines for the first time in nearly twenty-five years. Afterward, some activity resumed, but it was too minor and intermittent to qualify as an industry of note. At various times in the decade, small leases gleaned ore from the King Solomon and Etta M. workings, suspending with the Great Depression. When the values of gold and silver increased during the Depression, lessees searched out the last pockets of ore in the Excelsior, Frisco, and Chief mines. The operations were short-lived like many others of the era, producing only enough ore for a subsistence income. In confirmation that Ten Mile Canyon and the Dillon area would never again host mining on a measurable scale, the owners of the Excelsior dismantled the mine's surface plant in 1935, and the C&S abandoned the county's last rail line in 1937.

²⁵³ Colorado Mine Inspectors' Reports, Summit County: Excelsior, King Solomon; *Mineral Resources of the United States*, 1916:380.

Section A 1.4: Mining and Milling Methods, Technology, and Equipment

Following is a discussion of the general methods and technologies used to find and extract metals from the hardrock and placer deposits in the I-70 corridor. In many cases, specific methods and technologies correspond to particular Periods of Significance, while others apply over the course of the corridor's mining history from 1859 through 1942. This portion of the text has been adapted from Section E of two previous Multiple Property Documentation Forms, *The Mining Industry in Colorado* (revised 2008), and *Historic Mining Resources of San Juan County, Colorado*.²⁵⁴ Adaptation is with permission from author Eric Twitty. Content relevant to mining in the corridor is presented in an edited format.

Placer Mining

The Nature of Placer Deposits

For thousands of years, humankind prized gold for its rarity, appearance, malleability, and chemical stability. Gold oxidizes and forms compounds only under unusual physical circumstances and otherwise remains in its native state. Superheated fluids and gases associated with geothermal and magmatic activity tend to deposit gold in the forms of veins, replacement bodies, and disseminated deposits in rock formations. Typically, mountain-building events such as those that uplifted the central Rocky Mountains created the fluids, gases, and geologic conditions for gold ore, which often included other metals such as silver, lead, and zinc.

Over the course of eons, erosion attacked the mountains and dismantled the ore veins that cropped out on ground-surface. Most of the minerals and metals were washed into waterways where they suffered reduction and dissolution, both physically and chemically, decomposing into sediments. Stream action concentrated the sediments on the floors of drainages, with high runoff mobilizing the sediments and washing them downstream.

Because gold is soft and inert, however, it neither dissolves nor forms chemical compounds and only slowly disintegrates through physical reduction. Hence, as erosion freed gold from its parent veins, the particles migrated into nearby drainages and slowly sifted downward into the gravel floors due to their weight. As each high runoff event mobilized and shifted the stream gravel, the gold particles worked their way down toward the bedrock floor where they became concentrated and remained for thousands of years. Over time, water carried the gold from small, steep gulches near parent veins into streams and then rivers.

Because erosion is an unending process, fresh gold was constantly freed from its parent veins while the older material continued to accumulate on the bedrock floors. Hence, fine gold disseminated throughout the upper strata of a stream's gravel often represented a richer deposit at depth. Overall, miners termed gold-bearing gravel *placer deposits* and referred to broad areas of such gravel as *placer fields*.

In Clear Creek and Summit counties, prospectors and miners encountered five principal types of placer deposits. The first, known as *gulch placers* or *gulch washings*, consisted of gold-bearing gravel lining the floors of steep, minor drainages. Because gulch placers lay near a parent vein, offered few places for fine material to settle out, and were subject to high-energy stream flows, the gravel tended to be coarse, the gold particles large and rough, and the gravel

²⁵⁴ Fell, Jay and Twitty, Eric *The Mining Industry in Colorado Multiple Property Documentation Form* Denver: Office of Archaeology and Historic Preservation, Colorado Historical Society, 2008; Twitty, Eric *Historic Mining Resources of San Juan County, Colorado Multiple Property Documentation Form* Denver: Office of Archaeology and Historic Preservation, Colorado Historical Society, 2010.

beds thin. Easily discovered and worked with relatively little effort, gulch placers were first to be found and yielded through hand-mining.

Miners recognized the second deposit as a *stream or river placer*, created when minor streams introduced gold into principal waterways such as Clear Creek in Clear Creek County. The gravel was thick and required extensive excavation and engineered structures to remove enough overburden to expose the deep gold-bearing layers. Stream placers tended to be the domain of mining companies with capital and substantial workforces.

River bar placers, the third deposit, were beds of gravel exposed along the sides of principal streams and on the inside of meanders. They represented an earlier level of a drainage floor, often consisting of glacial till and general gravel.

The fourth type, colloquially known as a *blanket deposit*, was limited to slopes where gold veins cropped out near ground-surface. Erosion and weathering attacked the veins and freed the gold, but runoff was insufficient to immediately shunt the metal into waterways, leaving a veneer of gold-bearing soil easily washed into sluices.

Deep placers, also known as *valley gravel*, constituted the fifth deposit. These filled the floors of broad, gently sloped drainages and consisted of gold distributed in glacial till and gravel. Stream action concentrated the coarsest gold along bedrock, leaving fine gold in the upper gravel strata. The broad Blue River valley near Dillon offered valley gravel deposits, but Clear Creek County did not have extreme terrain and lack of rivers.

Prospecting for Placer Gold

While each placer deposit type lent itself to specific processing methods, all could be discovered by basic prospecting. A prospector merely had to excavate pits in stream gravel and reduce the material in a gold pan. The presence of a few gold flakes from the upper gravel suggested the potential for more at depth, spurring the prospector to dig deeper pits. By the late 1850s, experienced prospectors understood that the worth of a deposit could only be accurately assessed by testing gravel from near bedrock, requiring considerable labor to expose. If the prospector confirmed the presence of placer gold in profitable quantities, he was ready to begin mining.

Placer Mining Methods

One of placer mining's main attractions was that it was within practical and economic reach of both individual miners and organized companies. Gulch, river bar, and blanket placers saw mining by individuals working by hand, and by companies with complex systems that depended on infrastructures. River placers, however, tended to be the domain of capitalized companies because they required capital investment for flumes, long sluices, and workforces to excavate high volumes of material.

When working by hand, individual miners often employed pans, cradles, and small sluices to separate gold from gravel (see Illustration A 1.4.1). Miners merely excavated pits and trenches into streambeds, and when they approached bedrock, the miners shoveled the gold-bearing material into a cradle or sluice. A cradle was a portable wooden box with a rounded bottom, a slanted board featuring riffles, and a lever. The miner rocked the cradle back and forth while introducing water, which washed off the gravel and left the heavy gold trapped behind the riffles. A sluice was a small, portable wooden flume with riffles nailed to the floor. The miner placed it in a stream and shoveled gravel into the interior, and the flow of water washed the light gravel away. When miners exhausted the gold-bearing gravel in their pits and trenches, they

shifted laterally, began new excavations, and filled the old pits with new tailings. Over time, this created hummocky assemblages of tailings piles, pits, trenches, and buried excavations.

Organized mining companies had the same goals as individual miners, only they relied on infrastructures to process gravel in high volumes from groups of claims (see Illustrations B 1.1 and B 1.2). Companies often erected systems of sluices, work stations, water-diversion structures to move streams out their beds to expose gravel, and ditches and flumes to deliver water to otherwise dry areas. The sluices tended to be lengthy, featuring either several branches feeding into a trunk line or several parallel sluices. Common sluices ranged from 2' wide and as deep, to 4' wide and 4' deep. They stood on timber piers supported by timber or stacked rock footers and featured a gentle gradient so fine gold did not wash away. Workers usually installed the sluices in trenches and shoveled the surrounding gravel into the current flowing through the device. After prolonged excavation, workers reduced the height of the surrounding gravel until the sluice bed manifested as a raised berm.

When the sluice floor became choked with fine sediment, a worker closed the headgate and shut off the water flow so the gold caught behind the riffles could be recovered. Workers stepped down into the sluice and, under watch of a guard or superintendent, began removing large gold particles and scraping out gold-laden sand. The particles were collected and weighed while the sand was treated with mercury, which amalgamated with gold dust that was too fine to be easily picked out. After cleanup operations, the sluice was ready for more gravel and a worker opened the headgate, admitting water again.

While hand-methods were highly effective for gulch and blanket placers, the costs of labor were too high and the rate of processing too limited for most extensive deposits. By nature, these deposits tended to feature fine gold disseminated through broad, deep gravel beds that had to be mobilized and processed in economies of scale for profitability. Such conditions required the investment of considerable capital to build the necessary infrastructures, designed for several distinct processing methods.

One of the most popular and earliest was known as *booming*, which involved a torrent of water suddenly released from a nearby reservoir into placer workings. The rush of water mobilized and carried gravel en masse through sluices, where riffles often retaining mercury collected the gold. To facilitate both consumption of water in volume and processing large tonnages of gravel, companies professionally engineered their infrastructures. Networks of supply ditches pirated water from area streams and directed it to the placer mine and the reservoir. Distribution ditches shunted the liquid into the sluices, and boom ditches carried water from the reservoir into the workings. All featured headgates, and the sluice systems were as noted above.

Hydraulic mining, developed in California and practiced in Clear Creek and Summit counties, was another method for processing thick gravel beds in economies of scale (see Illustrations A 1.4.2, B 1.3 and B 1.4). A monitor, also known as a giant, was the key instrument. A monitor was a large nozzle emitting a jet of water under pressure so great that miners were unable to swing sledge hammers through it. A worker played the jet against gravel banks, which crumbled and liquefied, and with the help of booming, were washed into sluices. The infrastructure for hydraulic mining was similar to that for booming with additional components for the monitors. To create the necessary pressure, ditches delivered water to a reservoir located far upslope from the mine, and a flume or pipe directed water into a structure known as a pressure box. The structure was basically a rectangular tank made of planks retained by stout framing at least 6' wide, 6' high, and 8' long. A pipe known as a penstock, often at least 24" in diameter, exited the structure's bottom and descended to the mine, decreasing in diameter incrementally to increase the water current's velocity and pressure. The pipe entered the placer

workings and connected to a monitor located on a strategically placed station, commanding a full view of the gravel banks.

Hardrock Mining

The Nature of Hardrock Ore Deposits

Although placer gold initially drew prospectors into the I-70 corridor, it was hardrock ore that kept them in the region. In general, profitable minerals and metals found in the hard, metamorphic and igneous rock formations of the mountains constituted hardrock ores. The principal precious and semiprecious metals in the corridor were gold and silver, while principal industrial metals were lead, zinc, and copper.

The common traits shared by hardrock ores regardless of metal type, which influenced how companies mined them, were the nature of the ore formations themselves. Most were functions of uplift and subterranean magma that built the central Rocky Mountains. During periods of uplift, superheated magmatic bodies slowly intruded the basement rocks deep under the surface and exerted great pressure. As these bodies made their way upward, pockets of liquid rock, mineralized fluids, and gases attempted to escape through paths of least resistance. Faults and fissures oriented vertically provided these paths, ranging in width from microscopic to several feet. As the gases and fluids lost pressure and heat during ascent, insoluble minerals first precipitated out on the fault walls, followed by soluble minerals and metals with low melting points. The end product was an irregular and mineralized band or seam in bedrock, recognized by the mining industry as a *vein*. Most veins were barren, but some offered gold, silver, or industrial metals in various combinations, with only a few featuring rich pockets or stringers. Gold tended to manifest in native form, while silver and industrial metals tended to be locked in mineralized compounds. High-grade ore, rare and prized by mining companies, tended to have higher proportions of metals in pure form. Low-grade ore, by contrast, was complex, mineralized, with a limited metals content, and hence difficult to process.

Prospecting for Hardrock Ore

Finding the ore formations was the first step in hardrock mining, and this was the task of prospectors. Popular history suggests that individual or pairs of prospectors found rich gold and silver veins by simply excavating pits with pick and shovel, or wandered the countryside until they encountered rich outcrops. In actuality, successful prospecting involved a basic knowledge of mineralogy and geology, hard work, patience, and strategy and planning. Prospectors also rarely worked alone because parties ensured safety and security, increased the likelihood of finding ore through group efforts, and hastened examination and sampling.

The process often began with a cursory survey of an area featuring geological and topographical conditions suggestive of ore bodies. Prospectors often examined exposed bedrock for seams, quartz veins, dykes, unusual formations, and minerals rich with iron. Where vegetation, sod, and soil concealed bedrock, prospectors also scanned the landscape for anomalous features such as water seeps, abrupt changes in vegetation and topography, and changes in soil character.²⁵⁵

²⁵⁵ Bramble, Charles A. *The ABC of Mining: A Handbook for Prospectors* (Santa Monica: Geology, Energy & Minerals Corporation, 1980 [1898]) 11-13; Peele, Robert *Mining Engineer's Handbook* (New York: John Wiley & Sons, 1918): 381-5; Young, George *Elements of Mining* (New York: John Wiley & Sons, 1946) 19-26.

If an area offered some of these characteristics, the party of prospectors may have shifted to more intensive examination methods. One of the oldest and simplest, employed for locating gold veins, began by testing steam gravel for gold eroded off a parent vein. By periodically panning samples, a party could track the gold upstream, and when members encountered the precious metal no more, they knew they were near the point of entry. The party then turned toward one of the stream banks and began excavating test pits and panning the soil immediately overlying bedrock in hopes of finding a continuation of the gold. They tested samples horizontally back and forth in attempts to define the lateral boundaries of the gold flecks, then moved a short distance upslope and repeated the process. Theoretically, each successive row of pits should have been shorter than the previous one, since erosion tended to distribute gold and other minerals in a fan from their point sources. By excavating several rows of pits, the prospectors were able to project the fan's upslope apex where, they hoped, the vein lay. Employing such a sampling strategy occasionally paid off, but the party of prospectors had to undertake considerable work digging pits with pick and shovel, hauling soil samples to a body of water over rough terrain, and panning in cold streams.²⁵⁶

One of the greatest drawbacks to systematic panning was that it detected only gold but missed silver and industrial metals, the foundation of mining in western Clear Creek and Ten Mile Canyon. To find minerals in addition to gold, prospectors scanned stream gravel and areas of exposed soil for what they termed *float*, or isolated fragments of ore-bearing rock. As with free-gold, natural weathering fractured ore bodies while erosion transported the pieces downslope, often in the shape of a fan. If the prospectors encountered ore specimens, they walked transects to define the boundaries of the scatter, narrowing the search to the most likely area. Applying the same methods used to locate gold veins, prospectors excavated groups or rows of pits, tracing ore samples until they could project where the vein supposedly lay. With high hopes, the prospectors sank several prospect pits down to bedrock and chipped away at the material to expose fresh minerals.²⁵⁷

If the exposed bedrock suggested the presence of an ore body, the party of prospectors may have elected to drive either a small shaft or adit (narrow tunnel) with the intent of sampling the mineral deposit at depth and confirm its continuation. After clearing away as much fractured, loose bedrock as possible with pick and shovel, a pair of prospectors began boring blast-holes with a hammer and drill-steels. They often bored between twelve and eighteen holes, 18" to 24" deep, in a special pattern designed to maximize the force of the explosive charges they loaded. Prior to the 1880s, prospecting parties usually used blasting powder, and by the 1890s, most converted to stronger but more expensive dynamite. Until economic ore had been proven, the operation was classified as a *prospect adit* or *prospect shaft*.

Deep Exploration and the Development of Ore Bodies

A *prospect* differed greatly from a *mine*. A prospect was an operation in which prospectors sought ore. The associated workings ranged from groups of pits to shallow adits or shafts with as much as hundreds of feet of horizontal and vertical passages. A mine, by contrast, usually consisted of at least several hundred feet of workings and a proven ore body. All mines began as prospect operations, and when prospectors determined the existence of ore, the activity at the mineral claim often shifted at first to quantifying how much ore existed, and then to profitable extraction. See Illustration B 1.5 for a prospect example, and B 1.6-B 1.9 for mines.

²⁵⁶ Bramble, 1980: 11-13; Peele, 1918: 381-5; Young, 1946: 19-26.

²⁵⁷ Ibid.

The general methods by which prospectors and miners searched for and extracted ore and equipped their mines to do so were universal throughout the west. The I-70 corridor was no exception, and methods there fell into common patterns. The most elementary was converting the prospect into a mine once a company proved ore. Usually, the company hired a crew of miners who proceeded to enlarge the prospect adit or shaft and systematically block out the mineral body. At the point where a tunnel or shaft penetrated the formation, miners developed it with internal workings consisting of *drifts* driven along the vein, *crosscuts* extending 90 degrees across the vein, internal shafts known as *winzes* which dropped down from the tunnel floor, and internal shafts known as *raises* which went up. Drifts and crosscuts explored the length and width of the ore, and raises and winzes explored its height and depth.

Miners and prospectors consciously sank shafts or drove adits in response to fundamental criteria. A shaft was easiest and the least costly to keep open against fractured and weak ground, and it permitted miners to stay in close contact with an ore body as they pursued it. A shaft also lent itself well to driving a latticework of drifts, crosscuts, raises, and winzes to explore and block out an ore body.

Mining engineers discerned between vertical and inclined shafts. One contingent of engineers preferred inclined shafts because mineral bodies descended at an angle, albeit steep. In addition, inclined shafts needed smaller, less expensive hoists than those used for vertical shafts. The other camp of engineers, however, claimed that vertical shafts were best because maintenance and upkeep on them cost less. Vertical shafts had to be timbered merely to resist swelling of the walls, while timbering in inclines had to also support the ceiling, which was more expensive, especially when the passage penetrated weak ground. Inclined shafts also required a weight-bearing track for the hoist vehicle, which, including maintenance such as replacing rotten timbers and corroded rails, consumed money.

An adit or tunnel, by contrast, was easier and faster to drive and required significantly less capital than a shaft. Some mining engineers determined that the cost of drilling and blasting a shaft was as much as three times more than an adit or tunnel. Prospectors and mining engineers alike understood that adits and tunnels were self-draining, required no hoisting equipment, and transporting rock out and materials into the mine was easier. However, adits and tunnels were not well-suited for developing deep ore bodies because interior hoisting and ore transfer stations had to be blasted out, proving costly and creating traffic congestion. One other problem, significant where the rock was weak, lay in the enormous cost of timbering the passages against cave-in. While the exact differentiation between a tunnel and an adit is somewhat nebulous, mining engineers and self-made mining men referred to narrow and low tunnels with limited space and length as *adits*. Passages wide enough to permit incoming miners to pass outgoing ore cars, high enough to accommodate air and water plumbing suspended from the ceiling, and extending into substantial workings have been loosely referred to as *tunnels*.²⁵⁸

Despite the hypothetical advantages of shafts or tunnels, in some cases factors beyond miners' or engineers' control governed the actual choice. Geology proved to be a deciding criterion; steep hillsides, deep canyons, and gently pitching ore bodies lent themselves well to development through tunnels. In many cases prospectors who had located an outcrop of ore high on a hillside drove an adit from a point considerably downslope to intersect the formation at depth, and if the ore body proved profitable, then the mining company carried out extraction through the adit.²⁵⁹

²⁵⁸ Twitty, Eric *Riches to Rust: A Guide to Mining in the Old West* (Montrose, CO: Western Reflections, 2020) 36.

²⁵⁹ Colliery Engineer Company, *Coal & Metal Miners' Pocketbook* (Scranton: Colliery Engineer Company, 1893) 257; International Textbook Company, *A Textbook on Metal Mining: Steam and Steam-Boilers, Steam Engines, Air and Air Compression, Hydromechanics and Pumping, Mine Haulage, Hoisting and Hoisting Appliances, Percussive and Rotary Boring* (Scranton: International Textbook Company, 1899) A40:8.

One additional, significant factor influenced the decision to sink a shaft instead of driving a tunnel. Historians of the west aptly characterized intense mineral rushes as frenzies of prospectors who blanketed the surrounding territory with claims. In most districts, including those in the I-70 corridor, the recognized hardrock claim was 1,500' long and 300' to 500' wide, which left limited work space both above and below ground. A shaft was the only means to pursue a deep ore body within the confines of such a claim.²⁶⁰

The Mine Surface Plant

Driving underground workings required support from facilities on the surface. Known among miners and engineers as the *surface plant*, these facilities were equipped to meet the needs of work underground. Large, productive mines boasted sizable surface plants while small prospect operations had simple facilities. Regardless of whether the operation was small or large, the surface plant had to meet five fundamental needs. First was a stable and unobstructed entry underground. Second was a facility for tool and equipment maintenance and fabrication. The third allowed transportation of materials into and waste rock out of the underground workings. Fourth, the workings had to be ventilated, and fifth was the storage of thousands of tons of waste rock generated during underground development, often within the boundaries of the mineral claim. Generally, both productive mines and deep prospects had needs in addition to the above basic five requirements, and their surface plants included necessary components.

A basic surface plant, whether haphazardly constructed by inexperienced prospectors or designed by experienced mining engineers, consisted of a set of *components*. In terms of underground operations, the entry usually consisted of a shaft collar or a tunnel portal, and small-scale circulation systems facilitated men and materials into and out of these openings. At tunnel operations, miners usually used ore cars on baby-gauge rail lines, and at shafts, a hoisting system lifted vehicles out of the workings. Materials and rock at shaft mines were usually transferred into an ore car for transportation on the surface. The surface plants for all types of mines included a blacksmith shop where tools and equipment were maintained and fabricated, with machining and carpentry facilities at large mines. Most plant components were clustered around the tunnel or shaft and built on cut-and-fill earthen platforms made when workers excavated material from the hillslope and used the fill to extend the level surface. Once enough waste rock had been extracted from the underground workings and dumped around the mouth of the mine, the facilities may have been moved onto the resultant level area. The physical size, degree of mechanization, and capital expenditure of a surface plant was proportionate to the workings below ground.

In addition to differentiating between surface plants serving tunnels from those at shafts, mining engineers further subdivided mine facilities into two more classes. Engineers considered surface plants geared for shaft sinking, driving adits, and underground exploration to be different from those designed for ore production. Exploration facilities were referred to as *temporary-class plants*, and as *sinking-class plants* when associated with shafts. Such facilities were by nature small, labor-intensive, energy inefficient, and most important, required little capital. *Production-class plants* on the other hand usually represented long-term investment and were intended to maximize production while minimizing operating costs such as labor, maintenance, and energy consumption. Such facilities emphasized capital-intensive mechanization, engineering, planning, and scientific calculation.

²⁶⁰ Morrison's *Mining Rights*, Denver, CO, 1899:17, 20; Peele, 1918:1474.

Mines underwent an evolutionary process in which the discovery of ore, driving a prospect shaft or tunnel, installation of a temporary plant, upgrade to a production plant, and eventual abandonment were points along a spectrum. Depending on whether prospectors or a mining company found ore and how much, a mine could have been abandoned in any stage of evolution. Engineers and mining companies usually took a cautionary, pragmatic approach when upgrading a sinking plant to a production plant. Until significant ore reserves had been proven, most mining companies minimized their outlay of capital by installing inexpensive machines adequate only for meeting immediate needs.

Mining engineers extended the temporary and production-class classifications to structures including machine foundations. Because of a low cost, ease of erection, and brief serviceable life, timber and hewn log machine foundations were temporary, while production-class versions consisted of concrete or masonry. In structure characteristics, wooden foundations usually consisted of cribbing, a framed cube, or a pallet buried in waste rock for stability and immobility. The construction and classification of machine foundations is of particular importance because they often convey the composition of a surface plant.²⁶¹

Surface Plants for Tunnels

The surface plants for tunnels and shafts shared many of the same components. And yet, because of fundamental differences between these two types of mines, the designs and characteristics for each were different. Following is a list of the principal components found at most tunnel operations.

The Tunnel Portal

The tunnel portal was a primary component of both simple prospects and complex, profitable mines. Professional mining engineers recognized a difference between prospect adits and production-class tunnels. Height and width were the primary defining criteria. A production-class tunnel was wide enough to permit an outgoing ore car to pass an ingoing miner, with headroom for compressed air lines and ventilation tubing. Some mining engineers defined production-class tunnels as being at least 3½' to 4' wide and 6' to 6½' high, and anything smaller, they claimed, was merely a prospect adit.²⁶²

Miners paid due attention to the tunnel portal because it guarded against cave-ins of loose rock and soil. Experienced miners recognized *cap-and-post timber sets* as best suited for supporting both the portal and areas of fractured rock further in. This universal interior structure consisted of two upright posts and a cross-member assembled with precision using measuring rules and carpentry tools. Miners cut square notches into the timbers, nailed the cap to the tops of the posts, and raised the set into place. Afterward, the miners hammered wooden wedges between the cap and the tunnel ceiling to make the set weight-bearing. Because a tunnel usually penetrated zones of loose soil and fractured rock, a series of cap-and-post sets were required to resist the ground, and they had to be lined with lagging to fend off loose material. In areas of swelling ground, the bottoms of the posts were secured to a floor-level cross-timber or log footer to prevent them from being pushed inward. Because wood in wet ground decayed quickly, the timbering had to be replaced as often as several times a year. Professionally trained mining

²⁶¹ Twitty, Eric *Reading the Ruins: A Field Guide for Interpreting the Remains of Western Hardrock Mines* Masters Thesis (Denver: University of Colorado, 1999): 30-2.

²⁶² Peele, 1918: 459; Young, George *Elements of Mining* (New York: John Wiley & Sons, 1923): 463.

engineers claimed that dimension lumber was best because it decayed slowly and was easy to frame, but high costs discouraged its use where logs were available.²⁶³

Mine Transportation

Miners working underground generated tons of waste rock that had to be hauled out, while tools, timbers, and explosives had to be brought in. As a result, both prospect operations and large, paying mines had to rely on some form of a transportation system. The conveyances used by prospectors had to be inexpensive, adaptable to tight workings, and capable of being carried into the backcountry. To meet these needs, prospect outfits often used wheelbarrows on plank runways. Mining engineers recognized the functionality of wheelbarrows but classified them as strictly serving the needs of subsurface prospecting because of their light duty.²⁶⁴

Outfits driving substantial underground workings required a vehicle with greater capacity, choosing the ore car, which ran on a baby-gauge track. The typical car featured a wooden or plate iron body approximately 2' high, 4' long, and 2½' wide, holding around one ton of rock. The body pivoted on a turntable riveted to a rail truck and had a swing gate at the front, allowing the operator to dump a load of rock on either side of or at the end of the rail line.

Ore cars ran on rails sold by mine supply houses in standard sizes. Units of measure were based on the rail's weight-per-yard. Light-duty rail ranged from 6 to 12 pounds per yard, medium-duty ranged from 12, 16, 18, or 20 pounds per yard, and heavy rail started at 24 pounds per yard. Prospecting outfits usually purchased light-duty rail because of its transportability and low cost. Mining engineers erecting production-class transportation systems used medium-duty rail or better because it lasted longer.²⁶⁵

The specifics of a rail system reflected the experience and judgment of management, financial status of the company, and extent of the underground workings. The basic system used in nearly all Colorado mines consisted of a main line extending from areas of work underground, though the surface plant, and out to the waste rock dump. Productive mines and deep prospect operations usually had spurs underground extending to tunnel faces, stopes, and ore bin stations. Substantial mines with extensive surface plants also featured spurs on ground-surface extending to different parts of the waste rock dump, a storage area, and the mine shop. Many large mines built special stake-side, flatbed, and latrine cars for the coordinated movement of specific materials and wastes.

Mining outfits understood that hand-tramming single-ore cars was the most cost-effective locomotion at small and medium-sized operations. But at large mines, many used draft animals to pull trains of two to five cars. As mining matured through the nineteenth century, miners learned that mules were well-suited because they were reliable, strong, of even temperament, and intelligent. The electric locomotive, termed an *electric mule* by some miners, arrived in the west during the 1890s. The early machines consisted of a trolley car motor custom-mounted onto a steel chassis, and they took their power from overhead *trolley lines* strung along the mine's ceiling. The spread of electric mules to the I-70 corridor proved slow. Locomotives required special mechanical and electrical engineering, were too big for the tortuous workings of most mines, and required considerable capital. A small locomotive cost \$1,500 and \$7.50 per day to

²⁶³ International Textbook Company, 1899: A40-42.

²⁶⁴ Twitty, 2002: 36.

²⁶⁵ International Textbook Company, 1899: A40, 53; Young, 1923: 192.

operate. A mule, on the other hand, cost only \$150 to \$300 to purchase and house, and between \$.60 and \$1.25 to feed and care for per day.²⁶⁶

Upgrades to the rail line presented the engineer with additional costs. Mules were able to draw between three and five ore cars weighing approximately 2,500 pounds each, for which 16-pound rails spiked at an 18" gauge proved adequate. But electric locomotives and their trains usually weighed dozens of tons, thus requiring broad tracks of heavier rail. Mining engineers recommended tracks of 20-pound rail spiked 24" apart on ties spaced every 2' for small to medium-sized locomotives. Heavy locomotives required rail up to 40-pounds per yard spiked at 36" gauge. The reason for the heavy rails and closely spaced ties was that the machines pressed down on the track and perpetually worked uphill against the downward-flexed rails, wasting much of the locomotive's power and energy.²⁶⁷

Some mining engineers criticized the fact that electric locomotives were tied to the fixed route defined by trolley wires. To remedy this, electric machinery makers introduced the storage battery locomotive around 1900, which traveled freely over mine's rail lines. A few mining engineers espoused the compressed air locomotive, consisting of a compressed air tank fastened to a miniature steam locomotive chassis. These locomotives were able to negotiate tight passageways, had plenty of motive power, spread fresh air wherever they went, operated on the ubiquitous 18" rail gauge, and did not need complex electrical circuitry. They did, however, cost as much as their electric cousins and required a costly compressor capable of recharging the tank. Locomotives and the necessary improvements were well beyond the financial means of most mining outfits in the I-70 corridor, which continued the tradition of pushing single cars by hand.

The Mine Shop

Every mine required a blacksmith who maintained and fabricated equipment, tools, and hardware. The common rate for driving a tunnel with hand-drills and dynamite in hard rock was approximately 1' to 3' per 10-hour shift. Over the course of such a day, miners blunted drill-steels in substantial quantities, and for this reason, the blacksmith's primary duty was sharpening those steels.²⁶⁸

To permit the blacksmith to work in foul weather, mining companies erected buildings to shelter the shop. The building tended to be small, simple, and rough, and operations lacking capital often relied on local building materials such as logs. Prospecting and mining outfits almost invariably located the shop adjacent to the tunnel portal or shaft collar to minimize unnecessary handling (see Illustration B 1.7).

In general, blacksmiths required few tools but much skill for their work. A typical basic field shop consisted of a forge, bellows or blower, anvil, quenching tank, hammers, tongs, swage, cutter, chisels, hacksaw, snips, small drill, workbench, iron stock, hardware, and basic woodworking tools (see Illustrations A 1.4.3 and A 1.4.4). Prior to the 1910s, outfits deep in the backcountry often dispensed with factory-made forges and used local building materials to make vernacular versions. The most popular custom-made forge consisted of a gravel-filled, dry-laid

²⁶⁶ General Electric Company, *Electric Mine Locomotives: Catalogue No. 1045* (Chicago: General Electric Power and Mining Department, 1904) 23; Peele, 1918: 862, 871.

²⁶⁷ Colliery Engineer Company, *Coal Miners' Pocketbook* (New York: McGraw-Hill Book Co., 1916): 767; International Textbook Company, *International Library of Technology: Hoisting, Haulage, Mine Drainage* (Scranton: International Textbook Company, 1906): A55, 6; International Textbook Company, *International Correspondence School Reference Library: Rock Boring, Rock Drilling, Explosives and Blasting, Coal-Cutting Machinery, Timbering, Timber Trees, Trackwork* (Scranton: International Textbook Company, 1907): A48, 2; International Textbook Company, *Mine Haulage: Rope Haulage in Coal Mines, Locomotive Haulage in Coal Mines, Mine Haulage Systems, Calculations, and Cars* (Scranton: International Textbook Company, 1926) 1; Young, 1923: 192.

²⁶⁸ Hoover, Herbert C. *Principles of Mining* (New York: McGraw-Hill Book Co., 1909) 150; International Textbook Company, 1907:A48, 13; Peele, 1918: 184; Young, 1946: 87.

rock enclosure usually 3' by 3' in area and 2' high, and miners in forested regions substituted small logs. A tuyere, often made of a 2' length of pipe with a hole punched through the side, was carefully embedded in the gravel, and its function was to direct an air blast from the blower or bellows upward into the fire.

The size of a shop and its appliances were functions of capital, levels of ore production, and era. Shops at small mines typically featured a forge and blower in one corner of the building, an anvil and quenching tank next to the forge, a work bench with a vice along one of the walls, and a lathe and drill press. The appliances were usually manually operated.

Because medium-sized and large mines had greater materials handling needs, their shops were equipped with larger appliances, mechanized in some cases. Forges were typically either a 4' x 4' free-standing iron pan model, gravel-filled iron tank 4' in diameter, or 3' x 3' gravel-filled wood box. A greater availability and affordability of steam engines and air compressors during the 1890s brought power appliances within reach of many companies. Some installed power appliances such as lathes or drill presses. The most profitable mining companies equipped their shops with additional power appliances for advanced fabrication and machining. Appliances included a mechanical saw, grinder, and pipe threader, which may have been power-driven. The power hammer permitted a single blacksmith to complete the work of two. Well-capitalized companies installed factory-made models consisting of a heavy plate iron table and a piston hammer that pounded items with tremendous force. Those companies unwilling to buy factory-made hammers instead adapted heavily worn but operational rock drills. The drill was fixed onto a stout vertical timber, its chuck rapidly tapped an iron table.

The physical composure of a shop building reflects the financial state of a mining company. In general, the buildings were rough and vernacular in design and construction. Vernacular is defined as an adaptation of conventional forms and construction to the conditions, function, capital, and materials available to the mining outfit. The buildings were rarely designed by professional architects and instead were planned to meet specific needs. Outfits with limited financing used local building materials while well-capitalized mining companies often erected frame buildings. Two traits shared by most shops were windows for natural light and earthen floors to minimize the risk of fire started by loose embers.

Widespread embrace of compressed-air powered rock drills during the 1890s required blacksmiths to change their drill-steel sharpening methods. The noisy and greasy machines produced high volumes of dulled steels and broken fittings. Contrary to today's popular misconceptions, mining outfits in the I-70 corridor did not immediately adopt rock drills to bore blast-holes when introduced during the late 1870s. Instead, the conversion occurred over thirty years, and during the period, blacksmiths became proficient with both hand-steels and machine drill-steels, each of which had specific requirements.²⁶⁹

Between 1900 and 1910, equipment manufacturers introduced drill-steel sharpening machines to expedite the process. Early sharpeners, similar in appearance to horizontal lathes, were costly and thus few were employed. During the 1910s, however, rock drill makers introduced compact units standing on cast iron pedestals bolted to timber foundations. Well-financed mining companies installed the revised types with increased frequency through the 1910s. Most companies with limited funds, on the other hand, continued relying on traditional forge sharpening methods for decades afterward.

²⁶⁹ International Textbook Company, *International Library of Technology: Mine Surveying, Metal Mine Surveying, Mineral-Land Surveying, Steam and Steam Boilers, Steam Engines, Air Compression* (Scranton, International Textbook Company, 1924) A24, 1.

Mine Ventilation

The use of explosives, open flame lights, laboring miners' respiration, and natural gases often turned the underground atmosphere into an intolerably stifling and even poisonous environment. Mining outfits approached this problem by installing one or a combination of two basic ventilation systems. The first, *passive ventilation*, relied on natural air currents to remove foul air, but it proved marginal to ineffective in dead-end workings. *Mechanically assisted systems*, the second, were production-class in duty and required elementary engineering.

Some prospecting outfits cleverly combined passive and mechanical means. One of the simplest was a canvas windsock on a wooden pole, which drew air from breezes and directed it through canvas tubing or stovepipes into the underground workings. The drawback was poor performance on calm days. In another system, ordinary woodstoves drew foul air out of the workings through convection. The stove stood near the mine opening, with ventilation tubes extending into the underground workings. When a fire burned in the stove, the hot gases rising up the stovepipe created a vacuum in the ducting and siphoned foul air out of the mine.²⁷⁰

A few prospecting operations employed primitive mechanical systems for ventilation. These outfits used large forge bellows or small, hand-turned blowers to force air through stovepipes or canvas tubing. A bellows effectively ventilated shallow adits and shafts, but lacked pressure to clear gases from deep workings. Hand-turned blowers cost more money and took greater effort to pack to remote locations, but they forced foul air more surely from workings.

The simple windsocks and hand-turned blowers were insufficient for medium-sized and large mines, and engineers applied better methods. One of the most popular involved an *incast* air current balanced by an *outcast* current laden with the bad air. Multiple mine openings proved to be the most effective means of achieving a flushing current, and temperature and pressure differentials acted as driving forces.²⁷¹

Mechanical ventilation proved to be the most effective, but also was more expensive than passive systems. One of the most common and effective was the use of power-driven fans and blowers, in three basic varieties. Engineers termed the first design, dating to the 1870s, the *centrifugal fan*, and miners knew it as the *squirrel cage fan*. This machine consisted of a ring of vanes fixed to a central axle, much like a steamboat paddle wheel, enclosed in a shroud. As the fan turned at a high speed, it drew air in through an opening around the axle and blew it through a port in the shroud. Manufacturers produced centrifugal fans in sizes ranging from 1' to over 10' in diameter. The second type of fan also acted on centrifugal principles, but it consisted of a narrow ring of long vanes encased within a curvaceous cast-iron housing (see Illustrations A 1.4.5 and A 1.4.6). The *propeller fan*, the third type, was similar to the modern household fan, and it too was enclosed in a shroud.

Surface Plants for Shafts

Surface plants that supported work in shafts incorporated many of the same components as those for tunnels. However, due to the vertical nature of shafts, they also included hoisting systems, which had to meet specific engineering requirements. Typical systems installed in Clear Creek and Summit counties consisted of a hoist, headframe, power source, and hoisting vehicle.

²⁷⁰ Twitty, 1999: 51.

²⁷¹ International Textbook Company, 1899: A41, 133; International Textbook Company, *Coal and Metal Miners' Pocket Book* (Scranton: International Textbook Company, 1905) 381; Lewis, Robert S. *Elements of Mining* (New York: John Wiley & Sons, Inc., 1946 [1933]) 454; Peele, 1918: 1038; Young, 1923: 255.

As always, the financial state of the outfit, physical accessibility, and the quantity of proven ore governed the sophistication and cost.

Shaft Form and Hoisting Vehicles

Experienced prospectors and mining engineers recognized that crude prospect shafts were inadequate for anything other than a cursory examination of underground geology. Where a prospecting outfit strongly suspected or had confirmed the existence of ore, they sank a better, more formal shaft conducive to deep exploration and production. By the 1880s, mining engineers distinguished between temporary-class and production-class shafts.

Shaft size directly influenced the volume of ore hoisted out of the ground. Temporary-class shafts often featured one large compartment 3½' x 7' in-the-clear or less. During the 1880s, engineers established a standard for the composition of production-class shafts. Convention dictated dividing the interior into a *hoisting compartment* and *manway*, also known as a *utility compartment*, as well as guide rails in the hoisting compartment for a hoisting vehicle (see Illustration A 1.4.7). Further, mining engineers defined the hoisting compartment as being at least 4' x 4' in-the-clear. By the late nineteenth century, the definition expanded to suit larger vehicles, with a 4' x 5' compartment better suited for production, and 5' x 7' the best.²⁷²

Engineers also came to recognize the utility of balanced hoisting. Use of one hoisting vehicle to raise ore became known as *unbalanced hoisting*, and while this system was inefficient in production capacity and energy consumption, it was the least costly and hence most commonly employed. *Balanced hoisting* relied on two vehicles counterweighing each other, so that as one vehicle rose the other descended. The design required two hoisting compartments and a double-drum hoist, at considerable expense. But the hoist only had to do the work of lifting the ore, providing long-term savings through energy efficiency. Well-funded companies anticipating heavy production in Clear Creek County spared the expense and installed balanced systems.

Mining companies chose from four basic types of hoisting vehicles. The first was an *ore bucket*, the second was an *ore bucket and crosshead*, the third a *cage*, and the last a *skip*. The ore bucket found great favor at prospects and small mines because its shape and features were well suited to primitive conditions. The typical ore bucket consisted of an egg-shaped body with convex sides permitting the vessel to glance off shaft walls without catching on obstructions. Manufacturers forged a loop into the bail to hold the hoist cable on center, and riveted a ring onto the bucket bottom so the vessel could be upended once on the surface (see Illustration 1.4.8).

Mining companies engaged in deep shaft sinking took great risks with ore buckets. To prevent the vessel from catching on shaft walls and emptying its contents onto miners below, some mining companies installed a hybrid ore bucket hooked to a frame running on guide rails the length of the shaft. The frame, known as a *crosshead*, held the ore bucket steady and provided miners with a platform to stand on, albeit dubious, during ascents and descents. Besides safety, another advantage was that miners working underground were able to switch empty buckets with full ones. Many small, poorly financed companies favored this type of hoisting vehicle because of its low cost. In any form, mining engineers considered ore buckets as temporary-class hoisting vehicles.

A mining industry institution for over 120 years, the cage consisted of a steel frame fitted with a deck for miners and rails for an ore car. Nearly all cages used in the corridor featured a

²⁷² Eaton, Lucien *Practical Mine Development & Equipment* (New York: McGraw-Hill Book Company, 1934) 13; International Textbook Company, 1905: 261; Peele, 1918: 251; Young, 1923: 171, 461.

stout cable attachment at top, a bonnet to fend off falling debris, and steel guides that ran on special fine-grained 4" x 4" hardwood rails. After a number of grizzly accidents in which hoist cables parted, machinery makers installed special safety-dogs designed to stop an undesired descent. Most dogs were toothed cams controlled by springs kept taut by the weight of the suspended cage. If the cable broke, the springs retracted, closing the cams onto the wood rails.

Cages proved highly economical because mining companies did not have to spend time manipulating ungainly ore buckets. When the cage stopped at a station underground, a miner merely pushed on an ore car, and when the cage was at the surface, another worker withdrew the car. But cages presented mining companies with several drawbacks. One of the biggest lay in boring a shaft with enough space not only for the cage, but also for timbering and guide rails.

Cornish mining engineers originally developed the skip for haulage in the inclined shafts of Michigan copper mines during the 1840s and 1850s, and they later became popular in Colorado. The skip consisted of a large iron or wood box on wheels that ran on a rail line. The vehicles had little deadweight, held much rock, and, because they ran on rails, could be raised quickly. Skips were lighter than cages, lacking the combined deadweight of the vehicle and ore car, resulting in energy savings. Skips also offered the benefit of being quickly filled and emptied, resulting in a rapid turnover of rock. Shortly after the turn-of-the-century, western mining companies began replacing cages with skips for use in vertical shafts. The change gained momentum slowly around 1900, accelerated during the 1910s, and by the 1930s most large and many medium-sized mines used skips.

Hoists

When either prospectors or mining companies sank a shaft, they had to install a hoist to raise material out of the underground workings. Like other surface plant components, hoists came in a wide range of sizes, types, and duties. Hoists designed for prospecting adhered to *sinking-class* characteristics, while hoists intended for ore production met *production-class* specifications. The *hand windlass* was the simplest form of sinking-class hoist, universal among prospectors for shallow work (see Illustration A 1.4.9). The windlass was a manually powered winch consisting of a spool made from a lathed log fitted with crank handles. Because the windlass wound by hand, its working depth was limited to approximately 100'. Prospectors sinking inclined shafts had the option of using what was termed a *geared windlass* or *crab winch*, offering a greater pulling power and depth capacity. Geared windlasses cost much less than other mechanical hoists and were small and light enough to be packed into the backcountry. The winch was not easily used at vertical shafts, however, because its frame had to be anchored onto a well-built timber structure.²⁷³

Table A 1.4.1: General Hoist Specifications: Type, Duty, and Foundation

Hoist Type	Hoist Class	Foundation Size	Foundation Footprint	Foundation Profile	Foundation Material
Hand Windlass	Shallow Sinking		Rectangular	Wood frame over shaft	Timber
Hand Winch	Shallow Sinking	3' x 3'	Square or Rectangular	Flat	Timber
Horse Whim: Malacate	Shallow	7' - 10'	Ovoid	Cable Reel Axle	Timber

²⁷³ Twitty, 2002:145.

	Sinking	diameter	Depression	Located in Pit	
Horse Whim: Horizontal Reel	Sinking	4' x 4'	Rectangular	Timber Footers in Depression	Timber
Horse Whim: Geared	Sinking	4' x 4'	Rectangular	Timber Footers in Depression	Timber
Steam Donkey	Sinking	Portable	Rectangular	None	None
Gasoline Donkey	Sinking	Portable	Rectangular	None	None
Single Drum Gasoline	Sinking	2.5' x 8' to 4' x 14.5'	Rectangular	Flat	Timber or Concrete
Single Drum Gasoline	Sinking	2.5' x 8' to 4' x 14.5'	T-Shaped	Flat	Timber or Concrete
Single-Drum Steam	Sinking	6' x 6' and smaller	Rectangular	Flat	Timber or Concrete
Single-Drum Steam	Light Production	6' x 6' to 7.5' x 10'	Square or Rectangular	Flat	Concrete or Masonry
Single-Drum Steam	Moderate Production	7.5' x 10' and larger	Rectangular	Irregular	Concrete or Masonry
Double-Drum Steam	Moderate Production	4' x 7' to 7' x 12'	Rectangular	Irregular	Concrete or Masonry
Double-Drum Steam	Heavy Production	7' x 12' and larger.	Rectangular	Irregular	Concrete and Masonry
Single-Drum Geared Electric	Sinking	5' x 6' and smaller	Square or Rectangular	Flat	Concrete
Single-Drum Geared Electric	Production	6' x 6' and larger	Square or Rectangular	Flat	Concrete
Single-Drum Direct Drive Electric	Production	5' x 6' and larger	Square or Rectangular	Flat	Concrete
Double-Drum Geared Electric	Heavy Production	6' x 12'	Rectangular	Irregular	Concrete
Double-Drum Direct Drive Electric	Heavy Production	6' x 12'	Rectangular	Irregular	Concrete

(Reproduced from Twitty, 2002: 319).

Prospect operations often worked at depths exceeding the limitations of windlasses, forcing them to install more advanced hoisting systems. The *horse whim* proved popular because it was relatively inexpensive, portable, and simple to install (see Illustration A 1.4.10). Through the 1860s, the mining industry accepted the horse whim as a state-of-the-art hoisting technology for both prospecting and ore production. But by the 1870s, practical steam hoists came of age, and the status accorded to horse whims began a downward trend. By around 1880, mining engineers felt that horse whims were well-suited for backcountry prospecting, but too slow and limited in lifting power for ore production. Regardless, corridor mining companies with little income continued using whims into the 1910s.

Prospect outfits could select from several types of horse whims. The simplest and oldest, christened by Latino miners as the *malacate* (mal-a-ca-tay), consisted of a horizontal wooden drum or reel directly turned by a draft animal (see Illustration A 1.4.11). Early malacates featured the drum, a stout iron axle, and bearings fastened onto both an overhead beam and a timber foundation. Prospectors usually positioned the drum to rotate in a shallow pit lined with either rockwork or wood planking. The cable extended from the drum through a shallow trench toward the shaft, passing through a pulley at the foot of the headframe, then up and over a sheave wheel at the headframe's top. The draft animal walked around the whim on a prepared track, and the prospectors usually laid a plank over the cable trench for the animal to walk across. The

controls consisted of brake and clutch levers mounted to the shaft collar, and connected to the apparatus by wood or iron linkages passing through the trench.²⁷⁴

Mining machinery makers offered factory-made horse whims that were sturdier and performed better than the older handmade units. The *horizontal reel horse whim* consisted of a spoked iron cable reel on a timber foundation embedded in the ground, and it performed like the malacate. These whims remained popular among prospect operations until around 1900. The *geared horse whim* appeared in Colorado during the 1880s, remaining popular into the 1910s. The machine consisted of a cable drum mounted vertically on a timber frame, and a beveled gear that transferred the motion from the draft animal's harness beam. Geared whims were faster, could lift more than horizontal reel models, and featured controls and cable arrangements like the other types. A horse whim required a headframe over the shaft, and the structures were small, simple, and temporary-class in duty. Prospectors favored a tripod, tetrapod, or a small four-post derrick that was just wide enough to straddle the shaft.²⁷⁵

Prospect operations working deep shafts began using steam hoists by around 1880. These systems required a relatively substantive infrastructure that had to be planned and engineered, and hence they were beyond the financial means of poorly financed outfits. Steam hoisting systems included a heavy hoist and boiler, cable, pipes, headframe, and foundations. The mining company also had to provide a reliable source of water and fuel for the boiler. After around 1880, the *geared single-drum duplex steam hoist*, known simply as single-drum steam hoist, was the most popular type (see Illustration A 1.4.12). These hoists became the ubiquitous workhorse for shaft mining and featured a cable drum, two steam cylinders flanking the drum, reduction gears, clutch, brake mechanism, and throttle. Donkey hoists, specifically designed for prospecting, featured all the machinery on a steel chassis (see Illustration A 1.4.13).

Mining engineers selected the specific model and size of hoist primarily according to budget and secondarily on speed and anticipated depth of the workings. Nearly all sinking-class hoists had bedplates smaller than 6' x 6' in area and were driven either by gearing or by a friction-drive mechanism. A friction drive consisted of rubber rollers that pressed against the hoist's drum flanges, and while these systems cost less than geared hoists, they were slow and apt to slip under load. The sinking-class hoists had strength often less than 40 horsepower, a slow speed of 350' per minute, and a payload of only several tons. Regardless, many mining companies used these hoists for ore production.²⁷⁶

Steam equipment presented two sets of problems for outfits working deep in the backcountry. Not only did the outfits have to haul and erect the hoisting system, but also continuously fed it fuel and water, which was costly. In the early 1890s, the Witte Iron Works Company and the Weber Gas & Gasoline Engine Company both developed practical petroleum engine hoists, alleviating these issues. The innovative machines were smaller than many steam models, required no boilers, and their concentrated liquid fuel was by far easier to transport than wood or coal (see Illustration A 1.4.14).

Despite the potential advantages of petroleum hoists, mining companies in corridor did not immediately embrace the apparatuses. Steam technology, the workhorse of the Industrial Revolution, held convention in the mining industry into the 1910s for several reasons. First, many mining companies were by nature conservative and continued with steam out of familiarity. Second, petroleum engine technology was relatively new and not yet widely used, especially for hoisting. The outfits employing petroleum hoists during the 1890s found the

²⁷⁴ Twitty, 2002: 161.

²⁷⁵ Twitty, 2002: 162.

²⁷⁶ Twitty, 2002: 319.

engines to be cantankerous and their performances limited. Further, petroleum hoists were slow with speeds of 300' to 400' per minute, had lifting capacities of at most 4,500 pounds, and were restricted to working depths less than 1,000'. For these reasons, professional mining engineers felt the hoists were barely adequate for sinking duty, and total acceptance took approximately fifteen years.²⁷⁷

The petroleum hoists available to the corridor's mining outfits were similar in form to old-fashioned steam donkey hoists. A large, single-cylinder engine was fixed to the rear of a heavy cast-iron frame and its piston rod was connected to a heavy crankshaft in the frame's center. Manufacturers located the cable drum, turned by reduction gearing, at the front, and the hoistman stood to one side and operated the controls. Because the early petroleum engines were incapable of starting and stopping under load, they had to run continuously, requiring the hoistman to delicately work the clutch when hoisting and to disengage the drum and lower the ore bucket via the brake.

For production-class hoists, steam technology maintained supremacy into the 1920s, when electric motors were finally advanced enough. Machinery manufacturers offered production-class steam hoists in a wide array of sizes, as well as with *first-motion* or *second motion* drive trains. First-motion drive, also known as *direct-drive*, meant that the steam engine's drive rods were coupled directly onto the cable drum axle, like how the drive rods were directly pinned onto the wheels of a steam locomotive (see Illustrations A 1.4.16 and A 1.4.17). Second-motion, also known as a *geared-drive*, consisted of reduction gearing like the sinking-class hoists discussed above.

The difference in the driving mechanisms was significant in both performance and cost, and each served a distinct function. Gearing offered great mechanical advantage, permitting the use of small steam cylinders and a compact footprint. First-motion hoists, on the other hand, required the cable drum be mounted at the ends of large steam cylinders so the drive rods could gain leverage. Where the footprint of geared hoists was almost square, the footprint of first-motion hoists was that of an elongated rectangle oriented toward the shaft. First-motion hoists were high-quality production-class machines saving money over protracted and constant use. Geared hoists were intended to be inexpensive and meet the short-term needs of modestly capitalized mines. They were not as strong, fast, or fuel-efficient. The large size, high-quality steel, and the fine engines made the cost of first-motion hoists three to four times that of geared hoists, costing from approximately \$1,000 to \$3,000 for light to heavy models. First-motion hoists had speeds of 1,500' to 3,000' per minute, compared with 500' to 700' per minute for geared hoists. Geared hoists usually relied on old-fashioned but durable slide valve engines, while first-motion hoists usually were equipped with Corliss valves engines, which consumed half the fuel.²⁷⁸

While the costs of purchasing first-motion hoists were high, so were the installation expenses. Because geared hoists were self-contained on a common bedplate, the construction crew merely had to build a simple foundation with anchor bolts and drop the hoist into place. First-motion hoists, on the other hand, required raised masonry pylons for the steam cylinders and the cable drum bearings, a well for the drum, and anchor bolts for the brake posts. The hoist pieces then had to be maneuvered into place and simultaneously assembled.

Mining engineers chose specific hoists for the power they delivered, proportionally relative to the hoist's overall size. Geared hoists smaller than 6' x 6' were for deep exploration and delivered less than 40 horsepower. Hoists between 7' x 7' and 9' x 9' were for minor ore

²⁷⁷ Twitty, 2002: 173.

²⁷⁸ Twitty, 2002: 199-201.

production and offered 75 to 100 horsepower. Hoists 10' x 10' to 11' x 11' were for moderate production and generated up to 150 horsepower, and larger units were exclusively for heavy production. Mining engineers rarely installed geared hoists larger than 12' x 12', because for a little more money, they could have obtained an efficient first-motion model.²⁷⁹

Regardless of the drive mechanism, single-drum hoists were restricted to shafts with single hoisting compartments, with their inherent inefficiencies. Double-drum hoists, on the other hand, offered greater performance by increasing production while saving energy costs. They achieved this through balanced hoisting as discussed above. However, double-drum hoists possessed several drawbacks that limited their appeal to particularly well-financed mining companies. The hoists were considerably more expensive than single-drum models, and sinking and timbering a shaft with two hoisting compartments constituted a great cost.

Like single-drum hoists, double-drum units came with geared or first-motion drives. Geared models, ranging in size from 7' x 12' to 12' x 17', were slower, less powerful, and noisier than their direct-drive brethren, but cost much less (see Illustrations A 1.4.18 and A 1.4.19). The ultimate answer for maximum production in minimal time was a double-drum, first-motion hoist. This type ranged in size from approximately 18' x 25' to over 30' x 40' in area, and its visual impact mirrored its performance. The extreme difficulty and exorbitant costs of transporting and installing these massive machines relegated them to only the most heavily capitalized mining companies. Not only did these hoists permit mining companies to maximize production, but also they served as a statement of a company's financial status, levels of productivity, and quality of engineering (see Illustration A 1.4.20).

As early as around 1895, a handful of mining companies in Clear Creek County experimented with electric hoists for work underground. By 1900, electric hoists also saw greater use on the surface, as well. Like steam hoists, electric models came in four basic varieties: geared single and double-drum units, and direct-drive single and double-drum units. The geared electric hoists were much like their steam ancestors (see Illustrations A 1.4.21 and A 1.4.22). The gearing permitted hoist manufacturers to install small and inexpensive motors ranging from 30 to 300 horsepower. Direct-drive electric hoists, on the other hand, had huge motors rated up to 2,000 horsepower attached to the same shaft as the cable drums.²⁸⁰

As with steam hoists, mining engineers classified single-drum electric hoists smaller than 6' x 6' in area as sinking-class in duty. Most production-class hoists featured motors rated to at least 60 horsepower for single-drum units and 100 horsepower for double-drum units. Even with large motors, these geared hoists had slow speeds of less than 600' per minute, a limited payload capacity, and were unable to work in the deepest shafts.²⁸¹

During the capital-scarce Great Depression, many mining companies had to settle for small, slow, sinking-class hoists out of economic necessity. These companies used hoists with motors rated at only 15 horsepower, which in better times might have been used for light work underground. Some outfits cobbled together hoists from machinery cast off during earlier decades. Miners exercised creativity in reusing obsolete machinery, and their solutions fell into several basic patterns. One common method involved obtaining an old, geared steam hoist, stripping the steam equipment, and adapting an electric motor. Another clever means was to leave the steam equipment intact and substituted compressed air for steam to power the hoist. The only drawback was that a costly, multistage compressor had to supply the air. In some cases, impoverished mining operations were able to contract with neighboring companies that

²⁷⁹ Twitty, 2002: 320.

²⁸⁰ Eaton, 1934: 86, 295; Lewis, 1946: 187; William Staley, *Mine Plant Design* (New York: McGraw-Hill Book Co., 1936) 137; Young, 1946: 203; E.N. Zurn, *Coal Miners' Pocketbook* (New York: McGraw-Hill Book Co., 1928): 760.

²⁸¹ Twitty, 1999: 341.

possessed the necessary compressors for the air. A third practice was to assemble hoists from odd pieces of machinery. A favorite system involved coupling a small hoist, stripped of everything but the brake and clutch, to the power train of a salvaged automobile engine. Slow, noisy, and of questionable reliability, these contraptions allowed many mining operations to turn a small profit. Lacking the money and knowledge of how to construct a proper foundation, miners simply bolted the hoist and salvaged engine to a flimsy timber frame not necessarily anchored in the ground.²⁸²

Some small and medium-sized mining outfits were able to afford factory-made gasoline hoists during the Great Depression. Mining companies continued to use the old single-cylinder gasoline hoists, or purchased factory-made donkey hoists offered by machinery suppliers such as Fairbanks-Morse and the Mine & Smelter Supply Company. The donkey hoist manufactured during the 1930s consisted of a small automobile engine that turned a cable drum through reduction gearing. The makers designed the little machines to be portable, and they affixed all of the components onto a steel frame.

Few shaft mines in either Clear Creek or Summit County retain their hoists and instead feature the foundations, which are distinct. By examining the footprint of a foundation, the researcher can often determine the exact type of hoist. Foundations for production-class *single-drum steam hoists* and *single-drum electric hoists* tend to be slightly rectangular and flat, feature at least six anchor bolts around the outside, and usually consist of concrete or masonry. Foundations greater than 8' x 8' in area may feature a depressed center that once accommodated a large cable drum. Foundations for *double-drum geared steam hoists* tend to possess an elongated rectangular footprint oriented 90 degrees to the shaft. They usually consist of concrete or masonry, feature a perimeter of anchor bolts, and include wells for the cable drums. Small anchor bolts on the edges of the drum wells often braced brake shoes.

Double-drum geared electric hoists were bolted to foundations similar to those for their steam-driven counterparts. The principal difference manifests as a separate mount for the electric motor, which is often rectangular, less than 4' x 5' in area, featuring four anchor bolts.

Direct-drive hoists were usually bolted to complex foundations that anchored the machines' individual components. The foundation usually consists of two parallel masonry footers capped with dressed sandstone or granite blocks. The blocks toward the rear supported the steam cylinders and those toward the front supported the cable drum's bearings. Single-drum hoists required one depressed well between the footers for the cable drum, and double-drum hoists required two wells. In addition, a masonry pylon stood between the wells to support the drum axle. Foundations for single-drum hoists are rarely larger than 14' x 19' in area, and those for double-drum hoists are greater.²⁸³

Steam Boilers

Boilers were necessary components of steam-powered hoisting systems. While specific boiler designs evolved and improved over time, the basic principle and function remained unchanged. Boilers were iron vessels in which intense heat converted large volumes of water into steam under great pressure. Such specialized devices had to be constructed of heavy boilerplate iron riveted to exacting specifications, and they had to arrive at the mine ready for neglect and abuse. The problem boilers presented was that they were bulky, heavy, cumbersome, and required engineering to install.

²⁸² Twitty, 1999: 341, 343.

²⁸³ Twitty, 2002: 240.

During the 1870s, the *Pennsylvania boiler*, *locomotive boiler*, and *upright boiler*, also known as the *vertical boiler*, quickly gained popularity among Clear Creek drainage prospect operations (see Illustrations A 1.4.23-A 1.4.25). These boilers were well-suited to difficult geographic and physical environment because they were self-contained and freestanding, ready to fire, and able to withstand mistreatment. Because the three types boilers were designed to be portable at the expense of efficiency, mining engineers declared them fit only for sinking duty.

In general, the above boilers consisted of a shell that contained water, flue tubes extending through the shell, a firebox inside the shell at one end, and a smoke manifold. When the fireman stoked a fire in the firebox, he adjusted the dampers to admit enough oxygen to bring the flames to a steady roar. The flue gases, which were superheated, flowed from the fire through the flue tubes, imparting their energy to the surrounding water, and they flowed out the smoke manifold and up the smokestack.

The boiler front featured a glass sight-tube much like the level indicator on a coffee urn so the fireman could measure the water level. Boiler tenders usually kept the boiler three-quarters full, the empty space being necessary for steam to gather. When the fire grew low, the boiler tender opened the fire door, the upper of two cast-iron hatches, and threw in fuel. Mining engineers recognized that cord wood was the most appropriate fuel in remote and undeveloped areas because importing coal was too expensive. However, coal was the most energy-efficient, a half ton equaling the heat generated by a cord of wood, mining operations proximal to commercial centers thus preferring it.

During the 1880s, mining companies came to appreciate the utility and horsepower of the locomotive boiler, so named because railroad engine manufacturers favored it. The boiler consisted of a horizontal shell with a firebox in one end and a smokestack projecting out the other end. Nearly all models stood on wood skids and were easily portable, but some required a masonry pad underneath the firebox and a masonry pillar supporting the other end. Locomotive boilers were usually 10' to 16' long, 3' in diameter, and stood up to around 6' high, not including the steam dome on top. These workhorses, the single most popular sinking-class source of steam into the 1910s, typically generated from 30 to 50 horsepower, enough to run a hoist.²⁸⁴

Upright boilers were the least costly of all models. They tolerated abuse well and were the most portable, but were highly inefficient and could not generate much horsepower. Upright boilers consisted of a vertical water shell that stood over a firebox and ash pit integral with a cast-iron base. The flue tubes extended upward through the shell, opening into a smoke chamber enclosed by a hood and smokestack. Upright boilers required little floor space or maintenance, and were so durable that they almost could be rolled from site to site. Plenty of remote prospect operations saw great advantage in vertical boilers, and consequently these steam generators enjoyed substantial popularity into the 1910s.²⁸⁵

The third sinking-class boiler widely used was the Pennsylvania model. This unit combined the form and portability of the locomotive boiler with the function of the Scotch marine boiler, discussed below. Like the other portable boilers, the Pennsylvania featured an enclosed firebox surrounded by a jacket of water. The flue gases traveled through tubes in the shell, rose into a small smoke chamber at the rear, reversed direction, traveled toward the front

²⁸⁴ Twitty, 1999: 204.

²⁸⁵ Croft, Terrell *Steam Boilers* (New York: McGraw-Hill Book Co., 1921) 48; International Textbook Company, 1899: A18, 34; Kleinhans, Frank B. *Locomotive Boiler Construction* (New York: Norman W. Henley Publishing Co., 1915) 12; Rand Drill Company, *Illustrated Catalogue of the Rand Drill Company, New York, U.S.A.* (New York: Rand Drill Company, 1886) 47; Tinney, W.H. *Gold Mining Machinery: Its Selection, Arrangement, & Installation* (New York: D. Van Nostrand Company, 1906) 50.

through more tubes, and escaped through a smokestack. The Pennsylvania boiler, which originated in the Keystone state's oil fields, proved to be remarkably efficient.²⁸⁶

Developed in Scotland for maritime purposes, the Scotch marine boiler was the least popular sinking-class steam generator. Scotch marine boilers consisted of a large-diameter shell enclosing the firebox, and the path for the flue gases was similar to that of the Pennsylvania boiler. While this type of boiler was one of the most efficient portable units, it never became popular because convention dictated the use of other types, and it was heavy, large, and difficult to haul to remote locations.²⁸⁷

Engineers designing production-class surface plants rarely relied on portable boilers because of their inefficiency. Rather, engineers predominantly used *return-tube boilers* in masonry settings, or *water-tube boilers* for ultimate fuel economy. The concept and design behind the return-tube boiler was innovative (see Illustrations A 1.4.26 and A 1.4.27). The boiler shell, part of a complex structure, was suspended from legs known as *buckstaves*, so named because they prevented the associated masonry walls from bucking outward. The masonry walls enclosed an area underneath the boiler shell, and a heavy iron façade shrouded the front. A firebox and ash pit lay behind the façade, both sealed behind heavy cast-iron doors. When a fire burned, superheated flue gases traveled from the firebox along the belly of the boiler shell and rose up into a smoke chamber at the rear of the structure. They reversed direction, traveling toward the front through large flue tubes extending through the shell, and then exited through the smoke manifold. The path under and then back through the boiler shell offered the flue gases every opportunity to transfer energy to the water within and convert it into steam.

Return-tube boilers were workhorses that withstood the harsh treatment and neglect typical of the mining industry. However, boiler tenders administered to a few basic details to avoid accidental death, disastrous explosions or ruptures. First, they had to keep the boiler at least two-thirds full of water. Second, the firemen had to clean ashes out of the ash pit regularly to prevent the fire from suffocating. Third, they verified that the water and steam valves were operational and that the pressure did not exceed the critical point. Last, the firemen had to feed the fire. Skilled individuals added just enough fuel in an even distribution to keep the fire a fairly constant glow. To ensure that boiler tenders had easy access to plenty of coal, the mining engineer usually had a coal bin built facing the firebox doors. In other circumstances cordwood may have been stacked in the bin's place.

Mining companies with plenty of capital installed additional devices to improve the energy efficiency and performance of their boilers. Some arranged feed-water tanks to allow sediment and mineralization to settle out. Others installed feed-water heaters, small heat exchangers that used some of the boiler's hot water or steam to preheat the fresh water. These moderated the shock of temperature changes to the boiler, prolonging the vessel's life and increasing fuel efficiency. A few engineers working at the largest mines automated the input of coal with mechanical stokers. Engineers also fitted heavily stoked boilers with rocking or shaking grates that sifted the ashes downward, promoting better combustion. Last, companies wrapped the heater, steam pipes, and exposed parts of the boiler with horsehair or asbestos plaster as insulation.²⁸⁸

At the time when boiler technology was nascent, in 1856 an American inventor named Wilcox devised a boiler radically different and more efficient than the best return-tube models.

²⁸⁶ Twitty, 1999: 206.

²⁸⁷ Colliery Engineer Company, 1893: 262; International Textbook Company, 1899: A18, 28; Peele, 1918: 2083; Thurston, R.H. *A Manual of Steam Boilers: Their Design, Construction, and Operation* (New York: John Wiley & Sons, 1901) 31.

²⁸⁸ Ihlseng, Magnus *A Manual of Mining* (New York: John Wiley & Sons, 1892): 581; International Textbook Company, 1924: A23, 53; *The Mining Catalog: 1925 Metal-Quarry Edition* (Keystone Consolidated Publishing Company Inc., 1925) 115; Peele, 1918: 2086.

Wilcox's system consisted of a large brick vault capped with several horizontal, iron water tanks and an assemblage of fifty to sixty water-filled iron tubes. The vault contained a firebox, ash pit, and smoke chamber. The tubes drew water from one end of the tanks and sent the resultant steam to the other end. By 1870, the design, known as the *water-tube boiler*, had been commercialized and manufactured by the firm Babcock & Wilcox.²⁸⁹

After Babcock & Wilcox's water-tube boiler had proven itself in industrial applications, mining engineers began taking interest. The fact that the water ran through the tubes and not around them greatly increased the liquid's heating area, resulting in greater efficiency. In addition, the threat of a catastrophic explosion was almost nonexistent. By the 1890s, a number of mechanical engineers had devised other water-tube boilers, such as the Heine, Sterling, Wickes, Hazelton, and Harrisburg-Starr.

The problem with all of the above models, however, was that they required much more attention than the rugged return-tube boilers, were significantly more costly, and were beyond the understanding and field skills of average mining engineers. As a result, water-tube boilers saw use only at large, well-capitalized mines under the supervision of professionally trained engineers. As the prices of water-tube boilers fell during the 1890s and capital became abundant following the Silver Crash of 1893, their popularity grew, but the embrace of electricity in the 1910s prevented widespread adoption.

Headframes

Nearly all the mechanical hoisting systems built in Clear Creek and Summit counties included a headframe over the shaft. The purpose was to support and guide the hoist cable and assist the transfer of rock from and supplies into the hoisting vehicle. Professionally educated engineers recognized six basic forms of headframes, including the tripod and tetrapod used with horse whims, as well as the two-post gallows, four and six-post derricks, and the A-frame (see Illustrationss A 1.4.28-A 1.4.30).

The *two-post gallows* was one of the most common headframes, and engineers agreed it was best for prospecting. The variety used by small operations consisted of two upright posts, cap timber, another cross-member several feet below, and diagonal back braces, all standing at most 25' high. The cap timber and lower cross-member held the sheave wheel in place. The gallows portion of the structure stood on one end of a timber foundation equal in length to the headframe's height. The diagonal backbraces extended from the posts down toward the hoist, where they were tied into the foundation footers. The foundation, made of parallel timbers held together with cross- members, rested on the ground and straddled the shaft collar. The four-post derrick erected for prospecting was similar in height, construction, and materials, featuring four posts instead of two and stood on a timber foundation. The A-frame was based on the same design as the two-post gallows. The difference was that the A-frame featured fore and aft diagonal braces to buttress the structure in both directions. A-frames were not erected directly over inclined shafts and instead were placed between the hoist and shaft so that the angle of the cable extending upward from the hoist equaled that extending down the shaft.

²⁸⁹ Croft, 1921: 18, 53; Horace Greeley, Leon Case, et. al., "Babcock and Wilcox Boiler," *The Great Industries of the United States* (Hartford: J.B. Burr.; International Textbook Company, 1872, 1899) A18, 35; Linstrom, C.B. and Clemens, A.B. *Steam Boilers and Equipment* (Scranton: International Textbook Co., 1928) 30; Peele, 1918: 2083; Thurston, 1901: 34; Tinney, 1906: 63.

Table A 1.4.2: Headframe Specifications: Type, Material, Class

Headframe Type	Material	Class	Capital Investment
Tripod	Hewn Logs	Sinking	Very Low
Tripod	Light Timber	Sinking	Very Low
Two Post (Gallows Frame): Small	Timber	Sinking	Low
Two Post (Gallows Frame): Large	Timber	Production	Low to Moderate
Two Post (Gallows Frame): Large	Steel	Production	Moderate to High
Four Post: Small	Light Timber	Sinking	Low
Four Post	Timber	Production	Moderate
Six Post	Timber	Production	Moderate to High
Four and Six Post	Steel	Production	High
A-Frame	Timber	Production	Moderate to High
A-Frame	Steel	Production	High

(Reproduced from Twitty, 1999: 281)

The common features shared by the above structures included small size, simplicity, minimal materials, ease of erection, and portability. For comparison, a two-post gallows frame 20' high cost as little as \$50 and a slightly larger structure \$150, while a production-class A-frame cost \$650 and a production-class, four-post derrick headframe up to \$900.²⁹⁰

When designing sinking-class headframes, the mining engineer had to consider three basic stresses. First was live load, created by the weight of a full hoist vehicle and cable. Second was braking load, a surge of force created when the hoistman quickly brought a vehicle to a halt in the shaft. Third was the horizontal pull of the hoist. To counter these forces, mining engineers often built their headframes with 8' x 8' timbers and installed diagonal back braces to counter the pull of the hoist. Usually, carpenters assembled the primary components with mortise-and-tenon joints, 1" diameter iron tie rods, and timber-bolts. Professionally trained engineers specified that diagonal back braces were most effective when bisecting a vertical angle and the diagonal pitch of the hoist cable. When a mining engineer attempted to find the mathematically perfect location for a hoist after erecting a headframe, he merely measured the distance from the shaft to the diagonal brace, doubled the length, and installed the hoist. Many prospect operations followed this general guideline, but poorly educated engineers gave the diagonal braces either too much or too little angle.²⁹¹

Production-class headframes were more complex than sinking-class versions, and designing them was rigorous. Mining engineers accounted for a variety of stresses, consider the structure's multiple functions, and coordinate the structure with other hoisting system components. The structure had to withstand immense dead load, live load, and braking load. Engineers also calculated horizontal forces including the powerful pull of the hoist and windshear, which could not be underestimated in the mountains. Last, mining engineers had to plan for racking and swaying under loads and for vibration and shocks to the structure.²⁹²

Building a headframe that could endure these forces was still not enough at a producing mine. Mining engineers had to forecast how they thought the headframe would interact with the mine's production goals and how it would interface with the rest of the hoisting system. The depth of the shaft, the speed of the hoist, and the rail system at the mine directly influenced the height of the structure. Deep shafts served by fast hoists required tall headframes, usually higher

²⁹⁰ Twitty, 1999: 215.

²⁹¹ Twitty, 1999: 215.

²⁹² Ihseng, 1892: 91; International Textbook Company, 1899: A23, 105; International Textbook Company, 1906: A53, 31; Ketchum, Milo S. *The Design of Mine Structures* (New York: McGraw-Hill Book Co., 1912) 41; Peele, 1918: 926; Twitty, 1999: 274.

than 50', to allow the hoistman room to stop the hoisting vehicle before slamming into the top. Highly productive mining operations often utilized vertical space by constructing multiple shaft landings or rock pockets for skips, all requiring height.

Mining engineers found four basic headframe designs adequate for heavy ore production. These included the *four-post derrick*, the *six-post derrick*, an *A-frame* known also as the *California frame*, and a heavily braced, two-post structure known as the *Montana type*. As the names suggest, engineers working in specific regions in the West favored certain headframe designs over others. While the above structures were intended to serve vertical shafts, two-post gallows headframes and a variety of A-frames up to 35' high were also erected to serve inclined shafts.²⁹³

Production-class headframes, weighing dozens of tons, required sound and substantial foundations to remain stable. A preplanned and well-built foundation was one factor defining the structures, and engineers used one of three basic designs. The first was a squat timber cube with bottom sills, timber posts, and caps. The second consisted of several log cribbing cells assembled with notches and forged iron spikes, and the third was a log or timber latticework of open cubes between 4' and 6' high, capped with dimension timbers. The problem with the above foundations was that the perishable wood rotted when covered with waste rock, especially when the rock was highly mineralized. Well-financed companies substituted concrete or rock masonry to gain a lasting foundation.²⁹⁴

In the 1890s, the largest mining companies began experimenting with steel girders for headframes as an alternative to timber. According to prominent mining engineers, steel was the ultimate building material because it did not decay, was strong, did not burn, and facilitated the erection of taller headframes. However, steel was significantly more expensive than timber, and as a result, few companies put up such structures.

Mining operations that were active during and after the Great Depression had the same needs for headframes as their predecessors. Most Depression-era outfits attempted to reuse existing headframes to save capital, and in such cases, merely made necessary repairs. If the mine lacked its original headframe, then the outfit had to erect another one, and the replacement structures differed according to the outfit's nature.

Large mining companies continued the practice of building four and six-post derricks and A-frames and still considered steel to be the ultimate material. But by the 1930s, a certain element of construction quality and workmanship had been lost. Workers no longer took the trouble to assemble the structure with mortise-and-tenon joints. Instead, they simply butted the timbers against each other or created shallow square notch joints and bolted the frame together.

Impoverished outfits with neither the funding nor the means to build substantial structures instead assembled small headframes designed function while incorporating little material. When possible, these mining companies relocated entire headframes. By nature, the headframes tended to be old sinking-class two-post gallows or four-post derrick structures because they were simple, easy to transport, and required no professional engineering.

One practice that many mining companies shared during the Great Depression was an extensive use of salvaged timbers. Stout timbers were a precious and costly commodity, and in hopes of saving capital, mining companies reused the heavy beams left by abandoned operations. As a result, headframes remaining from the 1930s and afterward may feature timbers differing in dimensions, weathering, and quality of wood. In addition, salvaged timbers frequently exhibit

²⁹³ Twitty, 1999: 275.

²⁹⁴ Twitty, 1999: 283.

abandoned mortise-and-tenon joint sockets, and bolt and nail holes. The heavy use of such material for headframes, as well as for other structures, is typical of Depression-era structures.

Additional Surface Plant Components

The above descriptions of tunnel and shaft mines account for basic surface plant components. Productive mining companies often installed additional facilities enhancing their ability to increase production and sustain work underground. The following components were characteristic of both types of mines.

Air Compressors

Blasting was of supreme importance to mining because it was the prime mover of rock underground. During the nineteenth century, miners traditionally drilled holes by hand, loaded them with explosives, and fired rounds. Hand-drilling proved slow, but no practical alternative existed to take its place until machinery manufacturers began selling mechanical rock drills during the 1870s. When drilling by hand, miners typically advanced tunnels and shafts only 1' to 3' per shift in hard rock. By contrast, the mechanical rock drills offered during the 1880s and 1890s bored greater numbers of deeper holes, advancing a tunnel or shaft approximately 3' to 7' per shift. As drilling technology improved between 1890 and 1900, miners were able to make even greater progress, convincing engineers that the relatively high cost was justified. Some of the early drills were powered by steam plumbed to the point of work, but the majority were driven by compressed air, generated and distributed through an engineered system.²⁹⁵

The air compressor lay at the system's heart, and while those manufactured between the 1880s and 1920s came in a variety of shapes and sizes, they all operated according to a basic premise. Compressors of this era consisted of at least one relatively large cylinder, much like a steam engine, which pushed air through valves into plumbing connected to an air receiving tank. The volume of air that a compressor delivered, measured as *cubic feet of air per minute* (cfm), depended on the cylinder's diameter and stroke, and how fast the machine operated. The pressure capacity, measured as *pounds per square inch* (psi), depended on the above qualities, how stout the machine was, and on check-valves in the plumbing. Generally, high-pressure, high-volume compressors were large, strong, durable, complex, and therefore expensive.

The mechanical workings of the air compressors manufactured prior to around 1890 were relatively simple. The two most popular types were *steam-driven straight-line* and the *steam-driven duplex* models, and both were a basis for designs that served the mining industry well for over sixty years. The straight-line compressor, named after its physical configuration, was the least expensive, oldest, and most elemental of the two types. Straight-line compressors were structurally based on the horizontal steam engine, featuring a large compression cylinder at one end, a heavy cast-iron flywheel at the opposite end, and a steam cylinder situated in the middle, all bolted to a cast-iron bedplate. The steam cylinder powered the machine, and the flywheel provided momentum and smoothed the motion (see Illustrations A 1.4.31-A 1.4.34).

During the 1870s and early 1880s, mechanical engineers improved many of the inefficiencies attributed to early straight-line models. First, engineers modified the compression cylinder to make it double-acting, much like a butter churn. In this design, which became standard, the compression piston was at work in both directions of travel, being pushed one way

²⁹⁵ Gillette, Halbert P. *Rock Excavation: Methods and Cost* (New York: Myron C. Clark Publishing Company, 1907) 15; Hoover, 1909: 150; International Correspondence Schools, 1907: 13; Peele, 1918: 184, 213; Young, 1946: 87.

by the steam piston and dragged back the other way by the spinning flywheel. In so doing the compression piston devoted 100 percent of its motion to compressing air.

During the early 1880s, mechanical engineers innovated several improvements. Engineers found that coupling the compression piston to the steam piston with a solid rod, so that both acted in tandem, proved highly inefficient. The steam piston was at its maximum pushing power when it was just beginning its stroke, and the compression piston, also beginning its stroke, offered the least resistance. When the steam piston had expended its energy and reached the end of its stroke, the compression piston offered the greatest resistance because the air in the cylinder had reached maximum compaction. Mechanical engineers recognized this wasteful imbalance and designed an intermediary crankshaft that reversed the relationship between the pistons. Despite the superior efficiency of this design, mining companies usually selected the simpler compressors with solid shafting because they cost less.

During the late 1880s and early 1890s, mining engineers fine-tuned compressed air technology used for mining. The most significant advance was a design that generated greater air pressure, which made drills run faster and improved the pressurization of the maze-like networks of plumbing. Machinery makers began offering straight-line and duplex compressors capable of achieving what the industry termed *multi-stage compression*. To increase pressure, mechanical engineers divided the compression between high and low-pressure cylinders in several stages, instead of in a single cylinder. They designed the low-pressure cylinder to be relatively large, forcing semi-compressed air into the small, high-pressure cylinder, which further compressed the air and released it into a receiving tank.

Machinery makers designed multi-stage, straight-line compressors with two and even three compression cylinders, and they produced duplex compressors with several multi-stage cylinder arrangements. The most common multistage duplex compressor was the *cross-compound* arrangement, in which one side of the machine featured the low-pressure cylinder, and the air passed from it through an intercooler to the high-pressure cylinder on the other side. In general, companies with heavy air needs installed multi-stage compressors while operations with limited capital continued to rely on the less costly, conventional models.

At the turn-of-the-century, machinery makers began offering compressors that were smaller, more efficient, and provided better service than early models. They adapted several designs to be run by electric motors and gasoline engines, energy sources well-suited to remote mines. Gasoline and electric compressors underwent gradual acceptance, but proved their worth by the 1910s, and mining companies throughout the corridor embraced them.

By the late 1890s, mining machinery makers offered three basic types of electric compressors, including a straight-line machine that was approximately the same size as traditional steam versions, a small straight-line unit, and a duplex compressor. Duplex models, conducive to multi-stage compression, were most popular among medium-sized and large mining companies, while moderately sized mining operations favored the small straight-line units. Due to limited air output compared with a relatively large floor space, the large, electric, straight-line compressors never became popular (see Illustrations A 1.4.35-A 1.4.36).

Table A 1.4.3: Air Compressor Specifications: Type, Timeframe, and Capital Investment

Compressor Type	Age Range	Capital Investment
Upright: 2 Cylinders, Belt Driven	1900-1940s	Low
Upright: 3 to 4 Cylinders, Integral Gasoline Piston	1930s-Present	Moderate
V Pattern	1930s-Present	Moderate to High
Straight-Line, Single Stage, Gasoline Engine Driven	1910-1930s	Low
Straight-Line, Single Stage, Steam Driven	1880s-1920s	Moderate
Straight-Line, Two Stage, Steam Driven	1890s-1920s	High
Straight-Line, Triple Stage, Steam Driven	1890s-1920s	Very High
Straight-Line, Single Stage, Geared to Electric Motor	1900-1920s	Moderate
Straight-Line, Various Stages, Geared to Electric Motor	1900-1920s	High
Straight-Line, Single Stage, Belt Driven by Electric Motor	1900-1940s	Low
Duplex, Single Stage, Steam Driven	1890s-1920s	Moderate
Duplex, Two Stage, Steam Driven	1890s-1920s	High
Duplex, Triple Stage, Steam Driven	1890s-1920s	Very High
Duplex, Two Stage, Belt Driven	1900-1940s	Moderate
Duplex, Three Stage, Belt Driven	1900-1940s	Moderate to High

(Adapted from Twitty, 2002: 306).

Compressor makers also developed economical gasoline units ideal for remote operations. The gasoline compressor, introduced in practical form in the late 1890s, consisted of a straight-line compression cylinder linked to a single-cylinder gas engine. Most mining engineers considered gas compressors to be for sinking duty only. Large gasoline machines were capable of producing up to 300 cubic feet of air at 90 pounds per square inch, enough to run up to four small rock drills (see Illustration A 1.4.37).²⁹⁶

The noisy gasoline machines had needs similar to their steam-driven cousins. Gasoline compressors required cooling, fuel, and a substantial foundation capable of withstanding intense vibration. They came from the factory either assembled or in large components for transportation into the backcountry. The cooling system often consisted of no more than a water tank, and the fuel system could have been simply a large sheet iron fuel tank connected to the engine by ¼” to ½” inch metal tubing. Motor-driven duplex and straight-line compressors dominated mining operations through the 1940s. Well-financed mining companies requiring high volumes of air at high pressures continued to favor belt-driven duplex compressors, while companies with slightly reduced air needs relied on relatively inexpensive, single-stage, belt-drive, straight-line compressors.

Compressed air technology underwent dynamic changes during the 1910s, when mechanical engineers introduced unconventional designs for commercial production. The *upright two-cylinder compressor* was based on the automobile engine, featuring similar valves and a crankshaft. Used on an experimental basis as early as the turn-of-the-century, these units were ideal for prospects and small mines, being inexpensive, adaptable to any form of power, and portable, especially when mounted them onto four-wheel trailers or simple wood frames. *V-cylinder compressors*, also known as *feather valve compressors*, adapted from truck engine design, featured three to eight cylinders arranged in a V configuration, with a grossly enlarged radiator for cooling. An electric motor directly coupled onto the crankshaft, a gasoline engine, provided power (see Illustrations A 1.4.38 and A 1.4.39).

²⁹⁶ Twitty, 1999: 126.

In most cases, when a mine was abandoned its compressor was removed, leaving only the foundation. As with hoists, the researcher can often determine the exact type of compressor based on footprint. Following are descriptions of foundations for common compressors. *Straight-line steam units* usually stood on foundations with a rectangular footprint and flat top studded with two rows of anchor bolts. In general, workers used masonry or concrete, bolting some machines less than 12' long to timbers. Foundations for large versions often featured individual blocks for the steam and compression cylinders and a separate pedestal adjacent to one end for an outboard flywheel bearing.

Foundations for large, early *duplex steam compressors* consisted of a pair of elongated rectangular pads spaced several feet apart. The pads were usually mirror opposites, including anchor bolts, and masonry or concrete in construction. The steam and compression cylinders and flywheel were bolted to their own sets of blocks. The foundations for compact duplex compressors are easily identified today. The foundations are U-shaped, slightly rectangular, and several feet high. Units powered by a motor had a small pad at the open end of the U.

Straight-line belt-driven compressors were bolted to foundations similar to those for their steam-driven counterparts. They also featured a separate pedestal at one end for the flywheel's outboard bearing, and a second, rectangular foundation for the drive motor.

Due to severe vibrations, *petroleum compressors* were usually bolted to stout, concrete foundations several feet high. The foundations are almost always rectangular, several feet wide, less than 9' long, with two rows of anchor bolts. *Upright compressors*, small in size, could have been bolted to either timber or concrete foundations rectangular in footprint. A pad for the engine or motor should be adjacent and aligned.

Foundations for *V-cylinder compressors* tend to be distinct, featuring aligned mount for a motor or engine. Compressors that had several cylinders were bolted to rectangular foundations between 3' x 3' and 4' x 5' in area, while versions with numerous cylinders were several feet wide and up to 10' long. In construction, the foundations had a series of closely spaced timbers bolted to either an underlying concrete pad or buried timber footer.

Electricity

Mining engineers in the west began experimenting with electricity as early as 1881. Clear Creek County, on the leading edge, was home to one of the earliest electrical projects in the Rocky Mountain west. In 1882 or 1883, the Kohinoor & Donaldson Consolidated Mining Company installed a generator at the Kohinoor Mine and provided service to Lawson. At that time, electric technology was new and its practical application was limited primarily to lighting. During the 1880s, visionary inventors demonstrated that electricity was able to do mechanical work as well.²⁹⁷

During the late 1880s and early 1890s, profitable and well-capitalized companies in technologically advanced areas, including western Clear Creek County, attempted to turn their curiosity into mechanical use. They made their first attempts to run machinery in locations featuring a combination of water and topographical relief conducive to hydro-power. In 1887, the Electric Light Company at Georgetown built a hydro-plant to provide lighting. In 1890, the Georgetown Electric Company built a second facility and expanded service specifically for mining in 1892. Colorado, including Clear Creek County, continued to be a proving ground for the development of electricity through the 1890s. Engineers foresaw electricity as an alternative

²⁹⁷ Twitty, Eric "From Steam Engines to Electric Motors: Electrification in the Cripple Creek Mining District," *The Mining History Journal* (1998): 103.

to steam. If electricity could be generated at a central point and transmitted to remote mines, then coal and steam equipment would not have to be packed up to those mines, and this was quite costly. Inherent limitations in electrical technology, however, retarded its immediate embrace.

The earliest electrical circuits were energized with direct current (DC), which had a unidirectional flow. At the same time, mining engineers also experimented with alternating, or oscillating, current (AC). Neither power source as they existed during early the 1890s was particularly well suited for mining. AC current could be transmitted for miles with little energy loss, but AC motors were incapable of starting or stopping under load. Therefore, AC was unsuitable for running hoists, large shop appliances, or other machines that experienced sudden drag or required variable speed. AC electricity was effective, however, for running small air compressors, ventilation fans, and other constant-rotation machines that offered little resistance. DC electricity, on the other hand, had the capacity to start and stop machinery under load, but the electric current could not be transmitted distance without suffering debilitating power loss. Therefore DC current had to be used adjacent to its point of generation. In addition, DC motors were incapable of running the massive production-class machines that mining companies had come to rely on for profitable ore extraction.²⁹⁸

Based on the above, contemporary electrical technology offered mining companies little incentive to retire their steam equipment. However, progressive engineers conducted extensive experimentation during the early 1890s to harness both DC and AC currents. Around 1900, electrical appliance manufacturers made several breakthroughs that rendered the power source useful for mining. Electricians developed the three-phase AC motor, which could start and stop under load while using current that could be transmitted long distances. They also invented DC/AC converters, permitting the use of DC motors on the distribution end of an AC electric line. The net result was that electricity became an attractive power source to a broad range of consumers. Still, many mining companies were not yet willing to relinquish traditional steam technology completely. Voltage, amperage, and current had not yet been standardized among machinery manufacturers or various power generators. As such, the prevailing attitude was cautious.²⁹⁹

The rigors of mine hoisting proved to be a major obstacle, but by the turn-of-the-century machinery manufacturers developed a variety of small AC and DC hoists that were reasonably reliable. The early electric models were similar in design to sinking-class geared steam hoists and were manufactured with motors wholesaled from electric appliance companies such as General Electric. Even though electric hoists were able to start and stop under load, they remained slow with limited payload capacity.³⁰⁰

By the 1910s, engineering progressed to the point where mining companies could not deny that electric equipment performed as well as steam. When steam machines became worn, mining companies replaced them with electric models. One engineer asserted that where power was readily available, a steam-driven compressor cost up to \$100 per horsepower per year to run while an electric model cost only \$50. During the 1910s, engineers and manufacturers improved performance and reliability, and introduced double-drum units for balanced hoisting. By 1920, except for remote and poorly capitalized operations, most companies adopted electric power.³⁰¹

²⁹⁸ International Textbook Company, 1899: A23, 5; Peele, 1918: 1126; Twitty, 1998.

²⁹⁹ Twitty, 1999: 269.

³⁰⁰ Twitty, 1999:270.

³⁰¹ Twitty, 1999:270.

Mine Architecture

Once a mining company had proven the existence of ore, investors expected the operation to perform throughout the year, until the ore had been exhausted. Complying with company wishes, engineers erected buildings to shelter surface plant components and work areas against the weather. The engineer also had a tacit understanding that mine buildings possessed the ability to inspire investors. Large, well-built buildings such the shaft houses on Seaton Mountain above Idaho Springs, for example, conveyed permanence, wealth, and industrial might.

Functional layout, design, and construction materials for mine buildings in the corridor evolved between the 1870s and the 1920s. Most were vernacular expressions unique to each mining operation. Professional architects rarely designed these buildings, although both professional and self-actualized engineers often proved capable builders despite formal training in architecture. They successfully adapted construction methods to the terrain, climate, transportation limitations, financial resources, and available materials. In many cases, engineers imitated mining industry architecture elsewhere, molding it to fulfill a particular need in a localized context (see Illustrations A 1.4.40 and A 1.4.41).

Mining engineers considered four basic expenditures influencing type, size, and composition of buildings. These included the time necessary to design the building, and the cost to purchase or fabricate basic construction materials. Third, was hauling materials to the site, and fourth, the cost of construction itself. During the 1860s and 1870s, many operations relied heavily on logs because they were readily available at little cost. Walls were usually assembled with saddle, square, or V-notch joints, and gaps chinked with sand or mud retained by split strips. From the 1870s through turn of the century, companies fulfilled need by erecting frame buildings sided with lumber. Buildings erected by well-financed companies tended to be substantial and well-built, while those of operations with poor capitalization were crude, small, and rough.

The introduction of steel and iron materials to the mining industry in the 1890s changed some buildings. Steel makers began selling corrugated siding for commercial construction in the 1890s, and while much was decorative, some varieties were designed with industrial applications in mind. Corrugated sheet metal particularly found favor in the mining industry and its use spread rapidly, becoming ubiquitous for siding by the 1910s. The advantages of corrugated sheet metal were its affordability, light weight (and thus ease of shipping), ability to cover a substantial area, and rigidity. These qualities made corrugated sheet metal ideal where remoteness rendered lumber too costly.³⁰²

The other significant use of metal in mine buildings occurred around 1900 when a few prominent companies began experimenting with girders for framing large buildings. Architects began using steel framing to support commercial and industrial brick and stone masonry buildings as early as the 1880s, but mining companies in general found that wood framing met their needs for less money. By the 1890s, architectural steelwork had improved and steel makers offered lightweight beams, which mining engineers adapted to large mine buildings. Further, engineers found that steel offered a sound structure resistant to high winds, but also often cost less than the thousands of board-feet of lumber required to erect massive buildings. The use of steel in the I-70 corridor is a subject worthy of further research.

The general types, forms, and designs of mine buildings followed a few patterns, regardless of materials. Between the 1870s and 1910s, most engineers enclosed primary surface plant components clustered around a shaft in a multi-purpose *shaft house*, and the plant

³⁰² Twitty, 1999: 304.

components associated with a tunnel in a *tunnel house*. These buildings contained machinery, the shop, mine entrance, and workspace. Smaller shaft houses in Clear Creek and Summit counties were often constructed of wood framing, gabled rafter roofs, and unsubstantial foundations. Larger shaft houses were based on custom-designed frames of heavy timbers capable of supporting the roof independent of the walls (see Illustration A 1.4.42). Regardless of frame design, carpenters clad the walls with board-and-batten siding, several layers of boards, and, by 1900, corrugated metal siding. Even after electric lighting was available, engineers continued to design large multi-pane windows at regular intervals for daylight.

Most shaft houses conformed to a few standard footprints influenced by the arrangement of machinery. Overall, the buildings tended to be rectilinear to encompass the hoist, anchored some distance from the shaft, with lateral extensions for the shop, water tank, boilers, and either coal or cord wood storage. Professional engineers recommended that at least the boiler, and ideally the shop as well, be partitioned in separate rooms because they generated unpleasant soot and dust which took a toll on lubricated machinery.³⁰³

The roof profile of most shaft houses featured a louvered cupola enclosing the headframe's crown and a sloped extension descending toward the hoist to accommodate the hoist cable and headframe backbraces. Tall iron boiler smokestacks pierced the roof proximal to the hoist. The forge stovepipe extended through the roof near the shaft collar. The shaft house also sometimes featured other stove pipes at the hoistman's platform and carpentry shop. The tall smokestacks were usually guyed with baling wire against strong winds. The shaft houses at high elevations often had plank flooring to improve insulation. In some cases the shop and boiler areas, where workers dropped smoldering embers, hot pieces of metal, and nodules of fresh clinker were also floored with planking, despite fire hazard. Customarily the mining engineer designed the flooring flush with the top surfaces of the machine foundations, permitting steam and other pipes to be routed underneath.

By the late 1910s, the U.S. Bureau of Mines outlawed shaft houses made of flammable materials. Surface plants then changed, consisting of smaller, individual buildings surrounding an exposed headframe. Instead of a shaft house, mines featured *hoist houses* for the hoist, boilers, and shop (see Illustration 1.4.43). At large operations, individual buildings housed some surface plant components separately. The shop had its own building, as with the *compressor house* and electrical substation *transformer house*. The mine plant may have also featured a miner's *change house*, also known as a *dry*, a storage building, stable, and carpentry shop.

The difficult economic climate of the Great Depression changed general construction methods for mining architecture to some degree. Overall, the buildings became smaller, incorporated more salvaged materials, and were less well-built than in previous decades. These trends continued through mining's decline in the 1960s. Mining companies with capital erected buildings that were spacious with lofty, gabled roofs when possible. Engineers continued to take advantage of natural light and provided broad, custom-made doors at key functional points. Engineers either floored principal structures with poured Portland cement, inexpensive due in part to the proliferation of trucking, or used wood planking. Preferred materials included lumber, sheet iron, and factory-made hardware. In most cases, mining engineers emphasized function and economy in their designs with no superfluous ornamentation. Poorly funded outfits could not afford quality materials or tools, experienced engineers, or skilled workers. Many favored single-slope shed roofing with salvaged irregular doors and windows. Overall, these buildings assumed an ad-hoc quality, but were ultimately well-built and offered shelter. Some buildings lacked

³⁰³ Twitty, 1999: 306.

formal framing or were simple balloon-frame construction. Builders used a patchwork of planks and sheet metal for siding, often layered to prevent wind damage.

Ore Storage

Although capitalists, engineers, and miners often held differing opinions in running a mine, all were in agreement that the primary goal was the production of ore. Those mines with any measurable output usually featured an ore storage facility to accommodate production, and two basic types were typical in Clear Creek and Summit counties. *Ore bins* were functionally different from *ore sorting houses*, and mining companies based choice of structure on the type of ore being mined. Some ores were consistent in quality and rock type, warranting storage in an ore bin. Low-grade and complex ore required sorting, separation from waste rock, and rudimentary concentration in an ore sorting house. Both types of structures required a means of inputting ore from the mine and a means of extracting it for shipment to a mill for finer concentration.

Mining engineers recognized three basic types of ore bins: the *flat-bottom bin*, *sloped-floor bin*, and hybrid *compromise bin*. Mining companies with regular ore production often erected large sloped-floor ore bins. The solidity of these structures, costing more than twice to build than flat-bottomed bins, inspired confidence. Sloped-floor bins typically consisted of a heavy post-and-girt frame sided on the interior with planking, standing on foundations of heavy timber footers on terraces of waste rock. To ensure the structure's durability against the onslaught of sharp rock, laborers often armored bin floors with salvaged plate iron. Small mines used sloped-floor bins consisting of a single cell, while large mines erected structures with numerous cells to hold either different grades of ore, or batches of payrock produced by multiple companies of lessees working within the same mine.

Mining companies with limited financing and ore production erected flat-bottom bins because such structures were inexpensive while meeting needs. Rarely did these structures attain the proportions of their large sloped-floor cousins because the walls were not able to withstand the immense lateral pressures exerted by the ore. Flat-bottomed bins contended with pressure on all four walls, while sloped-floor bins directed the pressure against the front wall and diagonal floor. Flat-bottom bins also were seasonal because they could not be roofed.

Ore sorting houses were generally more complex than ore bins, requiring greater capital and engineering. The primary functions of ore sorting houses were rudimentary concentration and storage. In keeping with the gravity-flow engineering typical of mining, engineers usually designed sorting houses with multiple levels for input, processing, and storage. These structures usually featured a row of receiving bins or chutes on the top level, a sorting floor under the receiving bins, and a row of holding bins underneath the sorting floor. Receiving bins usually had sloped floors, and in most cases the holding bins did too. A cupola sheltered the top level, and the sorting floor was fully enclosed and heated with a wood stove. The holding bins at bottom were sloped, and the structure usually stood on a foundation of heavy timber pilings or log cribbing walls.³⁰⁴

The general processing path began when miners underground characterized the nature of the ore they were extracting. They communicated their assessment via a labeled stake, message on a discarded dynamite box panel, or tag placed in the ore car. A trammer then hauled the loaded car out of the mine and pushed it into the sorting house. He emptied the contents into one of several bins, depending on how impure the ore was. High-grade ore went into a small special

³⁰⁴ Twitty, 1999: 153.

bin at one end of the structure. Run-of-mine ore, which was not particularly rich but required no sorting, went into another bin at the opposite end. Low-grade payrock combined with waste rock, known as mixed ore, went into one of several bins located in the center of the ore sorting house. When released from the car, the mixed ore slid onto a heavy grate known as a *grizzly*. The rich portions of the ore fractured into fines, while the large cobbles that remained intact after blasting and shoveling contained waste rock that needed to be cobbled, or knocked off by surface laborers. The valuable fines dropped through the grizzly directly into the holding bins at the bottom of the structure, while the cobbles rolled off the grizzlies and into chutes that fed onto sorting tables. There, laborers worked to separate the ore from waste.

Explosives Magazines

Explosives were fundamental to mining as the prime mover of rock. Mining companies had to store enough dynamite and blasting powder to carry them through the weeks spanning freight deliveries, and they often informally stacked 50-pound boxes, the standard shipping container, in heavily used mine buildings or underground workings. Worse, during cold months, much of the year at high altitude, miners stored boxes of dynamite near boilers, in blacksmith shops, and near hoists where it remained in a thawed and ready state. Such storage practices were dangerous, and in response, some engineers instituted explosives magazines where storage could be carried out in a more controlled and orderly manner.

Well-built magazines came in a variety of forms and sizes, but all shared the common goal of concentrating and sheltering the mine's supply of explosives away from the main surface plant. Trained engineers felt that magazines should be bulletproof, fireproof, dry, and well-ventilated. Brick or concrete walls were best, or if frame construction, the walls needed to be sand-filled and sheathed with metal. Other magazines were similar to root cellars, consisting of a plank or masonry-lined chamber excavated out of a hillside, often 8' x 10' in area, and roofed with earth and rubble. Steel doors were advised. These features not only could protect explosives from physical threats, but regulate the interior environment. Extreme temperature fluctuations and pervasive moisture damaged fuse, blasting caps, blasting powder, and most forms of dynamite. This in turn directly impacted the miners' work environment, because degraded explosives created foul and poisonous gas byproducts that vitiated mine atmospheres. Regardless of degradation and obvious safety hazards, many small and medium-sized mining companies stored explosives in crude and even dangerous structures. Miners stored explosives in sheds sided only with corrugated sheet metal, in sheet metal boxes similar to doghouses, in earthen pits roofed with corrugated metal, or in abandoned prospect adits.

Aerial Tramways

Clear Creek County was known for its extreme vertical relief, and some of the best mines were difficult to access. Sheer cliffs, excessively steep slopes, heavy snowpack, and ragged bedrock confounded numerous attempts to establish roads negotiable by wagon. The aerial tramway was an ideal solution to the problem, and the county saw some of Colorado's earliest. In 1861, the brothers George and David Griffith erected what some believe was Colorado's first to lower ore from the Griffith Mine down to their mill at Georgetown. As can be expected of the era, the apparatus was simple, slow, and had a limited payload. Known as a *single-rope reversible tramway*, the system consisted of fixed line extended from the mine down to an unloading station below. A windlass at the mine wound a second cable that pulled a bucket up,

and when the bucket was full, a worker lowered it via hand brake. Although important for the time, the single-rope system was slow with a limited carrying capacity.³⁰⁵

Andrew S. Hallidie, a San Francisco engineer and mining machinery maker, was the first to develop a continuously operating tramway with a significant carrying capacity. In the late 1860s, he devised a system consisting of a series of wooden towers, a continuous loop of wire rope, and loading and unloading terminals at both ends. A procession of ore buckets fastened to the wire rope traveled a circuit between the stations. The system operated under gravity, and as the loaded buckets gently descended downslope, they pulled the light empty ones back up to the mine. The wire rope passed around large sheave wheels in the terminals, and in between coasted over idler wheels on timber cross-members, bolted to the towers. When empty buckets entered the top terminal, workers loaded them with payrock while the buckets were in motion. The buckets then passed around the sheave wheel and traveled down to the bottom terminal. When the buckets entered the bottom terminal, a guide rail upset them such that they dumped their contents into a receiving bin, and then returned to the top terminal (see Illustration A 1.4.44). Hallidie's design changed little from the 1870s, when mining companies began experimenting with it, until the 1890s when other designs came to dominate.

Although the Hallidie design was the best of its time for moving large volumes of ore, it had limitations. Theodore Otto and Adolph Bleichert, two German engineers, developed an alternative system introduced to Europe in 1874. The *Bleichert Double Rope* tramway utilized a *track rope* spanning from tower to tower, and a separate *traction rope* that tugged the ore buckets around the circuit. The track rope was fixed in place and served as a flexible rail, which the buckets coasted over on special hangers fitted with guide wheels. The traction rope attached to the bucket hanger via a mechanical clamp known as a *grip*. Like Hallidie Single Rope tramways, Bleichert Double Rope tramways incorporated top and bottom terminals where the buckets were filled and emptied, usually aided by gravity.³⁰⁶

The principal difference lay with the grip, which detached the traction rope. Workers could thus manually push the buckets around the interior of the terminal on suspended rails and fill them at leisure without spillage. The double-rope system also permitted the entire tramway circuit to be extended up to four miles in length and at almost any pitch. Given this, even though Bleichert systems were up to fifty percent more expensive than Hallidie tramways, they proved better for heavy production because of greater carrying capacity. Due to superior performance, Bleichert systems eclipsed the less expensive Hallidie tramways by the 1890s. Still, some companies with limited production and capital continued installing Hallidie systems after the turn of the century.

Designing and building aerial tramways were beyond the skills of most engineers because the systems were complex, requiring advanced economic and engineering calculations. Installation usually required at least some direction from technicians dispatched by the tramway maker. Although mining companies purchased standardized tramway equipment from manufacturers, rarely were two systems alike, in part because the physical and economic conditions of each mine were different.

Tramway systems were materials-intensive and required substantial structures. The basic components included a top terminal near the tunnel or shaft, a bottom terminal located adjacent to a road, railroad, or ore concentration mill, and a series of towers for the bucket line. Engineers developed four basic types of towers for both Bleichert and Hallidie systems. These included the *pyramid tower*, *braced hill tower*, *through tower*, and *composite tower*. The pyramid tower

³⁰⁵ *Georgetown Courier* 3/23/35 p1 c2.

³⁰⁶ Ihlseng, 1892: 138; International Textbook Company, 1905: 122; Lewis, 1946: 372; Peele, 1918: 1563; Trennert, Robert A. "From Gold Ore to Bat Guano: Aerial Tramways in the West," *The Mining History Journal* (1997): 6.

consisted of four upright legs that joined at the structure's crest. The through tower resembled an A-shaped headframe consisting of a wide, rectangular structure stabilized by fore and back-braces, the tram buckets passing through the framing. Composite towers usually had a truncated pyramid base topped with a smaller frame supporting a cross-member. The braced hill tower was similar to the through tower, except it had exaggerated diagonal braces tying it into the hill slope. Towers for both Bleichert and Hallidie systems required stout cross-members supporting the wire ropes. Hallidie systems, with their single-wire rope and fixed buckets, needed only one cross-member with several idler wheels or rollers, bolted to the top of the tower. Bleichert systems, on the other hand, required a stout cross-member at the tower top to support the stationary track cable, and a second cross-member 3' to 7' below to accommodate the moving traction rope. The second cross-member almost always featured either idler wheels or a broad, steel roller.

Tramway terminal design challenged engineers with integrating the system among the mine's surface plant. Terminals had to be physically arranged to permit the input and storage of tons of ore, facilitate the transfer of payrock into or out of the tram buckets, and resist the tremendous pull on the sheave wheel by the traction rope. In the case of Bleichert systems, terminals also anchored the track cables. For small-capacity tramways, engineers solved all the above problems within a single structure, while the terminals for large-capacity tramways required complex buildings.

Regardless of the type of tramway, the engineer had to design timber framing for the sheave wheel capable of resisting the tremendous horizontal forces of keeping the traction rope taut. The sheave in the top terminal rotated in a heavy timber framework anchored to bedrock and partially buried with waste rock ballast. In some designs, the wheel canted at the same angle as the pitch of the bucket line, so the cable did not derail, causing a potential catastrophe. With Bleichert systems, framing usually surrounded the sheave for maximum strength, unlike Hallidie systems. Because the buckets were fixed to the traction cable, they had to pass around the wheel, which meant the wheel had to be exposed on all but the front side. Typical sheave wheels, 6' in diameter for small systems and 12' for large systems, featured a deep, toothed groove for the rope, fixed onto a heavy steel axle set in cast-iron bearings bolted to the timbers. Brake levers, usually in both terminals, were typically very long to provide leverage, located adjacent to or on a catwalk immediately over the wheel. The lever controlled heavy wooden shoes pressing against a special flange fastened to the sheave wheel. At the bottom terminal, the sheave had to be moveable to take up slack in the bucket-line. In many cases, the wheel was fastened onto a heavy timber frame pulled backward by adjustable anchor cables or threaded steel rods.

Both Hallidie and Bleichert tramways were typically too large and expensive for smaller operations. Yet, rugged terrain and locations high on the sides of mountains presented no less of an access problem for these limited operations. In response, smaller companies erected *single-rope reversible* and *double-rope reversible* trams. Single-rope trams changed little from the Griffith's simple design, except a hoist at the mine wound the cable. Double-rope tramways, also known as *jig backs*, featured two fixed lines and two buckets that counter-balanced. A worker lowered a full bucket down to the bottom terminal with a hand brake, and it pulled the lighter, empty one up to the top terminal. Lengthy double-rope tramways often featured a series of towers similar to those for Bleichert systems.

Ore Beneficiation: Smelting, Ore Concentration, and Amalgamation

Mining was the first stage in a long process to convert ore into refined metals for consumption. When extracted from the ground crude ore required treatment to separate the metal

content from waste. The industry referred to the entire process as beneficiation, with numerous steps involved. The process was not straightforward because, in Clear Creek and Summit counties, nearly all forms of ore were highly complex blends of silver, zinc, lead, copper, and gold, and they strongly resisted treatment. This forced metallurgists to develop advanced chemical and mechanical processes. Ores of purity or simplicity, such as that mined early in Clear Creek, required few steps, while the complex ore required time-intensive treatment and numerous steps. In overview, the process began with crushing and grinding the ore, followed by separating metalliferous material from waste in a stage known as *concentration*. The resultant *concentrates* were roasted and smelted in a furnace, which furthered the separation and yielded a blend of metals known as *matte*. Advanced smelters located in Black Hawk, Denver, Golden, and the Midwest refined the matte into pure metals termed *bullion*.

A variety of facilities carried out one or all of the steps necessary to process crude ore. They operated either as independent mills or in conjunction with specific mines. *Smelters* were turnkey facilities that reduced crude ore to metals and matte, and a few operated in Clear Creek County. Unlike smelters, *concentration mills* did not reduce ore to matte, but instead, merely separated waste from ore metal content. *Amalgamation mills*, common in Clear Creek County but rare in Summit County, crushed gold ore and relied on mercury to amalgamate the gold.

Smelters

To produce metals, smelters incorporated mechanical, chemical, and roasting processes that a metallurgist tailored to an ore's general character. Basic smelting began when wagons delivered crude ore to the facility, which workers dumped into receiving bins at the smelter's head. The ore had to be broken into consistently sized cobbles either by hand or with a mechanical crusher and then loaded into the smelting furnace. If the ore contained high proportions of waste, it was concentrated with mechanical methods prior to smelting.

The furnace was at the heart of a smelter facility, and two general types saw use in Clear Creek County. The earliest, employed primarily at Georgetown during the late 1860s and early 1870s, was a masonry structure with a chamber for ore, ducts to direct blasts of hot gases against the ore, and fireboxes with special ventilation to enhance fuel combustion (see Illustration B 1.15). Troughs were supposed to collect molten liquid as it ran off the ore and segregate the metal content from slag according to specific gravity. Although little is known about exact design, they were generally patterned after lead smelters in Missouri and Wisconsin, and most failed with Clear Creek ore.

The successful furnaces were cylindrical steel vessels 4' to 12' in diameter and lined with fire bricks (see Illustration A 1.4.45). They stood on stout rock or brick masonry foundations and featured tap spouts and tuyeres, ports that admitted air blasts, at graduated intervals. At center was a columnar charge of fuel, and workers dumped crude ore around the column until the ore chamber was full. They usually admitted lead bullion, or lead or iron ore, first because the soft metal served as a flux, which, when molten, helped the rest of the ore liquefy. After workers arranged layers of ore, sealed the spouts, and added more fuel, they started a blower that fed air to the smoldering fire, bringing it to great heat.³⁰⁷

As the lead or iron ore melted and temperature increased, the liquid metals came in contact with harder metals and minerals, causing them to soften, melt, and trickle down into the base of the furnace. Over time, the lot of ore became molten and the heaviest material, usually

³⁰⁷ Lynn Bailey, *Shaft Furnaces and Beehive Kilns: A History of Smelting in the Far West, 1863-1900* (Tucson: Westernlore Press, 2002) 80; Meyerriecks, 2001:173.

the metals, settled to the bottom while the lighter waste floated on top. At this point, workers opened the upper slag spouts and tapped the liquid waste into slag carts, then did likewise with intermediate slag spouts. After they drew the waste off, the workers added more ore and fuel until the pool of liquid metal rose to the height of the lower slag spout. At this time, workers opened the lowest spout at the furnace base and tapped the molten metal into pots or molds until liquid slag made an appearance, indicating an end to the metal. Workers then repeated the process, keeping the furnace in continuous operation for days or weeks.³⁰⁸

Because metallurgists used gravity to draw ore through the processing stages when possible, they usually sited smelters at the base of a slope. Smelting facilities usually required flat space, a source of abundant water, and well-graded roads. In addition to the furnace, smelters often featured ore bins, large fuel bins, water tanks, storage, assay office, and vault. Each smelter usually had more than one furnace to process batches of ore simultaneously if the material was simple, or in stages if the ore was complex. Some smelters also featured roasters and mechanized concentration mills to prepare the ore and enhance separation prior to smelting.

Concentration Mills

Few mining companies possessed enough capital and ore to warrant a dedicated smelter. Most companies shipped their ores to custom smelters, which extracted the metals for a fee. The shipping charges and smelting fees often constituted considerable overhead, and in response, well-capitalized mining companies attempted to save money by building concentration mills near their workings. Concentration mills relied on mechanical and chemical processes to reduce ore, separate the metalliferous materials, and prepare the resultant concentrates for shipment to a smelter for final treatment. In so doing, mining companies accomplished many intermediate steps that smelters charged for and did not have to ship heavy crude ore. Concentration mills were not equipped, however, to produce finished bullion (see Illustration B 1.13).

Concentration mills were usually built over a series of terraces incised into a hillslope so gravity could draw the ore through the various processing stages (see Illustration A 1.4.46). Mills existed in a variety of sizes, and large facilities usually required stone masonry or concrete terraces, while earthen terraces and substantial beamwork were sufficient for small facilities. Large mills such as the Newton at Idaho Springs were heavily equipped to process both high volumes of ore, and complex ore that resisted simple treatment. To do so, they often provided primary, secondary, and even tertiary stages of crushing, screening, and concentration. Small mills, by contrast, usually provided crushing and concentration in a single linear path.

Engineers and metallurgists tended to follow a general pattern when designing concentration mills. An ore bin stood at the mill's head and fed crude ore into a *primary crusher*, usually located on the mill's top platform. The crusher reduced the material to gravel and cobbles ranging from 1" to 4" in diameter, which descended to a *secondary crusher* located on a platform below. The secondary crusher pulverized the ore to sand and slurry, to pass through a screening system. Oversized material returned for secondary crushing while the remainder passed on to concentration at smaller mills, or tertiary crushing followed by concentration at larger mills. By 1890, engineers favored *trommel screens* or *shaking screens* to sort the sand. A trommel consisted of a concentric series of cylindrical screens that rotated, allowing fine material to drop through while oversized cobbles rolled out of an open end. A shaking screen was a stack of rectangular pans with screen floors.³⁰⁹

³⁰⁸ Bailey, 2002:82-83; Meyerriecks, 2001:174.

³⁰⁹ Peele, 1918: 1623, 1627; Tinney, 1906: 191.

Machinery manufacturers offered a wide array of crushers and grinders, which metallurgists selected according to the ore's characteristics (see Illustrations A 1.4.47-A 1.4.54). Because no two mines featured the same ore and no two metallurgical assessments were alike, each mill was custom. However, engineers followed certain trends regarding the application of crushing machinery. *Jaw crushers*, also known as Blake crushers, provided primary crushing, while a few large operations employed gyratory crushers. Batteries of stamps were commonly employed for secondary crushing. A *stamp battery* consisted of a timber gallows frame with guides for heavy iron rods featuring cylindrical iron shoes. A cam lifted the rods in sequence and let them drop on the gravel being crushed. Crushing rolls often carried out secondary and tertiary crushing, and they consisted of a pair of heavy iron rollers similar to wheels in a stout timber frame. A narrow gap between the rollers drew in clasts of sand and gravel and fragmented them. *Grinding pans* and *Huntington mills* were used for tertiary crushing, and both featured a heavy cast-iron pan and iron shoes or rollers that dragged across the floor grinding the ore. When the ore was free-milling gold or silver, the metallurgist introduced mercury into the pan to amalgamate with the metals. *Tube mills* and *ball mills* offered the finest grinding. Each appliance consisted of a large cylinder that mill workers partially filled with sand, gravel, and water. The cylinder slowly rotated, and the iron rods in tube mills or iron balls in ball mills tumbled in the chamber, reducing the material to slurry. Both grinding appliances rose to popularity around 1900 and by the 1930s were used in place of crushing rolls and stamp batteries. The end product of crushing and grinding were *finer* and *slurry*.³¹⁰

Following another screening, ore descended to subsequent mill platforms for concentration. Several devices proved efficient at separating out metals, and most metallurgists assembled a concentration sequence involving more than one appliance (see Illustrations A 1.4.55-A 1.4.60). The *jig* relied on water currents and agitation to separate heavy metalliferous material and classify particles by size and weight. The jig consisted of a wooden trough, often 4' x 9' in area and 4' high, divided into cells that opened onto a V-shaped floor featuring valves and drains. Plungers agitated the slurry of ground ore in the cells, causing the heavy or large fines to settle while a gentle current of water washed the waste away. Jigs were highly popular from the late 1870s into the 1930s.

Vanners were a popular concentration appliance for silver and gold ores between the 1880s and 1905, until replaced by vibrating tables. A vanner featured a broad rubber belt on rollers mounted to an iron frame that vibrated. The belt assembly, around 5' x 15' in area, was suspended by an oscillating mechanism from a chassis bolted to a timber foundation. The belt moistened and as the machine vibrated, heavy metalliferous material settled against and stuck to the rubber while a jet of water washed off waste. As the belt wrapped down around one of the rollers, the metalliferous material dropped into a flume and proceeded for further concentration.³¹¹

Vibrating tables were one of the most effective classes of concentration appliances and rose to prominence around 1900. Arthur Wilfley designed the first model for his mill in Robinson, Colorado, in 1896. By the 1910s, metallurgists adapted the concept for nearly all types of metal ores. A vibrating table featured a tabletop, often 5' x 15' in area, clad with rubber or linoleum held down with fine riffles. The tabletop slanted on a mobile iron frame that rapidly oscillated, and the vigorous action caused heavy metalliferous material to settle against the

³¹⁰ Peele, 1918: 1630.

³¹¹ Lynn Bailey, *Shaft Furnaces and Beehive Kilns: A History of Smelting in the Far West, 1863-1900* (Tucson: Westernlore Press, 2002) 64, 112; Tinney, 1906: 204.

higher riffles while the waste worked its way downward. Water playing across the tabletop washed the waste away.³¹²

By the late 1910s, *flotation cells* were proving their worth and operated according to principals that seemed to defy traditional concentration technology. Flotation was pioneered in San Juan County in 1914, among other places in Colorado, and became common by the early 1920s. A flotation machine consisted of a large rectangular tank divided into cells filled with water and slurry. Oils or detergent were introduced and worked into a froth by compressed air agitators. In contrast to the above mechanical devices, the froth carried the metalliferous materials upward while wastes settled to the bottom of the cells. Revolving paddles then swept the metalliferous material into troughs.

While the above appliances were effective for silver and industrial metal ores, they were marginally effective on Clear Creek County's complex gold ores. Shortly after 1900, a few of the county's mining companies joined others in Cripple Creek and Boulder County in experimenting with *cyanidation* as an alternative. The ore was ground and concentrated as above, and then transferred into *cyanide tanks*, large wooden vats agitating the slurry in a dilute cyanide solution. The cyanide bonded with the gold, the waste was flumed out, and a worker tapped the solution into *precipitating boxes* where he introduced zinc, which cyanide preferred over gold. The chemical reaction caused the precious metal to precipitate out. Cyanide mills could have featured one or a series of cyanide tanks, depending on the purity and volume of ore.

Most mill processes liquefied slurry with water to mobilize the material and allay dust. However, at the end of the process, concentrates had to dry for shipment. Engineers installed various dewatering devices ranging from conical and pyramidal settling boxes to Dorr thickeners. Mill workers introduced slurries into settling boxes where the fines accumulated and exited through spigots in the bottom. The Dorr thickener, devised for high volumes of material, featured a tank at least 20' in diameter with a conical floor. Radial arms rotated slowly within the slurry and forced the fines toward the tank's center, where the material passed through a large spigot.³¹³

Gravity drew the metalliferous fines from one crushing and concentration stage to the next. However, each step also facilitated returning inferior material back for reprocessing, which often meant sending the material uphill. To accomplish this, metallurgists used either bucket-lines or spiral feeds. Bucket lines were a series of closely spaced sheet iron pans stitched to an endless canvas belt, scooping material from one bin and depositing it into another. Spiral feeds, effective for short distances, typically featured an auger that rotated in a sheet iron shroud. As the auger turned, it moved material upward and deposited it into a bin.

Concentration mills relied on the same power sources as mines, although the transition from steam to electricity at mills occurred slightly earlier (see Illustrations A 1.4.61-A 1.4.63). At most mills, a large horizontal steam engine drove various appliances through a system of overhead driveshafts and belts. Small upright units powered additional appliances at large mills. With electricity commonly available by the late 1890s, motors supplanted steam.

Amalgamation Stamp Mills

Two definitions apply to the term *stamp mill*. As noted above, concentration mills employed batteries of stamps to crush ore prior to other processing steps. In this case the term stamp mill refers to the stamp battery, a component of a concentration mill. Under the right

³¹² Peele, 1918: 1680; Tinney, 1906: 204.

³¹³ Peele, 1918: 1669.

mineralogical conditions, companies based an entire facility around a stamp battery to recover metals without smelting or advanced concentration. The ore had to feature relatively simple gold or silver compounds and be easily crushed. A jaw crusher usually provided primary crushing, while stamps further reduced the ore. Amalgamating tables at the battery's toe, coated with mercury, recovered the gold or silver. Workers periodically scraped off the amalgam and heated the mass in a retort, which volatilized the mercury and left the gold or silver.

Because stamp mills only required a fraction of the equipment installed at more complex concentration mills, they were smaller and simpler. Regardless, stamp mills shared a few fundamental aspects. First, due to the various stages of crushing and metals recovery, these facilities were also arranged on a series of platforms to use gravity to advantage. Second, stamp mills usually featured a receiving bin above the primary crusher to hold crude ore destined for processing. Third, the mid or lower platform housed the power source, often a horizontal steam engine and boiler. Last, the mill required a water source. Metallurgists often also installed tertiary crushing and a concentration appliance in some stamp mills to better prepare the ore for amalgamation. In such cases, the mill became an *amalgamation stamp mill*, a category applying to many mills in eastern Clear Creek County.

Arrastras

An arrastra was a simple and inexpensive, yet labor-intensive and inefficient means of recovering metals from ore. Arrastras primarily functioned during the first years of hardrock mining in Clear Creek County to treat simple gold ore (see Illustrations 1.4.64 and B 1.14). While a few capital-starved outfits continued employing the technology through the 1910s, the quick exhaustion of simple gold ore rendered these primitive treatment facilities obsolete by around 1870.

A typical arrastra featured a circular floor of carefully fitted stones, low sidewalls, and a capstan at center. They ranged in size from around 6' to 20' in diameter. A beam on the capstan's top rotated around the arrastra, dragging between one and twelve muller stones across the floor, depending on the arrastra's size. Usually the stones, chained to the beam, were staggered so they covered the floor's entire surface area. The floor stones had to possess flat faces and tight joints, while the mullers featured convex bottoms and iron hooks hammered tight into drill holes. The traditional Spanish arrastra relied on slave labor as motive power, which draft animals replaced. With the improvement of technology, scarcity of labor, and desire for increased production, in a few cases engineers harnessed waterpower and steam engines. The simplest form of arrastra cost around \$150 to build, much of which went to the labor for dressing and assembling the rockwork.³¹⁴

To build an arrastra, a worker leveled a platform, excavated a pit at center, and installed the capstan, which had to be stout enough to resist great horizontal force. The worker paved the platform with a layer of fine clay and carefully fitted the floor stones together using more clay as mortar. With the floor complete, he erected the sidewall, consisting either of more stonework or planks. During the twentieth century, concrete became a substitute for masonry. Once the beam and mullers were in place, the arrastra was ready for operation.³¹⁵

Running an arrastra required more skill and experience with local ores than engineering or formal metallurgy. First, a worker scattered a *charge* of ore across the arrastra's floor, completely covering the stones, and then introduced a little water. Then, the motive power began

³¹⁴ Meyerreicks, 2001: 194.

³¹⁵ Young, 1987: 69-71.

rotating the beam, dragging the mullers over the fragmented ore, slowly grinding it into sand. The worker periodically added more water to convert the material into a slurry, and sprinkled mercury into the mixture. The mullers continued reducing the ore into a combination of sand and fine particles known as *slimes*. The purpose of adding mercury was to create an amalgam with the metals as they became exposed by continued fracturing of the ore. Fine particles offered a greater surface area, facilitating amalgamation. Here, experience with local ores came into play, as the arrastra operator added enough mercury to form an amalgam paste, but not in excess, at peril of creating a liquid difficult to recover. Generally, one ounce of mercury recovered an equal amount of gold, or one pound of silver. In some cases, the operator added lye to bind with oils and grease, which interfered with amalgamation.³¹⁶

The next stage of ore processing was *cleanup*, where worthless *gangue* was removed and the amalgam recovered from the arrastra's interior. First, the operator drained the interior either by bailing, breaching the sidewall, or opening a port near the wall's base. The operator then shoveled the sand and slime out, leaving a mud and sand layer on the flooring stones. The operator carefully washed additional material out of the arrastra's interior, exposing as much of the amalgam smeared on the floor stones and deposited between the joints as possible. The operator next disassembled the floor stones, if small, and washed and scraped off the amalgam. Last, he filled a retort with the precious material and heated the vessel to volatilize the mercury, leaving a sponge-like mass of metal. The retort vapors were usually routed through cool pipes to condense the mercury for reuse. Finally, the operator rebuilt the arrastra and repeated the process with another load of ore.³¹⁷

³¹⁶ Meyerreicks, 2001: 143, 195; Young, 1987: 71.

³¹⁷ Ibid.

Section A 2: History of the Timber Industry, 1860-1920

Introduction

The area encompassing the I-70 Mountain Corridor possesses a distinct history wherein mining and railroads drove economy, development, infrastructure, and settlement. The timber industry, in turn, made the railroads and mining possible, providing lumber and logs for construction, ties for railroad tracks, timbers for mine workings, and firewood for heat and steam power. Inclusive in the industry are: logging, in which trees were harvested; milling, where they were dressed into construction products; railroad tie manufacturing; and transportation and storage. This section provides an overview of the industry in the corridor between 1860 and 1920.

Period of Significance, 1860-1920

The timber industry's Period of Significance spans 1860 through 1920. Beginning in 1860, entrepreneurs established the earliest sawmills on Clear Creek to supply lumber to miners. In 1920, the production of lumber, ties, and mine timbers nearly ceased, no longer qualifying as an industry of note. The timber industry was not uniformly present throughout the corridor, instead concentrated in regions with three basic characteristics: substantial forests of trees desirable in both type and maturity; a strong local demand for forest products; and proximity to efficient transportation. Although limited logging occurred in most of the corridor, three particular regions met these criteria: Clear Creek drainage, especially Lawson west to present-day Eisenhower Tunnel; Ten Mile Canyon and Straight Creek in Summit County; and along the Eagle and Colorado rivers in Eagle County. The timber industry shared an intimate and often dependent relationship with mining and railroads. Thus the industry's rise and fall closely paralleled their trends, which differed for each region. As a result, the timber industry in each region thrived during narrower timeframes within the overall Period of Significance. These timeframes are summarized separately below.

Regardless of region, pertinent Areas of Significance include Architecture, Commerce, Community Planning and Development, Conservation, Economics, Engineering, Exploration/Settlement, Industry, Politics/Government, and Transportation. The industry was a primary engine for permanent Euro-American settlement in the corridor. Loggers and tie cutters were among the earliest settlers to pioneer portions of the mountains lacking resources for mining and agriculture. The industry supplied mining, railroads, and settlements with the physical materials for their development. The industry was also a major employer and economic contributor. Level of significance is local, although some resources may be statewide depending on further research.

Overview of Forest Products

In present-day I-70 Mountain Corridor, the timber industry historically generated five general categories of forest products, which influenced logging operations. The products include lumber, railroad ties, mine timbers, raw logs for construction, and firewood.

Lumber was fundamental to industry and settlement, especially construction. Dimension lumber came from sawmills in standard sizes such 1"x8", 2"x4", and so forth, and companies also produced custom pieces for special applications. Prior to the 1930s, most dimension lumber was rough-cut and true in size. During the Great Depression, however, lumber companies slightly reduced finished sizes so they could produce more pieces per tree, and this differentiation between nominal and actual measurement remains in effect. Smooth lumber, produced by planing mills, also was smaller in actual dimension because mills stripped away some bulk during treatment. Although the timber industry measured finished lumber in inches, it applied a different standard to quantify large volumes of wood. Specifically, the industry recognized the board-foot, which was a plank 1' by 1' in area and 1" thick. This unit of measure was important for estimating timber reserves and the output of individual sawmills or the entire industry, collectively.

Lumber production occurred in several basic stages requiring capital, labor, and infrastructure. Given this, most producers were organized companies or partnerships with considerable resources. In overview, the steps were harvesting or felling trees, hauling them to a sawmill, reducing the trees into lumber, and transporting the finished product to a customer or lumberyard. Loggers, commonly known as lumberjacks, were the individuals who felled the trees, usually company employees. The loggers selectively chose trees based on type and size, with the largest naturally the most desirable. In terms of species, yellow pine was prized for its clarity, grain, and uniformity, but because scarce, lumber companies usually settled for lodgepole pine. Engleman spruce was harvested for general construction lumber, while blue spruce was too fibrous and difficult to work.³¹⁸

Loggers usually labored in pairs using massive steel saws. They determined the most appropriate direction in which to fell a tree, cut a shallow notch on that side of the trunk, sawing from the far side toward the notch. Once the trunk's stability had been compromised, the tree pivoted over the notch and crashed to the ground. The team usually made its cut several feet above their footing, which, during winter, was the snowpack surface. If the snowpack was thick when the tree was felled, then the stump could appear quite tall after spring thaw. The team used saws, axes, and froes to trim away bark and branches, known as slash, preparing the log for transport to the sawmill. Teamsters and muleskinners hauled the cut logs to the mill. If the trees were harvested near the mill, then muleskinners used horses, mules, or oxen to drag the logs with chains. Whenever possible, the muleskinners used gravity to advantage, skidding the logs directly downslope along paths cleared of obstacles. Over time, the traffic eroded relatively straight furrows known as skid trails or timber slides, and when these became deep, workers embedded short logs across the path, reducing friction on those being dragged. In heavily forested areas, well-capitalized companies employed portable, steam donkey engines to winch massive logs onto loading frames. Where the distances from the sawmill were greater, the lumber companies gathered cut logs at loading stations, transferring them onto wagons for shipment. Once the raw logs reached the sawmill, they were stacked onto another platform at the mill's head.

³¹⁸ Sudworth, George B. "White River Plateau Timber Land Reserve." *Twentieth Annual Report of the United States Geological Survey to the Secretary of the Interior, 1898-1899*. Washington, D.C.: Government Printing Office, 1900, 134.

Unlike the Pacific Northwest, the Mountain Corridor lacked thick stands of lofty trees. Instead, the forests were inconsistent, thin in many places, and quickly cut. Thus, sawmills had to be small, simple, and portable to follow the axe (see Illustration A 2.1). In overall design, they consisted of small-scale engineered structures enclosed in a shed, providing protection against adverse weather. A saw-frame constituted the mill's main engineered structure, a timber lattice 3' to 6' wide, as high, and 30' to 100' in length, depending on facility size. Near center was another frame with radial ripaws to cut logs lengthwise, a crosscut saw to trim the ends, and their drive mechanisms. The power source was anchored to an adjacent timber foundation, with steam donkey engines universal prior to the 1910s, and gasoline engines popular afterward. The shed enclosure was a building over the saw-frame, sometimes open on the sides, with a room for the engine and saws.

To mill lumber, workers rolled a log off an elevated platform and onto a dolly at the saw-frame's head. Fastening the log to the dolly, they slowly winched the dolly on rails or rollers into the saw-blades. Radial saws cut the logs into desired dimensions, while the crosscut blade chopped the pieces to length. Workers then pushed finished lumber over more rollers to the end of the saw-frame and either loaded it onto a wagon for shipment or stored it on bolsters. In a few cases, well-capitalized companies, such as the Clear Creek Fluming Company near Silver Plume, floated the lumber to a yard in flumes. Sawmills on the scale of those in the Mountain Corridor were run by two to five workers and could process between 2,000 to 4,000 board-feet per day.³¹⁹

Although a sawmill was a lumber operation's most important component, it was by no means the only facility. In most cases, the sawmill was center to a small camp including a blacksmith shop, stables, corral, office, and living quarters. All were proportional to the operation size, large outfits featuring multiple stables for draft animals and several boardinghouses for crew. Where the distance from sawmill to area being cut was too long for a foot commute, loggers worked out of satellite camps. Large crews lived in multiple residence camps, consisting of a boardinghouse, cabins, a stable, and blacksmith shop. Single residence camps housed between two and four workers in one cabin, with stable and, occasionally, a shop. Emphasizing function and economy, the buildings were assembled with material on-hand, logs in the forest and lumber when at the sawmill.

Railroad tie production was much simpler, often requiring no sawmill. Tie cutters, also known as tie hacks, working in independent pairs or for small companies, cut and dressed ties in the field. Railroad companies or brokers were their customers, issuing contracts or paying by the tie. When choosing suitable trees, tie hacks were as selective as loggers but with different criteria. They prioritized the same species, except in sizes ranging from 10" to 15" in diameter, larger trees being too difficult to split and dress into required dimensions. Acceptable ties were 8' to 9' long, flat on two faces, and 9" to 11" thick. The hacks felled trees with saws, lopped off the crowns, segmented the trunks into needed lengths, hewing the required flat faces with an axe. In so doing, the hack produced a finished tie.³²⁰

Although the steps were few and the concept simple, hacks had to possess great skill in order to reduce enough logs per day to make a profit. An efficient hack could produce approximately twenty-two ties in eight hours, and independent workers were paid \$.10 to \$.50 per piece, depending on ease of access. When employed by a company, efficient hacks usually earned either \$3.00 per day or \$30.00 per month with room and board. Both wage structures

³¹⁹ Reich, William L. *Colorado Industries of the Past*. Boulder, CO: Johnson Books, 2008, 163; Sudworth, 1900:139.

³²⁰ Wroten, William H. *The Railroad Tie Industry in the Central Rocky Mountain Region, 1867-1900*. University of Colorado, 1956 [Dissertation], 243; Reich, 2008:175.

were commensurate with other resource extractive industries, including lumbering and mining.³²¹

Once the hack finished several ties, teamsters or muleskinners brought them to collection points. As with logs for lumber, muleskinners skidded the ties to the collection points, where teamsters loaded them onto wagons for shipment to the railroad. Ordinarily, producers preferred to float ties to market via rivers, but the Mountain Corridor's waterways were too unreliable. The muleskinners and teamsters may have been employed by a tie company, railroad, or the hacks themselves. In any case, the ties ultimately ended up in stacks at railroad stations and yards. In Clear Creek County, the Colorado Central Railroad stockpiled ties at Idaho Springs, Empire Junction, and Georgetown, all of which had tie production industries in the surrounding forests. In Summit County, the Denver & Rio Grande and Denver, South Park & Pacific railroads relied on Dillon, Frisco, and Wheeler.³²²

Firewood and mine timbers were two types of forest products outside the domain of logging companies. Mining required a variety of timbers to support weak ground in tunnels, shafts, and stopes. Engineers preferred milled lumber because of its regularity, using it in workings expected to be in service for long periods of time. Although lumber outfits offered milled timbers, some well-capitalized mining companies ran their own sawmills for the purpose. Several of Clear Creek County's earliest sawmills were run by mining companies both for in-house needs and to sell commercially. Small mining companies settled for both raw and hewn logs due to their low cost. Independent contractors or miners themselves produced the logs in a manner similar to tie hacks, with almost any species or size acceptable.

In most of the Mountain Corridor, cordwood was the principal heating fuel for households, businesses, and industry through the 1890s. Industry switched to coal at that time because of greater efficiency, but cordwood provided heat in buildings years afterward. Cordwood production was even less organized and centralized than railroad ties or mine timbers. Every settlement employed at least one woodcutter, large towns had sales yards, while many individuals harvested their own wood. Standards were low and almost any portion of a tree would do, standing or not.

As can be surmised, considerable portions of entire forests flowed out of the mountains and to consumers in the Mountain Corridor. Lumber companies cut the tallest and fattest trees, tie outfits felled the smaller ones, and mine operators and woodcutters gathered the rest, denuding entire mountains. Of this, railroad tie industry historian William Wroten noted: "The homesteaders, miners, ranchers, and lumbermen began to cut timber regardless of size, condition, or location. With the coming of the railroads, the forests along the track for miles were overrun with cutters."³²³

Land Use Policy and the Timber Industry

Like most resource extraction industries, logging in the Mountain Corridor initially took advantage of an unregulated environment, which the federal government increasingly controlled over time. Unregulated, the timber industry often overcut its way into demise, leveling entire forests. The government sought balance between forests and industry and consumer needs, and although control restrained the industry, it ensured sustainability.

³²¹ Wroten, 1956:251, 253.

³²² Wroten, 1956:84, 244, 255.

³²³ Wroten, 1956:160.

During the first twenty years of Euro-American presence in the Mountain Corridor, forests were a free-for-all regarding harvest. Weak federal oversight, confusing legislation, and popular sentiment were contributing factors. During the 1850s and 1860s, the federal government recognized settlers' need to harvest trees for individual consumption but made no provision for a timber industry. In 1855, the General Land Office managed the nation's timber on public lands and made some provision to sell forest land for \$1.25 per acre, but for individual use and not commercial harvest. The timber industry was caught in a difficult position because commercial cutting was outlawed, and yet the General Land Office was unprepared to recognize the nation's growing demand for lumber and commercial operations producing it.³²⁴

In Colorado and elsewhere in the West, logging interests circumvented the inadequate legislation in two ways. One relied on the frontier environment, assumption that natural resources were free for the taking, and remoteness from concerned federal agencies. During the 1860s and 1870s, logging companies cut wherever they wanted, with General Land Office staff tacitly accepting the practice because frontier development depended on commercial lumber operations. When caught, which was exceptionally rare, lumber outfits maneuvered to avoid fines and taxation and easily found sympathy in nearby communities. Western settlers considered timber to be either their rightful resource or for those lumber companies furnishing their needs.³²⁵

The other way in which logging interests circumvented outdated legislation was through deceit and loopholes in relevant acts. In 1862, the federal government passed the Transcontinental Railroad Act, granting railroads rights to harvest trees in broad corridors along rights-of-way. Although the Act intended the trees be for in-house use only, timber interests cut them for commercial markets. The Homestead Act of 1862 was a vehicle by which logging interests themselves amassed forest land. The Act allowed individuals to patent up to 160 acres and cut the trees as needed for settlement purposes. The timber companies abused this by hiring individuals to file homesteads and sell the land to the company principals, who consolidated the holdings into considerable tracts. During the 1880s alone, as many as half of the homesteads filed in the West were under such pretenses.³²⁶

During the 1870s, the federal government passed two more acts complicating timber rights in Colorado. The General Mining Act of 1872 gave claim owners the right to harvest timber on their land in support of mineral development and associated residence. As with the Homestead Act, logging companies paid individuals to stake claims and transfer title. Companies selling wood products within mining district argued that the timber was ultimately for mining, just not for their own consumption. In 1878, the federal government tepidly tried to address the lack of legislation specific to timber with the Stone and Timber Act. The policy allowed individuals to buy as much as 160 acres of forest land that was unfit for agriculture at \$2.50 per acre for the timber. The restriction, however, was that the land had to be for personal use and not for sale to lumber companies. The industry, however, had an easy time amassing large holdings for commercial harvest.³²⁷

During the early 1890s, legislators finally conceded that logging was taking a toll on western forests, and the time for definitive, enforceable regulation was at hand (see Illustration A 2.2). In 1892, Congress amended the Stone and Timber Act, permitting individuals to buy land

³²⁴ Steen, Harold K. *The U.S. Forest Service: A History*. Seattle, WA: University of Washington Press, 1976, 7, 9.

³²⁵ Ellis, Erl H. and Ellis, Carrie Scott. *The Saga of Upper Clear Creek: A Detailed History of an Old Mining Area, Its Past and Present*. Frederick, CO: Jende-Hagan Book Corporation, 1983, 149; Steen, 1991:9, 159, 195.

³²⁶ Renze, Dolores C. *A Brief Study of the Lumber Industry in Colorado*. Denver, CO: University of Colorado at Denver, 1949 [term paper], 22; Steen, 1991:2-3, 24.

³²⁷ Steen, 1976:8, 295; Wroten, 1956:192.

and convey it *en masse* to lumber companies. More germane was the Forest Reserve Act, which President Cleveland signed into law in 1891. The Act authorized the president to establish Forest Reserves, manage the timber as a resource, protect the forests from destruction, and maintain watersheds. To generate income from inevitable logging, stands of trees and tracts of land could be sold, but only at appraised market value. Trees designated for harvest had to be marked, cut under Department of the Interior supervision, and consumed in the same state or territory. The rights granted by the 1872 Mining Law were unaffected, and if a claim was staked in a timber reserve (later a National Forest), the owner still had rights to harvest for operational use. Thus in Clear Creek and Summit counties, logging continued during the 1890s as before.³²⁸

As soon as the Act passed in 1891, Cleveland designated the White River and Pikes Peak reserves, among the earliest. Western representatives and mining and timber industries howled in protest. Several modifications mollified their ill feelings and provided clarification for better regulation by the General Land Office. First, legislators passed a bill in 1893 that clearly defined the purpose of the reserves as for protection of water sources and sustained timber harvest. Second, the Act stated that local inhabitants could still cut trees for their own uses at no cost, but under a permit system. They could also obtain rights-of-way through reserves to in-holdings.³²⁹

During its first ten years, the law was in name only due to a lack of support, insufficient staff, and public sentiment in favor of logging. Illicit logging continued in the corridor, as elsewhere. In terms of local protection for the timber industry in Colorado, a surveyor with the U.S. Geological Survey noted in 1900:

Strangely enough, nearly all illicit lumbering and other timber predations are looked upon by settlers as blameless ventures. Such operations furnish a limited amount of employment to the poorer classes, and but for occasional sore enmities toward the richer mill operators, the latter are held in the light of benefactors. Indeed, by very many they are considered to be taking only what rightfully belongs alike to them and all other settlers.³³⁰

Most logging companies continued harvesting as before, except now carefully avoiding detection. The companies cut trees quickly, shipped the lumber as fast as it was milled, kept no stockpiles, and relocated frequently. They were also wary, maintaining word-of-mouth communication only. Such operations became notorious for rampant destruction, second only to woodcutters and mining interests.³³¹

In 1905, President Theodore Roosevelt and forester Gifford Pinchot began a sweeping plan to tighten federal policy regarding logging, regulation, and enforcement of the Timber Reserve Act. Both advocated timber harvest, but on a sustainable level. Creating the United States Forest Service, they placed the agency under the Department of Agriculture, included more provisions for commercial logging, and increased field staff for better enforcement. As part of this, the Forest Service divided the Pikes Peak Timber Reserve into regions, including a Clear Creek Ranger District overseeing logging in Clear Creek County. Although woodcutters and mining interests were still free to clear-cut their claims, the lumber companies had to abide by the Forest Service regulations. In Summit and Eagle counties, within the White River Timber Reserve, oversight was not as strict.

Roosevelt and Pinchot culminated their program under great opposition in 1907 with designation of what were known as the midnight forests. Conservative legislators, who hated the

³²⁸ Defebaugh, James Elliott. *History of the Lumber Industry of America*. Chicago, IL: The American Lumberman, 1906, 383, 417; Runte, Alfred. *Public Lands Heritage: The National Forest Idea*. Niwot, CO: Roberts Rinehart Publishers, 1991, 45; Steen, 1976:36; Steen, 1991:30.

³²⁹ Steen, 1991:29.

³³⁰ Sudworth, 1900:143.

³³¹ Sudworth, 1900:167; Wroten, 1956:67.

idea of control over public lands, passed a bill rescinding the president's authority to designate timber reserves. Knowing that Roosevelt would not sign the bill by itself, they attached it as a rider to a key appropriations package he was unable to veto. During the ten-day grace period Roosevelt had before signing, he and Pinchot worked furiously identifying forests in need of designation and adding them to the program as national forests. After they finished setting aside millions of acres, Roosevelt signed the package on the last day of the grace period ending the president's ability to designate additional tracts. Through this game of political chess, Roosevelt and Pinchot established today's forest system and its improved regulation of logging. The overall structure of the Forest Service and the national forests changed relatively little afterward. In the corridor, the only major alterations were division of the Pikes Peak, Leadville, and Medicine Bow national forests into the Arapahoe National Forest in 1908, with further division into the Roosevelt National Forest in 1910. In so doing, the Forest Service increased oversight and control of timber resources on the Front Range.³³²

The Timber Industry in Clear Creek Drainage

The timber industry was significant in Clear Creek drainage between 1860 and 1920. The industry began by producing logs, lumber, and cordwood for placer miners and their communities during the early 1860s gold rush. The initial boom collapsed around 1864 and the county fell into a depression, temporarily stalling the nascent industry. In 1866, the boom shifted to the western drainage and its silver mines, drawing the timber industry into steady growth in parallel with and as a result of mining. See Illustrations A 2 – A.4 for general geography.

When the Colorado Central Railroad graded up Clear Creek to Georgetown in 1877, it fostered a mining boom, increasing demand for lumber and mine timbers. The railroad lowered shipping costs within the county, linked sawmills with local consumers, and provided an outlet to markets, mostly in Denver. The railroad also created a demand for ties, supporting a new segment of the drainage's timber industry. Completion of the Georgetown, Breckenridge & Leadville Railroad to Graymont, several miles west of Silver Plume, improved access to the county's western forests in 1884. As a result of these factors, the timber industry reached peak production during the 1880s and then waned shortly after 1900, slightly ahead of statewide trends. Although the industry left few if any production records for the drainage, decreased coverage in archival sources reflect the decline. Several broad factors were to blame, including logging regulation, dwindling forest reserves, slowing of mining, and competition from other regions. Viability of the timber industry ended in 1920 with the collapse of mining and exhaustion of the forests. In terms of historic resources, lumber and tie production left a tangible legacy in the form of logging camps, sawmill sites, and remnants of infrastructure. In contrast, collection of cordwood and raw logs for both construction and crude mine timbers left little distinct evidence. Because of this, lumber and tie production is emphasized below.

The Timber Industry in Clear Creek Drainage, 1860-1876

Mining and the timber industry in Clear Creek drainage were integrally tied, as sustained logging followed the discovery of gold by only one year. George Jackson found gold at the mouth of Chicago Creek in 1859, stimulating a rush to what became Idaho Springs. Prospectors staked an almost unbroken series of placer claims along Clear Creek, their camps growing at each center of mining. Idaho Springs thrived at Jackson's discovery point, Spanish Bar near the

³³² Ellis and Ellis, 1983:246; Runte, 1991:55; Wroten, 1956:208.

confluence of Clear Creek and Fall River, Mill City (later Dumont) several miles west, Valley City (later Empire) on the West Fork, and Georgetown on the Main Fork. Most mining was for placer gold, although a handful of experienced prospectors began developing hardrock veins.

As the boom spread, miners and community organizers began felling trees for building materials and gathering downed wood for heating fuel. As was common on the frontier, miners used the logs in their raw state, sufficient for small buildings, retaining structures for placer tailings, and aspects of infrastructure. Lumber, however, was dearly needed for the refined structures of advanced placer work such as flumes, sluices, and pit linings. Community organizers also wanted lumber for buildings in settlements.

Envisioning greater profit from lumber than gold, several entrepreneurs constructed primitive sawmills in 1860. George L. Nuckolls built a mill at Empire, someone else installed a facility at Idaho Springs, and their lumber was consumed as fast as it was milled. Other entrepreneurs quickly arranged to freight necessary equipment across the plains from the east, no small undertaking, to erect a few more sawmills during 1861. Nuckolls put up a sawmill at Georgetown, converting his Empire sawmill into a stamp mill for gold ore. Paul Lindstrom replaced Nuckolls at Empire, and Reynolds, Hopkins & Company built a sawmill on Clear Creek several miles above Spanish Bar. Other producers not specifically mentioned in archival sources operated in the county during the early 1860s as well. All the early sawmills were small, simple, and powered by either water or steam. Their rates of production were limited, but they provided the lumber needed for growth. In Clear Creek valley, forests of lodgepole pines and spruce surrounded the towns where the mills were located, and operators had a ready supply on hand.³³³

Just as the industry was starting, it underwent the first of several adjustments in response to the boom-and-bust cycles of mining. During the county's first years, most miners focused on placer gold and few attempted to win the metal from its hardrock source. They exhausted the placers within four years and the boom collapsed. The drainage fell into a depression, the demand for lumber decreasing significantly. Just enough residents and nascent hardrock mines remained to support a few sawmills, but many operators either shut down or relocated.

In 1864, prospectors discovered rich silver ore high in the mountains southwest of Georgetown, drawing interest to the drainage's western portion. A rush to the Argentine Mining District commenced the following year, and prospectors began searching for more silver around Georgetown. They found what they sought on both sides of Clear Creek valley, the rush expanding to Georgetown and creating the small camp of Silver Plume. Limited ore production began in 1866, with investors erecting several smelters. The activity evolved into a lasting mining industry, requiring lumber, mine timbers, and mountains of cordwood. In response, the timber industry shifted from the drainage's eastern portion. Empire was included in the western boom both because of proximity to Georgetown and some of its mines offered silver.

The Bay State Gold Mining Company operated a sawmill at Empire to supply its needs, but most new mills went up in the mature forests around Georgetown and Silver Plume. At least one sawmill produced lumber on South Clear Creek, south of Georgetown. McNulty & Hawthorne ran the St. Clair plant in the vicinity, one of Georgetown's most prolific lumber producers through the 1870s. Most other sawmills were on the Main Fork of Clear Creek west of Silver Plume. The Baker Silver Mining Company established Bakerville at the Main Fork and Grizzly Gulch confluence in 1867 as a camp for its smelter, the settlement evolving into one of the county's principal lumber centers instead. As the company erected its smelter, both Edward

³³³ Harrison, Louise C. *Empire and the Berthoud Pass*. Denver, CO: Big Mountain Press, 1964, 38, 39, 42; *Rocky Mountain News* (1/22/61); *Rocky Mountain News* (4/4/61): 2.

O. Kennedy and Joseph Watson built substantial sawmills, with R.B. McKay following several years later (see Illustrations A 2.4).³³⁴

During the 1870s, the eastern drainage remained relatively quiet, although several sawmills supplied limited demand. At least one commercial facility operated in Idaho Springs, John Dumont's Hukill Mine at Spanish Bar featured a small mill, and another commercial plant went into business near Lawson with the rush to Red Elephant Mountain in 1876. The western drainage remained the center of logging through the decade as mining increased in intensity and sophistication. Sawmills began working at the mouths of many Main Fork tributaries, all with handsome stands of trees. In addition to three sawmills at Bakerville, companies produced lumber in Grizzly and Herman gulches and at Fisk's Station near present-day Loveland ski area. J.S. Kearney ran a large operation west of Bakerville at the mouth of a gulch named for him.³³⁵

The Timber Industry in Clear Creek Drainage, 1877-1920

In 1877, after ten years of consistent growth in the drainage's western portion, the timber industry underwent major transition. The Colorado Central Railroad laid rails from its Floyd Hill terminus to Georgetown, bringing the industry into peak production and restoring activity in the drainage's eastern half. As early as the mid-1860s, William A.H. Loveland and other early Colorado capitalists promoted the idea of building a railroad deep into Clear Creek and Gilpin counties and connecting the system with the Union Pacific at Cheyenne. They organized the Colorado Central Railroad, completed a line to Black Hawk in 1872, and pushed for Idaho Springs, stalling at the base of Floyd Hill in 1873 due to financial woes. Loveland and others had the money to finish the project in 1877, thus track gangs graded the long-desired route through Idaho Springs and up Clear Creek valley to Georgetown, the designated terminus. The Colorado Central passed through nearly all the drainage's principal towns except Empire, whose Empire Junction station was several miles away.

The railroad introduced a new set of variables that dramatically changed conditions for the timber industry. One of the principal impacts was indirectly transmitted through the mining industry. In particular, the railroad reduced transportation costs and improved service within and to the drainage, stimulating a major mining boom. Because lumber and mining were wed, the demand for lumber soared. The railroad further eased the logistics and costs of moving lumber from sawmill to consumer. Lumber companies in the western drainage were in turn able to distribute product to buyers in the eastern portion at low rates. Similarly, the railroad provided a link between lumber companies and outside markets, primarily in Denver. At first, little lumber passed beyond the drainage because most went to local mines and settlements. But by the early 1880s, the industry was productive enough to ship to Denver.

An entirely new wing of the timber industry was a direct result of the railroad. The Colorado Central employed a small army of tie hacks to provide the thousands of necessary rail ties when it began grading. Previously, the industry gave little thought to ties without a railroad to consume them. When the Colorado Central resumed construction of the Clear Creek line in 1877, tie production spiked before gradually falling off. For several years after the Colorado Central completed its main line, the railroad continued buying ties on a reduced level for switches, sidings, and stockpiles at principal stations. Tie production was unkind to forests. Tie hacks harvested many of the trees other lumber operations left in place as too small, also working in areas too remote for gatherers of cordwood and mine timbers.

³³⁴ Hollister, Ovando J. *The Mines of Colorado*. Springfield, MA: Samuel Bowles & Co., 1867. [Reprinted by Promontory Press, New York, NY, 1974], 246; *Daily Colorado Miner* (5/27/73): 3; Ellis and Ellis, 1983:208.

³³⁵ Ellis and Ellis, 1983:149.

In 1881, four years after the drainage received its first railroad, the Union Pacific announced plans to build a second line ascending west from the Colorado Central terminus at Georgetown. The Union Pacific hoped to grade the Georgetown, Breckenridge & Leadville Railroad (GB&L) over Loveland Pass through Summit County and to Leadville, but struggled for three years finishing the track to Silver Plume. After track gangs already laid rails up the Middle Fork of Clear Creek toward Bakerville, the Union Pacific cancelled further work in 1884. Instead of ending the line at the logging town of Bakerville, the railroad attempted to secure the lumber trade for itself by building Graymont as its terminus instead. Partially successful, the railroad effectively penetrated the drainage's principal logging area.

From the moment workers first broke ground, the GB&L exacerbated trends already set in motion by the Colorado Central. The GB&L provided direct rail service to the drainage's principal lumber companies, lowered distribution costs within the drainage, and improved access to the Denver market. In addition, GB&L revived tie demand, and although demand fell somewhat when the track was finished, the Union Pacific used both GB&L and Colorado Central as a single tie collection system to supply maintenance programs on its plains routes. The impact on the timber industry was predictable. Where the forests still offered enough trees, tie hacks went to work and entrepreneurs built additional sawmills to feed high demand for lumber. A few new mills were installed on Chicago Creek south of Idaho Springs and on the South Fork of Clear Creek, but most went up on the Main Fork west of Silver Plume.

Even before the GB&L announced its plans, lumber interests were already moving west up the Main Fork. During the late 1870s, brothers J.S. and Frank Kearney opened one of the most important sawmills at Fisk's Junction, renamed High Line around 1880 after the brothers' plant. Because the facility was western-most, wagons carried finished lumber great distance to Silver Plume. Other logging companies in the area faced the same problem. When the GB&L began grading, it offered the promise of lower transportation costs, but the brothers were unwilling to wait. Instead, they began constructing their own shortcut to Silver Plume. In 1881, they interested William Loveland in the Clear Creek Fluming Company and built a flume on the south side of Clear Creek from High Line to a yard several miles west of Silver Plume (see Illustration A 2.5). The flume replaced wagons and carried both finished lumber and raw logs for the Kearneys and other companies. The High Line mill and flume were central to the Kearneys' small lumber empire, expanded further in 1883. They extended the flume to Silver Plume, added another sawmill at Graymont, and opened a lumber yard in Denver and began shipping by rail once the GB&L was finished.³³⁶

The Kearneys were by no means the only large lumber producers on the Main Fork during the 1880s, as new ventures joined the others predating the GB&L. Henderson & Company established a mill at Graymont, Anderson & Porter was in business by 1886, with the Walter Brothers following next year. It remains unknown if these plants started because of the nearby GB&L railhead or moved from other locations that had been cut over.³³⁷

Two developments caused logging to slow during the late 1880s: expansion of stumpage areas and regulatory enforcement. Most accessible stands of trees had been cut over after ten years of logging, forcing lumber companies to settle for smaller trees farther from their mills. Although the western drainage still offered enough trees to sustain the industry, its productivity and, hence, profitability, began irreversible decline. Forest devastation also set in motion increased regulatory enforcement. Although federal and state laws were nebulous about commercial logging, the General Land Office knew that industry was necessary and often

³³⁶ Ellis and Ellis, 1983:150, 153.

³³⁷ Ellis and Ellis, 1983:150, 153.

overlooked Clear Creek operations as long as the lumber was consumed locally. Lumber companies in the western drainage transgressed that tolerance by shipping product to Denver, provoking legal action in 1887. Community activists complained about exportation and convinced a legal authority, unspecified in archival sources but probably the General Land Office, to enforce regulations. The authority started with Henderson & Company, the largest exporter, requesting the firm cease shipment. When the company balked and continued anyway, the authority made an example of owner J.S. Henderson by having him arrested. This eliminated large-scale lumber exports, forcing the industry back to local demand. But because consumption was finite, lumber production slowed.

The industry adjusted as some mills closed and others changed ownership. The Kearney brothers continued their Graymont facility, selling their High Line mill to Frank L. Johnson, who closed it in 1887. Henderson sold his Graymont mill and bought one of the other plants at High Line under the firm of Jennings & Henderson. Charles R. Waters purchased the third High Line mill. Henry L., Lewis L., and Phillip L. Roberts and J.S. Graham formed Roberts Brothers & Graham to fill the void that Henderson left at Graymont. Although archival sources make little mention of logging elsewhere in the drainage, other areas such as Chicago Creek and the South Fork of Clear Creek experienced a similar pattern.³³⁸

At the end of 1893, the Silver Crash halted mining across the West, contributing to a nationwide depression, and forcing marginally profitable lumber companies out of business. The drainage's timber industry contracted again as a result, but those outfits surviving the depression returned to prosperity within a short time. Mining recovered later in the decade and with it, a demand for lumber and mine timbers. Meanwhile, existing producers faced less competition because the depression reduced their numbers, product prices remaining steady. During this time, sawmills continued operating along all three forks of Clear Creek, as well as Chicago Creek.

The resurgence was not long-lived, as retreating forests forced the timber industry to shrink again after 1905. To manage remaining resources, the Department of the Interior began enforcing procedures stipulated by Forest Reserve Act of 1891. The act required logging outfits to apply for a permit, mark targeted trees for forester approval, and harvest them under supervision. Although necessary to protect remaining stands, the process reduced the number of available trees and added administrative overhead. The Roberts brothers, who opened a new sawmill on the Main Fork in 1904, ignored the regulations and suffered severe consequences. Their mill was shut down in 1906 and permanently closed in 1908. Overall, increased regulation impacted the timber industry.³³⁹

Mining influenced the timber industry, as well. The eastern drainage still yielded plenty of gold, but silver mines in the west fell idle because ore reserves were exhausted after nearly fifty years of production. The railroads, settlements, and regional economy hinged on mining, and when mining declined, so did demand for lumber and mine timbers. The demand for railroad ties, however, remained strong during 1906 and 1907. Edward J. Wilcox and other investors interested in the Argentine Mining District southwest of Georgetown organized the Argentine Central Railroad in 1906 to grade a line from Silver Plume. Wilcox finished the main line to his Waldorf Tunnel during the year and completed spurs to other mines in 1907, stimulating a small wave of construction in the district. But the Argentine demand was not enough to offset the greater slump around Georgetown and Silver Plume.

During the first half of the 1910s, conditions worsened for the timber industry. Silver production still ebbed, the Argentine district went quiet, and gold mining in the eastern county

³³⁸ Ellis and Ellis, 1983:150, 154.

³³⁹ Ellis and Ellis, 1983:150, 154.

tapered. The Forest Service enforced regulations and loggers had to pull trees from farther distances. Between these compounded factors, and little mention of lumber in archival sources, relatively few sawmills operated by this time. Those remaining supported the mining industry, the drainage's economic foundation. Mining enjoyed a notable revival due to World War I, demand for lumber and mine timbers rising in tandem. Although tie production, already low, fell farther, the timber industry stabilized for a while. But when Armistice brought an end to World War I in 1918, the national economy began slipping into a depression. Poor economic conditions caught up with Clear Creek drainage in 1919, as exhausted ore reserves left the mining industry precarious. Gold production collapsed first, most operations in the east closing permanently in 1919, with silver and industrial metals following in 1920. With little mining, minimal construction, and no tie consumption, the market for forest products in the drainage evaporated. At the same time, suitable trees became scarcer than ever. The net result was dissolution of the timber industry in 1920. Several small sawmills operated afterward, but even these struggled due to low demand, high operating costs, and widespread availability of salvaged lumber.

The Timber Industry in Dillon and Frisco Area

In Summit County, the timber industry paralleled its Clear Creek neighbor in overall trends and patterns, the principal difference being a compressed timeframe. The area of study includes Straight Creek from present-day Eisenhower Tunnel to Dillon, the Blue River valley around Dillon and Frisco, Ten Mile Canyon, and the area around Copper Mountain. See Illustrations A 1.3.1 and A 1.3.2 for general geography.

The industry was vital between 1879 and 1912, and particularly during three intervals. In 1879, the industry began producing lumber for mining and construction at Dillon, Frisco, and Wheeler. Completion of two railroads into the region between 1881 and 1883 brought the industry into a boom by opening external markets and consuming thousands of ties. In 1886 mining slowed and the industry contracted, becoming largely idle for four years. The second discrete period began in 1890 when a mining revival restored a strong demand for lumber, and the railroads began replacing decayed ties. In response, the timber industry produced ties for the railroads, timbers and lumber for mining, and more lumber for the principal towns. The timber industry sent products to other markets, as well, the most important being Leadville and the Robinson Mining District. The Silver Crash and subsequent depression stifled the industry from 1894 through 1897. The 1898 mining revival fostered a strong demand for lumber and mine timbers again in Leadville and the Robinson district, followed by Ten Mile Canyon and Dillon. Mining reached a peak period of production, the railroads ordered new ties for maintenance of their tracks, lumber companies enjoying sound business as a result. The third period ended in 1912. Timber resources became difficult to obtain as forests showed signs of exhaustion, and the United States Forest Service enforced harvesting regulations. Demand for lumber and mine timbers fell with decline of mining in Ten Mile Canyon and the Robinson district. Production of railroad ties nearly ceased. The timber industry never recovered in the area.

As with Clear Creek County's timber industry, archival sources offer few comprehensive records regarding Summit County. Its history is pieced together from a few sources and interpreted from trends in mining and related fields. In terms of historic resources, lumber and tie production left the most tangible legacy in the form of logging camps, sawmill sites, and remnants of infrastructure. In contrast, the collection of cordwood and raw logs for both construction and crude mine timbers left indistinct evidence. Because of this, lumber and tie production are emphasized below.

The Timber Industry in Dillon and Frisco Area, 1879-1886

Logging began in Summit County during the gold rush of 1860 as placer miners cut trees for cabins and mining structures. Most if not all logging was local to Breckenridge, where entrepreneurs built several sawmills to produce finished lumber. Because Ten Mile Canyon and what became Dillon lacked noteworthy gold deposits, the area saw nothing more than occasional prospecting for nearly twenty years.

During the late 1870s, Henry A. Recen and brothers established a prospecting camp at the present site of Frisco, locating several silver veins that would have sparked a rush if not within the shadow of richer mining districts. Leadville in particular drew prospectors and investors away from Summit County, becoming one of Colorado's most important mining centers. In 1879, the Recens found more silver veins, finally piquing other individuals. A few local investors provided capital for claim development, as community organizers platted Frisco and Dillon. Both towns were crossroads connecting Clear Creek County to the west, Breckenridge and South Park to the south, and Kremmling to the north. These routes funneled heavy traffic onto the Leadville and Robinson district road, ascending Ten Mile Canyon.³⁴⁰

Development of prospects and Dillon and Frisco created a need for lumber and mine timbers. Although sawmills existed at Breckenridge ten miles south, producers either sold locally or shipped to Leadville at premium prices. In 1879, Charles F. Shedd, Frisco founder and mercantile operator, established the first sawmill to profit from local demand. Within a short time, other entrepreneurs built additional sawmills farther south up Ten Mile Canyon, not only supplying the Frisco area, but also the new Robinson Mining District at the base of Fremont Pass. The hamlet of Wheeler, near today's Copper Mountain, attracted several ventures because it was almost equidistant between the two markets. Wheeler became large enough by 1880 to receive a post office due in large part to nascent lumber operations.³⁴¹

Logging matured into a timber industry during the early 1880s due to several factors. First, prospecting intensified around Frisco, a number of companies bringing their Ten Mile Canyon mines into production. Second, Frisco and Dillon grew significantly in response. Third, the towns hosted two railroads. The Denver & Rio Grande Railroad (D&RG) graded its Blue River Branch from Leadville to Wheeler in 1881 and finished the track to Dillon the following year. In direct competition, the Denver, South Park & Pacific Railroad (DSP&P) pushed its High Line from South Park over Boreas Pass to Dillon in 1882, continuing to Leadville in 1883. Although the two railroads approached Summit County from opposite directions, both sought its mining trade. By extension, they were also interested in forest products, which could be shipped to Leadville or Denver. In regards to this point, the first spur line that the DSP&P graded after it reached Dillon was east and up the Snake River to the sawmills at Keystone.

The two railroads had significant impacts on the timber industry, rendering markets such as Leadville accessible. In response, entrepreneurs established sawmills in Ten Mile Canyon and around Dillon in 1884 and 1885. J.S. Scott, another Frisco founder, organized Scott & Officer and built a sawmill at the mouth of present-day Officer Gulch. C.F. Williams ran another near Frisco, and several more worked at Wheeler. Dillon had the Malaby, Israel May, and O.W. Decker mills on Straight Creek. The railroads also fostered heavy tie production when

³⁴⁰ *Colorado Mining Director, 1883*. Denver, CO: The Colorado Mining Directory Co., 1883, 847; Gilliland, Mary Ellen. *Frisco! A Colorful Colorado Community*. Silverthorne, CO: Alpenrose Press, 1984, 6.

³⁴¹ Bauer, William H., Ozment, James L., Willard, John H. *Colorado Post Offices: 1859-1989*. Golden, CO: The Colorado Railroad Museum, 1990, 151; "Breckenridge's Boom" *Colorado Miner* (3/20/80): 3; *Colorado Miner* (5/8/80): 3; Gilliland, 1984:10.

constructing their tracks through Summit County. The demand slowed after construction but remained firm for several years as contractors furnished tie stockpiles at stations and sidings.³⁴²

Just as the timber industry showed signs of a boom, two trends softened demand for forest products during the mid-1880s, forcing the industry to contract. First, the value of silver, on the decline during the first half of the 1880s, impacted mining by 1886. The major external market for lumber dried up as mining companies in Leadville cancelled development projects, and the Robinson district went quiet. Local demand also collapsed when mines in Ten Mile Canyon closed, and the DSP&P and D&RG stopped contracting for ties. By 1886, Frisco and Dillon had one lumber firm each while none existed in Wheeler.

The Timber Industry in Dillon and Frisco Area, 1890-1893

Beginning in 1890, the timber industry in Ten Mile Canyon and the Dillon area briefly returned to prosperity. The federal government passed the Sherman Silver Purchase Act, and a climate conducive to mining returned to the central mountains. Demand for lumber resumed as well, with the timber industry shipping to Leadville and the Robinson district. The mines in Ten Mile Canyon and around Dillon were slower to respond, however, prompting Frisco business interests to offer incentives to mining companies. The town would provide millsites, waterpower, and lumber at no charge to those companies willing to engage in serious development. Nearly all principal mines reopened by 1892, stimulating a parallel wave of construction.³⁴³

The timber industry responded with new sawmills. John Safford, Shad Smith, and others ran mills in Ten Mile Canyon, while Wheeler featured the Cogswell and Geberson plants. Win Shaw and a Mr. Morgan sawed lumber on Miner's Creek, while Israel White continued his operation on Meadow Creek, both near Frisco. J.B. Cunningham maintained a sawmill in town. Dillon had at least three sawmills including Caldwell & Black, Williams & Wood, and Israel White's second facility. Railroad ties also came back into demand. In general, untreated pine ties had a lifespan of ten to fifteen years on mountain railroads, with the DSP&P and D&RG in Summit County nearing this threshold. Thus, the two railroads began replacing ties on their tracks within the county, and elsewhere. Tie hacks returned to the forests in force, several contractors establishing offices in Dillon and Frisco.³⁴⁴

The federal government repealed the Sherman Silver Purchase Act at the end of 1893, precipitating the Silver Crash. The value of silver fell to its lowest point in decades, devastating mining and dependent industries, including logging. The revival enjoyed by the timber industry during the early 1890s came to an abrupt halt.

The Timber Industry in Dillon and Frisco Area, 1898-1912

When the Silver Crash struck with full force in 1894, the central mountains descended into a deep depression. Most mines in the region from Leadville north to Frisco historically produced silver and industrial metals, now at half their previous values. Nearly all prospecting ceased, mines shuttered, construction stopped, and the DSP&P and D&RG railroads reduced schedules. Local demand for lumber evaporated, and because the railroads cut back on maintenance to save costs, they ordered no more ties. Most lumber outfits active during the early 1890s suspended work, leaving only several sawmills. Israel White still operated in Frisco and

³⁴² *Colorado Business Directory*. Denver, CO: James R. Ives & Co., 1884:189; *Colorado Business Directory*, 1885:215, 239; Gilliland, 1999:94.

³⁴³ "General Mining News" *Mining Industry & Tradesman* (7/16/91): 35.

³⁴⁴ *Colorado Business Directory*, 1891:331.

Dillon, and Caldwell & Black and Williams & Wood ran two more mills in Dillon. Wheeler was apparently abandoned. Given the lack of local demand, it seems likely that these outfits shipped outside of the county to Denver or Pueblo. Although the sawmills remained important to their host communities, the timber industry overall was no longer a viable economic force.³⁴⁵

This changed during the late 1890s, when the mining industry revived throughout the region. The economy improved, investors were again willing to risk capital, and most substantial mining companies resumed ore production. Leadville and the Robinson district responded immediately, with Summit County lagging by several years. By 1900, mining companies in Ten Mile Canyon and the Dillon area fully participated, ultimately bringing the area into a key period of production. The mining boom restored demand for lumber and mine timbers, and the railroads began replacing ties again. Lumber producers surviving the depression enjoyed less competition, shipping to Leadville while also fulfilling a growing local need. Demand became strong enough to support several new logging ventures. A.L. Wilson established a lumberyard in Dillon, while C.A. Wilder opened the first sawmill to operate at Wheeler in years.³⁴⁶

By mid-decade, however, the mining revival began waning in Ten Mile Canyon, while Leadville and the Robinson district followed similar trends. For the timber industry, this translated into a reduced demand. At the same time, forests showed signs of exhaustion. The easily harvested trees near old milling centers were gone, and lumber companies had to work on higher mountainsides and deeper in surrounding valleys. Greater transportation distances increased operating costs and discouraged production. In addition, the Department of the Interior began enforcing regulations stipulated by Forest Reserve Act of 1891. The net result was a sharp contraction of the timber industry and gradual decline afterward. Wheeler was totally abandoned when its sawmills and handful of marginal mines closed, while Frisco also lost most of its sawmills. The partnerships of Arduser & McCleod and McCleod & Company bought the only two sawmills left at Dillon.³⁴⁷

The timber industry stabilized at a low level before shrinking yet again during the early 1910s. This time, negotiations between the two railroads were to blame. In 1898, the Colorado & Southern (C&S) bought the DSP&P system, competing against the D&RG for mountain traffic. When the mining revival declined throughout Colorado between 1905 and 1910, the two railroads lost business and entered into cooperative agreements. One of these agreements, formalized in 1911, involved the D&RG line from Leadville to Dillon. The D&RG offered to relinquish Summit County to C&S in exchange for all traffic in Gunnison County. The railroads agreed and D&RG abandoned its Dillon line, leaving C&S as the sole operator through Summit County. The timber industry was a casualty, losing one of its two consumers of railroad ties. The C&S was unable to offset the slack in demand as it cut back on tie replacement due to severe financial difficulties. Between restricted tie consumption and previous closure of most sawmills, the timber industry lost viability in 1912 and never recovered.

The Timber Industry in Eagle River Valley, 1886-1920

The timeframe spanning 1886 to 1920 is the only significant period for the timber industry in the Eagle and Colorado river valleys. When the D&RG graded a track from Leadville to Glenwood Springs in 1886, its contractors harvested thousands of rail ties along the river valley. This large-scale tie operation constituted the region's first timber industry, although no

³⁴⁵ *Colorado Business Directory*, 1895:331.

³⁴⁶ *Colorado Business Directory*, 1901:486, 762.

³⁴⁷ *Colorado Business Directory*, 1906:579.

sawmills were involved. Within a short time, however, D&RG and dependent towns of Minturn, Dotsero, and Eagle demanded enough lumber to support several sawmills. During the latter half of the 1880s, entrepreneurs built additional mills to supply enormous demand for lumber and mine timbers at Leadville, Red Cliff, and Aspen. From this point until 1920, the industry supplied both D&RG tie demand and the distant lumber markets. The timber industry declined sharply and lost importance by 1920 when mining collapsed, the nation entered an economic depression, and D&RG secured replacement ties from other sources. Last, the easily logged forests neared exhaustion and possessed few suitable trees.

Because Eagle County was remote, difficult to access, and had little internal demand for lumber, logging of substance did not begin until D&RG established a presence on the Eagle and Colorado rivers. The D&RG did so when it entered a heated race against the Colorado Midland Railroad to reach Aspen from Leadville. The Colorado Midland chose a route west and directly over the Sawatch Range, while D&RG planned to descend the Eagle River to the Colorado River, continuing to Glenwood Springs, and ascending the Roaring Fork to Aspen. The D&RG graded along the rivers in 1886, finishing the track to Glenwood Springs the next year. The railroad established the town of Minturn on the Eagle River as a service center and Dotsero at the confluence of the Eagle and Colorado rivers as a fuel and water stop. When D&RG pushed its line down the river valley, it fostered a localized timber industry, limited at first to railroad tie production. Within two years, a swarm of tie hacks invaded forests on both sides of the river valley, generating thousands of ties. Initial tie demand was high in 1886 and 1887, the years of peak construction. After D&RG finished the track, intensive production ended, but the railroad retained a few tie hacks to provide stockpiles at strategic points, primarily Minturn and Dotsero.

Besides an appetite for ties, D&RG was the first organization in the Eagle River valley to demand lumber in notable quantity. The railroad required lumber for right-of-way structures and outposts in Dotsero, Minturn, and Castle (renamed Eagle in 1891). Instead of hauling the material into the region, either D&RG established its own sawmills or contracted with entrepreneurs. It remains unknown where the presumed mills operated, although Castle and Minturn are likely as both towns experienced major growth during the late 1880s.

In 1890, increase in the value of silver simulated a significant boom in the mining communities of Aspen, Red Cliff, and Leadville. Demand for lumber and mine timbers rose in parallel, and these communities had an increasingly difficult time satisfying their own requirements because miners and lumber companies exhausted the surrounding forests during the previous ten years. However, D&RG made lumber economical to ship the short distance from Eagle County. In response, a few lumber outfits established operations along the Eagle River where the best stands of trees grew (see Illustration A 2.6). Logging for the purpose of export contracted in 1894 when the Silver Crash impacted mining.

During the late 1890s, factors discussed above stimulated logging, including D&RG's need for tie replacement and major mining revivals at Leadville and Red Cliff. Several mills immediately around Minturn, Eagle, and Wolcott also produced lumber for local demand. At the turn-of-the-century, the J.W. Thorpe and Lumley sawmills operated near Eagle while Jack Hall began running the Armstrong sawmill at Wolcott, where he also owned a saloon.³⁴⁸

It remains uncertain exactly how long the timber industry remained viable in the county. Because the local demand for lumber was limited, the industry relied heavily on D&RG tie needs and the distant mining markets. The industry also required timber reserves, which retreated higher into the mountains and farther from points of access in the river valley. Lumber

³⁴⁸ *Eagle Valley Enterprise* (5/22/03): 1; *Eagle Valley Enterprise* (1/8/04): 4; *Eagle Valley Enterprise* (10/4/07): 1.

companies shipped product to Leadville and Aspen as late as the mid-1910s, but ended by 1920. At that time, the mining industry collapsed and the nation entered a deep depression.³⁴⁹

³⁴⁹ *Eagle Valley Enterprise* (3/6/14) 1.

Section A 3: History of High-Altitude Agriculture, 1860-1960

Period of Significance, 1860-1960

Homesteading, ranching, and farming represent different forms of agriculture, significant as an industry in the I-70 Mountain Corridor between 1860 and 1960. The Period of Significance began in 1860 when settlers established the earliest homesteads in Clear Creek drainage. Homesteading spread throughout the corridor, with ranching and farming following by ten years. The Period ended in 1960, when agriculture was no longer viable after gradual attrition of farms and ranches. Individually, homesteading, ranching, and farming were important during narrower timeframes, largely because they followed a westward progression through the corridor. The timeframes are summarized separately below. The three forms of settlement and agriculture also demonstrate NRHP Areas of Significance: Agriculture, Architecture, Commerce, Community Planning and Development, Economics, Exploration/Settlement, Industry, Landscape Architecture, and Politics/Government. Significance is likely to be local as the three forms of settlement were integral to development, cultivation, land use, and subsistence within the corridor. Some resources could be statewide depending on further research.

Homesteading

In Clear Creek drainage, homesteading began in 1860 when prospectors platted the first homesteads. Homesteading decreased in importance as a contributor to drainage agriculture after 1880 for several reasons. First, the movement slowed substantially because most tillable land had been claimed. Second, many active homesteaders expanded from mere subsistence agriculture into ranching or other businesses. Third, the Colorado Central Railroad began importing agricultural goods at reduced prices, and homesteaders competed with difficulty thereafter.

Homesteading developed along the Blue River in 1865, when a homesteading movement took hold, through 1890. Ranching then began to dominate, and many homesteaders sold to cattlemen, expanded into ranching themselves, or left agriculture altogether. In addition, the Denver & Rio Grande and the Denver, South Park & Pacific railroads provided local markets with inexpensive agricultural products.

Homesteading was important along the Eagle and Colorado rivers from 1870 through 1920. Although ranching and farming dominated agriculture in the drainage by 1890, homesteaders continued settling undeveloped land through 1920.

Homesteading was significant during the above Periods for several reasons. First, it was a primary engine for Euro-American settlement in the corridor. Second, homesteaders were among the earliest settlers to pioneer portions of the mountains lacking resources for mining and logging, and third, they established the foundation for an agricultural industry in the central mountains. Fourth, homesteaders supplied the mining, logging, and railroad industries with food and fodder until other sources of goods became available. Last, homesteading provided many people who had limited means with an opportunity for self-advancement.

Ranching

In Clear Creek drainage, ranching was important between 1870 and 1900 as homesteaders and professional cattlemen established ranches to profit from a strong local market for meat. By 1900, the market contracted because the Colorado Central Railroad provided competition by freighting in inexpensive meat from elsewhere. Ranching thrived along the Blue,

Eagle, and Colorado rivers from 1875, when the first commercial ranches were established, until 1960. Changes in the economy, ranch practices, demography, operating costs, and the overall cattle industry caused ranching to decline.

As an industry, ranching was significant for many of the same reasons as homesteading. In addition, ranching became an economic cornerstone for many communities because it was sustainable, moderating the boom-and-bust cycles of resource extraction including mining and logging.

Farming

The Clear Creek drainage saw little commercial farming, which was not significant as an industry in this region. Farming was active along the Blue River from 1900 until 1920, with most commercial enterprises limited to fodder and grain. A combination of market conditions and climatic extremes severely contracted farming by 1920. Farming occurred along the Eagle and Colorado rivers from 1885, when commercial agriculture began, until 1960. Changes in economy, land use, demography, and operating costs caused farming to decline. Farmers grew a wide range of products including root vegetables, cold weather vegetables, fruit, grain, and especially fodder.

HISTORY OF HOMESTEADING, RANCHING, AND FARMING

Homesteading in the I-70 corridor immediately followed the 1859 discovery of gold on Clear Creek, moving west to the Blue River during the mid-1860s. Ten years later, homesteaders also settled the Eagle and Colorado River drainages. Ranchers and farmers followed homesteaders with the same intent of selling agricultural products primarily to local markets. By the late 1870s, ranching and farming were productive enough to constitute an agricultural industry. Because the high-altitude climate discouraged most forms of agriculture, however, the industry had the greatest presence along the Eagle and Colorado rivers, where the climate was less severe than other segments of the I-70 corridor. Ranching and farming weathered economic cycles and environmental problems, remaining vital until 1960.

Early Agricultural Settlement in the Mountains, 1860-1892

As forms of land use, homesteading, ranching, and farming are integrally tied. Nearly all homesteaders farmed and grazed cattle to some degree, and many ranches and farms either began as homesteads or expanded by absorbing neighboring homesteads. The three forms of land use fostered settlement, formed an agricultural business sector, and provided goods and food that supported mining, logging, and transportation in the mountains. Homesteading, ranching, and farming had similar environmental requirements, relied on the same markets, and were encouraged by a common set of federal land use policies.

Homesteaders, ranchers, and farmers filled different niches in the agricultural sector. Homesteaders were settlers and often pioneers, generating a variety of products primarily for their own consumption, and to sell at local market when surplus existed. Farmers, by contrast, ran businesses that grew crops on a commercial scale for local and statewide markets. The business model for ranching was similar, except that cattle or sheep were the commodity.

In regions founded on agriculture, homesteading, ranching, and farming are perceived as sequential stages of settlement and occupation, often preceding industrial development. In the I-70 corridor, however, resource extraction industries arrived first, with agricultural settlement

following. A clear sequence is difficult to establish because all three forms of land use coexisted for decades. In general, homesteading was first throughout the corridor, continuing into the 1910s, long after ranching and farming were well established. Thus, through a shared timeframe, reliance on the same markets, similarity of products, interaction, and even competition for land, the three types of land use can be considered together.

In the corridor, homesteading was the earliest type of settlement not directly based on resource extraction. The movement began in Clear Creek drainage in 1860 when prospectors established the first homesteads. Georgetown founders George and David Griffith and others settled the drainage floor, quickly securing title to those land tracts not already claimed for mining. During the remainder of the 1860s, miners exhausted most placer gold and increasingly turned to homesteading.

Although some were satisfied with self-sufficiency, most produced surplus goods for local markets. Settlers grazed cattle because the mountain environment was conducive, with cattle translating into dairy and meat. A few also grew produce, which the difficult mountain climate limited to cold-weather crops such as root vegetables, greens, hay, and tree fruit such as apples. Because subsistence agriculture was arduous and uncertain at best in the mountains, some homesteaders supplemented their income with other forms of business. Where distances between towns were great, a few homesteaders advertised their establishments as stage stops and road houses where travelers could billet overnight. For example, Merrill Floyd ran a stage stop at his homestead on the summit of Floyd Hill in eastern Clear Creek County. Other individuals kept frontier mercantiles, some provided blacksmithing, and a few ran post offices.

Homesteading began in Summit County during the late 1860s, similar in pattern to Clear Creek. The discovery of gold near Breckenridge incited one of Colorado's important rushes in 1860, and when the boom declined, some miners resorted to homesteading along the Blue River. They were few in number at first because the region was remote, the local market for products very limited, the climate troublesome, and the growing season short. But as markets improved with logging and mining during the late 1870s, more homesteaders took up claims.

The homesteading movement spread along the Eagle and Colorado rivers in Eagle and Garfield counties during the mid-1870s in response to two factors. In one, the valleys to the east, including Blue and Clear Creek, had already been claimed, forcing pioneers to consider regions farther west. The other was new markets for agricultural products in the central mountains. Between 1877 and 1882, rushes to Leadville, Robinson, Red Cliff, Holy Cross, and Aspen created a strong demand for agricultural products. Further, the Denver & Rio Grande Railroad established its Red Cliff railhead in 1881, granting homesteaders a strategic shipping point for their products. As demand for products exceeded supply, more homesteaders settled the Eagle and Colorado river valleys in response to the market.

One of the most important factors in the central mountain homesteading movement was land that the federal government conveyed at little cost. The government established several programs specifically to encourage settling of the West, primarily with land taken from dispossessed Native American tribes. The Homestead Act of 1862 was designed to expand the Preemption Act of 1841, providing title to 160 acres (quarter section) after five years occupation and payment of application fees. In turn, the Timber Culture Act of 1873 attempted to make barren land attractive for settlement. Homesteaders could buy a quarter section for \$1.25 per acre if they planted forty acres with trees, maintaining them for ten years. The Desert Land Act, passed in 1877, appealed to homesteaders, ranchers, and farmers alike. Individuals could

purchase 640 acres (one section) for \$.25 per acre and demonstrable irrigation improvements within three years.³⁵⁰

Even though these programs made land available, the land required three general conditions for successful homesteading. First, it had to be arable, which meant nearby water and few if any rocks and trees. In the absence of a natural water source, homesteaders often sank wells by hand. Second, the land had to possess gentle topography and a climate that could support at least grass if not other types of crops. Last, the property had to be relatively near a market or shipping point.

By definition, homesteads were small and simple agricultural complexes. Some type of residence, often little more than a rudimentary shelter, was usually the first building erected, and in time, it became the center of the homestead. The most primitive and temporary residences were small dugouts. As the term implies, dugouts were built into hillsides so that only their façades were above grade. Building into a slope simplified construction, minimized building materials, and afforded maximum protection from the elements once the dugout was complete. Once a homesteader incised a chamber of sufficient size into the slope, he usually finished the dugout with locally available materials. Settlers faced dugouts with logs, hand-hewn timbers, rough-cut lumber, or rock masonry. Logs, when used, were either round or squared into timbers by hand with an axe or adz. The homesteaders roofed the excavated chambers with ridge-beams, rafters, decking, and earth. Dugouts were rectangular in shape and had earthen floors and barrel-shaped or front-gabled roofs. Entry doors were narrow, wood plank, and hinged within door frames made of squared hand-hewn logs or rough-cut lumber (see Illustration A 3.1).

The construction of homestead dwellings, ranch houses and farmhouses, may be viewed as a progression, providing insight into the practicality, frugality, and upward mobility of their builders and earliest owners. When resources and time permitted, homesteaders replaced their dugouts with semi-permanent log cabins, in turn replacing these with modest wood-frame houses. Homesteaders sometimes enlarged their cabins but usually replaced them entirely. The early residences were not abandoned in such cases, however, but adapted to other uses. Dugouts became root cellars or pit silos, while original homestead cabins were retrofitted as needed into a variety of agricultural outbuildings. At a minimum, building materials were salvaged for use in new construction.

Homestead residences are vernacular in design in that they were adapted to the local climate and geography. Homesteaders built them from locally available materials, without a professional architect or builder, to meet perceived needs. Most homesteaders possessed a wealth of practical knowledge, and were capable builders despite a lack of formal training. With a can-do spirit, they employed a basic understanding of building principles learned elsewhere. As a result, homestead residences reflect the construction techniques, traditions, and cultural influences passed down through generations, brought west, and adapted to the Colorado frontier.

A variety of factors influenced the construction and form of vernacular residences, as well as outbuildings. The environment was a primary consideration, and homesteaders responded to the climate, topography, soil conditions, availability of water, and other physical characteristics specific to a region. Homestead design was also influenced by the financial resources of their owners, and in turn by the dissemination of popular building techniques, styles, and detailing. As commercial lumber became available, homestead houses were increasingly of wood-frame construction, with multiple rooms, and eventually with stylistic influences and details reflecting homesteaders' tastes and architectural styles then in vogue. For example, some

³⁵⁰ Mehls, Steven F. *The Valley of Opportunity: A History of West-Central Colorado*. Denver, CO: Bureau of Land Management, Colorado State Office, 1988, 113, 115; *Pre-Emption, Homestead and Timber Culture: Information for Those Interested in Securing a Free Home in the San Luis Park, Colorado* [pamphlet, no publisher, no date, on file at Denver Public Library]; Harris, 1993.

houses erected late in the homesteading movement were not constructed solely of on-site materials, but rather with manufactured lumber and other building supplies delivered by railroad and purchased from local retailers. Similarly, later houses increasingly exhibited stylistic detailing made popular by nationwide diffusion of architectural pattern books and magazines. House plans became available through Sears, Roebuck & Company in the late 1890s, and by around 1900, popular magazines including *House Beautiful* and *Ladies Home Journal* influenced design.

Whereas houses sheltered the homesteaders, outbuildings such as barns, stables, and chicken coops accommodated livestock. Settlers usually erected such buildings near the house, but far enough to keep insects and vermin at a distance. Systems of corrals and pens, often fenced with local logs, contained the livestock. Over time, successful homesteaders diversified their agricultural products, and the size and complexity of homesteads increased as a result. Settlers added other outbuildings such as storehouses, milking sheds, grain sheds, hay barns, loafing sheds, smokehouses, potato cellars, and privies. They also sank wells and excavated stock ponds, expanded hay fields, and maintained garden plots.

Although most homesteaders kept at least a few cattle, they were not considered ranchers or cattlemen. A ranch was distinct as a business that bred, grazed, and kept large numbers of cattle as the dominant land use. Because many ranches were in remote locations, they had some commonalities with homesteads and farms, such as small garden plots and livestock other than cattle. Ranching began in the corridor when homesteading was already well-established.

As with homesteading, a market for food associated with the mining and logging industries convinced early cattlemen to try their fortunes in Colorado. They were few in number at first, their herds small, and their ranches concentrated around nascent plains towns. During the mid-1860s, Texas cattlemen discovered the resources offered by the Colorado plains and drove large herds into the region, which became the foundation of a permanent industry. Although entrepreneurs brought small herds into the mountains during the mid-1860s to feed hungry miners, few cattlemen attempted large-scale ranching there because the plains were a more conducive environment. Only after the large cattle outfits subsumed nearly all open grassland did cattlemen move more actively into the mountains.³⁵¹

Several factors fostered major ranch expansion into western Colorado during the 1870s. National demand for beef soared, fostering a beef bonanza. Cattlemen could purchase stock for a few dollars per head, graze and fatten them at little cost, and sell for \$40 to \$50 per head at stockyards in the Midwest. Completion of the Denver Pacific and Kansas Pacific railroads in 1870 provided Colorado ranchers with inexpensive transportation to stockyards, allowing them to profit from the Beef Bonanza. Within Colorado, mining spread throughout the central mountains, creating a sizable regional market in both beef and fodder for draft animals. Because regional demand for beef was so high, nearly all the cattle raised in the mountains were consumed locally, leaving mountain ranchers with little surplus for external markets. Still, some drove cattle overland to Denver. As a reflection of the boom, the number of cattle in Colorado increased from 291,000 in 1870 to 809,000 by 1880. The boom was not limited to cattle alone, as ranchers also brought in sheep primarily for wool but also meat. In 1870, there were less than 20,000 sheep in Colorado, but by 1879, there were 2 million.³⁵²

As ranching operations grew in size, cattlemen recognized the need for an overall statewide association to promote and protect the industry. They organized the Colorado

³⁵¹ Reyher, Ken. *High Country Cowboys: A History of Ranching in Western Colorado*. Montrose, CO: Western Reflections, 2002.

³⁵² Simmons, Laurie R. and Simmons, Thomas H. *National Register of Historic Places, Multiple Property Documentation Form: Historic Ranching Resources of South Park, Colorado*. Denver, CO: Front Range Research Associates, 1999, 4; Stone, Wilbur Fisk. *History of Colorado, Vol. 1*. Chicago, IL: S.J. Clarke Publishing Co., 1918, 512; Mehls, 1988:115; Reyher, 2002.

Cattlemen's Association in 1867, the oldest comparable organization in the United States, and the Colorado Stock Growers' Association in 1871. The organizations coordinated roundups, governed passage of herds through Colorado, established an official branding registry, and hired range detectives to reduce cattle rustling. In 1879, however, government took over brand registry and law enforcement.³⁵³

By 1880, investors with no actual range experience acknowledged the enormous profits to be made from large-scale ranching and entered the industry. English and Scottish capitalists formed companies and poured money into sprawling operations. These companies dominated the plains but limited their presence in the mountains because the high-altitude environment did not support the herd sizes that the outfits preferred. Instead, small and medium-sized outfits remained prevalent in the mountains. Together, the plains and mountain ranchers ushered in a major boom that lasted through much of the 1880s, when beef prices reached record levels.³⁵⁴

Other development allowed ranching to thrive in the high country. Mining and logging continued to spread, strengthening the regional market for beef and fodder. Second, the railroad network expanded in parallel, linking shipping points with markets. In particular, the Denver & Rio Grande and the Denver, South Park & Pacific railroads graded trunk lines through prime grazing land in the Blue and Eagle river drainages. Ranchers could chose from markets including mining towns, Denver, or Midwest stockyards. Dozens of range outfits grazed around 50,000 cattle through portions of western Colorado by the mid-1880s.³⁵⁵

Whereas Clear Creek drainage had a few ranches, the industry swept the Blue, Eagle, and Colorado rivers where open range and clean water were readily available. On the Blue, ranching allowed Dillon to grow into one of the most important towns in the valley. Founded in 1878, Dillon was center to a collection of ranches and homesteads at first supporting mining in the region. In 1882, the arrival of the railroads cemented Dillon's identity as a cow town and regional shipping point for cattle. During the remainder of the decade, additional cattlemen established operations around Dillon, and many were local investors such as A.C. Graff, who applied capital from mining in the Ten Mile Range. In the long run, ranching benefited Dillon as a sustainable industry and, along with the railroads, stabilized its economy. By comparison the population of neighboring Frisco fluctuated wildly with the revivals and busts of silver, while Dillon held steady between around 250 and 300 through the 1920s.³⁵⁶

Ranching followed a similar trend on the Eagle and Colorado rivers. A handful of individuals established the first ranches during the latter half of the 1870s with small operations almost as primitive as homesteads. During the late 1870s, several investors pooled limited financial resources and started large-scale company operations. Henry J. Hermage, Robert Matthews, and W.E. Frost ranged a herd on Brush Creek; W.W. Livingston, R.M. Sherwood, C.M. White C.B. Stone, and J.L. Howard worked along the Eagle River; and A.F. Grundel and Casper Schumm claimed the Gypsum Creek area.³⁵⁷

Ranching gained enough momentum during the early 1880s to constitute an industry, fostering a local economy that supported permanent settlements. Gypsum and Dotsero, were both

³⁵³ Abbott, Carl, Leonard, Stephen, and McComb, David. *Colorado: A History of the Centennial State*. Niwot, CO: University Press of Colorado, 1994 [1982], 170; Whittemore, Loren R. *An Illustrated History of Ranching in the Pikes Peak Region*. Colorado Springs, CO: Gowdy Printcraft Press, 1990.

³⁵⁴ Abbott, et al., 1994:171; Simmons and Simmons, 1999:7-8.

³⁵⁵ Reyher, 2002.

³⁵⁶ Crofutt, George A. *Crofutt's Grip-Sack Guide to Colorado: A Complete Encyclopedia of the State*. Omaha, NE: Overland Publishing Company, 1885 [reprinted by Cubar Associates, Golden, CO, 1966], 88; Gilliland, Mary Ellen. *Summit: A Gold Rush History of Summit County, Colorado*. Silverthorne, CO: Alpenrose Press, 1999, 87; Schulze, Susanne. *A Century of the Colorado Census*. Greeley, CO: University of Northern Colorado, 1976, 1890-8, 1920-13.

³⁵⁷ Stone, 1918, V.1:520.

formalized in 1883 with post offices. The Gypsum Ranch was the seed for Gypsum, attracting approximately thirty other range outfits by 1884. Dotsero began as a homestead community at the confluence of the Eagle and Colorado rivers and quickly attracted its share of ranches. The Hermage ranch near the confluence of Brush Creek and the Colorado was the seed for Brush Creek, which the Post Office Department recognized as Castle in 1885. As with Dillon, the arrival of the Denver & Rio Grande in 1887 cemented the region as a cattle center, and the industry grew significantly. The town of Wolcott became the shipping point for the Eagle River valley, justifying a post office by 1889. Castle became the other loading station, renamed Eagle in 1891 (see Illustration A 3.2). Overall, ranching provided these communities with a level of stability that natural resource extraction could not. Ranching was a sustainable, long-term industry whose sustenance, vegetation and water, were replenished yearly.³⁵⁸

The first cattle in western Colorado were Texas longhorns. Although the animals did well on Colorado's plains, they suffered in the mountains and died in alarming numbers. Ranchers soon realized that the animals were ill suited to the rigorous mountain climate, and calves born during the coldest winter months often perished. Thus, ranchers bred longhorns with Hereford and Durham bulls and abandoned the practice of calving year-round in favor of early spring. These adaptations and hybrid breeds proved successful, and herds began thriving.³⁵⁹

Ranchers also became conversant in their mountain environment. Water and grassland were fundamental, seconded only by weather, and both were limited in the mountains. Herds of profitable size required plenty of both, and ranchers quickly concluded that water was key to controlling grassland. Without water, adjoining dry land was worthless for grazing. As on the plains, ranchers actively secured land with water first, either by filing a homestead claim through the Timber Culture Act or via the Desert Land Act. Although ranchers settled for springs when nothing better was available, they preferred to occupy as much stream-front land as possible. This they found in valleys, which also offered open grassland. Once ranchers secured land with water, they assumed by proximity large tracts of public land. As competition increased between cattlemen, sheep ranchers, and even homesteaders, many cattlemen marked their holdings, including adjacent public land, with fences. Although illegal, this prevented confusion between herds, secured rangeland for cattle, and kept livestock off farmland.³⁶⁰

The latter issue became increasingly important between the late 1870s and early 1890s when cattlemen and homesteaders were alternately hostile and cooperative. They perceived one another as competitors for suitable sites. Ranchers viewed homesteaders as occupying important water sources, while homesteaders fenced their land to keep cattle out, dividing rangeland in the process. Homesteaders and ranchers, however, cooperated on irrigation and road projects. Further, ranchers amassed huge holdings by buying out struggling homesteaders, and, conversely, some homesteaders expanded into ranching and farming by acquiring neighboring operations. Ironically, some cowboys without work became homesteaders.

Physically, ranches followed a development pattern similar to homesteads. A rancher began by building a house or cabin, bunkhouse for cowboys, barn, stable, and corrals. In remote areas, ranchers used local building materials such as logs or rocks, but substituted lumber when transportation infrastructure improved. The ranch house was the center of operations and housed the rancher's family, an office, large kitchen, and communal dining space. The physical

³⁵⁸ Bauer, William H., Ozment, James L., Willard, John H. *Colorado Post Offices: 1859-1989*. Golden, CO: The Colorado Railroad Museum, 1990, 31, 46, 67; Knight, MacDonald and Hammock, L.A. *Early Days on the Eagle: Biographical History of Pioneer Life in Colorado's Eagle River Valley*. Eagle, CO: Knight and Hammock, 1965, 29; Mehls, 1988:119.

³⁵⁹ Reyher, 2002.

³⁶⁰ Abbott, et al., 1994:170; Mehls, 1988:113; Simmons and Simmons, 1999:1.

appearance of a ranch house depended on a combination of environmental and financial factors as well as the needs and vision of the rancher.

Over time, successful ranchers developed complexes to accommodate family and facilitate the ranching operation. A root cellar, smokehouse, well with a pump house or windmill, privy, and perhaps an ice house would be located close to the ranch house. Cooking during warm months often took place in a summer kitchen, a semi-open structure located in close proximity to the ranch house or bunkhouse. Other function-specific buildings and structures comprised the remainder of the complex. Depending on the size of the operation, such infrastructure consisted of barns, stables, loafing sheds, corrals, loading chutes, feed troughs, stock tanks, blacksmith shop or workshop, machine sheds, and an irrigation system with a stock pond. In terms of setting, ranch complexes were located within mountain valleys surrounded by pastures, grazing lands, and timbered slopes. On the range, ranching outfits also maintained watering holes, wells, corrals, and line camps for cowboys working far from the main ranch complex.

Beginning in the mid-1880s, trends forced ranching into transition and ultimately brought the boom to an end. A series of exceptionally severe winters and summer droughts between 1885 and 1887 killed entire herds already weakened from subsisting on overgrazed range. At the same time, the beef bubble burst and prices fell, threatening operations in debt. Many large cattle companies sold holdings at a loss. In the mountains, small and medium-sized outfits grazed fewer cattle because of poor market conditions. Sheep ranchers quickly filled the void on the range, contributing to the problem of overgrazing. Conditions worsened in 1890 when a major drought impacted the entire state. As water sources dried up and grass did not grow, some ranchers surviving previous difficulties finally succumbed. Because of competition for resources, animosity and violence developed between cattle interests and sheep ranchers. All increasingly relied on hay produced by local farmers for winter survival, raising both operating costs and tensions.³⁶¹

While the cattle industry went from boom into decline during the late 1880s, farming followed an opposite trend. The same positive market conditions that fostered the cattle boom early in the decade stimulated a wave of farming across Colorado. In the high mountains, farming began on a diminutive scale because the environment was unsuitable for large-scale agriculture. As the decade progressed, individuals settled the valleys along the Eagle and Colorado rivers to Grand Junction to supply the same market as ranchers. In this belt, the growing season was just long enough for cold weather produce and tree fruit. Many homesteaders in the region expanded their holdings into farms, failed ranchers turned to farming, just as a decline in mining also forced many miners into agriculture. Thus, farming grew as an industry through the decade and into the early 1890s. Farming quickly became locally important because it complimented ranching in bringing economic stability to communities. Like ranching, farming was sustainable as an industry, helping communities to weather the boom-and-bust cycles inherent in extraction industries in the high mountains.

A farm can be defined as a business that grows and harvests crops in commercial quantities for market. Although farmers grew cold weather produce and fruit, the most sustainable crops capable of surviving mountain winters were hay and grain. Farm complexes were similar to ranches in function and layout with facilities supporting crop growth and storage. Because most farms were isolated and had to be self-sufficient, they included arrangements for limited livestock such as cattle, horses, hogs, and fowl.

Irrigation was imperative for farming in the mountains, and farms had systems more sophisticated than those on either ranches or homesteads because their needs were greater. The

³⁶¹ Reyher, 2002.

early systems were primitive. Farmers excavated feed ditches from diversion points on streams and created smaller distribution ditches and gates to flood the fields. These rudimentary ditches seeped and were inefficient, they became silted, and carried inadequate volumes of water. Further, they had to be formally surveyed and required the farmer to acquire water rights, which many were unable to do. For these reasons, farmers increasingly turned to irrigation and ditch organizations for their water during the late 1880s. Some organizations in Eagle and Garfield counties were cooperatives, others for-profit companies, and in Summit and Clear Creek counties, most were connected with the mining industry. For-profit companies typically applied their capital to buy extensive rights and built substantial distributions systems. In so doing, companies helped farming spread from the floors of the principal valleys up and into tributary drainages and elevated land.³⁶²

Mountain Agriculture Perseveres, 1893-1919

By the early 1890s, the pattern of agriculture and associated settlement became evident in the corridor. Homesteading in Clear Creek and Summit counties gave way primarily to ranching. The climate in both counties discouraged commercial farming of anything except hay, which many ranches also produced. In Eagle and Garfield counties, when both homesteading and ranching were well under way, farming rose as an industry. In 1893, several factors created considerable difficulty for ranching and farming. At year's end, the value of silver collapsed, forcing most Colorado silver mines to close. The market for agricultural products imploded, although Clear Creek County's ranches continued supplying the local market. Elsewhere, economic conditions remained dismal throughout the 1890s. Farmers struggled as both demand and prices for produce fell. Many were unable to repay debts and lost their farms to foreclosure. The price of beef dropped below wholesale levels, and many cattle companies that had survived severe winters and range exhaustion left the business. Some ranchers, primarily in Eagle and Garfield counties, survived through diversification. They increased their acreages of pasture land, began to supplement grazing with production of hay and grain, and raised cattle better suited to the mountains. Some favored breeds were Shorthorns, Herefords, Ayrshires, Jerseys, Alderneys, Devons, and Galloways.³⁶³

In contrast to ranching and farming, homesteading increased as a result of the 1890s depression. Miners thrown out of work saw homesteading as a means of subsistence and did not have to travel far from silver towns to find land. Dispossessed farmers came from the Midwest, and European immigrants unable to find employment in cities also arrived. Because most arable land in Clear Creek and Summit counties was already claimed, the movement was greatest in western Colorado. The trouble that plagued ranching and farming, and the concurrent increase in homesteading along the Eagle and Colorado rivers may explain curious trends in population figures for that region. Between 1890 and 1900, the population of Eagle County fell from 3,725 to 3,008, largely due to closure of ranches and farms, and the abandonment of many mines. In contrast, the populations of Eagle, Gypsum, and Wolcott increased slightly. Dillon's population fell from approximately 250 to 200.³⁶⁴

By the late 1890s, the national economy began to recover. Colorado entered a period of industrial growth, and as discussed in the sections on mining and timber, the mountains enjoyed

³⁶² Holleran, Michael. *Historic Context for Irrigation and Water Supply: Ditches and Canals in Colorado*. Denver, CO: University of Colorado at Denver and Health Sciences Center, 2005; Mehls, 1988:140.

³⁶³ Front Range Research Associates. *National Register of Historic Places, Multiple Property Documentation Form: Historic Farms and Ranches of Weld County*. Denver, CO: Front Range Research Associates, 1991.

³⁶⁴ Mehls, 1988:137; Schulze, 1976:1890-3; Schulze, 1976:1900-11.

a major revival. Although the activity restored the markets for agricultural products, farming and ranching did not benefit evenly. Just as farmers prepared to supply the enormous demand for produce, one of the state's worst droughts struck, reducing crop yields. The drought also affected cattlemen and created conditions that permanently changed their industry. In particular, the federal government grew deeply concerned with overgrazing and destruction of forage, which the drought exacerbated. In response, the government moved to regulate. First, the Department of Agriculture began a program of grazing permits in 1899 for land within the Forest Reserves. Second, the General Land Office introduced a similar program on Department of the Interior lands in 1901. Both agencies controlled most federal land in the west, and the programs both reduced herd sizes and limited abuses.³⁶⁵

Cattlemen had little time to adjust before catastrophe struck again. The winter spanning 1902 to 1903 was the worst since the late 1880s, and even though ranchers ranged breeds of cattle suited to the climate, starvation and severe weather killed thousands. As during the late 1880s, the plains were hit the hardest, but mountain ranches suffered as well. When the winter abated, ranchers found that cattle fetched relatively low prices, limiting annual income. Shortly after 1900, five meat packing companies including Swift & Company, Armour, Cudahy, Wilson, and Morris, formed the Beef Trust, conspiring to suppress the value of cattle even more.³⁶⁶

Overall, winter losses, increased regulation, and controlled prices culled more cattle outfits from the business and forced the industry into another transition. In the mountains, small outfits and sheep ranchers filled the void left by the large cattle companies, as they continued to adopt practices pioneered during the previous decades. Specifically, cattlemen reduced their dependence on the open range, balancing herd sizes with the carrying capacity of natural resources on ranch lands. They prepared for winter by irrigating and growing grass, grazing herds on ranch, and adding land holdings. Ranchers also drilled wells and excavated stock ponds to ensure water both on ranch land and the open range. In so doing, cattlemen successfully weathered the 1907 economic recession and enjoyed stability for nearly twenty years.³⁶⁷

Like cattlemen, farmers faced difficulty in the mountains after the late 1890s, but not to the same degree. The winter of 1902 and 1903 damaged fruit trees, and farmers endured crop failures in 1903 and 1904. In addition, farms on marginal land in Eagle and Garfield counties suffered the same trend as enterprises farther north. In particular, poor agricultural practices and the arid climate contributed to soil loss, rendering entire fields infertile in as little as fifteen years. In such cases, farmers had no choice but to move on.³⁶⁸

The National Reclamation Act of 1902, also known as the Newlands Act, softened the problems presented by weather and land. The Act created an administration that built not only local irrigation systems, but also entire large-scale infrastructures. The Bureau of Reclamation administered to diversion, storage, and distribution networks, and in Colorado, the plains and western slope received the most attention. As a result of this effort and existing irrigation systems maintained by local companies, Garfield and Mesa counties became one of the state's important agricultural centers and entered a fruit boom. The festival of Strawberry Days began in Glenwood Springs in 1898 and still continues as the oldest continuous town celebration in the state. Peaches were so successful along the Colorado River between New Castle and Silt that the area became known as Peach Valley. East of Glenwood Springs, Eagle and Garfield Counties

³⁶⁵ Abbott, et al., 1994:178; Mehls, 1988:117; Reyher, 2002.

³⁶⁶ Simmons and Simmons, 1999:14; Stone, 1918, V.1:513.

³⁶⁷ Abbott, et al., 1994:172; Front Range Research Associates, 1991; Simmons and Simmons, 1999:13.

³⁶⁸ Abbott, et al., 1994:176; Stone, 1918, V.1:514.

enjoyed growth as well, and common crops included hay, plums, strawberries, apples, grapes, and pears.³⁶⁹

Both ranching and farming enjoyed prosperity during the latter half of the 1910s. World War I created conditions for a sound national economy and another mining revival. The demand for agricultural products increased due to greater local consumption and to supply Allied forces in Europe. The positive climate encouraged some optimistic farmers to try commercial agriculture in mountain valleys previously considered too high in elevation. With advanced practices, adventurous farmers produced potatoes, cabbage, grain, and hay by 1917 in North, Middle, and South parks, as well as the Blue River valley. The high country farmers were successful at first, but learned some of the hard climatic lessons that the cattlemen suffered in earlier years. The growing seasons were short, winter freezes deep, droughts unpredictable, and thin soils prone to overuse.³⁷⁰

Despite fluctuations and adjustments, ranching and farming continued as important industries along the Blue, Eagle, and Colorado rivers. These sectors moderated decline in logging and mining, stabilizing populations and economies within the corridor. Dillon's population changed little between 1900 and 1920, remaining at around 200 people. Eagle and Minturn grew by around twenty-five percent, both populations increasing from 400 and 480, respectively, to 600 and 620. Gypsum and Wolcott maintained populations of around 410 and 120.³⁷¹

Ranching and Farming Struggles, 1920-1940

Agriculture declined abruptly throughout Colorado in 1920, becoming mired in a long period of stagnation as the nation descended into a post-war depression. In addition, resource extraction industries, especially mining, wrecked the state economy. Markets for agricultural products tightened and prices fell as a result, and more droughts and severe winters reduced crop yields and cattle herds. Inadequate income and outstanding debt pushed ranchers and farmers into insolvency, with many leaving the business. Some farmers focused on subsistence, while many ranchers reduced herds and focused on Denver as their principal market. A study conducted by the Colorado Agricultural College in Fort Collins between 1922 and 1928 characterized cattle ranches in the mountains of Colorado as small, reliant on Denver, and saddled with debt (see Table 3.1).³⁷²

Table A 3.1: Characteristics of Cattle Ranches in the Colorado Mountains 1922-1928

Characteristic	Statistic
Herd Size	800 head (not including calves)
Ranch Area	860 acres to 55,000 acres
Average value of land	\$9.65 per acre
Percent of ranches free of debt	5%
Months of labor per ranch	68-52
Average labor cost per month	\$86 (including value of boarding)
Principal market for cattle	Denver (received approximately 60% of cattle sold)

³⁶⁹ Gulliford, Andrew. *Garfield County, Colorado: The First Hundred Years, 1883-1983*. Glenwood Springs, CO: Gran Farnum Printing, 1983; Abbott, et al., 1994:179, 181.

³⁷⁰ Simmons and Simmons, 1999:15; Stone, 1918, V.1:484.

³⁷¹ *Colorado Business Directory*. Denver, CO: Gazetteer Publishing & Printing Co., 1906:579; *Colorado Business Directory*, 1917:545; Schulze, 1976:1910-11; Schulze, 1976:1920-8.

³⁷² Burdick, R.T., Reinholt M., and Klemmedson, G.S. *Bulletin 342: Cattle-Ranch Organization in the Mountains of Colorado*. Fort Collins, CO: Colorado Experiment Station, Colorado Agricultural College, 1928; Mehls, 1988:156; Simmons and Simmons, 1999:15.

Source: Burdick, R.T., Reinholt M., Klemmedson, G.S. *Bulletin 342: Cattle-Ranch Organization in the Mountains of Colorado* Colorado Experiment Station, Colorado Agricultural College, Fort Collins, CO, 1928.

The 1930s brought no relief to farmers and ranchers, instead delivering them into greater adversity. At the end of 1929, the nation entered the Great Depression. In the agricultural industry, markets for all goods collapsed, creditors recalled loans, businesses dissolved, and thousands of farms and ranches went bankrupt. Those farms and ranches that survived the first years of the Great Depression teetered due to volatile cattle and produce prices, supply exceeding demand, severe winters, and debt. Conditions worsened in 1934 when the severest drought in a century swept the West. The plains became a wind-blown desert and water sources dried up in the mountains, ruining many marginal farms and ranches. Notwithstanding, agriculture in the mountains was slightly better off than the plains because water was available and local markets still existed. Ranchers responded by forming cooperatives, consolidating operations for stability. The Roosevelt administration initiated several programs that provided relief, but until water returned and the economy improved, farmers and ranchers operated at a subsistence level.

Ranching and Farming Declines in Importance, 1941-1960

Water did return and markets finally improved during the early 1940s. Beginning in 1939, the Roosevelt administration, concerned with the conflict in Europe, directed attention to the agricultural industry. This fostered confidence, and when Roosevelt offered Britain direct support in the form of food, the markets for beef and produce awoke. When the United States entered the war at the end of 1941, food production became vital. In the Colorado mountains, farms and ranches returned to solvency, increased output, and contributed to the war effort. The number of operations, however, changed little. Mountain beef and produce fed the workers who harvested raw materials and assembled the machinery for war. Some byproduct goods from mountain ranches, such as leather and wool, went directly to the military.

Agricultural markets remained sound even after the war ended in 1945. But during the 1950s, ranching and farming in the corridor began declining again. Farming practices shifted to large-scale, chemical-intensive methods not suited to the small operations typical of the corridor. Similarly, ranching shifted away from limited herds and range practices over to massive feed lots. Farms and ranches had an increasingly difficult time competing with corporate agriculture in economies of scale. In addition, another drought struck in 1953 and 1954. Many farmers and ranchers either quit, consolidated, or adapted by moving into niche markets. Farmers grew hay for feed lots and fruit for local distributors, while ranchers started cattle for feed lots and raised specialty breeds.

Changes in land use, demographics, and water allocation were other major factors in the decline of ranching and farming in the corridor after World War II. In terms of demography, cities and suburbs drew young people away from agriculture, leaving ranchers and farmers without a younger generation to run family operations. Affordable automobiles allowed unprecedented numbers of people to easily access the mountains. Many came as tourists, others purchased property, and all placed new demands on the land. South Park serves as an example of the rest of the corridor, with ranches and farms increasingly subdivided for residential development, recreation, and automobile tourism. South Park also exemplifies the impacts of water allocation. Cities such as Denver and Colorado Springs assumed rights to key sources of water, either through purchase, condemnation, or eminent domain, leaving less for agriculture.³⁷³

³⁷³ Simmons and Simmons, 1999:18.

Table 3.2 illustrates the trend that farming and ranching followed in the corridor after World War II. The number of farms declined by more than thirty-five percent in Eagle, Garfield, and Summit counties, and by more than fifty percent in Clear Creek County. By 1960, ranching and farming in the corridor diminished to the point where the industry was no longer viable. Today only a few active ranches remain, primarily in Eagle and Garfield counties, remnants of a defunct industry.

Table A 3.2: Farm Distribution in Clear Creek, Eagle, Garfield, and Summit Counties 1945-1960

County	1945	1950	1960
Clear Creek	23	26	10
Eagle	256	235	166
Garfield	831	781	532
Summit	47	42	34

Source: U.S. Census of Agriculture 1945, 1950, 1960.

Section A 4: History of Electric Power Generation, 1883-1962

Introduction

The I-70 Mountain Corridor was a center of electric technology and generation. Direct current hydro-facilities built at the Kohinor Mine near Lawson in 1883, and at Georgetown in 1886, were among the earliest power plants in the Rocky Mountains. A third plant erected at Georgetown in 1892 contributed to the development of alternating current when the technology was still experimental. The Shoshone Plant, built in Glenwood Canyon in 1907, anchored an advanced grid linking the central mountains between Glenwood Springs and Denver. The Shoshone Plant and several facilities at Georgetown presently remain in service, while remnants of numerous other power plants can be found throughout the corridor. These plants and their grids changed the course of development within the corridor by replacing steam power, and kerosene and gas lighting with more efficient, inexpensive energy. The new form of energy lowered the costs of industry and business and dramatically improved quality of life. Electricity ultimately allowed residents and businesses to modernize at the same pace, and with the same technology, as more urbanized centers. The plants and grids also participated in the overall development of electrical machinery and systems. Through its power plants, introduction of current types, and coordination of service, the local power industry provided examples imitated by engineers elsewhere.

Period of Significance, 1883-1962

In terms of historic resources, electrical generation was significant in the corridor between 1883 and 1962. In 1883, the Kohinor & Donaldson Consolidated Mining Company built the corridor's first power plant near Lawson in Clear Creek County. Over time, the number and size of power plants grew until the early 1910s when most were drawn into a unified grid connecting the corridor. The Central Colorado Power Company, succeeded by Public Service, assumed control over the grid and gradually culled duplicate and inefficient plants during the 1920s and 1930s. The Period ends in 1962, more than fifty years before this report was produced. A little later during the 1960s, Public Service modernized the grid, replacing aging components with new equipment at some facilities. This does not preclude eligibility if a resource retains character-defining attributes conveying its significance from the Period. If a resource is less than fifty years old, it may qualify for nomination under a later Period of Significance as time passes and this context is updated. The resource can also be evaluated under NRHP Criterion Consideration G, recognizing exceptionally important properties that achieved significance within the last fifty years.

Evolution of power generation in the corridor was not a monolithic movement, but rather separate developments in three different regions. The extent of the electrical systems and their associated historic resources define each region: Clear Creek County, Summit County; and the Eagle and Colorado rivers in Eagle and Garfield counties. The individual power industries were shaped locally, had their own chronologies, and responded uniquely to broad trends in effect throughout the corridor. Because of this, power generation in each region was significant during narrower timeframes summarized below. Applicable Areas of Significance include Architecture, Economics, Engineering, Industry, and Invention, with some more relevant in certain regions than others. Level of significance is primarily local, although some resources may be statewide or national, depending on further research.

ELECTRIC POWER IN CLEAR CREEK DRAINAGE, 1883-1962

Electric power generation in Clear Creek County (Tables 4.1 and 4.2, and Illustrations A 4.1 and A 4.2) was significant during Period of Significance 1883 through 1962. The first power plant, one of Colorado's earliest, went into service near Lawson in 1883. The Kohinoor & Donaldson Consolidated Mining Company designed the plant primarily for in-house use, but investors dedicated the 1886 Georgetown facility for broader municipal service. Three years later, another powerhouse at Georgetown became in some ways more seminal as a foundation for a primitive subscription-based grid. At first, service was limited to electric lighting in Georgetown. Investors wanted the mining industry throughout western Clear Creek valley to adopt electricity for mechanical application, but the technology was not yet ready. On premise that improvements would shortly be realized, local experts built several more power plants during the early 1890s. Further, they began experimenting with alternating current (AC), even though it was not well understood, because the current could be readily transmitted throughout the valley. Experiments proved successful with AC current used for lighting and small motors, although the technology was still not completely applicable to mining. Regardless, demand increased enough through the decade to foster additional power plants and expansion of service.

By the turn-of-the-century, manufacturers finally developed AC motors capable of meeting the needs of mining, stimulating a power plant construction boom in Clear Creek valley. The valley's two principal electricity providers added several plants and enlarged their grids, while a few important mines built their own generators for in-house consumption. Between 1900 and 1910, Clear Creek reached its peak in number, size, and diversity of electrical systems, before declining. The principal providers expanded until they saturated the local market, just as demand contracted with a decrease in mining. When generating capacity exceeded demand, providers retired several plants and cut rates, eroding their profitability. The rate reduction, however, saved operating costs for mining companies, prolonging the industry's local viability.

In 1910, the Central Colorado Power Company completed its long-distance transmission line from the Shoshone Plant to Denver. The line passed through the county and tied into the principal providers, drawing them into a larger electrical grid. Because the providers were able to sell surplus power to Central Colorado instead of retiring redundant plants, the power generation industry entered a low-level stability that lasted into the 1910s. In order to monopolize the region, Central Colorado, which became the Colorado Power Company, bought providers in the county. Colorado Power closed several plants and merged with Public Service. Only one plant in Georgetown remained in service by the 1930s, providing the county with most of its needs, while the Public Service grid contributed the remainder. In 1964, Public Service built the first new plant in the county since 1907 above Georgetown and began modernizing the county's grid. By 1970, the provider replaced most major electrical facilities, leaving only the Georgetown plant and smaller aspects unchanged.

Table A 4.1: Clear Creek County Power Grid Chronology

Year	Company	Power plant
1886	M.T. Morrell organized the <i>Electric Light Co.</i> as the first provider in Clear Creek County	Morrell builds a small hydropower plant at Georgetown
1886	<i>Green & Clear Lakes Co.</i> organized to buy water rights for power and milling	The company was exclusively interested in water, but became important in electric generation later (see below)
1888	Morrell suspends service due to competition for lighting from the gas company.	Morrell moves his machinery to Golden.
1890	The <i>Georgetown Electric Co.</i> became the second provider in the county.	The company builds a small DC hydropower plant in Georgetown.
1891	George Hall organizes the <i>Electric Light & Power Co.</i> to serve Georgetown.	The company builds the <i>George Hall plant</i> at the Hall Sampling Works.
	Investors form a partnership to provide Idaho Springs with power. The organization becomes the <i>Seaton Mountain Electric Light, Heat & Power Co.</i> around 1895.	The company builds the <i>Idaho Springs hydropower plant</i> at Idaho Springs.
1892	The <i>Georgetown Electric Co.</i> expands service.	The company adds an AC generator, among the earliest AC plants in the state.
1893	The <i>United Light & Power Co.</i> formed by merger of the <i>Georgetown Electric Co.</i> , <i>Electric Light & Power Co.</i> , and <i>Georgetown Gas Company.</i>	The company operated two plants. It inherited the <i>George Hall plant</i> and built anew the <i>Georgetown hydropower plant</i> in Georgetown.
1895	Idaho Springs investors formalize their organization as the <i>Seaton Mountain Electric Light, Heat & Power Co.</i>	The company continues running the <i>Idaho Springs hydropower plant.</i>
1899	<i>United Light & Power Co.</i> installs a three-phase AC system to Silver Plume.	The company adds AC equipment to the <i>Georgetown hydropower plant.</i>
1900	The <i>United Light & Power Co.</i> expands capacity.	The company builds a new hydro and steam plant in Georgetown, and extends three-phase AC service to Lamartine. The company now operates the two <i>Georgetown plants</i> and the <i>George Hall plant.</i>
1901	The <i>Cascade Electric Co.</i> was organized to provide power to the Idaho Springs area.	Cascade Electric wholesaled power from United Light & Power's Lamartine substation.
	The <i>Seaton Mountain Electric Light, Heat & Power Co.</i> plans an extensive grid to serve the valley.	Seaton Mountain Electric buys and rebuilds the 1891 <i>Idaho Springs plant</i> and builds the <i>Seaton Mountain hydropower plant</i> two miles below town.
1902	<i>United Light & Power Co.</i> continues serving upper Clear Creek valley.	The company operates its Georgetown plant and buys <i>Green & Clear Lakes Co.</i> for water rights.
	<i>Cascade Electric</i> and <i>Seaton Mountain Electric</i> served lower Clear Creek valley.	Seaton Mountain operates two plants and buys the <i>George Hall plant</i> , which burns.
1906	The <i>United Hydro Electric Co.</i> formed by a merger of <i>United Light & Power Co.</i> and <i>Cascade Electric</i> for power and <i>Green & Clear Lakes Co.</i> for water.	United Hydro Electric operates its <i>Georgetown plant</i> and serves all upper Clear Creek and customers in the lower valley.
	<i>Seaton Mountain Electric Light, Heat & Power Co.</i> continues service to the Idaho Springs area.	The company operated its <i>Idaho Springs</i> and <i>Seaton Mountain plants.</i>
	John J. White organizes the <i>Two American Sisters Mining, Milling, Power & Electric Company.</i>	White built the <i>American Sisters AC plant</i> several miles north of Georgetown to provide power for the American Sisters Mine and central valley.
1907	White expands service to central valley	White operates the <i>American Sisters plant.</i>
1908	White begins service to Empire.	White operates the <i>American Sisters plant.</i>

Year	Company	Power plant
1910	The Central Colorado Power Co. begins service in Clear Creek County.	The company completes a transmission line to the county in 1910 and builds the Idaho Springs Substation to distribute power.
	W.E. Renshaw leases the American Sisters plant near Georgetown.	Renshaw links the plant with the Seaton Mountain system.
1911	The Seaton Mountain Electric Light, Heat & Power Co. reorganizes as the Boston-Colorado Power & Water Co.	The Boston-Colorado company operates the Seaton Mountain plant.
1913	The Colorado Power Co. buys the bankrupt Central Colorado Power Co.	The Idaho Springs Substation continues distributing power.
1915	The American Sisters company went bankrupt.	The American Sisters plant was sold at auction.
1916	The Boston-Colorado Power & Water Co. reorganized as the Gem Electric Co.	Gem Electric operates the Seaton Mountain plant.
	The Colorado Power Co. buys control over the United Hydro Electric Co., maintaining the company as a subsidiary.	United Hydro Electric maintains the Georgetown plant.
1917	The Gem Electric Co. is purchased by the Colorado Power Co. and dissolved.	The Seaton Mountain plant is closed.
1924	<i>Public Service Co.</i> merged with the <i>Colorado Power Co.</i>	The companies joined to increase capacity and diversify power sources.
	<i>Public Service Co.</i> absorbed <i>United Hydro Electric.</i>	The <i>Idaho Springs Substation</i> distributed power from the Shoshone plant. <i>Public Service</i> continued to operate the <i>Georgetown plant</i> . No other power plants contributed to the grid.
1926	C.L. Brown enlarges the American Sisters plant.	American Sisters becomes known as the Pirie plant.
1964	<i>Public Service Co.</i> builds Cabin Creek pump storage plant.	The plant was built and recycled water.

Table A 4.2: Independent Power plants in Clear Creek County

Power plant	Builder	Operators	Equipment	Built	Retired
Bertha Mill (at Idaho Springs)	<i>Bertha Mining Co.</i>	<u>1901-1904: <i>Bertha Mining Co.</i></u>	DC hydro	1901	Ca. 1910
Peck (at Empire)	Frank Peck	<u>1900-1901: <i>Frank Peck</i></u> <u>1902: <i>Empire Power & Light</i></u>	Dynamo, gas engine	1900	Ca. 1910
Kohinoor Mine (at Lawson)	<i>Kohinoor & Donaldson Consol. Mining Co.</i>	<u>1883-1901: <i>Kohinoor & Donaldson</i></u>	DC hydro	1883	1910s
Newhouse Tunnel (at Idaho Springs)	<i>Argo Mining, Drainage, Transportation & Tunnel Co.</i>	<i>Argo Mining, Drainage, Transportation & Tunnel Co.</i>	Unknown	1905	1910s
Stanley Mill (at Spanish Bar)	<i>Consolidated Stanley Mining Co.</i>	<u>1890s-1902: <i>Consol. Stanley Mining Co.</i></u> <u>1902-1907: <i>Stanley Consol. Mining & Milling Co.</i></u> <u>1907-1920: <i>Stanley Mines Co.</i></u>	AC hydro	1890s	1910s
Sydney Tunnel			DC hydro	1906	1910s

Note: exact retirement years are uncertain, and general timeframes were estimated from archival sources.

Beginning of Clear Creek Electric Grid, 1883-1905

Electrical technology was still in an experimental state during the first half of the 1880s. Thomas Edison had only recently pioneered its brilliance for lighting, while industrial applications remained theoretical. As the decade progressed, however, electrical experts made great strides in generation, circuitry for lighting, and development of practical motors for small mechanical appliances. The technological improvements rendered electricity economically accessible to greater numbers of consumers. Initially, electricity was mostly used for municipal lighting, while industry only tepidly adopted it for motive power. Industry already had steam equipment in place, understood that technology well, and was unwilling to junk costly machinery for unproven motors. Further, motors were unable to run many types of machinery, and engineers were not versed in their mechanics, circuitry, and adaptation for motive power.

Electricity spread quickly in the eastern states as improvements continued, taking hold more slowly in the West. Municipalities had the greatest interest because electricity solved the chronic problem of poor lighting. During the 1880s, nearly all of Colorado was illuminated by kerosene lamps and candles, with gas lighting the only alternative. However, high gas system costs limited use to the largest and wealthiest towns. Gas systems required coal gasification plants, mountains of fuel coal, distribution plumbing, and maintenance staff. Thus, municipalities looked to electricity for its promise of better lighting to more consumers at less cost.

Like gas systems, however, electric lighting was not without initial investment. The new energy source depended on a power plant, electrical equipment, transmission and distribution lines, and light bulbs, all at great cost. In overview, the power plant generated electricity, with high-pressure water jets turning dynamos in hydro plants, and steam engines turning the dynamos in steam plants. Substations converted the electricity for transmission, power lines carried it through service area, more substations adjusted the current for use, and distributions lines sent it to consumers. Due to complexities of generating power, the systems and their buildings were usually designed by professional engineers and assembled with manufactured materials and equipment. Most designs were unique, customized to site-specific environment, climate, topography, anticipated demand, and distribution of consumers.

In Colorado, it was mining communities and their resident investors that possessed the necessary capital, and they began building power plants during the 1880s and early 1890s. Most plants were small, hydroelectric facilities generating direct current (DC). Investors in mining communities not only funded power plants for lighting, but also hoped to reduce high energy costs faced by their industry. Like most industrial sectors, mining ran on steam power, which was expensive in the mountains. Boilers and steam machinery had to be hauled to the mines, and a continuous supply of coal freighted up from the plains. Motors powered by locally generated electricity had the potential to reduce this overhead and replace some types of mining machinery. But the mining industry responded slowly. The initial system cost was too great for most companies, the technology not primed for mining applications, and engineers had few if any design templates to follow. As a result, lighting continued to be electricity's principal use through the late 1880s, although power plant investors gambled that it would become practical for mining within a short time, as proven in Clear Creek County.

Georgetown was among the earliest mining towns in Colorado to receive an electrical system. In 1886, M.T. Morrell organized the Electric Light Company, built a tiny DC hydro-plant supplement to the Clear Creek Mill, and began providing service at year's end. Even though the benefits of electricity were well known, he met with only qualified success due to a significant oversight. The town already had a contract with Charles Fish's Georgetown Gas Company. Fish was a well-respected local banker, mining investor, and community figure.

Newcomer Morrell struggled against Fish for a year, trying to gain a foothold, but acceded and packed his plant to Golden in 1888. Although Fish promoted his gas system, growing interest in electricity ensured his success was temporary. In 1890 local interests established the Georgetown Electric Company and built a DC hydro-plant around an existing waterwheel at the Litchfield Millsite. The following year, Electric Light Company returned and finally gained a foothold through local mining magnate George W. Hall. Confident in the future of electricity, Hall provided capital, reorganized the firm as the Electric Light & Power Company, and donated a site adjacent to his Hall Sampling Works. The George Hall plant, Georgetown's second, provided momentum for real growth in electric service.³⁷⁴

Although Georgetown enjoyed the status of two power plants by the early 1890s, a rarity among mountain communities, it conceded the title of first in the county to Lawson. During the early 1880s, Alfred Rickard was manager of the Kohinoor & Donaldson Consolidated Mining Company, a British outfit owning several of the best mines in lower Clear Creek valley. The company operated the Champion Mine on Bellevue Mountain, the Donaldson on Kelly Mountain, and a mill at Spanish Bar. The company also worked the Kohinoor at Lawson, the most advanced of the properties. Alfred, brother to famed mining engineer Thomas A. Rickard, was professionally trained and highly progressive and immediately saw the potential offered by electricity. Well in advance of the rest of the mining industry, he installed one of the earliest electrical plants in the Rocky Mountain states at the Kohinoor in 1883. The plant energized lighting circuits primarily in the mine buildings and stations underground and secondarily in Lawson. While the Kohinoor plant was the county's first, it was intended to be largely a company affair. The two plants in Georgetown, in contrast, were intended as the foundation for a countywide grid.³⁷⁵

Before the county could realize widespread service, experts had to reconcile problems with the technology, specifically current type. As designed, the Kohinoor plant and Georgetown's two power companies generated DC current for lighting and to run motors for industrial applications. DC current was the convention largely because all commercial generators, circuitry, and lights operated with that type of electricity. During the early 1890s, engineers also experimented with alternating current (AC), and, although superior in theory, limitations in AC equipment slowed its adoption. The principal problem the two currents posed to Georgetown interests was that neither was well suited for mining. DC current was able to run the motors required for mining, but could only be transmitted several miles before suffering a debilitating power loss. Given this, DC current had to be used near the point of generation, while most mines were distant from Power plants. In contrast, AC current could be transmitted for dozens of miles, but AC motors were unable to start and stop under load, a capacity required by mining machinery. Most mining companies did not immediately embrace electricity as a result, reinforced by their investments in costly steam equipment (see Illustration A 4.3).³⁷⁶

Despite these problems, the demand for electricity continued growing in Clear Creek County during the early 1890s. The economy was sound because the high value of silver stimulated mining, and money was available for service subscriptions and equipment. The populations of Georgetown, Silver Plume, and Idaho Springs were sophisticated and sought modern amenities such as lighting. Also, machine shops and mills close to the powerplants increasingly installed motors to power constantly rotating appliances. In response, investors

³⁷⁴ *Colorado Miner* (7/31/86): p3 c1; *Georgetown Courier* (8/8/91): p3 c2; Gidlund, H.F. "Public Service Co. of Colorado: History and Plant Information." *Manuscript WH 1367, Box 1, Folder FF5*, Denver Public Library. 1925; Leyendecker, Liston E., Bradley, Christine A., and Smith, Duane A. *The Rise of the Silver Queen: Georgetown, Colorado, 1859-1896*. Boulder, CO: University Press of Colorado, 2005, 250.

³⁷⁵ *Colorado Mining Director, 1883*. Denver, CO: The Colorado Mining Directory Co., 1883, 147.

³⁷⁶ Twitty, Eric. *Riches to Rust: A Guide to Mining in the Old West*. Montrose, CO: Western Reflections, 2002, 222.

moved to not only meet the immediate need, but also to prepare for the huge increase in demand that AC current experts forecast. The early 1890s thus saw a small wave of electric power projects in the county.

Local investors at Idaho Springs built a combination hydropower and steam plant in 1891 to provide lower Clear Creek valley with electricity. The following year, the Georgetown Electric Company installed the county's first AC generators in its George Hall facility and began transmitting power to Silver Plume, initially for lighting. The plant's DC equipment still provided local service. In 1893, Frederick P. Dewey brought Georgetown's utility companies together and established a primitive electrical grid. Dewey, mining investor and cashier at the Bank of Clear Creek County, convinced the Electric Light & Power Company, Georgetown Electric Company, and Georgetown Gas Company to consolidate as the United Light & Power Company. The organization operated the George Hall facility, built another AC powerhouse in Georgetown, and continued running the Litchfield plant. The emphasis on AC generation was significant because the technology remained in an experimental state. Forecasting the adoption of AC current, Dewey arranged to provide service to both Silver Plume and the Lamartine Mine, around five miles east of Georgetown and leased by Lafayette Hanchett. The deal with Hanchett was both strategic and symbiotic. Hanchett enthusiastically supported United Light & Power's move toward AC power because he could reduce the use of steam and lower his operating expenses. At the same time, Dewey realized that a substation built at Lamartine could serve as a platform for service to the eastern portion of the valley. In preparation for competition, W.E. Renshaw and other Idaho Springs investors meanwhile formalized their partnership as the Seaton Mountain Electric Light, Heat & Power Company in 1895 or 1896.³⁷⁷

At the turn-of-the-century, electrical equipment manufacturers finally made the breakthroughs necessary to render AC current practical for the mining industry. First, they began producing three-phase motors that could start and stop under load. Second, engineers developed an AC/DC converter that allowed long-distance AC current to be used with DC motors. Although mining companies were unwilling to junk serviceable steam machinery, they did switch when replacing worn equipment, with others incorporating electricity when designing new surface facilities. Thus, demand amid mines and mills soared, and the two providers stood ready to meet the need.³⁷⁸

United Light & Power campaigned to increase its capacity and reliability for mining. The company extended a three-phase line to Silver Plume in 1899 and a similar one to Lamartine the following year. With demand higher than ever, United Light & Power built a new AC hydropower plant at Georgetown with a standby steam engine for winter freezes (see Illustration A 4.4). The company retired the George Hall plant. In 1902, the company bought the Green & Clear Lake Company, damming anew or improving Murray, Silver Dollar, Naylor, Green, and Clear lakes to provide adequate water for its powerhouses.³⁷⁹

Lower Clear Creek valley, lagging behind Georgetown, suddenly became a center of electrical development. W.L. Bush was well acquainted with the promise of electricity as operations manager for the Kohinoor & Donaldson Consolidated Mining Company, which still ran the small generator installed in 1883. He and Hanchett rallied other investors in the Cascade

³⁷⁷ "Dates of Original Construction or Rebuilds." *Manuscript WH 1367, Box 1, Folder FF13*, Denver Public Library. 1938; "Electricity in the Clear Creek County (Colorado) Mines" *Mining Reporter* (1/16/02): 96; *Georgetown Courier* (8/15/91): p3 c2; *Georgetown Courier* (4/14/93): p 3 c 5; "History of the Company." *Manuscript WH 1367, Box 1, Folder FF10*, Denver Public Library. 1935; Leyendecker, et al., 2005:250.

³⁷⁸ Twitty, 2002:23.

³⁷⁹ Baker, James H. *History of Colorado*. Denver, CO: Linderman Co., Inc., 1927, 725; Colorado Power Company. "General Description of Reservoirs, Pipe Lines, Generating Stations, and Substations and Transmission Lines" *Manuscript WH 1367, Box 1, Folder FF55*, Denver Public Library. 1920, 4; *Georgetown Courier* (11/18/99): p5 c2; *Georgetown Courier* (5/26/1900): p3 c4; Gidlund, 1925; "Mining News" *Mining Reporter* (10/25/1900): 253.

Electric Company in 1901 to wholesale electricity from United Light & Power. Through Cascade Electric, United Light & Power pursued Dewey's strategy of using the Lamartine substation as a platform for a line to Idaho Springs, enlarging its service area. Alarmed at direct invasion of their territory, Renshaw and the Seaton Mountain company principals moved to wire a grid almost as extensive as United Light & Power. The company purchased the 1891 Idaho Springs powerhouse and enlarged it with AC dynamos, built a second hydro-facility several miles east of town, and planned a third, massive station, never built, at the base of Floyd Hill. The company presented Cascade Electric with stiff competition and strung distribution lines to mines throughout the area.³⁸⁰

The largest of those mines were not interested in service because they already had their own generators. J.E. Bowden installed a small hydro-plant at the Stanley Mine during the late 1890s, and the Bertha Gold Mining Company did likewise near its mine in Elkhorn Gulch in 1901. These two outfits curiously invested in costly new dynamos at a time when service from one of the common providers seemed inevitable. The companies were unwilling to wait and see if service would actually be forthcoming, and engineers relished having their own in-house plants. Further, the owners of the Stanley entertained the idea of establishing their own power company and went as far as providing service to some of Spanish Bar. The Kohinoor company's initial relationship with Lawson served as a model.

Despite their competition, both large power providers overlooked the town of Empire. Frank Peck, Empire pioneer and mine owner, built a small powerhouse around the waterwheel of an old mill, beginning service in 1900. The plant was so small that it could be driven by a gasoline engine kept on standby for freezes. In 1901, Peck formalized his service as the Empire Power & Light Company and saw his customer base slowly grow as stodgy mine owners gave in to electric power.³⁸¹

With four power plants in the county by 1902, not including Empire and the Stanley, Bertha, and Kohinoor mines, generation capacity threatened to exceed the customer base. The United Light & Power interests and Idaho Springs companies aggressively solicited contracts, saturated immediate markets, and eyed each other's territory. United Light & Power pushed hardest, in part because capitalists involved in the Bank of Clear Creek County purchased the organization and sought immediate financial return. United Light & Power tightened its relationship with Cascade Electric in 1902, enlarging its power plant, and extending its territory to Black Hawk through the Cascade Electric system. This irked the Seaton Mountain company, which bought the idle George Hall plant to gain a foothold in United Light & Power territory. The company even applied to City Council to provide service to Georgetown, but before Seaton Mountain was able to operate the George Hall plant, it mysteriously burned. The Seaton Mountain company conceded defeat in the upper valley, although dominated the lower valley and provided electricity to some customers in the upper valley.³⁸²

Even though electricity was widely available through subscription, mine owners continued adding facilities. Samuel Newhouse, funded by the Argo Mining, Drainage, Transportation & Tunnel Company, built a plant in 1905 to power the Newhouse Tunnel and associated mines. The tunnel, around two miles long, served as a deep haulageway for well-developed mines such as the Gem and Sun & Moon. The electric locomotives used to pull ore

³⁸⁰ "Acquisitions and Divestitures since 1939." Manuscript WH 1367, Box 1, Folder FF15, Denver Public Library. 1966; Gidlund, 1925; History of the Company, 1935; "Mining News" *Mining Reporter* (5/30/01): 361; *Silver Standard* (3/9/01): p3 c4.

³⁸¹ *Colorado Mining Directory, 1901*. Denver, CO: Wahlgreen Printing Co., 1901, 506; Harrison, Louise C. *Empire and the Berthoud Pass*. Denver, CO: Big Mountain Press, 1964, 391.

³⁸² "Colorado Power Company, Plant Information." Manuscript WH 1367, Box 1, Folder FF54, Denver Public Library. 1925, 2; Baker, 1927, V.2:725; *Georgetown Courier* (9/6/02): p 1 c5; Gidlund, 1925; "Mining News" *Mining Reporter* (2/20/02) 211; "Mining News" *Mining Reporter* (6/19/02): 583; "Mining News" *Mining Reporter* (10/9/02): 296.

trains, Gem's motorized equipment, various electric pumps, and lighting constituted such a demand that Newhouse decided his own generator would be less costly than subscription service.³⁸³

Newhouse was among the last mine operators to install an independent powerplant. As competition between the common providers increased, rates fell to the point where subscription was the most economical means of securing electricity. Further, the service was reliable and required no upfront capital. While mine and mill operators benefited from the situation, United Power & Light, Cascade Electric, and the Seaton Mountain company suffered from dwindling income. Such a trend was unsustainable, with competition forcing adjustment in the county's power industry.

Consolidation and Contraction, 1906-1920

The economic outlook for Clear Creek County's power companies was not bright in 1906. Due to competition and loss of market shares to independent plants, profits declined. The Seaton Mountain company closed its Idaho Springs steam plant but held fast to its hydropower facility below town. Georgetown interests consolidated the companies associated with their grid in an attempt to streamline overhead. F.P. Dewey, C.J. Nicholas, and Silver Plume investor C.S. Desche represented both United Light & Power and water provider Green & Clear Lakes Company. W.L. Bush and Lafayette Hanchett represented Cascade Electric. All joined forces as the United Hydro Electric Company in 1906. With some refinancing and retirement of the Cascade plant, the new organization was better equipped to provide service in a profitable manner.³⁸⁴

The power industry subsequently entered a period of temporary stability leading to slow decline. The problem was that the power industry depended on mining. While many companies increasingly replaced worn steam equipment with electric appliances, exhaustion of ore bodies forced a number of operations to suspend. Mine closures outpaced replacement of machinery in the upper valley, and demand decreased. As a result, both the Seaton Mountain company and United Hydro increasingly relied on the lower valley for income. Business was sufficient to keep the Seaton Mountain company's single plant and all the United Hydro facilities running at capacity as well as supporting one last venture. In 1906, John J. White became interested in the American Sisters Mine near Lawson, using it as a platform for a power plant. He organized the Two American Sisters Mining, Milling, Power & Electric Company to generate electricity for the mine and serve other customers in the central valley. In concentrating on Idaho Springs, Lamartine, Georgetown, and Silver Plume, the county's principal providers had missed an important customer base in the central valley, which White captured. In 1907, he completed an AC power plant on the Wilson & Cass mill site several miles north of and downstream from Georgetown, enlarging a reservoir there. Once White finished the plant in 1908, he made inroads in nearby Georgetown and began service in Empire.³⁸⁵

A combination of factors pushed the county's power industry into another major transition period around 1910. The Central Colorado Power Company was completing one of the state's largest power plants, in turn altering Clear Creek's grid. In 1906, the company began building a massive hydro-facility at Shoshone Falls near Glenwood Springs with the intent of

³⁸³ "The Newhouse Tunnel" *Summit County Journal* (8/5/05): 2.

³⁸⁴ "United Hydro Electric Company - Colorado Power Company." *Manuscript WH 1367, Box 1, Folder FF78*, Denver Public Library. 1941; *Acquisitions and Divestitures*, 1966; Baker, 1927, V.2:725; *Georgetown Courier* (1/20/06): p4 c5; Gidlund, 1925; "Mining News" *Mining Reporter* (2/1/06): 117.

³⁸⁵ *Georgetown Courier* (6/2/06): p1 c1; *Georgetown Courier* (6/8/07): p1 c1; *Georgetown Courier* (11/28/08): p5 c5.

extending a transmission line to Denver and providing power to mining districts in between. The company planned to tie into systems in Leadville, Dillon, and Clear Creek County, provide power when needed, and otherwise buy surplus for the Denver market. The company finished its transmission line, installing a large substation in Idaho Springs during 1910. Central Colorado then tied into the United Hydro system, which was both an economic and morale blow to the Seaton Mountain company. Not only did Central Colorado build the substation in Seaton Mountain's territory, but Seaton Mountain now had to cooperate with United Hydro if it wanted to contribute surplus power to the grid. Although the Central Colorado company presented competition and had the potential to depress rates further, its presence was not entirely unwelcome. Should the local market contract further, Central Colorado was an insurance policy for United Hydro and Seaton Mountain company because it offered them income for their extra electricity. Most customers stayed with their existing service arrangements in the meantime.³⁸⁶

The mining industry was the most important factor forcing electric providers into transition during the 1910s. Ore production declined after a spike in 1902, and although the mid-1910s saw a brief revival, continued mine closure eroded the customer base. John J. White's Two American Sisters company was the first adjust. In 1910, White left the field, leasing the American Sisters plant to Renshaw, who tied the system into the Seaton Mountain grid. But Seaton Mountain company was in trouble, directors reorganizing it as the Boston-Colorado Power & Water Company in 1911. Although Central Colorado never depended exclusively on Clear Creek County, the decline of mining there contributed to its bankruptcy in 1913. The decline was symptomatic of a larger trend throughout Central Colorado's territory. The company predicated its finances on the mining industry and was unable to meet its debt obligations when the decline became widespread. Within a year, eastern investors purchased Central Colorado and reorganized as the Colorado Power Company.³⁸⁷

When mining in Clear Creek enjoyed a brief revival due to World War I, Boston-Colorado Power and United Hydro took advantage. Suspecting the revival was only temporary, they decided to dispose of their interests while the demand for power was stable. In 1916, Bush, Desche, Hanchett, and other capitalists sold United Hydro to the Colorado Power Company, which maintained it as a subsidiary. At the same time, Norman B. Reed bought Boston-Colorado Power and reorganized as the Gem Electric Company, named after the Gem Mine, the largest single consumer. Reed held the company for a year before turning it over to the Colorado Power Company, as well. In 1918 or 1919, Colorado Power dissolved Gem Electric. Renshaw left Boston-Colorado Power in 1915, relinquishing his lease on the American Sisters plant. No one filled the void, and the plant went bankrupt. Renshaw and Kansas investor C.L. Brown bought the facility at foreclosure auction under the Clear Creek Power Company, sustaining it into the 1920s. The owners of the two large companies sold none too quickly, because the early 1920s saw the mining industry completely collapse. Demand in the county reached an all-time low and offered room for only two providers, Colorado Power Company and Clear Creek Power Company.³⁸⁸

³⁸⁶ Acquisitions and Divestitures, 1966; Colorado Power Company, 1920:8; Dates of Original Construction, 1938.

³⁸⁷ Gambrill, Kenneth. *The Shoshone Hydroelectric Plant Complex, Glenwood Canyon, Colorado*. Denver, CO: Colorado Department of Highways, 1983, 7; Stone, Wilbur Fisk. *History of Colorado, Vol. 1-4*. Chicago, IL: S.J. Clarke Publishing Co., 1918, 318; Acquisitions and Divestitures, 1966; "Current News" *Mining Science* (10/5/11): 331; *Georgetown Courier* (11/19/10): p5 c4; Gidlund, 1925; History of the Company, 1935.

³⁸⁸ McCrary, Irvin J. *Development of Electric Power Industry in Colorado, 1916-1936*. Denver, CO: Colorado State Planning Commission, 1938, 24; Acquisitions and Divestitures, 1966; *Georgetown Courier* (7/24/15): p1 c2; *Georgetown Courier* (7/1/16): p1 c3; Gidlund, 1925; History of the Company, 1935; Stone, 1918, V.I:324; United Hydro Electric Company.

Public Service Company and the Last Major Changes, 1921-1964

During the 1920s, most of the Clear Creek County grid remained under one operator and saw few changes. Only five electrical facilities remained in service, including the Colorado Power Company substation at Idaho Springs, the Seaton Mountain facility below Idaho Springs, the hydro-plant built at Georgetown in 1900, the American Sisters plant north of Georgetown, and a plant at Fall River. The latter was independent, not tied to the main grid, and too small to rouse much interest. The Idaho Springs substation continued to be a collection point because the county's generating capacity exceeded consumption, with surplus electricity diverted into the main grid at the substation. The Clear Creek facilities were absorbed by Colorado's largest power provider over the course of the decade. The Denver Gas & Electric Company and Western Light & Power Company merged in 1923, forming Public Service Company to increase generating capacity and achieve economies of scale. The following year, Colorado Power Company joined under the Public Service Company name, drawing in subsidiary United Hydro. This left the Fall River facility and C.L. Brown's American Sisters plant, also known as the Pirie, as the only independent facilities in the county. Public Service purchased them in 1927.³⁸⁹

During the Great Depression, the local power grid continued its role as underwriter of the local economy, directly supporting an important mining revival. In 1934, President Franklin Roosevelt signed into law the Gold Reserve and Silver Purchase acts, stimulating mining throughout Colorado. Clear Creek County, and in particular the gold mines around Idaho Springs, participated, relying primarily on electricity for operations. In 1933, on the eve of Roosevelt's legislation, the American Sisters plant was struck by lightning and burned. During the remainder of the depression and through World War II, Clear Creek County mines consumed all the power that the remaining Georgetown plant generated.³⁹⁰

Mining collapsed again following World War II, local demand for electricity fell, and the Georgetown plant reverted to providing surplus energy to Public Service. The system remained unchanged until 1964, when Public Service built the Cabin Creek pump storage facility above Georgetown. The plant was not a net energy contributor and instead merely manipulated Public Service's customer rate structure. During off-peak hours when rates were lowest, the plant consumed electricity and pumped water from a reservoir below the plant up to another storage pond above. During peak hours, the system reversed, with water flowing from the upper reservoir, through the plant, and into in the lower pond. In so doing, the facility consumed power for pumping when rates were low and returned it to Public Service when rates were at their maximum. The Cabin Creek plant was the last major addition to Clear Creek County's system, although Public Service continued improving its grid. During the 1960s, Public Service replaced aging equipment and facilities with modern versions.³⁹¹

³⁸⁹ "Brief History of Public Service Company of Colorado." Manuscript WH 1367, Box 1, Folder FF7, Denver Public Library. 1931; Gambrill, 1983:7; *Georgetown Courier* (9/3/27): p1 c3; Gidlund, 1925.

³⁹⁰ *Georgetown Courier* (8/12/33): p1 c4.

³⁹¹ Robertson, 1982:18.

ELECTRIC POWER IN SUMMIT COUNTY, 1898-1936

Electric power generation in northern Summit County spanned 1898 through 1936 in the theme's overall Period of Significance (Tables 4.3 and 4.4, and Illustrations A 4.5 and A 4.6). An 1898 mining boom around Dillon and Frisco brought capital, expert engineers, and an increase in population. The principal mining companies understood electricity could lower operating costs and improve efficiency, while town residents wanted energy for lighting and modernity. Neither interest, however, had the money to fund a power plant capable of centralized service. The Excelsior Mine owners devised a plan in 1898 to make a power plant economically feasible. They built a plant primarily for in-house use, but offset the cost by selling service to Frisco and nearby mines. The strategy was a success, and the plant was the foundation for a small grid local to Frisco. Within a few years, five more companies built as many power plants, and two followed the Excelsior model, providing electricity to the communities of Dillon and Curtin.

In 1907, utility investors established the Summit County Power Company and bought the power plant at Dillon to fulfill a twofold plan. One was to expand service throughout the county, which had no centralized service and only small grids at Frisco, Dillon, and Breckenridge. The second was to sell surplus electricity to the Central Colorado Power Company once the large provider completed its main transmission line through the county. Summit County Power tied into Central Colorado's line in 1909 and began selling surplus electricity as planned. This relationship allowed Summit County Power to survive when the mining industry collapsed during the late 1910s. The rest of the power plants in the area closed, leaving Curtin and most of Frisco without service.

Table A 4.3: Ten Mile Power Grid Chronology

Year	Company	Powerplant
1898	Frank Wyborg reopens the Excelsior Mine at Frisco and installs a powerplant.	The <i>Excelsior powerplant</i> was installed near the Excelsior Mill as Frisco's first provider.
1901	The <i>Oro Grande Mining Co.</i> builds a hydropower plant north of Dillon.	The company builds the <i>AC Dillon hydropower plant</i> t mostly for its own needs and secondarily Dillon. The plant was seed for a local grid.
1906	The <i>Central Colorado Power Co.</i> was established and began building its Shoshone Plant near Glenwood Springs.	No service to Summit County until 1909.
1907	The <i>Summit County Power Co.</i> organized to provide power to Blue River and Frisco.	The company buys the <i>Oro Grande Dillon plant</i> .
1909	The <i>Summit County Power Co.</i> expands.	The company moves the <i>Oro Grande Dillon plant</i> one mile north of Dillon.
	The <i>Excelsior Mining, Milling & Electric Co.</i> expands service.	The company enlarges its private plant, serving to Frisco and surrounding mines.
	The <i>Central Colorado Power Co.</i> begins providing service to Ten Mile Canyon and Blue River.	The company finishes its Shoshone Plant and builds the <i>Dillon Substation</i> to distribute power. The system was linked with the Dillon plant.
1913	The <i>Colorado Power Co.</i> buys the bankrupt <i>Central Colorado Power Co.</i>	Service continued uninterrupted.
Early 1920s	The <i>Excelsior Mining, Milling & Electric Co.</i> suspends service and closes the Excelsior Mine.	The <i>Excelsior plant</i> ceases service. Frisco contracts with the Colorado Power Co. and Summit County Power for service.
1924	<i>Public Service Co.</i> merges with <i>Colorado Power Co.</i> to increase capacity and diversify power sources.	Service and relationship with Summit County Power remained unchanged.
1928	<i>Public Service Co.</i> bought <i>Summit County Power Co.</i>	Public Service Co. retires the <i>Dillon plant</i> , replacing it with the <i>Summit plant</i> .
1936	<i>Public Service Co.</i> reduces service.	The company closes the <i>Summit plant</i> and provides power from the <i>Dillon Substation</i> alone. The substation distributes power generated at Shoshone.

Table A 4.4: Ten Mile Independent Powerplants

Power plant	Builder	Equipment	Built	Retired	Operators
IXL Mine		DC hydropower	1899	1900s	
Admiral Tunnel Plant (served mine and Wheeler).	<i>Admiral Mining Co.</i>	DC hydropower	1902	1910	1902-1900s: <i>Admiral Mining Co.</i>
King Solomon Mine (served mine)	James H. Myers	Unknown	1904	1910s	1904-1912: James H. Myers 1914-1922: various lessees
Curtin Plant (served Curtin, Mary Verna and North American Mines)	<i>Southwestern Brokerage Co.</i>	AC hydro, steam	1905	1910s	1905: <i>Southwestern Brokerage Co.</i> 1906-1912: <i>Mary Verna Mining Co.</i> 1912-1910s: various lessees

Summit County Power remained the county's only provider through the 1920s. Public Service bought Summit County Power in 1928, replacing the Dillon powerhouse with the new Summit plant, and established a monopoly over the county. Public Service dismantled the Summit plant in 1936, ending the significant period of electrical generation in Summit County. Principal towns enjoyed power afterward, but supplied by Public Service's larger grid.

Beginning of the Ten Mile and Dillon Electric Grid, 1898-1906

Centralized power plants were costly and economically feasible only under certain conditions. First, the demand for electricity had to be high. During the 1880s and 1890s, lighting comprised most demand as industrial application was limited because technological problems retarded the transition from steam engines to electric motors. Second, the service area had to possess customers willing to pay a subscription fee. In the mountains, these two conditions existed primarily in substantial municipalities with large populations and sound economies. As discussed above, Clear Creek County was an excellent model for service by centralized plants. In contrast, Ten Mile Canyon and Dillon lacked the fortuitous conditions. The area featured a relatively small population, slow economy, and a silver mining industry suffering from slipping metals prices following the Silver Crash of 1893. Thus, the region inspired little confidence among potential investors in centralized service.

During the late 1890s, conditions began changing, giving rise to a local power industry. The national economy recovered, improvements in milling methods rendered complex and low-grade ore profitable, and investors reopened idle mines, equipping them with advanced technology. Ten Mile Canyon saw a major mining revival. James H. Myers and other investors perceived the potential offered by poorly developed mines, funding major development at the Etta, Excelsior, King Solomon, Mary Verna, and North American. The managers, many trained engineers, understood that electricity had great potential to lower operating costs and improve working conditions. Because the area lacked electrical service, however, the mining companies would have to generate their own. A power plant, no matter how small, was too costly for in-house use alone, so nearly all the companies relegated themselves to steam equipment and kerosene lamps.

Engineer A.B. Ogden, managing the Excelsior Mine, devised a clever solution. Frank B. Wyborg, New York investor, purchased the Excelsior, hiring Ogden in 1898 to build a mill and bring the mine into production. Ogden recommended electrification, and to offset cost, secured a contract with Frisco to provide the town with surplus power for lighting. The deal benefitted both parties, who received power that neither could otherwise afford. The owners of both the Recen and IXL mines near Frisco hoped to secure a similar arrangement, financing their own DC hydropower plant. Either through cooperative arrangement or independently, the investors came up with the capital necessary for a tiny power plant near the Recen Mine, providing power to nearby operations. On the Blue River, Dillon and the Oro Grande Mining Company came to similar agreement. Oro Grande ran a massive hydraulic placer mine west of Dillon, requiring power both for lighting and large pumps. In 1899, manager and president George E. West commissioned a hydropower plant immediately north of town, securing a contract to provide surplus power. The plant, a small DC facility, became the seed of Dillon's localized grid.³⁹²

Over the next five years, three more mining companies in Ten Mile Canyon built their own power plants in the absence of centralized service. The owners of the Admiral Tunnel near Wheeler built a hydro-facility in 1902, luring away the Excelsior electrician to oversee its operation. Frisco investor James H. Myers fronted the capital for the other two facilities. One was a generator installed at the King Solomon Tunnel in 1904. The other, second in importance only to the Excelsior plant, went up at the settlement of Curtin under supervision of engineer

³⁹² *Summit County Journal* (12/3/98): 1; *Summit County Journal* (12/10/98): 1; *Summit County Journal* (1/21/99): 1; *Summit County Journal* (4/15/99): 1; *Summit County Journal* (8/19/99): p4 p1; *Summit County Journal* (10/14/99) 1.

D.H. Lawrence. The plant, a DC hydro-facility with steam backup, provided lighting at Curtin and ran machinery at the Mary Verna and North American mines (see Illustration A 4.7).³⁹³

By 1906, Ten Mile Canyon and Dillon hosted six independent power plants built by mining companies largely for in-house use. Frisco, Dillon, and Curtin featured primitive electrical systems energized on a subscription basis by three companies, with none of the systems integrated. While six plants at as many mines and lighting in three settlements was a major achievement, such arrangements presented problems in terms of long-term service. The towns were secondary in priority and found service unreliable at times due to brownouts, freezes of hydro water lines, and temporary suspension for maintenance. Moreover, the communities could expect power plants to operate only as long as the mining companies were solvent. Thus, residents sought opportunity for centralized service.

Centralized Electrical Service, 1907-1920

Frisco, Dillon, and Curtin enjoyed electricity only a short time before problems forecast by leading community figures came to the fore. In 1907, a severe recession impacted mining and forced many operations to suspend. The Excelsior and Mary Verna continued ore production, but the Oro Grande Mining Company sold to another organization. While Frisco's service was unaffected, local business interests sought stability by organizing the Frisco Light & Power Company to ensure independent operation of the Excelsior plant. Curtin also saw no changes, although its stability was less certain because the settlement was strictly a function of James H. Myers's adjacent mines. Dillon faced the greatest threat, with service interrupted when the Oro Grande company ceased work.

When the Oro Grande company offered its assets for sale, a consortium of Denver utility investors saw the power plant as a foundation for a scheme larger than service to Dillon alone. In 1907, F.W. Frueauff, W.J. Parker, C.A.F. Porrine, and C.W. Stearne organized Summit County Power Company, bought the plant, and prepared for a multifaceted venture. All the investors had backgrounds in large utilities. Parker was manager of Denver Gas & Electric Company and president of Northern Colorado Power Company. Frueauff acted as vice-president of Denver Gas & Electric. Stearne served as vice-president of Arapahoe Light & Power Company.³⁹⁴

At first, it appeared that the investors planned on wiring much of Summit County for power. Until 1907, most of the county lacked electricity, and, apart from Dillon and Frisco, Breckenridge was the only other town with service. During the year, Summit County Power moved the Oro Grande plant to a new site one mile north of Dillon, increased its capacity, and converted the current to AC. Confirmation that Central Colorado Power Company was building its massive Shoshone facility and a major line to Denver revealed a larger purpose for the Dillon plant. In particular, Summit County Power planned on linking with the Shoshone system and selling surplus power to Central Colorado. Ultimately, the Parker group also hoped to sell Summit County Power in entirety to Central Colorado at a high price once the local system proved successful. No one in the county objected because they would gain an extensive and reliable grid.³⁹⁵

While the Parker group did not sell their company to Central Colorado, they realized the rest of their plan over the course of several years. During 1908, Summit County Power strung distribution lines to most of the mining districts, including Breckenridge, and connected with

³⁹³ *Breckenridge Bulletin* (12/3/04): 1; *Breckenridge Bulletin* (10/28/05): 1; *Summit County Journal* (11/15/02): 1.

³⁹⁴ *Breckenridge Bulletin* (10/5/07): 1; *Summit County Journal* (8/1/08): 1.

³⁹⁵ Baker, 1927, V.2:727; *Breckenridge Bulletin* (10/5/07): 1; *Breckenridge Bulletin* (6/29/07): 1.

Frisco Light & Power. In 1909, the company tied into Central Colorado's transmission line and began selling the surplus electricity as forecasted. Summit County Power built a large concrete substation at Dillon, which was now an important node on a grid that extended from Glenwood Springs to Denver and served nearly all the mining communities in between. The grid was Colorado's largest at the time, and the Dillon substation became the distribution hub for the Summit County region. Summit County Power proved to be profitable, serving the region through the 1910s. The only major change was the financial overextension of Central Colorado, its bankruptcy in 1913, and immediate sale to Colorado Power Company. Service in Summit County and the relationship with Summit County Power were unaffected. Demand for electricity was sound because the mining industry was relatively stable, maintaining a population in the region. Large companies replaced aging steam equipment with motorized apparatuses. The demand for electricity grew somewhat during the World War I revival of 1915 to 1918. In response, owners of the Excelsior Mine reorganized as the Excelsior Mining, Milling & Electric Company to take over Frisco service. All electricity generated by Summit County Power went to customers with no surplus remainder.³⁹⁶

In 1920, conditions changed abruptly. The nation entered a depression and metals prices collapsed, ruining the mining industry in Summit County. Demand for power decreased commensurately, impacting Summit County Power and the Frisco interests differently. Nearly all Frisco mines closed, including the Excelsior, and the region went dark. The Frisco system was still linked to Summit County Power and the town could have switched service, but most of the population left and revenue was insufficient to justify maintenance of the system. Summit County Power, on the other hand, remained solvent and continued providing power to Dillon, Breckenridge, and small hamlets in between. The arrangement that the company had with the Colorado Power Company was the key factor, so Summit County Power returned to being a net contributor to the Colorado Power Company grid.

Public Service Company and Last Major Changes, 1921-1936

In the decade following the 1920 collapse of mining, Summit County Power Company continued operating the Dillon system and made few major changes. Its generating capacity far exceeded regional consumption, with the surplus diverted into the main grid at the Dillon substation. While Summit County Power's relationship with the region remained the same, however, the company's ties to the greater grid shifted. In 1923, Denver Gas & Electric Company and Western Light & Power Company merged to form Public Service Company, increasing generating capacity. The following year, Colorado Power Company joined this consolidation under the Public Service Company name. Summit County Power now sold its power to Public Service, which began purchasing independent generators tied to its grid. In 1928, Public Service acquired and dissolved Summit County Power, closed the Dillon plant, dismantled the machinery, and incorporated it into the larger Summit facility built nearby. Because little local demand existed, Public Service planned the plant as a contributor to its overall system.³⁹⁷

During the Great Depression, the local power grid resumed a critical role as underwriter of the local economy, specifically the mining industry. In 1934, the Gold Reserve and Silver Purchase acts increased the values of both metals, stimulating a mining revival in which Summit County, in particular gold mines around Breckenridge, participated. The Summit plant powered

³⁹⁶ Colorado Mine Inspectors' Reports, Summit County: Excelsior; Colorado Power Company, 1920:7; Dates of Original Construction, 1938; *Summit County Journal* (8/14/09): 1.

³⁹⁷ Brief History of Public Service, 1931; McCrary, 1938:28.

the revival until 1936, when Public Service determined the facility not cost-effective, retiring it. Although this ended Dillon's local power industry, the Dillon substation continued serving Summit County, distributing power Public Service generated elsewhere.³⁹⁸

SHOSHONE PLANT AND COLORADO RIVER VALLEY, 1906-1962

The Period of Significance for, electrical generation in the Eagle and Colorado river valley spans 1906 through 1962. In 1906, investors organized the Central Colorado Power Company to build a massive electrical grid linking Glenwood Springs, Denver, and disparate electrical systems among mining districts in between. The company finished the Shoshone plant on the Colorado River in 1909, beginning service to Leadville and Summit County. During the next year, the company tied its system into those of other large providers in Denver and Boulder, creating Colorado's most extensive contemporary grid. The Central Colorado Power Company went bankrupt in 1913 and reorganized as the Colorado Power Company without interruption of service. The Shoshone plant continued to operate, fostering growth and supporting industry throughout the central mountains and Front Range. In 1924, Colorado Power merged the Shoshone system and other assets with the Public Service Company, thus becoming the principal energy provider in the northeast quarter of Colorado. Although the Shoshone plant is still in use by Xcel Energy, the Period of Significance ends in 1962, fifty years before this report was produced. Table 4.5 summarizes highlights, and Illustration A 4.8 illustrates geography.

Central Colorado Power's Shoshone Plant, 1906-1909

In terms of Colorado's electric power history, the Shoshone plant was a relatively late development. It was, however, one of the largest energy undertakings of its time in the state, and is still an important generation facility. The history of the plant began during the 1890s with visionary engineers Henry Hine and Leonard E. Curtis. Even though electrical technology was in a developmental state, they sought to imitate massive generation projects in the heavily industrialized East and began studying how to harness the Colorado River for hydropower. Hine and Curtis were well aware that they faced major challenges in both financing and physical conditions, and the partners knew that planning alone would take years.

Table A 4.5: Eagle River Valley Power Grid Chronology

Year	Company	Powerplant
1886	The town of Glenwood Springs builds a hydropower plant.	The <i>Glenwood Springs plant</i> serves the town and its resorts only.
1890s	Leonard E. Curtis and Henry Hine began studies of harnessing the Colorado River for power.	No plants built.
1903	The <i>Colorado Power & Irrigation Co.</i> , <i>Grand River Power & Transportation Co.</i> , and <i>New Century Light & Power Co.</i> organized to develop hydropower plants at Shoshone Falls.	The companies built no plants but obtained water rights and plant sites, possibly for speculation.
1906	Curtis and Hine organize the <i>Central Colorado Power Co.</i> and absorb the <i>Grand River Power</i> and <i>New Century Light</i> companies for water rights and plant sites.	The company builds a <i>temporary hydropower plant</i> at Shoshone Falls and began building a main plant nearby. The company also establishes the temporary workers' camp of Shoshone.

³⁹⁸ McCrary, 1938:28.

Year	Company	Powerplant
1909	The <i>Central Colorado Power Co.</i> begins service.	The company finishes its <i>Shoshone Plant</i> and builds a transmission line through Red Cliff and Leadville to Dillon. The company provides service throughout Lake and Summit counties.
1910	The <i>Central Colorado Power Co.</i> begins service to Clear Creek County and Denver.	The company completes its transmission line from Dillon to Denver in 1910 and builds the <i>Idaho Springs Substation</i> to distribute power in Clear Creek County. The company ties into existing systems in Denver and Boulder.
1913	The <i>Colorado Power Co.</i> buys the bankrupt <i>Central Colorado Power Co.</i>	Service continues uninterrupted.
1916	The <i>Colorado Power Co.</i> buys the <i>United Hydro Electric Co.</i>	<i>United Hydro Electric</i> provides power throughout Clear Creek County uninterrupted.
1917	The <i>Colorado Power Co.</i> purchases and absorbs the <i>Gem Electric Co.</i> which provides power to the Idaho Springs area.	The <i>Colorado Power Co.</i> closes the <i>Gem Electric Co.</i> plant.
1923	<i>Western Light & Power Co.</i> and <i>Denver Gas & Electric Co.</i> merge to form <i>Public Service Co.</i>	<i>Public Service</i> serves the Denver area and northeast Colorado.
1923	The <i>Eagle River Electric Co.</i> begins providing service to Eagle, Gypsum, and Eckley.	
1924	<i>Public Service Co.</i> merges with <i>Colorado Power Co.</i> to increase capacity and diversify power sources.	The companies consolidate systems.
	<i>Public Service Co.</i> absorbs <i>United Hydro Electric Co.</i>	<i>Public Service Co.</i> continues its Georgetown plants, with service in Clear Creek County unchanged.
1928	<i>Public Service Co.</i> buys <i>Summit County Power Co.</i>	<i>Public Service Co.</i> retires the <i>Dillon plant</i> , replacing it with the <i>Summit plant</i> .
1936	<i>Public Service Co.</i> reduced service to Summit County.	The company closes the <i>Summit plant</i> and provides power from the <i>Dillon Substation</i> alone. The substation distributes power generated at Shoshone.
1940s-1950s	<i>Public Service Co.</i> serves Pitkin, Eagle, Lake, Summit, Clear Creek, Gilpin counties.	<i>Public Service Co.</i> operates the Shoshone, Georgetown, Boulder, and Denver plants.
1964	<i>Public Service Co.</i> builds the <i>Cabin Creek hydropower plant</i> at Georgetown.	

Hine and Curtis were not the only electrical experts considering diverting the Colorado River for power. Three groups of investors made their intentions known by organizing companies in 1903. Leadville mining investor Albert Sherwin, Glenwood Springs businessman E.E. Lucas, and others established Colorado Power & Irrigation Company to develop a hydro-plant at Shoshone Falls east of Glenwood Springs. A series of three reservoirs on tributary drainages would ensure water supply, while a transmission line would carry power primarily to Leadville, which had a limited electrical system at the time. Sherwin had direct interest in the project because his mines would benefit, while Lucas brought experience from the Glenwood Springs power plant, built in 1886. The other entities were Grand River Power & Transportation Company and New Century Light & Power Company.³⁹⁹

Sherwin and Lucas' firm was legitimately interested in building a power plant, while the latter two companies were speculative, seeking water rights and plant sites for resale. All, however, lacked the expertise of Hine and Curtis, who concluded that a massive power plant was

³⁹⁹ "Colorado Power Company Formed." *Summit County Journal* (6/23/03): 7; Gidlund, 1925.

feasible and designed a practical system. Ready to build, Hine and Curtis interested investors in both the east and Colorado, organizing Central Colorado Power Company at the end of 1906. These investors included George R. Bucknam, J.A. Hayes, Myron T. Herrick, Horace G. Lunt, David Moffat, George B. Tripp, and Orlando B. Wilcox among others. Moffat represented a wealthy Colorado investment syndicate, with mines in Summit and Lake counties that would benefit from inexpensive power. Herrick, an eastern investor, had direct experience with electrical projects and ready access to funds.⁴⁰⁰

Money was crucial, because Hine and Curtis' project would be very costly, involving a chain of power plants and dams. The plan would install a small, pilot generator at Shoshone Falls to provide power for building the larger, and yet still temporary, Shoshone plant a short distance downstream. The Shoshone plant in turn would provide limited service to mining districts while Central Colorado completed two permanent plants at Glenwood Springs and Gore Canyon. A dam would divert the Colorado River into a twelve-mile tunnel providing some water to Shoshone and the rest to a reservoir on Grizzly Creek for the Glenwood Springs plant. Williams Fork and two other tributaries were to be dammed to ensure the Gore Canyon plant adequate water for continuous operation. The company planned high-voltage transmission lines to Denver, connecting with providers and following a circuitous route through the principal mining districts to maximize customer base. Further, the company knew it could unify the grids in Leadville, Summit County, and Clear Creek County, siphoning surplus electricity when available. The proposed hydraulic engineering was challenging, requiring a dam across one of the largest rivers in the Rocky Mountains, boring one of the longest tunnels in Colorado, and creating a high-volume water system in rugged conditions. The electrical engineering sought coordination not only the company's three plants on the river, but also with primitive grids in the project area. Each grid had its own voltage, amperage, type of current, and equipment. Transformers and other appliances had to interface with Central Colorado's transmission line, requiring application of complex electrical theory.⁴⁰¹

At the end of 1906, Hine, Curtis, and investors moved to bring the plan into fruition. Central Colorado absorbed the Grand River and New Century companies for their sites and water rights, also filing a petition to assume rights for all the Colorado River flowing into Shoshone Falls for generation and irrigation. Sherwin and Leadville associates established Leadville Light & Power Company to consolidate that town's grid, including Leadville Gas & Electric Company and its DC hydro-facility with the steam AC plant at the Yak Tunnel. When the Colorado River slowed during the fall, Central Colorado dispatched workers to build the preparatory infrastructure for the Shoshone plant. In particular, they completed the pilot hydro-plant at the falls and erected the company camp of Shoshone near the main plant site.⁴⁰²

Central Colorado spared little expense providing for its workers. The camp of Shoshone had apartments for families, boardinghouses for single men, individual houses for managers and superintendents, a dining hall, commissary, school, doctor, and post office. Some buildings and a freight terminal lay on the Denver & Rio Grande Railroad on the south side of the river, with a bridge and cable tramway crossing to the main portion on the north side (see Illustration A 4.9). Taylor State Road, graded from Glenwood Springs in 1899, provided a link with the outside world, but the railroad had to deliver nearly all supplies because the road was rough.⁴⁰³

⁴⁰⁰ History of the Company, 1935; Stone, 1918, V.I:317; *Summit County Journal* (11/16/06): 2.

⁴⁰¹ "Comprehensive Plans of the Central Colorado Power Company." *Eagle Valley Enterprise* (9/27/07): 1; Gambrill, 1983:13; History of the Company, 1935; Stone, 1918, V.I:317.

⁴⁰² Gambrill, 1983:3, 6; Gidlund, 1925.

⁴⁰³ Bauer, William H., Ozment, James L., Willard, John H. *Colorado Post Offices: 1859-1989*. Golden, CO: The Colorado Railroad Museum, 1990, 131; Gambrill, 1983:6.

During the winter of 1907, while the river was still low, workers began building the diversion dam above the falls (see Illustrations A 4.10 and A 4.11). The company hired miners to bore the tunnel while other workers constructed the earthwork for the plant and water system. The tunnel was to be two miles long, start at the falls, end above the Shoshone plant site, and parallel the north side of the canyon. To expedite progress, eight access adits were bored into the canyon wall. From within these, teams of miners turned ninety degrees and simultaneously bored toward each other. The various segments would be linked to form the two-mile tunnel. Activity on the system was not restricted to the canyon. During 1907, workers successfully hung the transmission line from the pilot power plant through Red Cliff to Leadville and as far as Summit County. The transmission towers were steel with wire of copper strands woven around a hemp center for tensile strength. Much power that the pilot plant generated was consumed by Central Colorado, with the rest sent to Leadville.⁴⁰⁴

In the thick of construction, Central Colorado suffered a blow forcing the investors to rethink the master plan. The nation fell into a sharp recession in 1907, pushing the Knickerbocker Trust Company of New York, which meted out loan funds to Central Colorado, to the brink of collapse. Knickerbocker Trust temporarily suspended payments and Central Colorado ran out of money as a result, halting the entire project and laying off 600 employees. Knickerbocker extracted itself from financial ruin and resumed loan payments in 1908, but its investors reduced the amount of capital available to Central Colorado. Thus, Hine, Curtis, and associates had to reduce the scope of their master plan. The company abandoned the massive Glenwood Springs and Gore Canyon plants, reservoirs, and twelve-mile tunnel, leaving what was supposed to be the temporary Shoshone plant as the principal project.⁴⁰⁵

In 1909, with everything but the transmission line to Denver finished, Central Colorado prepared for service. During May, Superintendent Eldridge opened the headgate of the water tunnel, admitting a flow of 125 cubic-feet-per-second to test the machinery. In a ceremony one month later, Lieutenant Governor Fitzgerald opened the tunnel gates to their full flow of 1,250 cubic-feet-per-second, formally beginning service. At a cost of \$10,005,000, the power plant generated 10,000 kilowatts of AC current transmitted in 100,000 volts, or equivalent to 20,000 horsepower. By comparison, the motors used in the mining industry were typically 25 to 75 horsepower, with each mine or mill usually employing only one or two. The tunnel was 12' x 17' in-the-clear, funneling water into two penstocks 9' in diameter with a fall of 165'. At the bottom, two turbines within a steel frame, corrugated-sided building generated the electricity. The voltage was unusual and second highest in the nation, exceeded only by a power plant in Michigan. This voltage ensured transmission the 150 miles to Denver, but complicated unification of the Central Colorado system with those in Lake, Summit, and Clear Creek counties, as predicted. Central Colorado also laid claim to another record, the altitude of the line. The wires crossed several passes, including Argentine, where physical conditions presented problems no engineers in the greater power industry had yet faced. Hurricane-force winds regularly parted the power lines. To study what was happening, Central Colorado engineers installed wind velocity gauges, which were swept away and destroyed after registering winds of 165 miles per hour. In response, the company deviated from the convention of using copper wires, replacing them with hardened steel. Ultimately, Central Colorado successfully completed the most extensive contemporary power system in Colorado, if not the Rocky Mountains.⁴⁰⁶

⁴⁰⁴ Robertson, Lawrence M. *The Birth and Growth of Electricity in Colorado*. 1982, 11; Brief History of Public Service, 1931; Gambrell, 1983:3.

⁴⁰⁵ History of the Company, 1935; *Summit County Journal* (12/28/07): 1.

⁴⁰⁶ "Hot, High and Powerful Voltage." *Summit County Journal* (7/24/09): 1; "Shoshone Plant in Operation." *Eagle Valley Enterprise* (5/21/09): 1; "Shoshone Plant Turns on Water." *Eagle Valley Enterprise* (6/11/09): 4; Brief History of Public Service, 1931; Gambrell, 1983:5; Gidlund, 1925; Robertson, 1982:13.

The Shoshone Plant Changes Ownership, 1910-1924

After Central Colorado Power Company operated the Shoshone plant for a year, the system was clearly a technological success. The company made a few adjustments to the infrastructure, but did not change the powerhouse or circuitry. With construction finished, the company disassembled the Shoshone camp and cancelled its post office. The pilot plant at the falls was dismantled, but the company left several residences and a garage there for a permanent crew of dam workers. At the plant site, the company maintained a boardinghouse, manager's residence, and machine shop to service equipment.

While the system functioned as engineered, company principals could not make similar claims about the finances. The company's financial structure was predicated on a steady increase in demand, mostly from the mining industry, which failed to materialize. Shortly after 1900, when Hine and Curtis developed the plan, Colorado was at the peak of a statewide mining boom. Company principals assumed that heavy production would continue and even increase when inexpensive electricity became available. Instead, mining gradually declined. The Central Colorado company wisely secured an agreement with Denver Gas & Electric Company to buy surplus power wired to Denver, but this did not offset missed revenue. In 1910, for example, the Shoshone plant generated only around half its capacity. As a result, Central Colorado company began missing interest payments on its loans, eventually going bankrupt in 1913.⁴⁰⁷

When it was rumored that Central Colorado was to be sold, the General Electric Company immediately organized the Colorado Power Company, buying both the Shoshone system and Northern Colorado Power Company, which operated Barker Dam and a hydropower plant at Boulder. Investors considered these a foundation for assembling a larger electrical empire in Colorado. The timing was fortuitous. Within several years, heavy demand for silver and industrial metals due to World War I stimulated a mining revival in the Shoshone plant's service area, while growth around Boulder and surrounding communities drew power from that facility. With sound financing, Colorado Power Company began an expansion campaign. In 1916, the company purchased United Hydro Electric Company as a subsidiary, which dominated Clear Creek County and fed the Shoshone system with extra power. Around the same time, Colorado Power also took over small systems at Salida, Alamosa, and Sterling. Along with these companies came notable Colorado investors, who gained high positions in Colorado Power.⁴⁰⁸

In 1920, mining collapsed with the national postwar depression. Although demand for electricity fell, Central Colorado remained in sound condition because of its diversified customer base. The company commanded the central portion of the state from Alamosa north to Dillon, from Glenwood Springs east through Clear Creek County, and the plains from Boulder to Loveland. Colorado Power directors were not the only capitalists interested in expanding service territory through consolidation. In 1923, Denver Gas & Electric Company and Western Light & Power Company merged to form the Public Service Company of Colorado to increase generating capacity and achieve economies of scale. Denver Gas & Electric dominated the Front Range communities, as Western Light did the agricultural region to the north. The directors of Colorado Power and Public Service concluded that a union of the two systems was sound economic policy, joining in 1924 under the Public Service name. The power giant now had a monopoly over all central, north-central, and northeastern Colorado.⁴⁰⁹

⁴⁰⁷ Gambrell, 1983:7; History of the Company, 1935.

⁴⁰⁸ Gidlund, 1925; History of the Company, 1935; Stone, 1918, V.I:318; United Hydro Electric Company.

⁴⁰⁹ "History of Predecessor Companies, 1910-1924." [Manuscript WH 1367, Box 1, Folder FF42](#), Denver Public Library. 1942; Brief History of Public Service, 1931; Gidlund, 1925; Robertson, 1982:9.

The Public Service Company and Its Unified Grid, 1925-1962

When Colorado Power Company and Public Service merged in 1924, they assumed control over nearly all of northeastern Colorado, the fastest growing market in the state. Incorporating the physical infrastructure of the different systems proved complex. Company experts coordinated voltage, amperage, current types, demand, and generation sources to the best of their abilities. Within a short time, they wove a number of disparate small grids into what Public Service termed the Central System. In particular, the Shoshone line linked with the Denver system, and with the Boulder grid separately. The Boulder grid in turn was tied to Denver. From this triangle, transmission lines radiated outward while distribution lines carried current to points of consumption. Service would continue should a powerplant fail, as energy sources were relatively diversified.⁴¹⁰

In the I-70 corridor, three pockets of customers escaped immediate integration into the system. In Eagle County in 1923, local businessmen organized Eagle River Electric Company to provide power to Eagle, Gypsum, and Eckley. It remains unknown whether the provider built its own small plant or wholesaled electricity from the Shoshone circuit. The second pocket was Summit County, served by Summit County Power Company since 1907. The last were Empire and Lawson, which Clear Creek Power Company served from its American Sisters hydro-plant. Outside the corridor in Clear Creek County, a small independent plant also served the mining community of Fall River.

During the 1920s, Public Service made its last major effort to draw in independent power companies and establish a total monopoly. In 1924, Public Service absorbed United Hydro Power, and three years later, bought both the American Sisters plant at Georgetown and the Fall River facility. In 1926, Public Service looked farther east and west, purchasing companies in Ovid, Brush, Rifle, and Grand Junction. In 1928, the company finally acquired Summit County Power's Dillon plant, which had been independent but wholesaled most of its electricity to Public Service. It remains unknown whether Public Service connected the Grand Junction and Rifle plants to the Shoshone circuit, but by the late 1920s, the Central System generated around 82,000 kilowatts of electricity.⁴¹¹

While Public Service increased its territory, it made relatively few changes to the grid in the central portion of the state after the late 1920s. The company possessed a permanent infrastructure, water rights, and plant sites. Most changes were improvements such as increased generating capacity, replacement of aging infrastructure, introduction of efficient wiring and appliances, and retirement of inefficient plants. By 1964, the only generators left on the Central System were Shoshone, United Hydro and Cabin Creek facilities at Georgetown, and hydropower and Valmont steam plants at Boulder. These still produce most electricity consumed between Glenwood Spring and Denver, sharing a grid that, while modernized by 1970, has changed little overall since 1909.

⁴¹⁰ Gidlund, 1925.

⁴¹¹ Brief History of Public Service, 1931; Gidlund, 1925; History of the Company, 1935.

Section A 5: History of Railroad Transportation, 1873-1962

Introduction

Railroad transportation is an important historical theme throughout the I-70 Mountain Corridor. Associated resources can be found in all principal river drainages, where five different companies operated eight distinct railroad lines. Railroads played a fundamental role in corridor history, shaping patterns of growth, natural resource extraction, economic development, and culture. The railroads literally tied together people, places, industries, and institutions, linking them with the outside world. This section provides histories of the corridor's railroad lines, a topic complicated by industrial politics, economics, and the geography of greater railroad systems. Subsections in the text below focus on railroad lines in three principal drainages: Clear Creek, Blue River and Ten Mile Canyon in Summit County, and the Eagle and Colorado rivers in Eagle County. Overviews of the parent systems inform context for individual lines. Clayton Fraser's 1997 statewide railroad context, entitled *Railroads in Colorado, 1858-1949: Multiple Property Submission*, reviews the drainage's railroads.⁴¹² But coverage is a brief statewide overview rather than in detail suited for evaluating historic resources specific to the corridor.

Period of Significance, 1873-1962

Railroad transportation has been significant in the I-70 Mountain Corridor from 1873 to 1962. In 1873, the Colorado Central Railroad established the corridor's first railhead at the base of Floyd Hill in the eastern end of Clear Creek valley. The Period ends in 1962, fifty years before this report was produced. All the corridor's rail lines have been dismantled except for three still in existence. The Denver & Rio Grande Western route along the Colorado River, in the corridor's western portion, presently carries regional as well as transcontinental traffic. The Georgetown, Breckenridge & Leadville grade, between Georgetown and Silver Plume, is a heavily ridden tourist attraction as in the past. Although not in use at present, the Denver & Rio Grande Western track from Dotsero to Leadville is intact. All have been impacted within the last fifty years through replacement of materials, equipment, and structures. Eligibility might not, however, be precluded. The resources in entirety, or segments therein, could be eligible if present character-defining attributes sufficiently convey resource significance. The resources may qualify for nomination under a later Period of Significance as time passes and this context is updated. They can also be evaluated under NRHP Criterion Consideration G, recognizing exceptionally important properties that achieved significance within the last fifty years.

Each drainage features its own history of railroading. The lines were manifestations of local industry and settlement, politics among railroad giants, and topographical conditions. Railroad companies chose the drainages for their existing markets, growth potential, and natural resource wealth. Further, the drainages proved natural railroad routes, with gentle gradients for steam locomotives and broad floors for rail beds and their sweeping curves. Although the broad Period of Significance applies to the corridor as a whole, narrower timeframes are relevant for the individual drainages. The timeframes are based on when railroads operated locally, which was 1873-1940 in Clear Creek 1882-1937 in Blue River and Ten Mile; and 1886-1962 along the Eagle and Colorado rivers. Railroads and their associated historic resources generally embody the following NRHP Areas of Significance: Architecture, Commerce, Community Planning and

⁴¹² Fraser, Clayton *Railroads in Colorado, 1858-1949: Multiple Property Submission* Denver, CO, 1997, Colorado State Historic Preservation Office, Colorado Historical Society.

Development, Economics, Engineering, Industry, and Transportation. Level of significance is local, and could be statewide or national, depending on further research.

Overview of Railroad Systems

The I-70 corridor railroads fulfilled numerous functions important on local and statewide levels. In providing their service areas with inexpensive transportation and an all-season link with the outside world, the railroads revolutionized industry, economy, settlement, and quality of life. On a broader level, corridor railroad lines were also part of a statewide system with ties to a national network. These connections facilitated a flow of natural resources, goods, and people between a variety of places.

Each railroad consisted of physical components making it a functional system in itself. In overview, railroad grades were the lines themselves, featuring the tracks used by trains. Tunnels and drainage structures, including bridges and culverts, allowed the tracks to pass through or over topographic impediments common to mountain routes. Without these structures, the railroad lines would have been impossible. Right-of-way structures facilitated orderly, all-season operations necessary for the success of any mountain railroad. Fences and snowsheds kept the tracks clear for efficiency and safety. Coal bins and water tanks fed locomotives and kept them running between stations. Later, signs and signals controlled traffic on the tracks, also creating order in yards and at road crossings. Maintenance structures supported ongoing operations, equipment servicing, and freight handling. Depots were nodes of administration and business, serving as exchanges for people, freight, communications, and money.

The grade, a principal structure of any railroad route, is a distinct, large-scale, structure whose design was heavily influenced by the mechanics of locomotives and their trains of cars. In form, grades preferred straight lines, broad curves, with gradients rarely exceeding five percent to accommodate the limited traction power and turning radii of locomotives. Grades also featured smooth surfaces with gradual slope transitions to prevent trains from parting. Thus, extensive cuts, fills, and sweeping curves were necessary to maintain a consistent pitch (see Illustration B 5.1). Where a grade could not pass around a topographic obstruction such as a rock outcrop, it sometimes went under, through a tunnel. Bridges carried the grade over streams and rivers, while culverts directed minor drainage underneath the bed.

Most grades included the rail bed, a layer of ballast, the track, and associated aspects such as spurs, sidings, and switches. The bed, a foundation for the track and ballast, had to be surveyed and graded to exacting specifications. Afterward, workers paved the bed with a veneer of ballast to provide a smooth, well-drained surface. Once the ballast was ready, track gangs assembled the track. All the railroad companies in the I-70 corridor initially built their tracks to narrow-gauge specifications, in which the rails were spiked exactly 3' apart inside-width. The gauge was well suited for mountain conditions because it cost less to construct and negotiated tighter curves. By the late 1880s, the Denver & Rio Grande and possibly other carriers began converting to standard-gauge with rails spiked exactly 4' and 8½" apart inside-width. Standard-gauge was universal among non-mountain railroads.

While all railroad grades featured a main line, they often had minor tracks that controlled the flow of traffic and directed trains to service points. Sidings paralleled the main line and had entry and exit switches, and spurs were dead-end tracks. Named for their configuration, wyes extended away from a main line at oblique angles, sometimes joining it with other tracks or on dead-end spurs to turn locomotives around.

Keeping a railroad system and its equipment in running order was a perpetual and costly process because mountain conditions and climate caused heavy wear. Hardware, structural

elements, tools, machinery, and rolling stock required regular maintenance if not replacement. Railroad companies completed most of this work at centralized facilities located outside of the I-70 corridor. But they also had satellite yards at strategic points within, occasionally on spurs and sidings, but primarily in centers of operation such as Georgetown or Minturn (see Illustration B 5.3). The yards also were used for freight transfer and storage, and sometimes workers' housing. Service facilities included open work stations, structures, buildings, and mechanical systems usually clustered together along a rail siding or spur. A typical satellite yard may have included one or two shops for machining and carpentry, and an open-air work station where large pieces of equipment were serviced. Workers stored lubricants, solvents, and other goods in a small oil house, and tools and handcars for track maintenance in a tool shed. Locomotives received coal and traction sand from bins along a spur track or siding, where train crews also stationed snowplows and empty cars. Multi-use yards sometimes had loading docks, storage sheds, and hoisting derricks for freight.

Depots, covered in detail in Fraser's Colorado railroad context, are among the most celebrated icons of the mountain railroads. The depot was also a crown jewel for every mountain community served by a railroad because it symbolized reliable transportation, local economic success, and corporate presence, all strong values of the time. Depots were also focal points for movement of people and freight, and communication in the forms of newspapers, mail, telegraphs, and telephones. Railroad companies, as well, assigned great importance to depots for a number of reasons. Ticket and freight offices were principal places of business where revenues were collected. Administrative offices were centers of regional operations, coordination among trains, maintenance, and railroad communications. Some depots even offered housing for regional railroad employees. Fraser identified five general types of depots common in Colorado, including combination, flag, passenger, temporary, and terminal depots. All categories except for terminal depots existed in the I-70 corridor.

CLEAR CREEK DRAINAGE RAILROAD SYSTEM, 1873-1940

The Period of Significance for railroading in Clear Creek drainage spans 1873 through 1940. The Colorado Central Railroad established its Floyd Hill railhead in 1873, instituting the region's first all-season link with Denver, greatly reducing transportation costs and fundamentally altering local development. First, the railroad ushered in a mining boom. Companies imported better equipment, producing higher tonnages of lower grade ore. They also shipped ore by rail to effective smelters. Second, the railroad made a wider variety of goods and food available, improving quality of life. The conditions fostered a productive mining industry, quality workforce, and stable population with a higher proportion of families. When the Colorado Central Railroad graded up Clear Creek to Georgetown in 1877, it intensified these trends. The boom matured and spread mining's footprint deeper into the surrounding mountains. The railroad also supported logging through tie production and by linking sawmills with local consumers and Denver markets. Completion of the Georgetown, Breckenridge & Leadville Railroad to Graymont in 1884 improved access to Silver Plume mines and the county's westernmost forests. Silver Plume and the local timber industry reached peak production during the decade. Finally, the two railroads were a conduit for culture, refined goods, architectural style, and a tourist trade. Both railroads followed the floor of Clear Creek valley, but the Argentine Central Railroad, Clear Creek system's third addition, deviated from this pattern. In 1905, mining investors graded a line ascending from Silver Plume southeast up McClellan Mountain, continuing southerly to Waldorf in the Argentine Mining District. Each railroad was independent, but shared close relationships as members of a broader transportation system.

The Colorado Central, and especially the Georgetown, Breckenridge & Leadville, became instruments of railroad industry politics. To pay a huge debt for its transcontinental line and gain control over the Rocky Mountain region, Union Pacific Railroad waged a battle to secure the Colorado Central as a feeder. Union Pacific wanted to dominate service to Leadville and Summit County, both highly productive mining centers, for similar reasons. Union Pacific then built the Georgetown, Breckenridge & Leadville as a first segment in a larger system planned over the Continental Divide. Union Pacific abandoned the project, but the short-line became an important extension from Georgetown to Silver Plume. The Clear Creek drainage railroads declined with mining during the late 1910s. Although struggling themselves during the Great Depression, the railroads supported a mining revival and kept the cost of goods low. The revival created jobs and generated income in a time of need. The railroad ended service in 1940 when traffic was unable to pay operating costs. Table 5.1 summarizes Clear Creek drainage's three railroads.

Table 5.1: Clear Creek Drainage Railroad System Data

Colorado Central Railroad (CCRR)	
Year Organized	1868
Total System Construction Timeframe	1868-1881
Completion of Floyd Hill Railhead	1873
Completion of Georgetown Extension	1877
Operating Timeframe	1870-1940
Operation of Georgetown Extension	1877-1939 to Georgetown, 1940 to Idaho Springs
Predecessors	Colorado & Clear Creek Railroad Company, 1865-1866 Colorado Central & Pacific Railroad Company, 1866-1868
Headquarters: Location	Central City
Traffic/Service: Type	Common carrier emphasizing mining and tourism
Disposition	1890, consolidated into Union Pacific, Denver & Gulf RR 1898, included in reorganization as Colorado & Southern Railroad
Georgetown, Breckenridge & Leadville Railroad (GB&L)	
Year Organized	1881
Total Line Construction Timeframe	1881-1884
Operating Timeframe	1884-1939. Spur to Graymont, closed in 1890. 1975-Present, Colorado Historical Society rebuilt line.
Predecessors	None
Headquarters Location	Denver
Traffic/Service Type	Common carrier emphasizing mining and tourism
Disposition	1890, consolidated into Union Pacific, Denver & Gulf Railroad. 1898, included in reorganization as Colorado & Southern Railroad.
Argentine Central Railroad	
Year Organized	1905
Total Line Construction Timeframe	1905-1906
Operating Timeframe	1906-1917
Predecessors	Silver Plume & Gray's Peak Railway & Reduction Co., 1904
Headquarters Location	Denver
Traffic/Service Type	Common carrier emphasizing mining and tourism
Disposition	1909, sold to Gray's Peak Scenic Development Company. 1911, reorganized as Georgetown & Gray's Peak Railway Company. 1911, leased to Argentine & Gray's Peak Railway Company.

Colorado Central Railroad: Organized, 1865-1870

As early as the 1860s, Colorado entrepreneurs understood that their territory required a railroad, as demonstrated east of the Mississippi River where railroads facilitated growth of industry, agriculture, infrastructure, communications, and population. They lowered transportation costs, increased productivity, improved quality of life, and hastened the movement of people. This was especially true in Colorado during the 1860s, when the region languished with decline of the short-lived Pikes Peak gold rush. Entrepreneurs recognized that the region's stability and their own aspirations for economic growth were at stake. Although the business community was small, it was not in agreement over railroad construction logistics. One group, represented by John Evans, David Moffat, Bela M. Hughes, and Walter Cheesman, felt that Denver should be Colorado's hub of commerce, communications, and politics. Thus, they reasoned, it should also receive the first railroad. A rival group argued that Golden was better suited because it was gateway to mountain settlements, source of Colorado's wealth at the time. Gilpin County mining capitalists Henry M. Teller, Enos K. Baxter, and Jerome Chaffee supported William A.H. Loveland's push for Golden.

Both the Denver and Golden enthusiasts hoped that the Union Pacific Railroad (UPRR) would grade its transcontinental rail line, then under construction, across the plains and into Colorado. Each petitioned for exclusive service to their communities, even though UPRR was far from choosing a route through the territory at all. Colorado offered the only significant market between Kansas and Salt Lake City, but the Rocky Mountains formed a discouraging barrier. Instead, engineers considered Wyoming, where the Continental Divide was less daunting.

In this uncertain climate, Loveland convinced Golden capitalists to proactively build their own railroad and connect with UPRR, regardless of its final route. They still hoped, however, to draw UPRR to Colorado. In 1865, Loveland, Baxter, Teller, A. Gilbert, Milo Lee, John T. Lynch, Thomas Mason, and John A. Nye chartered the Colorado & Clear Creek Railroad Company. An ambitious master plan outlined a system to harvest both mining business in the mountains and agricultural trade on the plains. Loveland planned Golden as a hub with western lines up Clear Creek to Black Hawk, Central City, Idaho Springs, and Empire. Eastern lines would serve Denver, the plains, Boulder and nearby coal mines, connecting with UPRR. The company even talked of crossing Berthoud Pass to Middle Park and pushing on to Utah.⁴¹³

In 1866, UPRR decided not to cross the Divide in Colorado in favor of Wyoming's coal reserves and easier crossing. Loveland realized that if he wanted a railroad, he would have to build the connecting line to Wyoming. He sought assistance from UPRR, which considered Loveland's railroad a strategic feeder, but was unwilling to provide direct funding because of transcontinental charter restrictions. Loveland and partners thus reorganized their venture as the Colorado Central & Pacific Railroad to facilitate outside capital, which was not forthcoming.⁴¹⁴

Evans and his Denver associates became concerned that they were being bypassed. UPRR kept its distance from Denver with its Wyoming route, while Loveland's proposal recognized Denver only with a minor spur. The Union Pacific Eastern Division, separate from the transcontinental UPRR, planned a line west toward Colorado from Kansas, but avoided Denver and instead veered north to join the main UPRR in Wyoming. The Evans group needed

⁴¹³ Abbott, Carl, Leonard, Stephen, and McComb, David. *Colorado: A History of the Centennial State*. Niwot, CO: University Press of Colorado, 1994 [1982], 19; Hall, Frank *History of Colorado, V.I.* Chicago, IL: Blakely Printing Co., 1889, 410; Hauck, Cornelius W. *Narrow Gauge to Central and Silver Plume*. Golden, CO: Colorado Railroad Museum, 1979, 13; Jessen, Kenneth. *Railroads of Northern Colorado*. Boulder, CO: Pruett Publishing Company, 1982, 26.

⁴¹⁴ Hall, 1889:412, 424; Hauck, 1979:16; Jessen, 1982:26.

to take aggressive action to secure a position in the network, but realized that UPRR delays and Loveland's inability to secure financing granted them a window of time.

Moving quickly, Evans and associates organized the Denver Pacific Railroad in 1867 to grade north to UPRR at Cheyenne. The Denver interests ran into the same problems as Loveland: they had capital to establish the company but not enough to build and operate the railroad. Evans appealed to UPRR as Loveland had but met with similar results, an offer of rails and rolling stock in exchange for control and a trade agreement. Evans disagreed with the terms, ended negotiations, and sought help from the federal government instead, which was strongly interested in fostering a rail system in the West. The government offered Denver Pacific 900,000 acres of land if Evans would use his railroad as a link connecting Kansas Pacific in Kansas with UPRR at Cheyenne. The deal would provide links with not one, but two rail lines to the east. Evans sold some of the federal acreage, borrowing against the rest for needed cash.⁴¹⁵

Meanwhile, Loveland had been holding secret meetings with UPRR to secure their support. UPRR officials realized that, following rejection by the Denver Pacific, Loveland's railroad would not only serve as the strategic feeder that they wanted, but also a conduit for mountain trade. The two parties struck a deal where UPRR granted Loveland labor, rails, and rolling stock in exchange for an exclusive trade relationship and interest in Loveland's venture. In addition, Loveland had to demonstrate earnestness by grading the rail beds, furnishing ties, and securing \$600,000 in capital for construction and operations. In 1868, Loveland reorganized his railroad as the Colorado Central (CCRR) to initiate construction and include UPRR officials, who made up half the board of directors. With limited capital and volunteer labor from Golden, CCRR finally began work. The first line extended from Golden northeast down Clear Creek to a proposed junction of the Denver Pacific and Kansas Pacific. Before the construction crew reached the destination, however, CCRR ran out funds and volunteers.⁴¹⁶

Although T.J. Carter and other UPRR officials dominated the CCRR board, UPRR provided no financial support. In addition, president Carter mismanaged the railroad's development, appointed favorites over Loveland's personnel, and ignored local interests. This infuriated Loveland, who came into heated conflict with UPRR directors. The CCRR stagnated through 1869, while Denver Pacific neared its connections with Kansas Pacific in Colorado and UPRR at Cheyenne. The most that CCRR accomplished in 1870 was construction of a roundhouse and freight yard at Golden and completion of the aforementioned line to Kansas Pacific and Denver Pacific.

Colorado Central Railroad: Expansion, 1871-1876

In 1871, CCRR broke free of the controlling but uncooperative UPRR. Through insider manipulation Loveland regained control, removed Carter, fired most of his appointees, and created a new administration. A revised board of directors elected Teller president, Loveland vice-president, and John B. Taft of Boston secretary and treasurer. They immediately restored CCRR into functional order, with the railroad aggressively soliciting business, reducing overhead, paying debts, and realizing a profit for the line between Golden and Kansas Pacific. Loveland and associates revived their original plans to capture mining business in the mountains, where the greatest profits lay. As early as 1868, CCRR chief engineer E.L. Berthoud surveyed a route up Clear Creek with branches to Black Hawk and Idaho Springs, reporting that the route was feasible but costly. A lack of funds initially blocked progress, but a solution quickly

⁴¹⁵ Hall, 1889:424.

⁴¹⁶ Poor, M.C. *Denver, South Park & Pacific*. Denver, CO: Rocky Mountain Railroad Club, 1976, 37; Hauck, 1979:16.

materialized. UPRR was one component, as it still perceived the railroad as an important feeder system and could block rival Kansas Pacific from the mountains. Taking action, UPRR officials improved their relationship with Loveland and offered more rails and rolling stock in exchange for another financial stake. Additionally, Loveland and Teller convinced Gilpin County to provide CCRR with a \$250,000 bond to build the line to Black Hawk and Central City. Last, UPRR officials solicited an additional \$50,000 bond from Clear Creek County to push a branch up to Georgetown.⁴¹⁷

CCRR aggressively pushed construction from 1871 into 1872, but progress was slow because of the formidable conditions presented by Clear Creek canyon. The floor was so narrow and bedrock walls so steep that the rail bed had to be blasted out and retained by masonry walls, with Clear Creek bridged numerous times. By September 1872, CCRR reached the forks of Clear Creek, the gateway to Gilpin County, establishing a station. From there, construction continued up the North Fork to Black Hawk, providing service to the Black Hawk Smelter and one of Colorado's most important mining regions.⁴¹⁸

CCRR did not rest on this achievement and instead grew anxious over potential competitor John Evans. In 1871, Kansas Pacific bought the Denver Pacific and proposed a railroad to Georgetown in hopes of circumventing CCRR and capturing upper Clear Creek. With Kansas Pacific backing, Evans established the Denver, Georgetown & Utah Railroad, surveying a route from Denver. This threat put UPRR and CCRR in a defensive position, but they were unaware that Evans planned the Denver, Georgetown & Utah (DG&U) more as a bargaining tool than an actual railroad. Evans wanted CCRR to bring its mountain traffic directly to Denver and offered to sell the DG&U in exchange. CCRR directors knew they had a major advantage because their railroad was already established. If CCRR could grade a line from its forks station far enough up Clear Creek and establish a presence in the county, Evans would be unable to secure financing. Thus, when Evans presented his offer, Teller prolonged negotiations to buy time. CCRR feverishly pushed a new track up the canyon while officials aggressively solicited \$200,000 in county bonds for service to Georgetown. Once these were secure, Evans cancelled the deal for the DG&U.⁴¹⁹

Even with bonds from Clear Creek County, however, CCRR was not yet ready to finish the line to Georgetown, formally known as the Georgetown Extension. In its attempt to cut off DG&U, CCRR laid rails to the base of Floyd Hill, where the valley widened. There, CCRR established a railhead in 1873, stopped construction, and turned its attention to other matters (see Illustration A 5.1). CCRR directors had little incentive to continue beyond Floyd Hill for several reasons. First, CCRR successfully thwarted competition by winning the county bonds and parking its railhead in the valley. Second, the county had provided the bonds up front instead of awarding upon completion of the Georgetown Extension. Third, the Floyd Hill depot was already overwhelmed with traffic, and the railroad did not need to rustle additional business. Last, the economic panic of 1873 tightened the railroad's finances and not only stopped the Georgetown Extension, but also two other lines that CCRR had been grading north from Golden to join UPRR in Wyoming. Although county residents became angry, they agreed that the existing station was already a vast improvement over the primitive system of wagon roads.

CCRR revolutionized the region by providing an easily accessed station and all-season transportation at lower costs than wagon companies. The prices of goods and industrial materials

⁴¹⁷ Hauck, 1979:21.

⁴¹⁸ Griswold, P.R., Kindig, Richard H., and Trombly, Cynthia. *Georgetown and the Loop*. Denver, CO: Rocky Mountain Railroad Club, 1988, 6; Abbott, et al., 2007:115, 182; Osterwald, Doris B. *High Line to Leadville: A Mile by Mile Guide for the Leadville, Colorado & Southern Railroad*. Lakewood, CO: Western Guideways, 1991, 66; Hauck, 1979:25, 35; Poor, 1976:57.

⁴¹⁹ Abbott, et al., 2007:63; Hauck, 1979:37; Poor, 1976:31, 51, 59.

decreased while variety and volume increased. This proved crucial to mining for three reasons. First, operating costs fell. Second, large machinery and other technology could be hauled in at affordable prices. Third, the rates for shipping ore to smelters at Black Hawk, and even Omaha, Nebraska, were substantially reduced. The net result was that mining outfits were able to pursue lower grades of increasingly complex ore from greater depths than possible before. To illustrate this trend, production of gold and silver in the county steadily rose after 1872. That year mining produced \$25,000 in gold and \$1.5 million in silver. By 1874, it generated \$43,000 in gold and \$2.1 million in silver.

The panic of 1873 halted CCRR's expansion and exacerbated friction between Loveland and UPRR directors. As before, UPRR slowly increased its leverage over CCRR through stock ownership, acquisition of bonds from creditors, and provision of rails and equipment. While Teller, Loveland, and Taft continued holding the company's high offices, UPRR appointed more directors in an attempt to steer the railroad toward their priorities. UPRR rasped over Loveland's inability to complete a line to Wyoming, and until that track could be utilized, UPRR continued losing transcontinental traffic to Kansas Pacific. Colorado was, however, only part of a larger problem that UPRR had with Kansas Pacific, which robbed traffic throughout its system. In 1873, Jay Gould, who now controlled UPRR, decided to end this competition. Gould initiated a rate war that drove Kansas Pacific into bankruptcy in 1875, forcing negotiations. Gould and Kansas Pacific officials came to a complex agreement involving CCRR, although no one at CCRR was aware of this. In control of Kansas Pacific, Gould demanded most of Colorado's transcontinental business for UPRR, and as a token, he offered the CCRR to Kansas Pacific, provided it provided the CCRR with the necessary funding to complete the lines to UPRR in Wyoming, fulfilling its role as a feeder. The two railroads finalized the deal, and UPRR conveyed its majority interest in CCRR to Kansas Pacific. Despite this, UPRR still retained significant influence through CCRR's board of directors.⁴²⁰

At the same time, Kansas Pacific attempted to increase its ownership over CCRR by acquiring its loans, placing CCRR in debt to Kansas Pacific. Officials approached those counties that held large CCRR bonds, including Clear Creek, Gilpin, Boulder, and Weld, offering to buy them. But because Kansas Pacific could not afford face value, its officials engaged in trickery. They explained that CCRR was on the brink of bankruptcy and that CCRR's debts would be forgiven and the bonds rendered worthless. They pledged to buy the bonds for twenty percent of their original value, better than nothing.⁴²¹

Loveland and partners learned of these manipulations and vowed to extricate CCRR. In 1876, Loveland and Teller seized an opportunity before UPRR and Kansas Pacific finalized their transfer. Loveland organized the annual company meeting, sending out a last-minute announcement that it was to be held in Colorado. As Loveland and associates had hoped, most UPRR officials were unable to attend, leaving a majority of pro-Loveland individuals at the meeting. They promptly voted UPRR officials off the board, appointing instead members that were hostile to UPRR. The new board declared the stock owned by UPRR and Kansas Pacific invalid and elected Loveland president. Loveland did not stop with political control, dispatching armed men to take the railroad by force. He had full support of the counties and their sheriffs, who realized that CCRR would remain solvent, continue service, and that their bonds would retain full value.⁴²²

⁴²⁰ Abbott, et al., 2007:43; Hauck, 1979:58; Jessen, 1982:31; Poor, 1976:63.

⁴²¹ Poor, 1976:64.

⁴²² Hauck, 1979:58; Jessen, 1982:33; Poor, 1976:64.

UPRR retaliated through its only available means, demanding payment on debts in hopes that CCRR would default. CCRR fought UPRR in court for a year, but the case was too tangled for ready resolution. Unwilling to invest further in the battle, UPRR finally conceded defeat and admitted that CCRR was now independent. UPRR did not, however, sever relations because it still wanted CCRR to serve as a feeder for its Wyoming line. Instead of trying to wrest control, UPRR officials recognized Loveland's power and solicited him as an ally. UPRR revived its original policy of underwriting CCRR and helping the railroad finish the planned extensions. The first step was to complete the line to Wyoming so Colorado traffic could begin flowing to UPRR's transcontinental track.

Colorado Central Railroad: Georgetown Extension, 1877-1880

During the late 1870s, Loveland and UPRR, previously at odds, celebrated the completion of several key projects. First, CCRR finally finished its piedmont line from Golden north to UPRR transcontinental track at Colorado Junction, Wyoming, in 1877. This shifted the balance of power among Colorado's railroads in favor of UPRR, at the expense of Kansas Pacific and Denver interests. CCRR itself benefited substantially because it now provided service to the growing agricultural communities of Boulder, Longmont, and Fort Collins. The same year, Loveland finished the Georgetown Extension from the Floyd Hill railhead to Georgetown (see Illustrations A 5.2 - A 5.4). The climate was right because the national economy had recovered from the mid-1870s depression, capital was available, and Clear Creek County was in the midst of a mining boom. When the first train arrived at Idaho Springs in June, 1877, the town celebrated with speeches, a parade, and other events. Work crews had an easy time pushing farther up gently sloped Clear Creek valley during the summer, establishing the depot of Swansea near Empire, and reaching Georgetown in August. Georgetown residents turned out in number to greet the first train.⁴²³

Georgetown perceived the end-of-the-line facilities that CCRR built for freight, passengers, and maintenance as an icon of prosperity. A large combination depot handled a flow of people and goods, with loading docks and yard space facilitating bulk freight including sacked ore and mill concentrates. Coal bins and a water tower replenished locomotives, and sheds stored supplies and equipment.

As expected, CCRR had a dramatic impact on Clear Creek valley, its mining industry, and its settlements. Whatever improvements the Floyd Hill railhead brought in 1873 were amplified in 1877. The price of domestic goods and mining supplies decreased farther, and mining companies shipped higher tonnages of ore than any time before to Black Hawk for treatment. In addition to providing economic benefits, CCRR was also a conduit by which culture and sophistication made their way into the county.

CCRR brought a new type of traveler that became an important economic engine. Specifically, the railroad put the legendary Rocky Mountains within reach of tourists, while businesses in the county now had the resources to entertain them. To this end, Frank Fossett observed in his 1880 travel guide to Colorado:

At present, the most entertaining trip that can be made, and the quickest and cheapest, is that by way of the Colorado Central railway from Denver to the mining cities of Central, Black Hawk, Idaho, and Georgetown. In this the tourist gets the greatest variety for the least expenditure of

⁴²³ Abbott, Dan. *Stairway to the Stars: Colorado's Argentine Central Railway*. Ft. Collins, CO: Centennial Publications, 1977, 14; Morgan, Gary. *The Georgetown Loop: Colorado's Scenic Wonder*. Fort Collins, CO: Centennial Publications, 1976, 12; Abbott, et al., 2007:291; Griswold, et al., 1988:6; Hauck, 1979:59; Osterwald, 1991:68; Poor, 1976:67.

money that any single excursion affords that actually enters the mountains any distance. While this canyon may not compare with the Royal Gorge in massive grandeur, the tourist can derive infinite pleasure from the many and varied sights that continually offer themselves *en route* and at adjacent points on either hand. There is no finer prospect than that offered from Gray's lofty summit, no more beautiful lakes than those near Georgetown, and nowhere in Colorado are mines so deep or mills so numerous as on the headwaters of Clear Creek. There are excellent hotels at all of the towns named, and one of the most noted pleasure resorts, with fine drives and livery turnouts, can be found on this line at Idaho Springs.⁴²⁴

With CCRR nearly complete in both the mountains and on the plains, Loveland and partners relaxed slightly and enjoyed the railroad's meteoric rise to prosperity. In 1878, they added an extension that cemented the railroad's importance to the mining industry. In particular, CCRR added stubs and sidings at the new Argo Smelter north of Denver. Nathaniel Hill erected the Argo to replace his Black Hawk Smelter, which was overwhelmed with business and had no room for expansion. Hill chose the site north of Denver because fuel coal and water were readily available, and it was centrally located and adjacent to CCRR's tracks. The fact that Hill had long been a part of the mountain community and knew Loveland and Teller probably influenced his decision to build the Argo adjacent to their railroad. As a result, CCRR had a monopoly on Clear Creek County smelter traffic. Further, when the Denver & Rio Grande (D&RG) or Denver, South Park & Pacific (DSP&P) railroads brought ore from areas they served, they had to use CCRR tracks and pay trackage fees. Clear Creek County was one of the greatest beneficiaries of the Argo arrangement. Not only did the new smelter reduce the fees that mining companies paid, but it also treated low-grade ores more efficiently than any other facility. Because CCRR provided direct service from the county, the mining companies enjoyed a decrease in freight rates.⁴²⁵

Loveland and associates were unable to rest for long because the Leadville boom stirred a new wave of railroad company agitation. Discoveries of silver stimulated a major rush in 1877 with a mining industry taking shape during 1878 that saw companies extracting silver in astounding volumes. Railroad investors and officials correctly forecast that Leadville was destined for greatness and plotted how to capture its growing freight and passenger business. Within the year, UPRR, DSP&P, and D&RG began an expensive race to Leadville. The Arkansas River valley, ascending from the south, was the only natural gateway to Leadville, landlocked in a high mountain valley. D&RG was in the lead because it possessed the Arkansas River route as well as a section of track in Royal Gorge. DSP&P, slightly behind, was busy grading the second-best route up the South Platte River, across South Park, and down into the Arkansas River valley.

This left UPRR with the least desirable route over the Divide in Clear Creek County. The only reason that UPRR entertained the idea was that CCRR's end-of-the-line in Georgetown could serve as a starting point. However, crossing the Divide would be extremely costly, time-consuming, and present special engineering problems, if a railroad could be built at all. When Jay Gould weighed the options, he outlined a two-fold plan for reaching Leadville. He both initiated crossing the Divide in Clear Creek County and attempted to acquire either of the other railroads in hopes that one these actions would succeed. In 1878, Gould began buying stock in D&RG and DSP&P and also secured the services of CCRR official and engineer E.L. Berthoud for the Clear Creek crossing. UPRR directors organized the Georgetown, Leadville & San Juan Railroad to provide Berthoud with resources as he led a survey party into the field. Berthoud

⁴²⁴ Fossett, Frank. *Colorado: Its Gold and Silver Mines, Farms and Stock Ranges, Health and Pleasure Resorts*. New York, NY: C.G. Crawford, 1880, 56.

⁴²⁵ Hauck, 1979:60.

determined that the best route ascended Clear Creek to Silver Plume, continued up Clear Creek to Loveland Pass, and crossed under the Divide through a tunnel. From there, the route descended the Snake River into Summit County. As expected, Berthoud reported that the cost would be immense and the project would take time, especially because the tunnel would be thousands of feet long.⁴²⁶

Furthering the plan, UPRR leased CCRR from Loveland and associates in 1879. Gould overtly did so on the premise that CCRR was a crucial feeder for UPRR, although he tacitly wanted control of the railroad as a key link in his Leadville push. UPRR then replaced Loveland and associates with S.H.H. Clark, a UPRR director, as president; C.C. Welch as vice-president; and Berthoud as secretary. UPRR engineer Jacob Blickensderfer assumed Berthoud's duties and spent much of the year formally surveying a grade to Leadville. The short but tight gulch between Georgetown and Silver Plume was the only section as difficult as Loveland Pass. The gulch which carried Clear Creek down 640' from Silver Plume was too steep for conventional railroad equipment and also too narrow for the meandering route often designed to overcome such obstacles. Blickensderfer confronted the problem with a feat of engineering still celebrated today. Specifically, he planned a serpentine grade with hairpin curves equivalent to three full circles, and a complete loop where the track crossed over itself. While the distance from Georgetown to Silver Plume was around one and one-half miles via a steep mountain road, Blickensderfer's numerous curves extended the proposed grade an additional three miles. At this distance, the ascent would be five percent, the maximum for locomotives.⁴²⁷

Gould made even better progress toward Leadville through influence over the existing railroads. He negotiated with John Evans for DSP&P in 1879, gaining control over that railroad the next year. With his Leadville objective nearly realized, Gould shelved his plan to extend CCRR, but wisely kept it as an option should trouble arise in the future. Problems did arise within a short time, forcing Gould to reactivate his plan to cross the Divide in Clear Creek County.

Georgetown, Breckenridge & Leadville Railroad: Built, 1881-1884

When Gould began DSP&P service to Leadville in 1880, the railroad did not possess its own track up the Arkansas River Valley. Instead, DSP&P saved capital by tying into the existing D&RG line near Buena Vista, paying a trackage fee for joint use to Leadville. In exchange, DSP&P allowed D&RG joint use of another track into the Collegiate Mountains. As long as DSP&P and D&RG cooperated, the agreement benefited both railroads, but they were competitors and the working relationship lasted only a brief time. (A detailed history of the joint agreement and its disintegration are discussed in detail below). UPRR directors came into conflict with D&RG over the Leadville line use fees, and they realized that D&RG could shut DSP&P out of Leadville altogether if the disagreement became too heated.

In response, Gould renewed his interest in building a line to Leadville, with three apparent options. One was a new track paralleling the shared D&RG line up the Arkansas River. This required the least amount of new construction, but it was longest in distance from Denver. The second was to push a new line from DSP&P terminal at Como in South Park northwest to Breckenridge in Summit County. From there, the line went north to Ten Mile Creek, south up the creek to Fremont Pass, and down to Leadville. The third option was the CCRR extension that Blickensderfer surveyed in 1880. Curiously, Gould eliminated the first choice and

⁴²⁶ Abbott, et al., 2007: Griswold, et al., 1988:15.

⁴²⁷ Abbott, et al., 2007:319, 380; Griswold, et al., 1988:15, 18, 33; Hauck, 1979:61, 74; Morgan, 1976:12, 18; Poor, 1976:75, 86.

simultaneously pursued the last two. Both would be extremely expensive, require considerable time, and engender high operating costs when finished. The advantage, however, was that either extension could dominate the growing mining trade in Summit County.

In 1881, UPRR officials organized the Georgetown, Breckenridge & Leadville Railway (GB&L) to build the CCRR extension (see Illustrations A 5.5 and A 5.6). Blickensderfer, UPRR chief engineer, appointed Robert B. Stanton as GB&L chief engineer and Frank A. Maxwell as field engineer. In the mountains, outdoor construction was usually a seasonal endeavor, but not according to UPRR. In January 1882, Blickensderfer and Stanton gathered a huge workforce and began construction. The workers were so numerous that they filled nearly all available housing in Silver Plume and crowded into Georgetown's boardinghouses. Many came from elsewhere, while some were local miners hired to drill and blast in the rocky sections. Even though UPRR offered a wage of \$5.00 per day (much higher than the regional average) Stanton found that the workers were difficult to retain. The reason was that once their immediate needs were met, the workers left without notice in response to gold and silver strikes elsewhere.⁴²⁸

The crews started in Georgetown, pushed their way up the gulch, and quickly encountered trouble. A Mr. McLain owned a toll road up Leavenworth Gulch, which the railroad had to cross with fill. The engineers tried to secure a crossing from McLain, but he refused because he desired quiet and did not want the road severed and toll income lost. When UPRR bullied McLain, he blockaded the route, took up arms, and kept vigilance. The sheriff demanded that McLain provide access, but he still refused to cooperate and went to jail. As the standoff caused a significant delay, Stanton directed his crews to move west to other sections of the grade in the interim.⁴²⁹

By September 1882, workers finished the bed as far as the temporary terminus at Bakerville. The GB&L, however, was far from completion as the rockwork, bridges, and fills in the gulch slowed progress. The loop was the greatest impediment because it incorporated a steel trestle known as the High Bridge built to exacting specifications. In April 1883, track gangs finished the grade and prepared the masonry abutments for the bridge. UPRR contracted with the Phoenixville Bridge Company to prefabricate the structure, ship it in pieces to Georgetown, and assemble them across a constriction in the gulch known as Devil's Gate. Phoenixville began assembly in October but encountered a number of problems. First, the bridge abutments proved to be 8" too high for the preformed ironwork and had to be reduced. Second, the height of the bridge scared off experienced riveters, who were in short supply, and they were replaced with general labor. According to railroad historian Gary Morgan, "The Georgetown *Courier* reported that, despite the offer of good wages, a number of workers simply refused to set foot on the 'Devil's Gate' construction site once they saw it."⁴³⁰ Because the general laborers had little knowledge of riveting, their work ranged in quality from substandard to defective.

The third and most grievous problem was that some of the bridge components were assembled backwards! In particular, the support piers were erected slightly off their planned locations and the north pier was accidentally transposed with the south one. As a result, Stanton refused to accept the bridge as built and ordered Phoenixville to rectify the problems. In December, despite high winds and freezing conditions, Phoenixville workers reassembled the bridge according to specifications. As built, the bridge was 300' long, an 18½ degree curve, and led to a massive peninsula of rock known as the Big Fill, which featured a 30 degree curve. The

⁴²⁸ Ellis, Erl H. and Ellis, Carrie Scott. *The Saga of Upper Clear Creek: A Detailed History of an Old Mining Area, Its Past and Present*. Frederick, CO: Jende-Hagan Book Corporation, 1983, 192; Poor, 1976:79.

⁴²⁹ Abbott, et al., 2007:374; Griswold, et al., 1988:34.

⁴³⁰ Morgan, 1976:16.

High Bridge was finished at the end of January 1884, with workers completing the GB&L shortly after.⁴³¹

The first commercial train rolled into Silver Plume in March, inciting a celebration on par with the one held in Georgetown in 1877. The loop, bridge, and fill were recognized as an engineering marvel, as nothing like this assembly had yet been built for a railroad. The line became known worldwide as the “far famed Georgetown Loop” and elevated the GB&L, and CCRR by association, to special status both among railroads and tourist attractions. All this came at the price of \$254,700, which was high for around eight miles of track.⁴³²

GB&L impacted Silver Plume and Bakerville the same way that CCRR affected Georgetown. The decrease in freight rates and direct smelter service made lower grades of ore economical to produce in local mines and allowed the mining companies to install better equipment. The cost of living in town fell, and a wave of tourists swarmed the area during the summer. GB&L also opened the upper reaches of Clear Creek Valley for economic development. Bakerville, with its stage station, concentration mill for the Baker Mine, and several small sawmills, was originally designated the terminus. To compete for business that GB&L was sure to bring, railroad officials established the adjacent townsite of Graymont, named for Gray’s Peak, in 1883. Graymont grew quickly and attracted service establishments catering to tourists who came to rough it amid Gray’s and Torrey’s peaks. Mr. and Mrs. J.D. Jennings opened the Jennings Hotel, other individuals ran the Fox and Hounds tavern, GB&L parked a box car as a temporary depot, Stevens Mining Company erected ore bins along the railroad track, and the Post Office Department established a post office. When CCRR began running trains to Graymont in 1884, it cemented the hamlet’s role as a destination for mountaineers by providing guides and horses for day trips up to the peaks.⁴³³

Almost from its beginning, Bakerville was a principal source of lumber for Clear Creek Valley, and the arrival of GB&L allowed local industry to boom. Not only did GB&L carry lumber to the principal towns and mining districts in the county, it also facilitated direct access to the Denver market, which preferred fir and spruce to the pine brought in from elsewhere. By 1887, the amount of logging in the upper portion of the valley reached unprecedented levels.⁴³⁴

In addition to logging and tourism, the railroad fostered one other industry. In particular, two separate groups became aware of UPRR’s plan to tunnel through Loveland Pass and started their own bores with the intent of selling them to GB&L at high prices. Marcus M. “Brick” Pomeroy, an adept speculator, organized the first and longest lived scheme. He, Albert S. Whitaker, and L.C. McKenzie established the Atlantic-Pacific Tunnel Company in 1880, promoting a five-mile tunnel under the Divide. The company started the bore at the north base of Kelso Mountain, mostly for show, and planned a southwest course to Peru Creek in Summit County. To entice investors, Pomeroy claimed that the tunnel would be not only for the railroad, but also would penetrate ore veins concealed underneath the Gray’s and Torrey’s peaks area.⁴³⁵

Loveland and associates launched their own venture with the same intent as Pomeroy. They organized the Loveland Pass Mining & Railroad Tunnel Company in 1881 and drove the tunnel for around a year while UPRR considered what to do with GB&L. When DSP&P reached Leadville in 1882, Loveland suspended work on suspicions that GB&L would not be extended

⁴³¹ Abbott, et al., 2007:378, 380; Griswold, et al., 1988:35, 38; Hauck, 1979:77; Morgan, 1976:14, 18.

⁴³² Abbott, et al., 2007:380; Ellis and Ellis, 1983:193; Griswold, et al., 1988:37; Hauck, 1979:78, 80; Morgan, 1976:15; Poor, 1976:75.

⁴³³ Ellis and Ellis, 1983:192, 215, 218.

⁴³⁴ Ellis and Ellis, 1983:150, 153.

⁴³⁵ “An Important Mining Tunnel” *Mining & Scientific Press* (10/14/82) 241; *Colorado Mining Director, 1883*. Denver, CO: The Colorado Mining Directory Co., 1883,118; Ellis and Ellis, 1983:178.

into Summit County.⁴³⁶ Loveland was correct about GB&L proceeding no further, but Pomeroy continued his project anyway. When his first company ran out of funds, Pomeroy secured eastern capitalists to reorganize the project as the Atlantic-Pacific Tunnel & Gray's Peak Railway Company in 1882. After two years of empty promises in exchange for stock assessments, the investors recalled their loans in 1884 and forced the company into bankruptcy. The property was sold in foreclosure to Whitaker and Clear Creek County mining investors D. Washburn and Diamond Joe Reynolds. They organized the Atlantic-Pacific Railway Tunnel Company, not for the railroad aspect, but because Diamond Joe saw the tunnel as a means of undercutting his mining claims on Kelso Mountain. Pomeroy, however, did not give up on the scheme because the project provided his salary. In 1887, Pomeroy found British investors who ideally suited his needs because of their great distance from Clear Creek County. He leased the existing tunnel from Reynolds and resumed work at the heading, now thousands of feet from the portal. By this time, locals suspected the project was a scam, and yet, Pomeroy's financiers provided him with enough money to continue operations for five more years.⁴³⁷

Originally, UPRR directors hoped that Graymont would become an important fuel and water stop for trains climbing over the Divide and into Summit County. This was not to be, however. UPRR finished DSP&P High Line into Summit County and around to Leadville in 1883. The directors formally announced that GB&L would not be extended over the Divide and that the Clear Creek County system would be left as it was.⁴³⁸

Clear Creek Railroad System: Peak Years, 1885-1904

After UPRR finished GB&L in 1884, the entire Clear Creek County railroad system entered a quiet time of prosperity. UPRR operated CCRR and GB&L as a single system, sharing locomotives, rolling stock, and schedules. Regular freight trains hauled domestic goods, fuel coal, and industrial supplies up from the plains and carried ore and mill concentrates down to the smelters. Tourists came from all over the nation to stay in the region's many resorts, ride the GB&L Loop, and hike among the high peaks. Tourist demand grew so much during the late 1880s that CCRR scheduled six to seven passenger trains per day from Denver to Silver Plume.

The principal changes after 1884 occurred in offices far from Clear Creek County. In 1890, UPRR began to sag under a backlog of debt, feuds with other transcontinental railroads, internal struggles, and deferred maintenance. Company officials decided to separate UPRR from its subsidiaries to improve efficiency of management, keep railroads in serious trouble off its books, and protect profitable lines. UPRR president Charles F. Adams created the Union Pacific, Denver & Gulf Railway in 1890 as an umbrella for its Colorado carriers. This separate holding company managed CCRR, GB&L, DSP&P, and Denver, Texas & Gulf Railroad as one system, but allowed them to maintain their separate identities. As before, CCRR and GB&L were recognized together as the Colorado Central, and UPRR was wise to keep this identity because it was popular among tourists. UPRR conveyed its Denver and Golden yards to the Union Pacific, Denver & Gulf Railway, consolidating its own support facilities into the extensive UPRR center at Cheyenne. This division became important in a few years because it allowed the Colorado system to function independently.⁴³⁹

⁴³⁶ Hauck, 1979:77.

⁴³⁷ Griswold, et al., 1988:29, 182; Hauck, 1979:79; "Latest Mining News" *Rocky Mountain Mining Review* (10/16/84): 9.

⁴³⁸ Hauck, 1979:79; Poor, 1976:77.

⁴³⁹ Digerness, David S. *The Mineral Belt: Volume II, Old South Park, Across the Great Divide*. Denver, CO: Sundance Books, 1978, 50; Abbott, et al., 2007:400; Hauck, 1979:103, 107; Jessen, 1982:165; Osterwald, 1991:83; Poor, 1976:81.

The Union Pacific, Denver & Gulf Railway was still tied to UPRR in management and finances, allowing UPRR to use it in a twofold strategy practiced by many parent railroad companies. First, UPRR cut operating costs, deferred maintenance, and kept the savings for itself. Second, UPRR also siphoned general income to service its own debts. The entire UPRR assemblage, including CCR and GB&L, suffered financially and deteriorated as a result. The principal casualty in Clear Creek County was Graymont. UPRR ended service to the hamlet in 1890, claiming that tourist and lumber traffic were insufficient to offset the line's operating costs. Graymont withered afterward, and the Jennings Hotel operated only during the summer.⁴⁴⁰

A synergy of forces finally pushed the mighty UPRR into bankruptcy in 1893. Obligations on stocks and debts totaling \$450 million undermined the railroad's foundation during the early 1890s. Then the Silver Crash of 1893 and resultant economic depression pushed the giant over the edge as creditors and stockholders recalled loans and dividends. UPRR and its subsidiaries fell to receivers, who were also the same company directors that ruined the railroad. The stockholders of the Colorado subsidiaries howled in protest, claiming that UPRR would bilk the system and degrade its worth. Thus, the courts appointed Frank Trumbull of Denver as receiver, with stockholders welcoming him because of his reputation as an able manager. Trumbull accomplished the task that responsible railroad receivers were supposed to complete: returning troubled carriers to profitability. He reversed UPRR's policies of diverting revenue and deferring maintenance, instituting improvements instead. During the latter half of the 1890s, he ordered new locomotives and rolling stock, aggressively solicited traffic, promoted tourism, and completed repairs to the Clear Creek system.⁴⁴¹

Once the Union Pacific, Denver & Gulf was in a condition to operate independently, it was auctioned off. In 1898, a group of investors bought the railroad, organized the Colorado & Southern Railway Company (C&S), and appointed Trumbull president because of his excellent record and familiarity with the system. Trumbull continued to reinvest some of the profits in efficiency and improvements. In 1900, he replaced worn rolling stock with a fleet of freight cars and passenger coaches. He also built new shops, a roundhouse, and yard west of Denver to replace those at Golden. High in the mountains, at the far end of the CCR system, workers erected a waiting pavilion and restaurant at Silver Plume for tourists. In 1902, Edwin T. Hawley, who controlled the Minneapolis & St. Louis and Iowa Central railroads, acquired controlling interest in C&S, but did little to change Trumbull's management style.⁴⁴²

Tourist traffic on the Clear Creek system was high enough during summer to warrant several daily express trains. However, overall revenue for the system declined despite Trumbull's improvement campaign. The Clear Creek system shared the same problem suffered by many mining-dependent railroads: when the mining industry ebbed, so did railroad income. After around forty years of continuous gold and silver production, the output of Clear Creek County's mines began a downward slide. In 1896, county mines yielded around \$800,000 in gold and \$1.6 million in silver, with figures gradually dropping to \$600,000 in gold and \$500,000 in silver eight years later.⁴⁴³ The decrease in ore production meant less railroad freight and hence a reduction in income. Given this, Trumbull was wise to promote tourism around the turn of the century as a sustainable and growing source of traffic.

⁴⁴⁰ Abbott, et al., 2007:400; Ellis and Ellis, 1983:223; Hauck, 1979:80; Poor, 1976:81.

⁴⁴¹ Abbott, et al., 2007:402; Digerness, 1978:53; Hauck, 1979:103; Jessen, 1982:166.

⁴⁴² Chappell, Gordon S., Hauck, Cornelius W., and Richardson, Robert W. *Colorado Rail Annual No.12: The South Park Line, A Concise History*. Golden, CO: Colorado Railroad Museum, 1974, 73; Abbott, 1977:15; Digerness, 1978:61; ; Hauck, 1979:107; Morgan, 1976:21; Osterwald, 1991:93.

⁴⁴³ Henderson, Charles W. *Professional Paper 138: Mining in Colorado: A History of Discovery, Development, and Production*. Washington, D.C.: U.S. Geological Survey, Government Printing Office, 1926, 109.

Argentine Central Railroad: Added to System, 1905-1911

In 1905 the Clear Creek system received its last significant addition, temporarily addressing the problem of declining revenues. The Argentine Central Railroad, built to the Argentine Mining District, both funneled ore to CCRR and made the system more attractive than ever to tourists (see Illustration A 5.7). The Argentine Mining District, on the Continental Divide southwest of Georgetown, hosted one of Colorado's early silver rushes. During the late 1860s and 1870s, mining companies extracted ore from the upper reaches of the district's veins until the shallow payrock was gone. The district then remained relatively quiet until the late 1890s, when several rich discoveries renewed interest in the deeper portions of the veins. Gradually, investors local to Clear Creek County reopened the largest mines and brought several new properties into production.

Edward J. Wilcox, owned several mines in Silver Plume and Idaho Springs. When Argentine showed signs of a revival, Wilcox took an interest in the district and acquired some of the important properties including the Stevens, Huckleberry, Independence, and Wheeling. He also purchased shares of the Paymaster and Santiago mines, the most promising and greatest producers. In 1901, he organized the Waldorf Mining & Milling Company to consolidate and operate the mines, and to drive the Wilcox Tunnel to the Santiago ore system. At the same time, R.C. Vidler, another local investor, began developing a new mine near the Wilcox Tunnel. His was the Vidler Tunnel, which, depending on the source, was either a deep tunnel projected to undercut an ore system or another railroad bore intended to penetrate the Divide. Vidler began his tunnel in 1902, and the project contributed to the area's boom atmosphere.⁴⁴⁴

A group of Colorado investors, some interested in Argentine's mines, felt that the revival could support a new railroad, despite exorbitant construction costs. Argentine was above treeline, difficult to reach even by road, and offered no routes favorable by conventional standards. In spite of these challenges, in 1904 they organized the Silver Plume & Gray's Peak Railway & Reduction Company and completed a mile of rail bed from Bakerville before reality set in. Wilcox picked up where they left off. He had a direct interest because a railroad would lower freight costs for his mining company and increase its worth among investors.⁴⁴⁵

In 1905, Wilcox began the daunting project with capital from James McGee, Jacob Fillius, S.E. Wirt, and George Richardson, all successful mining investors. Adamant that the railroad had to be finished that year, Wilcox put crews to work on Leavenworth Mountain weeks before the Argentine Central Railroad was formally organized. Grading proved slower than expected, and the approaching winter threatened Wilcox with more delay. In response, he increased the workforce and sent teams to simultaneously grade different segments along the route and join them later. When winter began, Wilcox did not relent and kept the crews at work into January 1906, when they completed the track to the Wilcox Tunnel.⁴⁴⁶ Wilcox celebrated with a golden spike ceremony at the tunnel and appointed W.H. Stillwell as manager. Stillwell came with experience as former superintendent of the Rock Island Railroad and manager of the Uintah Railroad in Utah. Wilcox returned to his mining interests but maintained strong influence over the railroad's operations. Suspending service on Sunday was one of Wilcox's unusual decisions, based on his personal values as a reverend. Wilcox ordered the railroad to respect the

⁴⁴⁴ *Colorado Mining Directory, 1901*. Denver, CO: Wahlgreen Printing Co., 1901, 49; Griswold, et al., 1988:147; "Mining News" *Mining Reporter* (5/16/01): 325.

⁴⁴⁵ Abbott, 1977:22.

⁴⁴⁶ Abbott, 1977:22, 26, 33; Griswold, et al., 1988:61; Hauck, 1979:106.

traditional day of rest, even though Sunday was one of the most popular travel days for tourists. In so doing, the railroad lost a considerable amount of business.⁴⁴⁷

Despite the restrictive policy, freight and tourist traffic was high during the railroad's first years. The freight consisted of mining supplies and machinery hauled up from Silver Plume and ore and mill concentrates sent down to smelters. As conceived, Wilcox used the railroad as a collection system for the district's principal mines, with the Wilcox Tunnel and Waldorf Mill serving as a focal point for traffic. The strategy maximized the railroad's income and increased the importance of the settlement at the tunnel, which Wilcox named after himself. Engineer Arthur H. Osborne in turn dispatched construction gangs to grade feeder spurs to the principal mines. As the winter of 1906 permitted, the workers built a spur south to the Vidler Tunnel and a separate set of switchbacks up McClellan Mountain to the Alaska, Bonham, Mammoth, Kitty Owsley, and Manhattan mines. The owners of the Santiago contributed to Wilcox's system by building an aerial tramway down to the mill.⁴⁴⁸

Wilcox was aware that the railroad had enormous potential for tourism because of the grandeur of its destination and proximity to Gray's and Torrey's peaks. He and Osborne prepared in advance of the 1906 tourist season. Wilcox changed the name of his settlement to Waldorf, secured a post office, and built a hotel with enough amenities to satisfy tourists. Osborne extended the McClellan Mountain zigzag past the Santiago Mine to the summit, where tourists could enjoy excursions from a pavilion. Wilcox also placed orders for special observation cars.⁴⁴⁹ The Argentine Central finally opened for regular service when enough snow cleared, although the spur to the top of McClellan Mountain was not yet finished. Immediately, the railroad became renowned for two significant achievements. First, the industry recognized the unusually rapid progress through some of the worst topographic and weather conditions faced during railroad construction. Second, the line was the highest in North America, which increased its tourist draw (see Illustrations A 5.8 and A 5.9).⁴⁵⁰

Simultaneously, the railroad benefitted the Argentine district, increased traffic on the CCRR system, and boosted the county's economy. Out of self interest, CCRR management encouraged the Argentine Central by providing labor, loaning rolling stock, and switching passenger cars directly onto the Argentine Central track. Both railroads cooperated in terms of tourism promotion. The Argentine Central advertised CCRR and the Loop in its publications, while CCRR advertised the Argentine Central and McClellan Mountain excursion. By August 1906, the Argentine Central reached the mountaintop and was officially complete. Tourists could board a CCRR train in Denver at 8:00 A.M., transfer to the Argentine Central, enjoy McClellan Mountain, and return to Denver by 7:00 P.M.⁴⁵¹

The Argentine Central returned favors to CCRR by sending high volumes of ore down from Waldorf and onto the CCRR line. As Wilcox planned, short trains collected ore from most district mines and shunted it to the Waldorf Mill, where it was reduced to concentrates. During summer 1906, the railroad carried down as much as fifty tons of concentrates per day, forwarded by the CCRR to the smelters north of Denver. Not all mines sent their ore to the Waldorf Mill, and instead some, such as the Santiago, relied on the Argentine Central to transfer material to mills in Silver Plume for concentration.⁴⁵²

⁴⁴⁷ Abbott, 1977:35, 44; Griswold, et al., 1988:61.

⁴⁴⁸ Abbott, 1977:36, 49, 57; Griswold, et al., 1988:62; Hauck, 1979:106; "Mining News" *Mining Reporter* (11/15/06): 501.

⁴⁴⁹ Bauer, William H., Ozment, James L., Willard, John H. *Colorado Post Offices: 1859-1989*. Golden, CO: The Colorado Railroad Museum, 1990, 148; Abbott, 1977:40, 47.

⁴⁵⁰ Abbott, 1977:35, 54.

⁴⁵¹ Abbott, 1977:53, 70; Griswold, et al., 1988:147.

⁴⁵² Abbott, 1977:50.

Like many Colorado mountain railroads, the Argentine Central began experiencing financial problems shortly after completion. The railroad turned a profit in 1906 but went into deficit the following year. Wilcox's Sunday suspension and a complete shutdown during the winter reduced the railroad's annual income. Wilcox was willing to accept a slight loss, however, because the railroad played a central role in his small mining empire. Curiously, British investors offered Wilcox a handsome \$3.5 million for his entire assemblage of mines, mills, and the railroad in 1907, but Wilcox proudly refused. He came to regret this decision in 1909 when his empire began to crumble. Wilcox's mines were not as productive as hoped, most other operations ran out of ore, and the mill began to run only intermittently instead of constantly.⁴⁵³ To make matters worse, the relationship between Wilcox and C&S turned hostile and further eroded the earning power of the Argentine Central. In 1908, the Burlington & Quincy Railroad Company purchased C&S, including CCRR and GB&L, and sought ownership of the Argentine Central, as well. Wilcox refused to sell, even though the Argentine district was in decline, and instead began a rate war with Burlington & Quincy. Wilcox was no match for Burlington & Quincy and its deep pockets. In 1909, Burlington & Quincy raised its transfer and freight rates on Wilcox, who increased his passenger fares to discourage tourist traffic. This move cost Wilcox dearly because his railroad was isolated and unable to outlast Burlington & Quincy. When the economic drain became too much, Wilcox sold the Argentine Central at a heavy loss, but not to Burlington & Quincy out of spite.⁴⁵⁴

In 1909, Denver mayor Robert W. Speer, Governor John F. Shafroth, Richard H. Malone, and A.J. Woodruff bought the Argentine Central under the Gray's Peak Scenic Development Company. With the railroad came assets such as tourist and mining business, but also significant debt. The Denver investors understood the centrality of tourism and planned improvements such as a spur track, observation structure, and hotel near the top of Gray's Peak. The venture was doomed from the start because investors knew little about the realities of running a mountain railroad. The year 1909 was almost a complete loss because Speer and associates started service too late in the season, and the following year was not much better due to lack of promotion. At the same time, creditors demanded payment on overdue loans, filed lawsuits, and convinced the Colorado Supreme Court to place the railroad in the receivership of John Q. Newton in 1911. He resumed meager service while bond holders attempted to buy the railroad.⁴⁵⁵

The rest of Wilcox's mining empire collapsed at the same time that Argentine Central went bankrupt. Suspension of the railroad impacted most of his mines in the district, which were failing anyway. Without rail service to Waldorf the settlement saw no tourists or movement of ore, the hotel closed, and the Post Office Department revoked the post office in 1912. A year later, the Central Bank & Trust Company foreclosed on the Waldorf company and assumed its assets. Wilcox regretted his decision to ignore the offer made by the British investors in 1907.⁴⁵⁶

Clear Creek Railroad System: Gradual Decline, 1912-1920

Clear Creek County's railroad system ultimately depended largely on mining, and so when ore production slowed during the 1910s, so did its business. The Argentine Central, the system bellwether, suffered the most. When the railroad went bankrupt in 1911, Santiago owner William Rogers realized that his operation might fail without its service. To save his mine, Rogers organized the Georgetown & Gray's Peak Railway Company, drew in Denver investors

⁴⁵³ Abbott, 1977:73.

⁴⁵⁴ Abbott, 1977:76; Abbott, et al., 2007:403; Digerness, 1978:72; Osterwald, 1991:94.

⁴⁵⁵ Abbott, 1977: 79, 83; *Georgetown Courier* (6/12/09); Griswold, et al., 1988:63.

⁴⁵⁶ Bauer, et al., 1990:148; Ellis and Ellis, 1983:114.

William Barth and W.S. Iliff, and bought the defunct carrier at the fire sale price of \$20,000.⁴⁵⁷ Rogers and partners operated the Argentine Central during the working season of 1912 hauling ore, before leasing it to another party confident in the mining district's freight and tourist business. The individuals began service in 1913 as the Argentine & Gray's Peak Railway Company, which revived activity at a few of the largest mines such as the Vidler Tunnel. These operations yielded ore intermittently for several years, but all mines were idle again by 1916. Waldorf was abandoned, and Rogers scaled back operations at the Santiago. With little demand for service, Rogers applied to the Interstate Commerce Commission (ICC) to abandon the railroad, but the U.S. Railroad Administration seized control in 1917. The Administration did so with all railroads in the nation as part of the federal government's World War I mobilization effort. When the Administration confirmed that no demand existed for the railroad, the ICC granted the application in 1918, and the line was dismantled the next year.⁴⁵⁸

While the Argentine Central was struggling, C&S held steady. Prices for silver, lead, and copper spiked during World War I, stimulating a wave of mining activity. An increase in freight traffic promised greater revenue for C&S, but the railroad did not realize the income. The U.S. Railroad Administration took control of C&S as well in 1917, reducing service and neglecting maintenance. The Administration paid C&S a royalty, but the amount did not offset lost income or operating expenses. When the Administration restored the railroad to C&S management in 1920, it left the system with compounded difficulties. C&S inherited a backlog of maintenance and unhappy customers and faced little hope of recouping its losses as the nation's economy slipped into a recession. Conditions would only grow worse the following year.⁴⁵⁹

Clear Creek Railroad System: Major Decline, 1921-1929

The Clear Creek County railroad system entered an irreversible decline in 1921 along with most Colorado carriers. A conspiracy of factors eroded the financial condition of C&S, sending the railroad into a downward spiral from which it never recovered. First, the nation descended into a postwar depression that stifled business, reduced consumption of goods, made loans difficult to secure, and, of special concern for C&S, greatly reduced tourism. Second, local tourists with disposable income preferred to travel by automobile instead of rail. Last and most important, Clear Creek County's mining industry collapsed. Exhaustion of all but the lowest grades of ore had placed the industry in a precarious position. In 1919, the industry produced \$91,000 in gold, already greatly reduced from the previous year, and \$400,000 in silver, which was still in demand due to World War I. Both figures were almost halved to \$49,000 in gold and \$240,000 in silver in 1920, with silver halved again the following year.⁴⁶⁰ The decline was abrupt and ruined the region as dozens of mines suspended, workers left to find jobs elsewhere, and dependent businesses closed.

The outcome was catastrophic for C&S in Clear Creek County. Passenger and freight demand fell to an all-time low with little hope of reversal. Management assessed the situation for a year and then pursued the only available course: reduction in service followed by divestment of assets. In 1920, C&S stopped running tourist express trains from Denver to Silver Plume, leaving those tourists willing to travel by rail only with the morning local. This further discouraged ridership, and as a result, C&S cut service to Silver Plume except for one train per day.

⁴⁵⁷ Abbott, 1977:99, 100; Griswold, et al., 1988:63, 70.

⁴⁵⁸ Abbott, 1977:100, 111, 113; Griswold, et al., 1988:63, 70; Hauck, 1979:106.

⁴⁵⁹ Hauck, 1979:108; Osterwald, 1991:99.

⁴⁶⁰ Henderson, 1926:109.

Reflecting the decline, passenger revenue dropped precipitously from around \$63,000 in 1923 down to \$35,000 by 1926.⁴⁶¹

In terms of assets, C&S began culling its oldest and most worn locomotives, scrapping some and selling others. The carrier had fifty locomotives around 1900, dispatched twelve during the late 1910s, and rid itself of another thirteen by 1924. Of the twenty-five remaining, C&S dedicated only three for passenger service and two for freight in Clear Creek County. Rolling stock was disposed of as well, and C&S retired many cars when they came in for repair instead of refurbishing them.⁴⁶² The entire Clear Creek County system operated at a loss, and by the mid-1920s, it became apparent to management that this was unlikely to change. Management sought additional cuts in an effort to save the system, finding little room except complete elimination of passenger service. In 1926, C&S applied to the Colorado Public Utilities Commission (PUC) to stop passenger service, resulting in protest from Clear Creek, Gilpin, and Jefferson counties. The PUC held a series of open hearings from December 1926 through January 1927. C&S explained how freight and passenger revenues had declined to a meager ten percent even in years when the economy was sound, primarily because of buses, trucks, and automobiles. Gilpin and Clear Creek county residents countered that suspension of freight service, vital to the little mining left, was next.⁴⁶³

In 1927, the PUC ruled a compromise for both sides. On one hand, the PUC allowed C&S to discontinue passenger-specific trains, with the last running to Georgetown on June 4, 1927. On the other hand, the PUC required mixed trains of freight cars with one or two passenger coaches. As business continued to decline during the late 1920s, C&S reduced its Clear Creek schedule to three trains per week. Within a short time, the Great Depression rendered even this abbreviated service a major drain for C&S, although the railroad became more important to the county than ever.

End of the Clear Creek Railroad System, 1930-1940

In 1929, financial institutions collapsed, commerce nearly ceased, capital evaporated, and thousands were thrown out of work. Prices for metals tumbled, and with them, the remainder of Clear Creek County's mining industry. As the depression deepened during the early 1930s, the demand for freight and passenger service in the county decreased to the point where management considered abandoning the entire system. Regardless, C&S continued running its mixed trains but was forced to find yet more ways to cut costs. In response, management reduced weekly trains from three to two, designating Georgetown as end-of-line. Regular traffic to Silver Plume was suspended, although when the handful of productive mines there stockpiled enough ore, C&S sent up a freight train to fetch the material. Silver Plume considered itself fortunate, because C&S abandoned its line from Black Hawk to Central City altogether in 1931.⁴⁶⁴

In 1933, President Roosevelt provided the county, its mining industry, and C&S a glimmer of hope. At that time, he instructed the Treasury to buy gold at inflated prices to stimulate gold mining. The following year, Roosevelt signed into law the Gold Reserve and Silver Purchase acts, which increased the prices of gold and silver. As expected, gold and silver mining across the West rebounded and experienced a measurable revival. Clear Creek County saw local interests reopen many of its former producers, fostering renewed demand for C&S freight service. The railroad restored thrice-weekly trains in 1935, directly supporting an

⁴⁶¹ Morgan, Gary. *The Georgetown Loop: Colorado's Scenic Wonder*. Fort Collins, CO: Centennial Publications, 1976, 26; Hauck, 1979:108.

⁴⁶² Hauck, 1979:154.

⁴⁶³ Griswold, et al., 1988:111; Hauck, 1979:109.

⁴⁶⁴ Hauck, 1979:174.

improvement in the regional economy during a time of great need. The amount of traffic, however, was still inadequate to offset the system's operating costs, and C&S management applied to the ICC in 1936 to abandon the Clear Creek system. Business interests responded loudly, correctly claiming that mining, and hence the economy, was completely dependent on the railroad for viability. The mining industry presented a sound argument that it was undergoing a measurable revival. The ICC held hearings and considered evidence for a year, before finally granting C&S permission to abandon the track from Idaho Springs to Silver Plume in 1937. Clear Creek County residents and businesses continued their protests, but a two-year extension was all they could secure.⁴⁶⁵

In January 1939 C&S suspended traffic beyond the Idaho Springs and dismantled the line, including the trestles and High Bridge once considered an engineering marvel. The ICC required C&S to provide service to Idaho Springs, now the end-of-line, on presumption that the station could handle the county's freight. As a result, the mining industry increasingly shipped ore and supplies by truck, strengthening C&S case for abandonment. In 1936, mining companies shipped 6,539 tons of ore and concentrates by rail and only 164 tons by truck to the smelters at Leadville. By comparison, they sent only 303 tons by rail and 9,810 by truck in 1940. With these numbers and internal figures, C&S had a relatively easy time convincing the ICC in 1940 to allow abandonment of the last section of the original CCRR track from Golden to Idaho Springs. The last train ran on May 4, 1940.⁴⁶⁶

TEN MILE CANYON AND BLUE RIVER RAILROAD SYSTEM, 1882-1937

The Blue River and Ten Mile drainage were routes for Summit County's only two railroads, significant during the period 1882 through 1937. The Denver & Rio Grande Railroad built the dead-end Dillon Branch from Leadville, down Ten Mile Creek, to Dillon in 1882. The branch was the first railroad in Summit County and had an impact similar to that in Clear Creek drainage. Concerned over competition from other railroads, the Denver & Rio Grande hastened to secure Summit County and position itself to push into northern Colorado ahead of Union Pacific. The branch went no further, however, because Denver & Rio Grande ran out of funds. The Denver, South Park & Pacific Railroad arrived in Dillon in 1883. That railroad's route, known as the High Line, curved from its South Park yards through the Blue River valley to Dillon, from there paralleling the Denver & Rio Grande to Leadville. The High Line was as much a function of railroad politics as an attempt to serve Summit County. Union Pacific bought the Denver, South Park & Pacific and built the High Line to out-manuever other railroads. The High Line became Union Pacific's sought-after route to Leadville, means for dominating Summit County, and a barrier discouraging other railroads from the region. Completion of the High Line multiplied the benefit to Summit County. When mining slowed in Summit County around 1907, the competing railroads agreed that business was insufficient to support both lines. The railroads cooperated in 1911, with Denver & Rio Grande forfeiting its Dillon Branch in exchange for a Denver, South Park & Pacific branch in Gunnison County. The High Line became Summit County's only railroad until the Great Depression forced its closure in 1937.

Ten Mile Creek and the Blue River valley were served by two mountain railroads that graded competing routes into Summit County (see Illustrationss A 5.10 and A 5.11, and Table 5.2). The Denver & Rio Grande Railroad arrived first in 1881 when it completed a line known as the Dillon Branch from Leadville to the hamlet of Dillon. The Denver & Rio Grande (D&RG)

⁴⁶⁵ Hauck, 1979:177.

⁴⁶⁶ Griswold, et al., 1988:39, 112; Hauck, 1979:177, 179; Morgan, 1976:26; Osterwald, 1991:106.

strategically planned the dead-end branch to capture the mining and logging traffic in Summit County, if not as a platform for expansion into northwestern Colorado. While D&RG reaped plenty of business in Summit County, it never pursued the latter goal. The Dillon Branch began in Leadville, ascended the Arkansas River headwaters, crossed north over Fremont Pass, and dropped into the Robinson Mining District and towns of Kokomo, Recen, and Robinson. From there, the branch descended Ten Mile Creek to Frisco, primarily on the valley's west side, although the bed crossed to the east for several short segments. The branch passed easterly through Frisco and followed the northwest side of Ten Mile Creek to Dillon on the Blue River.

The Denver, South Park & Pacific Railroad graded a second line through the area in 1883. DSP&P built its track as a component of a larger system aptly known as the High Line, with Dillon as hub. DSP&P built the High Line not only to compete with D&RG in Summit County, which it did very well, but also to serve as a main route from its yard in Como, South Park, to Leadville. The route crossed from South Park into Summit County over Boreas Pass, winding its way down into Breckenridge on the floor of Blue River valley. From there, the High Line traveled north along the Blue River to as Placer Junction, and Dickey's Junction by around 1901. At the station, one branch went west, passed through Frisco, and wrapped around Mount Royal into Ten Mile Creek valley. The line ascended the east side of Ten Mile Creek into the Robinson district, crossed Fremont Pass, and continued south to Leadville. At Dickey's Junction, another track continued north to a station in Dillon, veered southeast, and ascended the Snake River to the important logging camp of Keystone.

Today, more evidence of DSP&P line remains in Summit County than of D&RG. The High Line railbed from Dickey's Junction through Ten Mile valley is now a bike path. Segments from the junction south to Breckenridge are intact, but the junction, the site of Dillon, and the connecting grade are underneath Dillon Reservoir. In terms of D&RG's Dillon Branch, I-70 was built over most of the Ten Mile Creek grade (mile markers are unknown), residential construction obscured the segment in Frisco, and Dillon reservoir drowned the extension to Dillon. Both railroad lines were historically significant during their years of use.

Table 5.2: Ten Mile Canyon and Blue River Railroad System Data

Denver & Rio Grande Railroad (D&RG)	
Year Organized	1870
Total System Construction Timeframe	1870-1934
Construction of Dillon Branch:	1881 (Leadville to Wheeler); 1882 (Wheeler to Dillon)
Construction of Glenwood Extension:	1887 (Red Cliff to Glenwood Springs)
Construction of Dotsero Cutoff:	1933-1934
Operating Timeframe:	1870-Present
Operation of Dillon Branch:	1882-1911 (track dismantled in 1924)
Operation of Glenwood Extension:	1887-Present (Minturn to Dotsero closed in 1996)
Operation of Dotsero Extension:	1934-Present
Predecessors	None
Headquarters: Location	Denver
Traffic/Service: Type	Common carrier with transcontinental connections
Disposition	1920, merged into Denver & Rio Grande Western. 1988, purchased by Southern Pacific Railroad. 1996, merged into Union Pacific Railroad.

Denver, South Park & Pacific Railroad (DSP&P)	
Year Organized	1872
Total Line Construction Timeframe	1873-1884
Construction of High Line:	1882-1883 (Como to Dillon 1882), (Dillon to Leadville 1883)
Operating Timeframe	1873-1937
Predecessors	None
Headquarters Location	Denver
Traffic/Service Type	Common carrier emphasizing mining
Disposition	1889, reorganized as Denver, Leadville & Gunnison Railroad (DL&G). 1890, consolidated into Union Pacific, Denver & Gulf Railroad. 1898, consolidated into Colorado & Southern Railroad (C&S).

Denver & Rio Grande Railroad: Organized, 1870-1876

William Jackson Palmer was among a handful of entrepreneurs who envisioned railroad systems in Colorado long before the territory could support even a single line. While surveying a route for Kansas Pacific Railroad during the late 1860s, Palmer became acquainted with the terrain south of Denver and predicted the area was ripe for a railroad. He correctly forecast agriculture along the Front Range where water was available, and mining deeper in the mountains. Palmer understood that these industries would constitute a sound market for an appropriately planned railroad system. His ideal design involved a main line running up and down the piedmont area with branches extending west up the principal drainages and into the mountains.

In 1870, Palmer discussed the project's potential with William P. Mellen of New York, William A. Bell, W.H. Greenwood of Kansas Pacific, and attorney Samuel E. Brown. They agreed that such a railroad could be highly successful in the long term but difficult to fund and construct. Palmer's advisors recommended narrow-gauge instead of standard-gauge because it cost less and could negotiate mountain terrain. Within a short time, the capitalists formalized the venture as the Denver & Rio Grande Railroad (D&RG) and obtained a charter to grade lines along most natural corridors in southern Colorado. One main line went south from Denver to Texas, another crossed over La Veta Pass into the San Luis Valley, and a third ascended into the central mountains along the Arkansas River. Feeder branches radiated off these trunks to areas with high potential for mining. The new board of directors consisted of Palmer, Mellen, Alexander C. Hunt, and Captain Howard Schuyler of Denver, and Robert H. Lamborn, who served in the Civil War with Palmer. All aggressively sold stock to fund construction, which began within the year.⁴⁶⁷

The first segment of Palmer's piedmont artery, from Denver south to Colorado Springs, was finished in 1871, and the second, south to Pueblo, the next year. In what became standard D&RG practice, Palmer secured financial incentives and free land in exchange for a commitment to provide service. Palmer next turned his attention toward the first westward mountain extension, to ascend from Pueblo to Cañon City and up the Arkansas River. In 1872, Palmer contracted with the Central Colorado Improvement Company to grade a thirty mile spur from Pueblo to the Labran coal mines near Florence. D&RG, however, lacked funds, so the firm retained the line as the Cañon Coal Railway Company but relied on D&RG for service. Due to financial difficulties, D&RG was unable to push the line farther to Cañon City despite promises

⁴⁶⁷ Athearn, Robert G. *Rebel of the Rockies: The Denver & Rio Grande Western Railroad*. New Haven, CT: Yale University Press, 1962, 15; LeMassena, Robert A. *Colorado's Mountain Railroads*. Denver, CO: Sundance Books, 1984, 121; Stone, Wilbur Fisk. *History of Colorado, Vol. I*. Chicago, IL: S.J. Clarke Publishing Co., 1918, 349.

otherwise. Repeating the Pueblo strategy, D&RG requested bonds, some construction labor, and land as incentive to finish the line. The townsfolk balked at first but relented when D&RG suggested bypassing Cañon City on its way up the river. Central Colorado Improvement then finished the line to Cañon City in 1874, and D&RG paid its outstanding debts and assumed all trackage built to date. With its piedmont and Cañon City lines finished, D&RG was now positioned to pursue its master plan.⁴⁶⁸

D&RG: the Push to Leadville, 1877-1880

In 1876, placer mine operators William H. Stevens and Alvinus B. Wood discovered rich deposits of silver in California Gulch, high in the upper Arkansas River valley, and began development. During the next year, word of the find incited a rush to what became Leadville. Palmer paid close attention because it occurred in D&RG's area of interest and confirmed his predictions of mining in the mountains. Through reports and a personal visit, Palmer realized that the silver deposits were more extensive than initially suspected and would ultimately support a significant mining industry. Palmer wanted D&RG to be the first railroad into the mining district to gain a competitive advantage. The Atchison, Topeka & Santa Fe Railroad (AT&SF) was also aware of Leadville's potential and was already present in southern Colorado. Both railroads converged on Cañon City in 1877 and began a battle for Royal Gorge, the narrow and rock-walled gateway into the upper valley. Physical conditions presented by the gorge brought the struggle into open conflict. The gorge was barely wide enough for one rail grade. At first, the rivals tried to sabotage each other, took strategic ground by force, and harassed track gangs. Construction stalled as AT&SF and D&RG lawyers did battle in court. AT&SF claimed that its subsidiary, the Cañon City & San Juan Railroad, had rights to the gorge, but Palmer countered that his original 1870 charter gave him senior rights. In 1878, the Colorado Supreme Court decided the case, allowing both railroads to build at the same time without obstructing each other. AT&SF had primary right where there was enough room for only one track, but had to allow D&RG its use. Palmer was unsatisfied because the decision meant that AT&SF could still grade to Leadville, and so sued for an injunction on other grounds.⁴⁶⁹

D&RG was unable to devote full attention to the battle because of major problems on other fronts. In his zeal to expand D&RG, Palmer financially overextended the railroad and was unable to pay interest on its debts. At the same time, AT&SF was unrelenting not only in its push for Leadville, but also domination over all of southern Colorado. As the Union Pacific Railroad did in northern Colorado, AT&SF attempted to wrest control over mountain railroads as feeders for its transcontinental system and, where unsuccessful, build its own lines into the mountains. AT&SF wanted, in particular, the high volume of Leadville traffic and demanded acquiescence from D&RG.

When Palmer balked, AT&SF directors got their way by might. AT&SF threatened to draw off D&RG traffic by building tracks parallel to most of its existing lines. Squeezed between mounting debt and permanent loss of traffic, Palmer agreed to lease D&RG to AT&SF for thirty years on certain conditions. AT&SF could not build lines that competed with existing D&RG routes, and both railroads had to drop their lawsuits. Secretly, Palmer was already seeking a way out of the lease and maintained a personal lawsuit against AT&SF right through the gorge, which was pending in the United States Supreme Court.⁴⁷⁰

⁴⁶⁸ LeMassena, Robert A. *Rio Grande ... to the Pacific!* Denver, CO: Sundance Books, 1974, 15; Athearn, 1962:23; LeMassena, 1984:121; Stone, 1918, V.1:350.

⁴⁶⁹ Athearn, 1962:61.

⁴⁷⁰ Athearn, 1962:69; LeMassena, 1984:123; Stone, 1918, V.1:356.

In 1879, Palmer was rewarded for his patience and savvy. AT&SF resumed construction in the gorge and laid rails as far as Texas Creek when it received news that the Supreme Court found in favor of Palmer and upheld D&RG's senior right. AT&SF directors were unhappy but took solace in the fact that they still controlled D&RG. Then, Palmer found the indiscretion that he needed to dissolve the lease. Palmer discovered that AT&SF was quietly directing funds through the eastern banking house of Kidder, Peabody & Company to the Denver, South Park & Pacific Railroad (DSP&P), which was also pushing to Leadville from Denver. Palmer immediately filed a lawsuit claiming that DSP&P was a competing line, and by providing funds, AT&SF had violated the terms of the lease. Further, Palmer established that the violation was willful because an AT&SF vice-president was on the board of Kidder and knew his position to be a conflict of interest. The court found in favor of Palmer and cancelled the lease, and in case AT&SF proved recalcitrant, Palmer rallied together sheriffs and loyal employees to take the railroad back by force of arms.⁴⁷¹

Palmer and associates were back in command of D&RG by the end of 1879 with primary rights to Leadville but still faced a financial crisis. They were also squeezed by the hostile AT&SF to the south and Jay Gould's growing Union Pacific and Kansas Pacific empire to the north. Gould approached Palmer with an offer that solved their principal problems. Gould considered AT&SF a bitter foe and saw D&RG as an ally against his greatest competitor. As with the Colorado Central in Clear Creek County, Gould also perceived D&RG as a feeder railroad for his Union Pacific and Kansas Pacific systems. Unlike the Colorado Central, Gould thought gaining control over D&RG was unlikely and so enticed its cooperation instead. Gould provided emergency funds in exchange for a small interest in the railroad and a trade agreement to the complete exclusion of AT&SF. When AT&SF protested, Gould gave the directors a sample of their own strategy and threatened to build a system that paralleled theirs. Palmer and partners readily accepted and enjoyed the political support for a short time.⁴⁷²

Gould felt that the political dealings and machinations between the railroads needed to be formalized for lasting peace. In 1880, officials from Union Pacific, Kansas Pacific, D&RG, and AT&SF met in Boston to hammer out the Tripartite Agreement, also known as the Treaty of Boston. The agreement partitioned the Rocky Mountain chain into market shares. AT&SF agreed to stay south and east of the Rio Grande River and could not venture north and west. D&RG could not build into New Mexico, reserved for AT&SF, nor into northern Colorado, which the Union Pacific claimed. This left the central mountains for D&RG.⁴⁷³

With fresh investment from eastern capitalists and Colorado now divided into market territories, Palmer and partners resumed their master plan to dominate the mountains. D&RG purchased, at cost, the unfinished grade that AT&SF had built in the Arkansas River valley. In August 1880, D&RG finally reached Leadville, well in advance of DSP&P, giving the railroad the competitive edge it sought and a platform for important extensions.⁴⁷⁴

In 1880, less than a year after the Treaty of Boston, the first crack appeared in the agreement. During the struggle between the railroads, Gould was quietly buying stock in both D&RG and DSP&P in hopes of controlling whichever one completed a track to Leadville. When Gould realized that control over D&RG was unlikely, he focused on DSP&P, acquiring both majority interest and an agreement with founder John Evans. When Palmer learned of this, he grew furious because Gould openly supported a competing system, which went against the

⁴⁷¹ Athearn, 1962:72, 75, 80; LeMassena, 1984:125; Osterwald, 1991:71; Poor, 1976:162; Stone, 1918, V.1:356.

⁴⁷² Athearn, 1962:85; LeMassena, 1984:125; Poor, 1976:163; Stone, 1918, V.1:358.

⁴⁷³ Chappell, 1974:44; Osterwald, 1991:72; Poor, 1976:189.

⁴⁷⁴ Beebe, Lucius and Clegg, Charles. *Rio Grande: Mainline of the Rockies*. Berkeley, CA: Howell-North, 1962, 149; Athearn, 1962:98, 100; Osterwald, 1991:74; Poor, 1976:184; Stone, 1918, V.1:359.

Treaty of Boston. Palmer responded with a complicated strategy. He continued to uphold the exclusive trade agreement with Union Pacific and Kansas Pacific, but entered into an aggressive battle against Gould's DSP&P in the mountains. D&RG ultimately proved victorious through a period of unprecedented expansion, but not without repercussions, as will be discussed in the section below on the Eagle and Colorado River drainages.

D&RG: Builds the Dillon Branch, 1881

When D&RG reached Leadville, Palmer and associates celebrated only briefly. They correctly feared that Gould would develop DSP&P into a formidable mountain system and usurp their territory. Thus, Palmer initiated a period of rapid expansion to weave D&RG throughout the mountains advance of DSP&P. The Leadville terminus and Arkansas River valley trunk line served as platforms for three strategic extensions started in 1881. One, built in a winning race against DSP&P, crossed over the Collegiate Mountains to Gunnison. The other was a line from Leadville over Tennessee Pass and down the Eagle River to the new mining district of Red Cliff. The last went north from Leadville, up Fremont Pass, down into Ten Mile valley, and northeast to Dillon on the Blue River in Summit County.

The last extension, known as the Dillon Branch, served several strategic purposes. The first was to capture the Robinson Mining District, which boomed shortly after Leadville. The district, at the head of Ten Mile Creek on the north side of Fremont Pass, featured mines scattered around the towns of Robinson, Kokomo, and Recen. The branch's second purpose was to establish a station on the Blue River to test that area's market, including Frisco, Breckenridge, and satellite mining camps. The last function was as a railhead for expansion into northern Colorado, Gould's territory.

Although construction on the Dillon Branch began in 1881, Palmer had already secured the route through a subsidiary company. Palmer, adept at railroad strategy, repeatedly used this railroad charter loophole to avoid lawsuits. D&RG's original charter limited that railroad to routes outlined at its time of organization, leaving routes defined afterward open to legal contest. Thus, Palmer claimed desirable routes through on paper only railroads and sold them to D&RG. The Leadville, Ten Mile & Breckenridge Railway was one such subsidiary, both organized and sold to D&RG in 1880 with the Dillon Branch in its charter.⁴⁷⁵

During 1881, construction crews completed track over the pass through the Robinson district to Wheeler, presently Copper Mountain Ski Resort. Wheeler, a small settlement on the valley floor, grew in response to several mines, sawmills, and road traffic to Leadville. When D&RG began surveying the Dillon Branch, residents realized that the line would increase the hamlet's importance. They applied for and received a post office in 1880, in advance of the railroad. When D&RG arrived in 1881, it designated Wheeler as a coal and water stop, provided a station, and erected a construction camp.⁴⁷⁶

When the working season of 1882 opened, D&RG finished the branch down the west side of Ten Mile Canyon to Frisco and along the creek to Dillon. D&RG stopped at Dillon and did not grade north or south up the Blue to Breckenridge as initially planned. Although Breckenridge was the major town in the area, DSP&P was already on the way over from South Park, and once it established service, it would be able to offer lower freight and passenger rates and shorter travel time than D&RG. Breckenridge was one of the few areas of contest where

⁴⁷⁵ Digerness, 1978:35; Poor, 1976:242.

⁴⁷⁶ Bauer, et al., 1990:151; Digerness, 1978:38; Osterwald, 1991:74.

D&RG was unable to compete against DSP&P. Until DSP&P reached Breckenridge, however, D&RG enjoyed a brief monopoly in Summit County.⁴⁷⁷

In 1882, DSP&P arrived and outmatched D&RG. DSP&P graded a track from Breckenridge to Dillon, a spur to the sawmills at Keystone, and a main line up Ten Mile Canyon to Leadville. Because DSP&P had direct access to Denver, shorter travel times, and stations in Breckenridge and along the Blue River, it quickly dominated Summit County. D&RG quietly conceded defeat understanding that beyond the Robinson district, the Dillon Branch was secondary among businesses and riders. Regardless, the Dillon Branch remained important to the development of the Blue River drainage. By competing for freight and passengers, D&RG and DSP&P kept their rates low, which changed the course of industry and settlement in the area. The two railroads provided an all-season link with the outside world, reduced high freight rates, and facilitated rapid movement of people and goods. The costs of mining and logging fell, stimulating a countywide boom among these two industries. Lumber companies were able to ship their products to markets in Denver and Leadville. Mining companies profitably extracted lower grades of ore in higher tonnages from deep workings, sending it to smelters in Denver and Leadville. The railroad also made the region accessible to capitalists, who were more likely to invest after personal examination. The reduced freight rates in turn benefited the county's residents by lowering the cost of living and improving the quality of daily life. By providing regular contact with the outside world, the railroads also served as a conduit for culture. Overall, Summit County, its towns, and mining and logging industries grew quickly during the early 1880s as a result of the railroads.

D&RG: Operates the Dillon Branch, 1883-1911

D&RG maintained its relationship with the Ten Mile and Blue River area for around twenty-five years, although the Dillon Branch was profitable only intermittently. The Ten Mile Mining District boomed during the early 1880s but slowed by the middle of the decade with no industry to take its place. The latter half of the decade became difficult for the Dillon Branch. This changed during the early 1890s when logging and mining revived, although the branch was unprofitable again following the Silver Crash of 1893. Logging and mining revived again in the late 1890s, peaked by 1910, and then permanently declined. The ore and old-growth trees were nearly exhausted and insufficient to sustain mining and logging on meaningful levels. As a result, the general economy contracted to the point where it could not support two railroads.

Because DSP&P's (now C&S) Summit County line continued a higher volume of traffic, it remained the dominant railroad. D&RG reduced service to Dillon and found that, by the end of the first decade of the twentieth century, the cost of clearing snow and maintaining service exceeded income. D&RG directors determined to abandon the branch, but not without extracting a tribute from DSP&P. Officials from the two railroads met and agreed to exchange territories. D&RG maintained a strong presence in Gunnison County and coveted a particular dead-end line owned by C&S. At the same time, C&S was eager for D&RG to relinquish Dillon. Thus, the two railroads exchanged lines, the Gunnison County spur for the Dillon Branch, benefiting both organizations. D&RG still owned the Dillon Branch but cancelled service, leaving C&S as the only carrier between Breckenridge and Leadville. Few residents or businesses missed the infrequent D&RG trains, and the track was dismantled in 1924.⁴⁷⁸

⁴⁷⁷ Digerness, 1978:38; LeMassena, 1974:41; LeMassena, 1984:127; Osterwald, 1991:74; Poor, 1976:242; Stone, 1918, V.1:360.

⁴⁷⁸ Klinger, Tom and Klinger, Denise. *C&S High Line Memories, and then Some*. Lakewood, CO: Tom Klinger, 2004 141; Atheam, 1962:214; LeMassena, 1974:125, 139; LeMassena, 1984:163.

Denver, South Park & Pacific Railroad: Organized, 1872-1877

During the late 1860s, Denver's elite struggled with W.A.H. Loveland and mining capitalists over which city would become Colorado's railroad hub. John Evans fought for Denver, while Loveland promoted Golden. Both parties succeeded to a degree. Evans connected the Denver Pacific Railroad with UPRR transcontinental line in Wyoming, while Loveland established the Colorado Central Railroad. The advantage that Loveland possessed was access to valuable mining traffic in Clear Creek and Gilpin counties. Because Golden was gateway to these counties, it was poised to become a hub of both commerce and transportation. Denver Pacific, by contrast, served no industries of significance, leaving Denver merely as a freight exchange center.

Evans understood that to make Denver an important hub, they too had to build a railroad into the mountains, where natural resources lay. They took action in 1872, organizing the Denver, South Park & Pacific Railway. The principals were prominent Denverites including Governor Evans, Joseph E. Bates, Walter Cheesman, Henry Crow, Bela M. Hughes, Charles B. Kountz, David Moffat, and F.Z. Solomon. Evans and associates planned a route up the South Platte River to South Park, down into the Arkansas River Valley, and southwest to the San Juan Mountains. When Loveland's Colorado Central began grading to Georgetown, Evans chartered the Denver, Georgetown & Utah Railroad as competition. The paper railroad never broke ground, but Evans wanted to include its route and capital in the other company. Thus, the investors combined assets as the Denver, South Park & Pacific Railroad (DSP&P) in 1873.⁴⁷⁹

After obtaining bonds, the Evans group established the contracting firm Denver Railway Association in 1873 and began construction. The company laid rails as far as Morrison before stopping due to the financial panic of 1873. For several years, the fledgling railroad sustained itself on passengers, building stone, fence posts, lime, and lumber. In 1876, public outcry over the stalled DSP&P and the public funds it received moved Evans and partners into action. They pushed the railroad well up the South Platte canyon but ran out of capital, established a railhead, and stopped again.⁴⁸⁰

DSP&P: Builds to Leadville, 1877-1880

Although DSP&P had not yet reached South Park, ridership and one-way freight rose suddenly in 1877, with most traffic disembarking for the new mining camp of Leadville. Like William Jackson Palmer of D&RG, Evans forecast that Leadville was in the early stages of a sustained boom that would eventually generate high volumes of traffic. He and partners worked quickly to resume construction, modifying their South Park objective. Originally, DSP&P planned a hub in South Park with extensions radiating outward to Fairplay, surrounding ranches, and mining districts in the Mosquito Mountains. With Leadville now demanding attention, South Park itself became a secondary priority and Evans opted for the shortest route across the broad valley. Evans was well aware that Palmer's D&RG was racing toward Leadville, commanded the best avenue up the river valley, and was slightly in the lead.

Construction resumed in 1878, and even though DSP&P had a long way to go, the constantly moving railhead saw high volumes of traffic bound for the new camp. During 1879, construction crews pushed across South Park and down Trout Creek to the Arkansas River. They also established a yard at Como, primarily because its coal beds provided locomotive fuel.

⁴⁷⁹ Beebe and Clegg, 1958:124; Chappell, 1974:11; LeMassena, 1984:213; Osterwald, 1991:66; Poor, 1976:113, 117; Stone, 1918, V.1:365.

⁴⁸⁰ Chappell, 1974:13, 20, 25; LeMassena, 1984:213; Osterwald, 1991:66; Poor, 1976:124, 127, 131, 144.

Around this time, DSP&P became caught up in the political intrigue that surrounded D&RG, UPRR, Kansas Pacific, and AT&SF. Jay Gould, owner of UPRR and Kansas Pacific, fought bitter competitor AT&SF for domination of Colorado, cooperating with D&RG to do so. Gould's ultimate goal was to acquire control over the mountain railroads as feeders for his UPRR and Kansas Pacific transcontinental system. Above all, Gould wanted to capture the Leadville market and any railroad that served the mining city. Gould knew that D&RG's Arkansas Valley route to Leadville, while unfinished, was as good as built, but remained unable to acquire D&RG. The best he could do was secure a temporary operating agreement. Thus, Gould turned to DSP&P as his next best option in 1879, grooming Evans and partners for their cooperation while quietly buying stock in the railroad.⁴⁸¹

When DSP&P reached the Arkansas River valley, Evans assessed how best to carry out the railroad's long-term plans. He simultaneously wanted access to Leadville and to continue southwest over the Collegiate Range to Gunnison. D&RG already possessed the best route up the Arkansas River to Leadville, and Evans saw a second line as a costly waste of capital. Thus, he and Gould approached D&RG with a deal. If D&RG shared its track from Buena Vista to Leadville, then DSP&P would allow D&RG to use its line from Buena Vista to Gunnison, with the income from both lines equally divided. Evans was relieved from building a second track to Leadville, D&RG could access the Gunnison area, and Gould would shut out AT&SF through the alliance. Although no joint rails had been laid yet, both railroads signed the Joint Operating Agreement of 1879. In 1880, DSP&P graded north from Trout Creek to Buena Vista and turned west into the Collegiate Mountains, while D&RG finished its line to Leadville. Both railroads immediately instituted service and enjoyed heavy traffic.⁴⁸²

In 1880, Gould, D&RG, and AT&SF negotiated the Treaty of Boston, dividing Colorado into market shares. AT&SF was largely shut out of Colorado, D&RG was allotted the state's central portion, and Gould's UPRR agreed to Clear Creek County and points north. When the treaty was not even one year old, Gould destabilized the relationship by purchasing DSP&P and immediately selling it to UPRR. In so doing, UPRR established a direct presence in the territory specifically allotted to D&RG, which violated the treaty and enraged Palmer. Evans and associates profited handsomely, just as Gould received a high price from UPRR, which operated DSP&P as the South Park Division.⁴⁸³

With the treaty violated and the relationship between UPRR and D&RG damaged, the Joint Operating Agreement began to fall apart as neither railroad wanted to depend on each other's tracks. Palmer was the first to move away from the agreement by announcing plans to race DSP&P for Gunnison and usurp the territory. UPRR then withheld its payments for the shared track to Leadville. When UPRR assumed control over DSP&P in 1881, it appointed E.P. Vining as manager, and he knew little of the railroad's specific needs, did not listen to the advice of Evans and partners, and generally mismanaged the railroad. Worst of all, Vining raised freight rates so high that business went to D&RG. Thus, UPRR felt that it owed D&RG proportionately less for the shared track, and D&RG responded with a lawsuit. UPRR realized that it was dependent on D&RG through the Joint Operating Agreement for access to Leadville, and it was only a matter of time before the agreement was lapsed.⁴⁸⁴

⁴⁸¹ Osterwald, 1991:71; Poor, 1976:163, 190.

⁴⁸² Chappell, 1974:40-41; Digerness, 1978:29; Osterwald, 1991:71; Poor, 1976:173; Stone, 1918, V.1:366.

⁴⁸³ Beebe and Clegg, 1958:125; Chappell, 1974:48; Osterwald, 1991:74; Poor, 1976:198.

⁴⁸⁴ Osterwald, 1991:11 Poor, 1976:238.

DSP&P: Builds the High Line, 1881-1884

John Evans and DSP&P engineers Leonard Eicholtz and James A. Evans offered a solution to the problem of Leadville access. During the initial push for Leadville in 1878, they established the Denver, South Park & Ten Mile Railroad Company and claimed an alternate route through Summit County. The proposed line went from South Park to Breckenridge, Dillon, Ten Mile canyon, Fremont Pass, and Leadville. Evans intended to grade to Summit County at some point, but shelved the route with the D&RG agreement. Now that DSP&P required its own line to Leadville, the proposed route was revived. In 1881, Eicholtz and James Evans began construction on what was known as the High Line. Track crews spiked rails to Boreas Pass by spring while workers pushed the bed to Breckenridge and Dillon. In 1882, trains finally reached Breckenridge first and Dillon second, while DSP&P built an extension from Dillon southeast up the Snake River to the large sawmills at Keystone. At Dillon, DSP&P established a station and joined its rails with those of D&RG in the unlikely event that cars would be switched between the carriers (see Illustration A 5.12).⁴⁸⁵

After DSP&P established its railhead at Dillon in 1882, it hesitated. As long as D&RG continued sharing its Arkansas Valley line, DSP&P directors saw no need to assume the high cost of finishing the High Line to Leadville. However, D&RG sued when UPRR withheld payment again for the shared track, threatening Leadville access. DSP&P directors resumed construction in response. In 1883, James Evans and P.F. Barr surveyed a right-of-way from the Dillon track through the south side of Frisco, up Ten Mile Canyon, and into the Robinson district. The junction where the Leadville extension branched off the Dillon track was named Placer Junction, and received a water tank for locomotives, depot for freight and passengers, and rest house for train crews. Evans and Barr had great difficulty finding a viable path for the grade because D&RG had already built its Dillon Branch on the canyon floor. They were thus limited to the canyon's east side, which offered little room and presented obstacles. C.W. Collins & Company and Carlisle & Corregan were awarded contracts to build the line, paying trackmen \$2.25 per day and rockmen \$2.50 per day. Labor was difficult to find, so UPRR advertised out of state and drew twice as many workers as were actually needed. The contractors hired only half of those who arrived and turned the rest away, who had to find work in the dead of winter.⁴⁸⁶

A succession of problems delayed construction of the High Line in Ten Mile canyon. Not only did DSP&P contend with difficult weather and physical conditions, but D&RG did everything in its power to stymie progress. D&RG applied for injunctions against DSP&P over right-of-way infringements and the impacts of construction. When DSP&P arrived at Kokomo, it became further entangled with D&RG over a need to cross hostile tracks. Ultimately, the courts favored DSP&P in most cases, allowing the railroad to reach Leadville in 1884. The High Line was complete at the substantial cost of \$1,134,399, or \$18,000 per mile. And yet, unusually heavy snowpack on Boreas Pass prevented DSP&P from inaugurating service until September 1884, which required UPRR to continue the Joint Operating Agreement and mollify D&RG with back-payments to keep the Arkansas Valley line open.⁴⁸⁷

⁴⁸⁵ Chappell, 1974:54; Digerness, 1978:38; LeMassena, 1984:213; Osterwald, 1991:77; Poor, 1976:242, 248.

⁴⁸⁶ Chappell, 1974:56, 60; LeMassena, 1984:213; Osterwald, 1991:12; Poor, 1976:249, 252.

⁴⁸⁷ Beebe and Clegg, 1958:125; Chappell, 1974:61; Digerness, 1978:129; Osterwald, 1991:79; Poor, 1976:257, 259, 265.

DSP&P: Operates the High Line, 1885-1893

DSP&P operated the High Line regularly through the decade's end, but at a loss. While Leadville provided DSP&P with consistent traffic, customers awarded much of their business to D&RG because of high freight rates imposed by UPRR. In addition, the route traversed one of the most rugged portions of the Rocky Mountains and crossed two passes with elevations above treeline, which consumed an alarming fifty-one percent of total revenues to keep open. Ten Mile canyon, the worst section, was regularly blocked by avalanches. And yet, UPRR accepted the losses because the amount of traffic that DSP&P shunted over to UPRR transcontinental line exceeded the deficit. Some of the traffic was ore shipped to the Omaha & Grant Smelter near Denver, in which UPRR president Charles F. Adams owned a significant share⁴⁸⁸

By 1889, DSP&P began defaulting on its loans and bond payments, and when creditors grew impatient, UPRR allowed DSP&P to go bankrupt. The bondholders forced DSP&P to be sold at auction to recover their loans, and UPRR bought it back to reorganize as the Denver, Leadville & Gunnison (DL&G), named after the principal points of service.⁴⁸⁹

As discussed above regarding the Colorado Central Railroad, UPRR officials consolidated their Colorado subsidiaries under the Union Pacific, Denver & Gulf Railway in 1890 to improve efficiency, keep troubled railroads off UPRR books, and protect profitable lines. The separate UPRR holding company now managed the Clear Creek County railroads, DL&G, and Denver, Texas & Gulf Railroad as one system, but allowed each its separate identity. From this point until the High Line closed, DL&G shared a parallel history under the Colorado Central in ownership because they belonged to the same parent railroad. The specifics are covered above with the Colorado Central. An important watershed was the financial failure of UPRR due to the Silver Crash of 1893. Shortly after, receiver Frank Trumbull was given charge of the Union Pacific, Denver & Gulf because he was impartial but sensitive to the needs of Colorado railroads. The transfer ended UPRR control over DL&G, and Trumbull began the complicated task of restoring DL&G back to profitability. This proved to be exceedingly difficult because Colorado's mining industry, which DL&G depended on for income, completely collapsed due to the Silver Crash.

Denver, Leadville & Gunnison Railroad: Operates the High Line, 1894-1897

During the mid-1890s, the financial panic caused by the Silver Crash of 1893 pushed the nation into economic depression. Colorado suffered because it relied largely on mining, which was nearly at a standstill, thus, dependent businesses and industries also failed. The financial outlook for DL&G and other mountain railroads was bleak, and Trumbull knew that a buyer would be long in coming in such a climate. And yet, DL&G derived some benefit from its receivership and delay in acquisition. Trumbull was an ideal manager because he was aggressive, practical, fiscally conservative, and understood the business of running a railroad in the mountains. He reduced wasteful operating costs, carried out long-deferred maintenance, improved service, added new locomotives and rolling stock, and solicited traffic. He replaced lost freight from metal mining with hay, ice, and coal from Crested Butte. Summit County continued as an important market as well because most mines around Breckenridge produced gold, which remained in demand. Thus, the High Line remained one of the railroad's key assets. Overall, Trumbull's program boosted DL&G's image and increased income, which was difficult

⁴⁸⁸ Chappell, 1974:71; Klinger and Klinger, 2004:155; Poor, 1976:278, 312.

⁴⁸⁹ Chappell, 1974:68, 71; Digerness, 1978:50; LeMassena, 1984:215; Osterwald, 1991:81; Poor, 1976:280; Stone, 1918, V.1:366.

to achieve in the climate of the depression.⁴⁹⁰ By the late 1890s, conditions were right for DL&G's return to private ownership. Trumbull successfully reversed the railroad from loss to profit, while the national economy recovered enough to foster confidence among investors. Trumbull put DL&G and the other railroads under the Union Pacific, Denver & Gulf up for auction.

Colorado & Southern Railroad: Operates the High Line, 1898-1920

In 1898, Henry Budge and other Union Pacific, Denver & Gulf bondholders bought the collection of Colorado railroads, including DL&G, reorganizing them as the Colorado & Southern (C&S). Trumbull was president and manager and Grenville M. Dodge and Oliver Ames, formerly of UPRR, were on the board of directors. At first, Budge and associates wanted to sever and dispose of DL&G because of its extreme operating costs. Dodge, however, convinced them otherwise, and Trumbull continued the railroad's profitability.

During the late 1890s, Colorado's mining industry revived, and Leadville and Summit County in particular boomed. Trumbull knew that DL&G had to compete against D&RG, which was well entrenched, which meant providing excellent service while operating efficiently. Thus, he began improving the High Line in 1901, especially in Summit County, to keep up with the increase in traffic. Placer Junction, renamed Dickey Junction, received a coal dock in 1902, an engine house the following year, and a rotary snowplow to keep tracks clear in winter. In Ten Mile canyon, sidings were built for the King Solomon and other mines, while the station of Curtin was established at the Mary Verna and North American mines (see Illustration A 5.13).⁴⁹¹

In 1908, C&S underwent major changes. The Burlington & Quincy Railroad purchased C&S, and Trumbull left. Without him, the entire system declined. The new directors, unappreciative of DL&G because of its high maintenance costs and limited business, attempted to close the branch. Summit County residents and businesses began a struggle with C&S. When traffic on the High Line became light in 1908 due to the effects of the 1907 financial panic, C&S suspended service on grounds that the line incurred excessive deficits. Trains resumed in 1909, but the directors tried to permanently close the track in 1910, forcing the Breckenridge Chamber of Commerce to obtain a court order reinstating operations. C&S, however, drastically cut the schedule. In 1911, D&RG forfeited its Dillon Branch to C&S, which now held a monopoly on all trains between Breckenridge and Leadville. Despite an increase in traffic, the High Line remained a financial liability, and C&S filed an application with the ICC in 1915 to end service. The application was denied, requiring C&S to subsidize operations with revenue from other portions of its Colorado system.⁴⁹²

In 1917, C&S received temporary relief from the drain imposed by the entire DL&G system. The U.S. Railroad Administration assumed control over the nation's railroads, including C&S, as part of its World War I mobilization policy. The Administration operated C&S for three years, during which the mining industries in Leadville and Summit County enjoyed a major revival, providing the railroad with business. When the Administration returned DL&G to C&S in 1920, however, revival and associated traffic ended, leaving the High Line in debt again. C&S desperately wanted to abandon the branch, but because it was Summit County's only railroad, the ICC would not support closure. As mining in Leadville and Summit County abruptly declined, the economic equation of the High Line grew even more imbalanced.

⁴⁹⁰ Chappell, 1974:73; Digerness, 1978:56; Hauck, 1979:103.

⁴⁹¹ Digerness, 1978:119; Klinger and Klinger, 2004:141; Poor, 1976:297.

⁴⁹² Chappell, 1974:73; Osterwald, 1991:98; Poor, 1976:394.

End of DSP&P High Line, 1921-1938

The entire DL&G system struggled and demand for service on the High Line was minimal during the 1920s. Almost no mining or logging on a commercial scale occurred in Summit County, and the few mining companies in Leadville shipped much of their ore via Denver and Rio Grande Western (D&RGW). In addition, automobiles and trucks diverted increasing business away from C&S. However, C&S was mandated to operate the High Line as Summit County's all-season link and only track in operation between Leadville and Breckenridge. C&S patiently bided its time until traffic was so light that even the ICC had to admit that the High Line had outlived its usefulness. In 1928, the opportunity to abandon the entire DL&G system materialized for C&S. Denver proposed damming the South Platte River in Waterton Canyon, which would have submerged DL&G's only line between Denver and the rest of the system in the mountains. C&S immediately embraced the dam because severing the main line justified abandoning the rest of the system. Reciprocally, Denver supported C&S's desire to close DL&G because the city could not build the dam as long as the track along the South Platte was viable. Thus, C&S applied to the ICC to abandon the entire system with the backing of Denver, meeting with strong protests from business interests in Park and Summit counties. As with the Colorado Central, C&S suffered a position where local interests insisted on service, but were unwilling to discourage the use of trucks to provide enough business.⁴⁹³

The ICC entertained hearings for almost two years before rendering its decision in 1930. The panel understood the importance of the dam and high losses sustained by C&S and agreed to abandonment on one condition. C&S had to wait a three-year period while finding another entity to run DL&G. C&S was not adamant about scrapping the railroad, instead merely wanting to dispose of the financial liability. As the Great Depression deepened during the early 1930s, C&S grew desperate to be rid of the system and tried giving it away, complete with locomotives and rolling stock. The offer attracted two parties. Victor A. Miller, receiver of Rio Grande Southern Railroad, thought the system could be kept open if rail buses were substituted for all traffic except occasional freight trains. Miller and C&S began negotiations, with Miller organizing Denver, Leadville & Alma Railroad in 1932 to take over the system. Shortly after, W.C. Johnstone made his own proposal to run the railroad under the Denver Intermountain & Summit Railway Company. Sadly, C&S turned down both Miller and Johnstone because the directors felt neither party had the resources to operate the line through the winter as required by the ICC. If Miller or Johnstone failed, C&S would have to repossess the railroad.⁴⁹⁴

When the waiting period expired at the end of 1933, C&S was no longer as eager to give up DL&G. The economy, and gold mining in particular, showed signs of a minor recovery due to the Gold Reserve and Silver Purchase acts. For two years, C&S watched the effect that revival had on demand for service, which was ultimately not as substantial as forecast. Trucks and automobiles were largely to blame, and C&S gathered enough information to demonstrate that trucks hauled fifty percent of the ore, eighty percent of the general goods, and seventy-five percent of the hay in DL&G region. Armed with these statistics, C&S filed an application with the ICC in 1935 to suspend service. The ICC approved. C&S operated the entire DL&G railroad system for one more full year, ran the last train between Leadville and Breckenridge in 1937, and ended service between Breckenridge and Como in 1938. The High Line segment between Leadville and the Climax molybdenum mine on Fremont Pass was conveyed to D&RGW, while

⁴⁹³ Chappell, 1974:192.

⁴⁹⁴ Chappell, 1974:192; Poor, 1976:395.

the rest of the track was dismantled, Dickey Junction and the track north to Dillon were flooded in 1963 by Dillon Reservoir.⁴⁹⁵

EAGLE AND COLORADO RIVER VALLEY RAILROAD SYSTEM, 1886-1962

The Eagle and Colorado rivers in Eagle County were routes for two connecting railroad lines built by the Denver & Rio Grande. One descended the Eagle River from Leadville to Minturn and west to Dotsero at the confluence. The line continued westerly along the Colorado River through Glenwood Canyon to Glenwood Springs. Denver & Rio Grande graded down the valley in 1886 not because of the small market there, but rather as a route between more important points. The Denver & Rio Grande simultaneously used the valley in a race against a rival from Leadville to Aspen, and to keep Union Pacific out of the region. In 1888, Denver & Rio Grande broadened the line's function, at first as an artery capturing the Colorado River valley down to Grand Junction, followed by a segment in the only transcontinental route through the Rocky Mountains. The other track in the drainage ascended the Colorado River north from Dotsero before joining the Denver & Salt Lake Railroad. The Denver & Rio Grande built the Dotsero Cutoff in 1934 to link its mountain system with Denver, increase transcontinental traffic flowing through Colorado, hence boosting earnings. The Leadville line ceased operation in 1996, while the Dotsero Cutoff is still heavily used today as the only transcontinental route through Colorado. The Period of Significance spans 1886 through 1962, fifty years prior to production of this report.

D&RG Builds the Leadville to Glenwood Branch, 1881-1887

After D&RG finished its highly profitable and strategic trunk line up the Arkansas River valley to Leadville, the railroad enjoyed expansion during the early 1880s. At first, a race for supremacy in the mountains over rival DSP&P drove the growth, but as D&RG successfully graded lines deep into Gunnison County and northwest down the Eagle River from Leadville, Palmer realized that Utah was within reach. Palmer's aspirations did not end at the border. If D&RG could connect with a friendly railroad in Utah, then it could serve as a link on the only transcontinental route to cross the Rockies. Palmer planned to connect his system with UPRR in Ogden, Utah, and Denver.

Because no friendly railroad existed in eastern Utah, Palmer established one. In 1881, he and Utah investors organized the Sevier Valley Railway Company to lay claim to a route to Colorado, then sold the subsidiary to D&RGW, which they formed at the same time.⁴⁹⁶ D&RG and D&RGW began building toward each other in 1881, enjoying rapid progress across the flat deserts of canyon land. During 1882, D&RG pushed from Gunnison through the important cattle center of Cimarron to Montrose and then followed the San Miguel River down to Grand Junction. With the project almost complete, D&RG leased D&RGW for thirty years to ally the two railroads. In 1883, D&RG turned its construction crews west at Grand Junction to complete tracks to Green River, Utah, where the railroads joined and became one system. D&RG increased its value as a transcontinental link, although the route across the Rockies was elaborate and circuitous, and therefore painfully slow. This fact would figure prominently later.⁴⁹⁷

⁴⁹⁵ Chappell, 1974:194; Digerness, 1978:215; Klinger and Klinger, 2004:141, 142; Osterwald, 1991:98; Poor, 1976:399.

⁴⁹⁶ Athearn, 1962:115.

⁴⁹⁷ Athearn, 1962:115, 121; LeMassena, 1974:41; Osterwald, 1991:78; Stone, 1918, V.1:360.

During the period of extreme expansion, Palmer accrued far too much debt, outpaced actual demand for service, and neglected existing lines. D&RG was in poor condition physically and fiscally, again unable to pay even basic debts such as interest on construction bonds. Tired of the constant financial drain, lack of returns, and rampant expansion, principal investors forced Palmer to resign in 1883. He focused instead on D&RGW. Palmer's replacement proved to be worse for D&RG, however.⁴⁹⁸

The board of directors secured Frederick Lovejoy as president because he had thirty years with the Adams Express Company, but no experience running a railroad. In an attempt to stem the constant drain of capital, Lovejoy put an immediate end to expansion but lost the savings to mismanagement. He fired long-term employees sympathetic to Palmer, tried to cancel D&RGW lease, entered into legal squabbles with Palmer, and deferred maintenance on D&RG. The result was a loss in productivity, decline in service, and further deterioration of the railroad's physical state. Lovejoy also regularly missed payments on debts and failed to pay employees. Within a year, Lovejoy ran D&RG into bankruptcy, and in 1884, William S. Jackson was appointed receiver.⁴⁹⁹

Because D&RG was in a poor state and subject to suits by creditors, Jackson made little progress restoring the carrier to profitability. The bondholders were unwilling to wait longer for payment and foreclosed on their loans, which forced sale of D&RG at auction in 1886. They bought the railroad back, reorganized the company, and appointed Jackson president. Jackson and some board members also secured new investors in Europe. As receiver, Jackson pursued one principal improvement intended to increase the railroad's ability to draw transcontinental traffic and hence increase revenue. He began laying a third rail along the main lines to accommodate standard-gauge rolling stock. Up to this point, D&RG was strictly a narrow-gauge system, which was incompatible with the standard-gauge equipment used by transcontinental railroads.⁵⁰⁰

In 1885, events unfolded that brought the Red Cliff extension into prominence. Several years earlier, a group of Colorado Springs investors organized Colorado Midland Railroad to build a third route from Colorado Springs to Leadville, and west over the Sawatch Range to Aspen, which they correctly forecast would boom. They chose 1883 to begin because under conservative Lovejoy, D&RG was unlikely to build its own extension to Aspen and threaten their project. Colorado Midland directors underestimated the time required to reach the new mining city, which presented Jackson with a narrow window in which to compete.

Jackson was aware that loss of the lucrative Aspen market was only part of a larger problem that Colorado Midland posed to D&RG. He assumed that Colorado Midland would not stop at Aspen and was likely to continue down the Roaring Fork River valley to Glenwood Springs. From there, it would be natural for Colorado Midland to send branches east and west along the Colorado River, thereby securing the entire river drainage for itself. Further, Colorado Midland might even form an agreement with Union Pacific, drawing the railroad giant deeper into D&RG territory. This was unacceptable to Jackson, who recognized that D&RG had to push into the Colorado River valley first.

Jackson presented his case to the board of directors and insisted on funds, but they were unmoved. The board was hesitant because of the financial catastrophe caused by Palmer's aggressive expansion, and they wanted to incur no more debt. Risking the wrath of the board and the security of his own job, Jackson took action anyway in 1886. He ordered construction crews

⁴⁹⁸ Athearn, 1962:135; LeMassena, 1974:41; LeMassena, 1984:136.

⁴⁹⁹ Athearn, 1962:146; LeMassena, 1974:43; LeMassena, 1984:137; Osterwald, 1991:79; Stone, 1918, V.1:361.

⁵⁰⁰ Athearn, 1962:153; LeMassena, 1974:46; LeMassena, 1984:139.

to begin building a line to Aspen from the dead-end Red Cliff extension (see Illustration A 5.14). The route, surveyed earlier, descended the Eagle River to its confluence with the Colorado River, followed the latter waterway to Glenwood Springs, and ascended the Roaring Fork to Aspen. Jackson planned the track to be standard-gauge to accommodate the same equipment used elsewhere.⁵⁰¹

In 1887, David H. Moffat succeeded Jackson as president. Moffat came with great experience as one of the organizers of DSP&P, and had reaped a fortune from Leadville and other mining districts. Moffat fully agreed with Jackson's policy both toward Aspen and converting D&RG main lines to standard-gauge. Under Moffat, D&RG entered into a heated race with Colorado Midland and poured its resources into completing a track down the Colorado River. In 1887, D&RG reached Glenwood Springs and turned south up the Roaring Fork to Aspen. Special incentives were offered to construction workers, which proved to be an effective investment because D&RG finished its Aspen line in October, months ahead of Colorado Midland. As with the expansions under Palmer, by arriving first, D&RG captured the most lucrative freight contracts.

The Leadville to Glenwood Springs and Aspen segments were immediate successes. Aspen provided D&RG with plenty of freight and passenger traffic, and railroad access allowed Glenwood Springs to grow into a thriving tourist resort, which drew additional passengers. All trains went through Leadville to Red Cliff and down the new extension along the Eagle River to Minturn (see Illustration A 5.15). D&RG established Minturn as a construction camp in 1887, and when the tracks were finished, the village was designated a coal and water stop. Community organizers secured a post office in 1889 under the name of Minturn in honor of Robert B. Minturn, a D&RG director. From Minturn, the Glenwood extension went through another coal and water stop, known as Dotsero, at the confluence of the Eagle and Colorado rivers. The name was a modification of Dot Zero, the starting point for a D&RG survey along the Colorado River. Local residents convinced the Post Office Department to grant them a post office in 1883, well in advance of the settlement's role as a railroad stop.⁵⁰²

D&RG Builds the Grand Junction Extension, 1888-1890

Like Palmer, Moffat had aspirations of making D&RG an attractive link for transcontinental traffic, so he pushed several ambitious projects in 1888. First, he continued to widen the main lines from narrow- to standard-gauge so trains belonging to other railroads could roll through Colorado without the cumbersome transfer of people and freight from one car to another. Second, Moffat negotiated with several transcontinental railroads for joint operations on D&RG lines in exchange for trackage fees. Last, Moffat succumbed to the same allure of a direct and dedicated line to Salt Lake City as had Palmer. The Leadville to Glenwood segment figured prominently in these plans.⁵⁰³

Even though Moffat tacitly agreed with Palmer's policies, Moffat did not like nor trust his predecessor. As a general rule, Moffat trusted no other railroad or their signed agreements, including Palmer's D&RGW. Moffat felt that D&RGW was unreliable, open to hostile partnerships, and capable of destabilizing D&RG's western territory. He attempted to distance D&RG from D&RGW and compete directly, suggesting to the board of directors a new line to Salt Lake.⁵⁰⁴

⁵⁰¹ Athearn, 1962:159.

⁵⁰² Bauer, et al., 1990:46; 98.

⁵⁰³ Athearn, 1962:167; Osterwald, 1991:81.

⁵⁰⁴ Athearn, 1962:170.

Moffat knew the stockholders would not front all the costs for the entire line at once, so he broke the project into strategic segments that would benefit D&RG even if the Salt Lake idea was abandoned. Overall, the strategic segments would follow the Colorado River from Glenwood Springs to Grand Junction and become D&RG's main transcontinental link. The new route would replace the existing main line over the Collegiate Mountains through Montrose. In 1888, D&RG directors organized the Rio Grande & Pacific Railroad Company to build the first segment from Glenwood Springs to Rifle. The following year, Moffat sought capital to continue grading toward Grand Junction. For unknown reasons, Moffat contacted rival James J. Hagerman of Colorado Midland, inquiring whether he would jointly fund the project, to which Hagerman agreed. The two boards of directors established the Rio Grande Junction Railway Company to build a standard-gauge track and voted Charles H. Toll director. As competitors, Moffat and Hagerman disliked each other, however, and their wary relationship kept the venture unstable.⁵⁰⁵

Moffat and Hagerman each engaged in backroom decisions that ruined the joint venture's chances of success. The Missouri Pacific & Rock Island Railroad announced it would use the new Colorado River line to run trains through Colorado to Utah, but all traffic would go to Colorado Midland. D&RG had not yet converted the Leadville to Glenwood segment to standard-gauge, which the Missouri Pacific required. Colorado Midland, however, was standard-gauge for its entire length, and the Missouri Pacific could route its trains over Colorado Midland through Aspen to Glenwood Springs and onto the joint Colorado River line. Moffat was jealous and came up with a plan to capture the lost traffic. He simultaneously slowed construction of the joint Colorado River section while speeding the standard-gauge conversion between Leadville and Glenwood so that both would be finished at the same time and ready for business as a continuous thread. D&RG finished the standard-gauge conversion in 1889, completed the Colorado River segment the following year, and then opened the entire line to transcontinental traffic.⁵⁰⁶ While Moffat was quietly manipulating construction timing to favor D&RG, Hagerman sold Colorado Midland to AT&SF. D&RG had long wanted to buy Colorado Midland, but Hagerman purposefully worked with D&RG's rival AT&SF out of spite for Moffat. By purchasing Colorado Midland, AT&SF violated the Treaty of Boston that Gould drafted nine years earlier. The treaty required AT&SF to remain south and east of the Rio Grande River and not operate lines competitive with D&RG. Moffat was forced to cooperate with AT&SF.⁵⁰⁷

D&RG Operations Stabilize, 1891-1899

When AT&SF purchased Colorado Midland in 1889, it secured a right-of-way from Colorado Springs through Leadville to Aspen, down the Roaring Fork Valley to Glenwood Springs and west to Grand Junction. Moffat gained new insight into Palmer's motivation for the early 1880s expansion campaign, as the presence of AT&SF compelled him to pursue the same policy. Moffat reasoned that if D&RG did not hasten into new mining areas such as Creede, AT&SF would capture those markets. When Moffat approached the board of directors for expansion funds and explained his rationale, they refused. The board not only wanted to avoid more debt, but also it accused Moffat of planning new lines to serve mining districts in which he and fellow D&RG officers held interests. This was slightly unfair because Moffat and associates

⁵⁰⁵ Beebe, Lucius and Clegg, Charles. *Rio Grande: Mainline of the Rockies*. Berkeley, CA: Howell-North, 1962, 276; Athearn, 1962:170; LeMassena, 1984:361.

⁵⁰⁶ Athearn, 1962:173.

⁵⁰⁷ Athearn, 1962:173; LeMassena, 1974:57; LeMassena, 1984:144.

owned mines in most of Colorado's principal districts. In 1891 Moffat resigned, taking with him officers such as Sylvester T. Smith, who were also members of his mining investment syndicate. D&RG's British investors replaced Moffat with their associate Edward T. Jeffery, who cancelled all expansion projects, trimmed operating costs, and deferred maintenance to save money. Jeffery was highly effective, and in two years, he not only paid off all D&RG's debt, but began producing dividends. The stockholders and board were impressed and intended to retain Jeffery, even if he allowed D&RG to deteriorate physically.⁵⁰⁸

During the mid-1890s, Jeffery's policies and management style allowed D&RG to weather one of its greatest challenges to date. At the end of 1893, the Silver Crash caused mining throughout the West to collapse. The resultant financial panic ruined many railroads but D&RG survived. As metal mining declined, Jeffery turned to coal, coke, lumber, and agriculture for bulk freight, much of which went out of state. As the depression deepened in 1894, Colorado Midland and Denver, Leadville & Gunnison Railroad (formerly DSP&P) went under, leaving D&RG as the only solvent system in Colorado. But all was not well as the carrier lost a weighty forty percent of its income and still faced competition from the other railroads, which continued to operate even though bankrupt. Despite the heavy loss in income, however, Jeffery was still able to meet financial obligations and guide the railroad into better times.⁵⁰⁹

At the turn of the century, business recovered and Colorado enjoyed a revival of its mining industry. The net result was an increase of traffic, and hence income, for D&RG. Jeffery continued to avoid debt, reduce expenses, and refrain from costly expansion, which allowed the railroad to resume paying dividends to stockholders. During this time, Jeffery began active tourism promotion to enhance passenger business, especially to the major resort community of Glenwood Springs. Maintenance was an area where Jeffery sought savings, which resulted in poor service and a wave of accidents that tarnished the railroad's reputation, however. Ridership was not as high as it could have otherwise been, and when ownership of the railroad changed in 1900, these matters only grew worse.

D&RG Operated by George Gould, 1900-1915

During the late 1890s, George Gould, son of Jay, sought to fulfill his father's grand plan of assembling a transcontinental railroad. He owned the Missouri Pacific and a chain of other railroads linking Denver with the east coast. Gould sought western links to complete his system, realizing he would have to buy them because building a new line from Denver all the way to the Pacific Ocean was too costly. He targeted D&RG and D&RGW, since they provided a connection between Missouri Pacific in Denver and Central Pacific at Ogden, Utah. Gould began buying D&RG stock during the 1890s, was elected to the board of directors, and gained control as chair in 1900. Gould next purchased D&RGW in 1901 from Palmer, who had been discussing its sale to D&RG for several years. Gould operated the two railroads as one, but allowed them to keep their separate identities.⁵¹⁰

Securing the last piece of the system, from Ogden to the west coast, eluded Gould and became the ruin of D&RG and D&RGW. Gould surveyed the existing railroads and found them in the hands of hostile transcontinental interests unwilling to cooperate with his competing venture. Gould realized he would have to build his own line west out of Utah and organized the Western Pacific Railroad to do so. Financing was a problem, in part because his rivals influenced

⁵⁰⁸ Athearn, 1962:175; LeMassena, 1974:67; LeMassena, 1984:144; Stone, 1918, V.1:362.

⁵⁰⁹ Athearn, 1962:181, 184; LeMassena, 1974:67; LeMassena, 1984:145.

⁵¹⁰ Athearn, 1962:191, 195; Beebe and Clegg, 1962:276; LeMassena, 1974:74; LeMassena, 1984:147.

the banking houses and their loans. In response, Gould arranged a shaky scheme to fund Western Pacific on the backs of D&RG and D&RGW. He used the two railroads as collateral for bonds and other loans, making them responsible for not only paying interest, but also any operating deficits that Western Pacific incurred upon completion. The only way that D&RG and D&RGW could remotely hope to meet these onerous obligations was to completely divert all income and reduce operating expenses even more than Jeffery had done to date, leaving nothing for maintenance or repairs. The only exception to the revenue reallocation was the payment of dividends to keep stockholders content.⁵¹¹

For four years D&RG and D&RGW operated under the weight of Western Pacific, which Gould began building in 1905. As planned, all income generated by the two railroads was diverted and almost nothing reinvested in their upkeep. As a result, the wave of accidents that began during the late 1890s under Jeffery grew worse and service declined even more. Mechanical unreliability, dirty and worn equipment, wrecks, and slow speeds due to inadequate locomotives and poor tracks discouraged both passenger and freight traffic. Some people even referred to D&RG as the Dirty & Rough Going Railroad. As business dropped off, so did the revenues that Gould had based his financial equations on.

In 1910, Gould completed the Western Pacific, and the next year had his coast-to-coast railroad assemblage in full operation. Gould enjoyed his dream for a short time before it unraveled. The trouble started after the organization of Western Pacific. Directors of UPRR and the banking house of Kuhn, Loeb & Company merged to form the Equitable Trust Company, which held some Western Pacific bonds. To harass Gould, Equitable Trust Company insisted on regular payments, which officials knew was impossible because of D&RG's poor earnings. Around the same time, UPRR and Equitable directors bought large blocks of stock in D&RG and Missouri Pacific, appointing hostile members to the boards of directors. The new directors quietly undermined Gould's financial equation by prioritizing dividends, some loans, and maintenance over bond payments, which caused D&RG to repeatedly default on its obligations to Equitable.⁵¹² Gould unknowingly helped UPRR by making his own errors, including overestimating the amount of business that his system could develop. Western Pacific realized much less freight traffic than projected, in part because the railroad had to convince customers to switch from existing transcontinental carriers. As a result, the Western Pacific operated at a large deficit, which D&RG was obligated to make up by contract. This D&RG was unable to do because it was already loaded with debt, and the poor physical state created by Gould's scheme and Jeffery's fiscal conservatism discouraged business.

Gould's empire had not yet collapsed, but Gould grew deeply anxious over the viability and stability of his transcontinental system and knew he was losing control. In 1912, Gould attempted to consolidate several of his western railroads by replacing Jeffery as president of D&RG with Benjamin F. Bush, who was also president of Missouri Pacific. Bush began a campaign of improvement but made little headway because the obligations to support Western Pacific left him with no funding.⁵¹³ By 1914, it was obvious to the directors of D&RG and Missouri Pacific that Western Pacific threatened the solvency of all three railroads. Missouri Pacific officials owned most of the preferred stock in D&RG, and if D&RG went bankrupt due to Western Pacific, they would lose their stock interests. The board recommended restructure of Western Pacific finances, and a meeting with the Equitable Trust Company, which held the bonds. As can be predicted, UPRR forces used this opportunity to strike. The Equitable directors

⁵¹¹ Athearn, 1962:207; LeMassena, 1974:78; LeMassena, 1984:151.

⁵¹² Athearn, 1962:195, 214; LeMassena, 1974:117, 125; LeMassena, 1984:157, 163; Osterwald, 1991:95.

⁵¹³ Athearn, 1962:218; LeMassena, 1974:125; LeMassena, 1984:163; Stone, 1918, V.1:363.

refused to restructure the debt, knowing this would wreck D&RG and Western Pacific, instead recalling outstanding bonds. They did so on the grounds that too many payments had been missed, and that the ramshackle state of D&RG made full repayment unlikely. The bond recall forced Gould to sell Western Pacific to hostile interests. Gould now had to rely on the junction between UPRR and his D&RGW at Ogden to continue transcontinental service. UPRR, however, struck again in 1915 by closing its Ogden connection with D&RGW, severing Gould's system and eliminating it as a transcontinental carrier.⁵¹⁴

D&RG Reorganized, 1916-1920

When Gould lost Western Pacific in 1915, he seized control over his other railroads and wrested D&RG back from UPRR. In an attempt to redeem and promote D&RG, he packed the board of directors with cronies, appointed Henry U. Mudge as president, and personally inspected the system. Gould pledged to Colorado residents that he would repair long-deferred problems and restore the railroad to its former glory, although his train then ironically derailed and toppled over due to faulty tracks. The wreck symbolized the trend followed by the rest of Gould's empire.⁵¹⁵ After plucking Western Pacific from Gould's system, the Equitable Trust Company next set its sights on D&RG. When Equitable recalled its Western Pacific bonds in 1915, that railroad was sold at auction to repay as much of the total as possible. The purchase price of the railroad was substantially less, however, leaving a large unpaid balance that Equitable sought to fill. Equitable next trained its sights on D&RG, obligated by contract for Western Pacific's debts, and began bankruptcy proceedings in 1917. Behind the scenes, UPRR directors hoped not only to recover the outstanding balance, but also to buy the railroad at auction, gain control, and further dismantle Gould.⁵¹⁶

This was unacceptable to the directors of Missouri Pacific because they faced heavy financial losses if Equitable foreclosed. Equitable's bonds had primary rights and would be repaid first when D&RG was auctioned, leaving little to cover their loans to D&RG. Further, the directors owned thirty percent of preferred stock and still had control over the railroad. Equitable and Missouri Pacific directors raced each other to foreclose on D&RG. But before either party was successful, the U.S. Railroad Administration assumed control of D&RG as part of its World War I mobilization campaign. The Administration kept D&RG in stasis and operating until 1920, when it released all rail carriers. Ready to pounce, Equitable instituted foreclosure proceedings without resistance. The Missouri Pacific directors had dumped their stock in the meantime and were no longer interested in secondary foreclosure.⁵¹⁷

In 1920, J.F. Bowie and associates, who purchased Western Pacific when it was bankrupted, bought D&RG at auction for \$5 million, leaving worthless the \$88 million in common stock held by average investors. Bowie combined D&RG and D&RGW into a new company with the old name of D&RGW. Bowie now owned all the western links in Gould's former transcontinental system, and because D&RGW was again physically connected with Western Pacific, D&RG saw a return of transcontinental traffic to its tracks, including the Leadville to Glenwood segment.⁵¹⁸

⁵¹⁴ Athearn, 1962:230; LeMassena, 1984:169; Stone, 1918, V.1:363.

⁵¹⁵ Athearn, 1962:231; LeMassena, 1974:129; LeMassena, 1984:169.

⁵¹⁶ Athearn, 1962:237; LeMassena, 1974:129.

⁵¹⁷ Athearn, 1962:236, 239; LeMassena, 1984:172.

⁵¹⁸ Athearn, 1962:241; LeMassena, 1974:131; LeMassena, 1984:172.

D&RG and Transcontinental Service, 1921-1929

Bowie possessed D&RG only a short time before financial problems threatened their ownership. In 1921, one of the worst winters on record washed out the central Pueblo yard and miles of tracks elsewhere, interfering with traffic. Repair costs were high and significant revenue was lost due to the inconsistent service that resulted. In addition, residue left from Gould's complex financial scheme continued to shadow D&RG. The Bankers Trust Company of New York and the New York Trust Company held significant unpaid mortgages that Bowie inherited from D&RG, which were overdue. In 1922, the two financial firms initiated a new round of foreclosure proceedings to recover their loans, forcing D&RGW (now including D&RG) into receivership again. The court took charge of D&RGW and appointed Joseph H. Young as receiver. Young's duties were to operate the railroad while the court assessed the state of the carrier and examined acquisition proposals. Young reported that the entire system was in such an advanced state of decline that it was dangerous and required immediate repairs if the railroad was to remain viable. The court ordered Young to address the maintenance backlog, and he invested \$8 million in the most pressing issues. The main line from Pueblo to Grand Junction, including the Leadville to Glenwood segment, received the most attention. Steep grades were reduced, sharp curves realigned, and wooden bridges replaced. These were the first improvements the railroad had seen in decades, which impressed Colorado businesses and riders. Regardless, D&RGW was a long way from being in sound condition.⁵¹⁹

The ICC and bankruptcy court began hearings to examine proposals for reorganization of D&RGW. The directors of Missouri Pacific and Western Pacific expressed their desire to buy it. In response, Denver and Colorado businesses loudly protested that these two owners would continue to rob D&RGW of its funds at the cost of service and safety. Government railroad experts suggested the Chicago, Burlington & Quincy (CB&Q) acquire D&RGW, which would restore transcontinental traffic through Colorado. As a testament to the poor state of D&RGW, CB&Q declined on grounds that the purchase and rehabilitation costs were too high. ICC experts then recommended AT&SF absorb D&RGW. Colorado interests claimed that this would give AT&SF a monopoly over Colorado, prevent transcontinental traffic, draw business out of the state, and discourage expansion into northwestern Colorado.⁵²⁰

In 1924, after lengthy arguments, the ICC allowed the directors of Missouri Pacific and Western Pacific to buy D&RGW for around \$18 million. Howls of protest went up from the press, governor, attorney general, and business interests. J.S. Pyeatt, former director of Gulf Coast Lines, was appointed president. He stated that D&RGW would be operated as an independent system with itself as the main recipient of funds. As Colorado parties suspected, Pyeatt diverted a considerable amount of funds to Missouri Pacific and Western Pacific, but these two railroads also used D&RGW as a transcontinental link, which provided substantial revenue between 1926 and 1928. Even though D&RGW continued to be bilked by its owners, the railroad was finally profitable and out of shadow of Gould, almost ten years after he lost control of the carrier.⁵²¹

Shortly after the ownership disputes had been settled, D&RGW became entangled in another set of debates. In 1921, the Colorado State Legislature passed a bond to fund the Moffat Tunnel, a railroad bore projected to pass underneath the Continental Divide at Rollins Pass. Denver and northwestern Colorado supported the measure because it would improve the existing

⁵¹⁹ Athearn, 1962:246, 254; LeMassena, 1974:135; LeMassena, 1984:172; Osterwald, 1991:101.

⁵²⁰ Athearn, 1962:254.

⁵²¹ Athearn, 1962:255; LeMassena, 1974:139, 145; LeMassena, 1984:172.

Denver & Salt Lake Railroad (D&SL) route and divert water to the Front Range. The D&SL was a reorganization of David Moffat's Denver, Northwestern & Pacific Railroad, established in 1902 as a transcontinental link between Denver and Salt Lake City. Denver long aspired to have its own transcontinental link directly west over the Divide, and Moffat provided them hope in the form of his railroad. The proposed route went west from Denver over the Divide into Winter Park and through the northwestern quarter of the state, which lacked rail service. Tracks went as far as Steamboat Springs, where the project stalled due to funding issues. The Divide was the railroad's undoing. As much as forty-one percent of all operating costs went to clearing the tracks of snow and double-heading engines to pull trains, and because of this, the railroad struggled. In 1911, Moffat died, his railroad went bankrupt, and Newman Erb reorganized it in 1913 as the D&SL. At this time, Erb proposed solving the Divide problem with a tunnel but was unable to secure enough money. As long as the new railroad languished, the transcontinental carriers and D&RGW in particular were content. If finished, D&SL would bypass them as the shortest and quickest route through Colorado.⁵²²

When William Evans and David C. Dodge began the tunnel in 1922, D&RGW mobilized. The directors proposed a connection between D&SL and Dotsero on the Leadville to Glenwood segment, known as the Dotsero Cutoff. The connection would ascend the Colorado River from a junction at Dotsero and tie into the D&SL line at Orestod, which was Dotsero spelled backward. D&RGW directors reasoned that the Cutoff would provide Denver with its transcontinental link and negate the need to push D&SL all the way to Utah. The outstanding question was: who would build the Cutoff and absorb the extremely high construction costs? Whichever railroad graded the line wanted assurances of enough traffic to repay necessary loans.

D&SL director Gerald Hughes suggested that he would build the Cutoff, but only under several conditions. First, D&RGW must divert its transcontinental traffic to the Cutoff and pay D&SL trackage fees for its use. Second, the D&SL would carry freight between Orestod and Denver with its own locomotives for a transfer fee. Hughes threatened that if the D&GRW did not agree to these terms, D&SL would finish the original line to Salt Lake City and provide serious competition. In response, D&RGW counsel Henry McAllister offered several alternatives. First, his railroad would allow its connection with the Cutoff only if D&RGW could build and own it. Second, D&SL could build the Cutoff if D&RGW could then lease the entire D&SL system. Third, D&SL had to grant a track sharing agreement from Dotsero to Denver and allow D&RGW trains full-length runs. William H. Williams, chair of D&RGW board, added that if an agreement could not be reached, D&RGW would build its own direct connection to Denver and cut D&SL out altogether.⁵²³

The negotiations consumed several years and reached no conclusion by 1927, when the tunnel was complete. Denver residents were furious over the deadlock, because without a connection to Salt Lake City, they perceived the tunnel as a costly waste of funds that accrued unpaid interest as long as it was unused. In 1929, D&RGW officials quietly attempted to resolve the dispute by acquiring D&SL stock to stage a takeover. D&RGW, however, found that it needed 80 percent of the railroad's common stock to win control, which could not be purchased in a short amount of time. A resolution to the dispute, and the willingness of any party to build the Cutoff, were suddenly cast into doubt with the Great Depression. The various railroads had other matters to worry about, and loans for large projects such as the Cutoff became impossible to secure.⁵²⁴

⁵²² Athearn, 1962:261; LeMassena, 1984:115, 205.

⁵²³ Athearn, 1962:277.

⁵²⁴ Athearn, 1962:284; LeMassena, 1984:182.

D&RGW Builds the Dotsero Cutoff, 1930-1933

The Great Depression spared no industry. Consumer demand for all goods and services fell, and the credit that businesses relied on disappeared. Manufacturing and commerce ground to a halt, and the movement of freight and people slowed significantly. Colorado also suffered a collapse of its already weakened mining industry, exacerbating the depression's regional impact. On a national level, the railroad industry was hit hard because it relied on movement of people and goods for income. Colorado carriers in particular, such as D&RGW, faced a crisis because mining accounted for a high volume of their mountain traffic. At least D&RGW received some revenue from transcontinental freight, while other carriers were not as fortunate. However, D&RGW's income fell by around one-half during the Great Depression, forcing the railroad to apply to the Reconstruction Finance Corporation (RFC), a federal support agency, for a loan to remain solvent. The RFC provided the loan, which only postponed inevitable problems.⁵²⁵

D&SL was in even worse condition than D&RGW because its line was short, extremely costly to operate, and depended largely on logging in Winter Park and agriculture to the northwest, both of which barely survived. With D&SL on the brink of shutting down, its directors realized that the Cutoff would bring D&RGW transcontinental traffic onto their line and increase earnings. In this condition, the D&SL directors grew more amiable to reaching an agreement with D&RGW, which wanted the Cutoff as well. Thus, the parties consulted the ICC in 1931, which recommended a cooperation similar in structure to the proposals discussed years earlier. All parties agreed that D&RGW could buy the remaining stock in D&SL and the Denver & Salt Lake Western Railroad, a paper company that D&SL directors organized to secure the Cutoff right-of-way. D&RGW had to allow D&SL to remain independent. D&RGW would then build and own the Cutoff, and D&SL must grant passage to D&RGW trains to Denver for a trackage fee. The ICC stipulated that D&RGW had to begin building the Cutoff in six months, open it to traffic in two years, and make improvements to the Moffat Tunnel to handle the increase in traffic.⁵²⁶

The collapsing economy threw a wrench into the plan. Because of falling revenue, D&RGW was unable to buy D&SL stock, pay for Cutoff construction, or make necessary improvements to the Moffat Tunnel. D&RGW officials applied to the ICC for an extension and to the RFC for a \$3,850,000 loan. Once provided, the railroad began grading. As railhead settlements, Dotsero and Orestod hosted construction camps, and acted as conduits for materials flowing along the Colorado River to points of work. Dotsero became the most important of the two settlements as it was largest, had already been in existence for fifty years, and lay at the junction of the Cutoff and D&RGW's Leadville to Glenwood segment (see Illustrations A 5.16 and A 5.17). Because of the project, Dotsero drew a permanent population sizeable enough to justify a post office, granted in 1933. As a combination water and fuel stop, regional station, rail junction, and agricultural community, Dotsero retained its post office until 1948. Orestod, however, reverted to an abandoned state when the Cutoff was completed in 1934.⁵²⁷

D&RGW Operates during the Great Depression, 1934-1941

While D&SL and D&RGW managed to come together during the early 1930s and build the Dotsero Cutoff, their relationship was not harmonious. Until the Cutoff was complete and

⁵²⁵ LeMassena, 1974:147.

⁵²⁶ Athearn, 1962:291; LeMassena, 1974:147.

⁵²⁷ Athearn, 1962:296-297; Bauer, et al., 1990:46; LeMassena, 1974:147; LeMassena, 1984:182.

D&RGW trains rolled into Denver, D&SL had to pay Moffat Tunnel usage fees. Once D&RGW traffic passed through the tunnel, D&RGW had to share the costs. Thus, when D&RGW directors brought the Cutoff close to completion during the winter, they laid rails to within only 200' of the D&SL junction at Orestod and stopped. The directors offered feckless excuses for the delay, seeking actually to postpone sharing tunnel usage fees until D&RGW generated enough freight business to offset the costs. The D&SL directors knew why D&RGW was stalling and decided to force the matter by filling the gap themselves, even though it was D&RGW's responsibility. Once completed, D&SL claimed that Cutoff was open to traffic in May 1934.⁵²⁸

Instead of helping the two railroads improve their financial condition as expected, the Cutoff and associated deal pushed them over the edge. D&RGW was unable to simultaneously meet its new obligation to buy the D&SL stock, pay its own corporate taxes, and continue channeling funds to its old bonds and other debts. In 1934, D&RGW applied to the RFC for yet another loan, which was granted under pretenses that were radical for a federal agency. The RFC agreed to provide the money in exchange for all D&RGW stock and control of the railroad, which constituted government takeover of a private company. Such conditions were not preferred but necessary because failure of D&RGW could trigger a domino effect. D&SL, the Silverton narrow-gauge, and other dependent railroads would go bankrupt and ruin already weakened economies in their areas. When the RFC assumed D&RGW, it forced out existing management and appointed Wilson McCarthy as director.⁵²⁹

Including the RFC loans, D&RGW was in debt for \$122 million and had little hope of repaying its creditors. In a worn pattern, the bondholders recalled their primary loans in 1935 and forced the railroad into bankruptcy again. Judge J. Foster Symes represented the court and chose McCarthy and Henry Swan as receivers. They were local to Colorado, and their appointment ended sixty years of absentee control and financial machinations.⁵³⁰

Symes, McCarthy, and the RFC coordinated a plan to put D&RGW back on a paying basis. Such a task was difficult in ordinary times and seemed impossible in the climate of the Great Depression, and yet, they achieved success. To run D&RGW, the trio selected local businessmen with loyalty to Colorado instead of relying on absentee directors of other railroads. Symes then instructed McCarthy to invest \$18 million rehabilitating the entire system. Between 1935 and 1939, the railroad built or repaired 400 bridges and eliminated 114 more, replaced two million rotten ties and 240 miles of worn rails, and improved miles of old roadbeds. D&RGW also purchased a fleet of new rolling stock and fifteen locomotives, extended key sidings to accommodate longer trains, and built more yard facilities. In 1940, McCarthy introduced diesel engines to improve efficiency. Steam locomotives had to stop during ascents for fuel and water and on descents so their brakes could cool, all of which jammed traffic. Although diesels proved inadequate for passenger service, they were excellent for freight, which was most of the business. McCarthy also replaced maintenance trains, which blocked traffic, with off-track heavy equipment and trucks. Last, the system of signal lights known as Centralized Traffic Control was expanded to improve the movement of trains. Similar to traffic lights on today's highways, signal lights in trackside sconces informed engineers when to proceed and when to pull off onto sidings and make way for oncoming trains. Because the Leadville to Glenwood segment was the main transcontinental line, it received many improvements.⁵³¹ Of the unprecedented reinvestment campaign, D&RG historian Robert G. Athearn noted: "Rising from what was described as 'almost a pile of junk' four years before, the road was said now to be one of the most efficient in

⁵²⁸ Athearn, 1962:297.

⁵²⁹ Athearn, 1962:303; LeMassena, 1974:149; LeMassena, 1984:182.

⁵³⁰ Athearn, 1962:305, 306; LeMassena, 1974:149; LeMassena, 1984:182.

⁵³¹ Athearn, 1962:308, 312, 314; LeMassena, 1974:149; LeMassena, 1984:185.

the nation.”⁵³² McCarthy and Symes hoped this would draw transcontinental traffic and redeem the railroad’s reputation. The partners were amply rewarded, because D&RG was about to receive its biggest increase in traffic.

D&RGW Booms during World War II, 1942-1946

When the nation formally entered World War II at the end of 1941, nearly every facet of American industry scrambled to meet new production demands. The railroads shouldered triple duty during wartime mobilization, and most rose to the occasion. First, the rail carriers had to recover from the Great Depression and improve their operating status to accommodate a huge swell in traffic. That meant, as D&RGW had done, rebuilding decayed physical infrastructure and improving efficiency. Second, railroads had to move an unprecedented amount of freight in record time from point of generation to place of need. This freight was primarily resources for the manufacture of weapons, support infrastructure, and food. Last, railroads conveyed both the materials of war and military personnel from inland to the coasts for shipment to battlefields overseas. Between 1942 and 1946, D&RGW carried out all these duties. Colorado mines, sawmills, farms, and ranches turned out raw materials needed to support the war effort, and new businesses produced some finished goods. Shunting local products over to the transcontinental rail carriers for long-distance distribution increased D&RGW’s business. The transcontinental freight that moved across D&RGW’s tracks rose sharply, as well. The Dotsero Cutoff accommodated heavy traffic to Denver, while the Leadville to Glenwood segment saw numerous trains east to Pueblo. D&RGW was a conduit for long trains that traveled west, as well. In particular, the system hosted mass movement of military personnel, weapons, and supplies bound for the Pacific Theater.

The net result for D&RGW was a quick ascent into solvency. Revenue for 1942 increased an astounding 900 percent over that for 1941 and kept climbing. In 1945, income reached an all-time high of \$75 million, up from \$17 million during the mid-1930s. The war ended in 1945, but the traffic did not. International reconstruction and consumer demand, released after fifteen years of restraint due to depression and war, perpetuated local and transcontinental traffic throughout D&RGW system. The income for 1946 dropped to \$51 million, which was still higher than any time in the past. The ICC and RFC determined that D&RGW was again ready to be conveyed back into private ownership. The railroad’s business was sufficient, its financial state sound, and the system was among the best in the nation.

D&RGW Absorbed, 1947-1988

In 1947, D&RGW consolidated with D&SL and returned to private ownership. McCarthy remained president, with Henry Swan as head of the finance committee and Denver capitalist John Evans chairing a board of Colorado businessmen. The previous absentee bondholders were the new owners, and conditions specified in the sale blocked them from the past privations that ruined the railroad. The Colorado management maintained progressive policies that kept D&RGW in sound physical and financial condition. During the 1930s improvement campaign, McCarthy and Swan built a laboratory for studying wear on rail equipment in hopes of reducing failures and saving costs. They developed methods for inspecting boilers, scanning metal parts for minute fatigue, testing improved rails, and developing alloys suited for specific functions. This proved so successful that the American Railway Engineering Association adopted some

⁵³² Athearn, 1962:318.

D&RG standards for rails. Laboratory work continued under the new organization and kept D&RGW on the cutting edge of railroad engineering. D&RGW and the Atomic Energy Commission even went so far as to test nuclear-powered locomotives.⁵³³

McCarthy and staff paid special attention to practical concerns of the railroad system. One was a decline in passenger business during the late 1940s. After the war ended, gasoline was no longer rationed and auto makers returned to production, which made travel by car attractive. To retain as much of the declining passenger business as possible, McCarthy entered a joint project with CB&Q and Western Pacific, in which they bought comfortable passenger cars and sleek locomotives for rapid transcontinental service from Chicago to San Francisco. In 1949, they commissioned the line as the California Zephyr, and its route through the Rocky Mountains caused a stir among riders. One particular addition set the service apart from competing railroads. In 1944, Cyrus Osborn, head of the Electromotive Division of General Motors, rode in the fireman's seat of a freight locomotive through Glenwood Canyon and realized that passengers would pay well to view the fabulous scenery. Osborn came up with the idea of a special passenger car with an elevated observation platform enclosed in a cupola, with seats sold at premium prices. D&RGW formalized the design, contracted with General Motors in 1949 to produce the cars, and introduced them on the California Zephyr line. D&RGW was the first railroad to use observation cars, which made the Rocky Mountain route famous and popular (see Illustration A 5.18). Other railroads then attempted to imitate the experience.⁵³⁴

Despite the success of the Zephyr, D&RGW staff was not idealistic about the future of passenger service and understood that freight was the railroad's most important revenue. Given this, McCarthy took several measures during the late 1940s and early 1950s to increase both regional and transcontinental business. For regional business, he groomed United States Steel, owner of the Geneva steel mill in Provo, Utah, and Colorado Fuel & Iron Company, operator of another steel plant at Pueblo. Both firms consumed enormous volumes of iron ore, fuel, and other materials, and distributed finished products, all hauled by D&RGW. McCarthy also provided reliable and prompt service to agriculture, organizing the Rio Grande Land Company to develop industrial sites and attract business into D&RGW's rail corridors.⁵³⁵

In 1956, McCarthy died and Gale B. Aydelott replaced him as president. His father, James Aydelott, was an official with the Burlington Railroad. Gale joined D&RGW in 1936. Once president, Aydelott maintained McCarthy's vision, management style, and policies, including his interest in increasing transcontinental traffic. For the next several decades, D&RGW settled into a comfortable niche established by McCarthy. The railroad was Colorado's principal carrier, enjoyed a predictable amount of transcontinental traffic, and provided limited passenger service. The 1960s and 1970s were relatively quiet, although D&RGW experienced several changes, mostly beneficial. In 1965, D&RGW and CB&Q reached an agreement over through-traffic, improving the efficiency of transcontinental service. CB&Q allowed D&RGW trains to traverse its tracks as far east as Chicago, while D&RGW permitted CB&Q trains to cross its lines to Salt Lake City. Both railroads paid each other trackage fees in exchange. D&RGW also appealed an ICC decision allowing UPRR and Southern Pacific to charge prohibitive transfer fees at their Ogden, Utah, connection points. The anti-competitive fees intentionally discouraged transfer of certain types of freight onto D&RGW system. D&RGW was victorious in 1968 as the ICC required the hostile carriers to drop their fees. Also in 1968, friendly investors organized Rio Grande Industries to buy D&RGW and further expand the

⁵³³ Athearn, 1962:335, 348.

⁵³⁴ Athearn, 1962:331, 335; Beebe and Clegg, 1962:283.

⁵³⁵ Athearn, 1962:332, 335.

railroad's business opportunities and real estate development. The following year, the new firm acquired D&RGW. Energy consumption increased during the 1970s, so the railroad hauled higher tonnages of coal from mines in Utah and Colorado than ever before.⁵³⁶

After around thirty years of progressive management, D&RGW achieved a status realized by few other railroads. D&RGW retired the last of its bonds and mortgages in 1982, leaving loans for equipment as its only debt. The railroad was now a particularly valuable asset, and D&RGW entertained buyout offers from larger competitors, who applied pressure from all sides of its territory. In 1988, the directors succumbed and sold the railroad to Southern Pacific. UPRR in turn acquired the Southern Pacific in 1996, including ownership of D&RGW system, and closed the main line between Dotsero and Pueblo shortly afterward. The track from Glenwood Springs to Dotsero and through the Moffat Tunnel to Denver remains in use today.

⁵³⁶ LeMassena, 1974:195, 202; LeMassena, 1984:201.

Section A 6: History of Road Transportation, 1859-1962

Introduction

This section provides a brief overview of historic road and trail development in the I-70 corridor. Pack trails and wagon roads were the first elements of what became a complex circulation system, evolving into auto roads and, ultimately, engineered highways. The section draws heavily on two historic contexts: *Highways to the Sky*, developed by Associated Cultural Resource Experts (ACRE) in 2002 for CDOT, and the 2003 draft Colorado statewide highway context *Colorado Roads and Highways, National Register of Historic Places Multiple Property Submission*, which was based on *Highways to the Sky* with revisions by the Colorado Office of Archaeology and Historic Preservation.⁵³⁷ Details regarding statewide trends in road engineering, construction, and state and federal road agencies are not recited below to avoid repetition. The reader should consult the above two documents for more information. For information on bridges, consult the *Highway Bridges in Colorado: Multiple Property Submission*.⁵³⁸ When evaluating the significance of specific pack trails and roads within the corridor, additional research may be necessary.

Period of Significance, 1859-1962

In overview, roads and trails were important during the Period of Significance 1859 through 1962. In 1859 prospectors and placer miners began travelling pack trails between Golden and Clear Creek drainage. During the 1860s, heavily traveled routes were converted into wagon roads to meet the demands of a growing mining industry. Trails and roads extended farther west into Summit County during the early 1860s as mining boomed, while the Eagle and Colorado river valley saw little development until 1880. Eventually, roads in each of these regions became links in a system spanning much of the I-70 corridor. Mining, lumber, and toll companies constructed most early roads, which though unpaved and poorly built, were the primary arteries for freight and people. These roads transferred from private to public ownership beginning in the 1890s, and through public stewardship were gradually improved. The Good Roads Movement took hold across the United States around 1905, including Colorado, as automobile owners and bicyclists encouraged better road engineering and surfacing practices. From this movement, roadway construction gradually matured into engineered highways. The Period ends in 1962, fifty years before this report was produced.

Each of the corridor's drainages has its own transportation history, as pack trail and road networks evolved more slowly in some regions than others, in response to different stimuli. Roads and trails in each region thus may be significant during narrower timeframes within the overall Period of Significance, although some principal roads traversing multiple drainages share larger historic trends. Applicable Areas of Significance include Commerce, Community Planning and Development, Economics, Engineering, Industry, and Transportation. Level of significance is local, and could be statewide or national for some resources depending on further research.

⁵³⁷ Associated Cultural Resource Experts. *Highways to the Sky: A Context and History of Colorado's Highway System*. Lakewood, CO: Colorado Department of Transportation, 2002; Autabee, Robert and Deborah Dobson-Brown. *Colorado State Roads and Highways: National Register of Historic Places Multiple Property Submission*. Denver, CO: Colorado State Historic Preservation Office, Colorado Historical Society, (draft) 2003.

⁵³⁸ Fraser, Clayton. *Highway Bridges in Colorado: Multiple Property Submission*. Denver, CO: Colorado State Historic Preservation Office, Colorado Historical Society, 2000.

Most in-use roads have been impacted within the last fifty years through widening, realignment, paving, or other improvements. Although integrity could be affected to a degree, eligibility might not be precluded. The resources in entirety, or segments therein, could be eligible if present character-defining attributes sufficiently convey resource significance. The resources may qualify for nomination under a later Period of Significance as time passes and this context is updated. They can also be evaluated under NRHP Criterion Consideration G, recognizing exceptionally important properties that achieved significance within the last fifty years.

Overview of Pack Trails and Roads in the Corridor

Road development in the corridor was shaped by broad patterns of exploration, natural resource extraction and agriculture, tourism and recreation, and changing transportation technologies. Trappers and surveyors first explored the mountains in search of natural resources, to chart the geography of the Rocky Mountains, and to identify efficient east-west routes across the country. At times they used existing Native American trails and at others blazed their own routes through unfamiliar terrain. This was followed by mining and the development of a recognizable circulation system of pack trails. The Pikes Peak gold rush of 1859 created the critical mass of traffic necessary to establish the system, which evolved organically from use. Almost as quickly, private companies constructed crude roads over the most suitable trails to meet a growing demand for freight delivered by wagon. The purposefully planned roads provided the only routes into the mountains until railroads arrived (Clear Creek drainage in 1877, Blue River in 1882, and Eagle and Colorado rivers in 1886). The railroads did not, however, render roads or pack trails obsolete wholesale. Many communities and industrialized areas lacked direct rail service, depending on local stage and freight outfits for nearly all goods, passengers, and mail. Heavy traffic continued traveling roads between the railroads and local destinations. Further, pack trails were the only way to reach remote mines, logging camps, and hunting areas well into the twentieth century.

Colorado saw a broad trend of road improvement between 1893 and 1909, primarily among heavy used arteries. Roads increasingly came under public stewardship, as county governments began purchasing private roads when their charters expired, or assumed maintenance of roads that were abandoned. At the same time, the national Good Roads Movement demanded more government involvement in road planning, siting, construction, and maintenance. As a result, greater emphasis was placed on professional engineering practices, including grading, paving, and drainage. In Colorado, affluent Denverites backed the movement, seeking better roads for scenic motoring. In addition to lobbying for the establishment of a Colorado Highway Commission in 1910, auto enthusiasts championed the Denver Mountain Parks system, which created a new recreation area in the foothills west of the city with miles of scenic roads.⁵³⁹

The demand for improved roads intensified in the corridor during the 1910s and 1920s as transportation technology shifted from wagons and railroads to automobiles and trucks. Decline of agriculture and natural resource extraction, reduction in railroad service, and the rise of tourism and recreation were major contributing factors. At the same time, automobiles became more affordable to Coloradans, who purchased them in record numbers. Auto ownership increased in Colorado from approximately 15,000 to 300,000 during the 1920s, and two-thirds of

⁵³⁹ Autobee 2003:4, 26.

the 1.4 million tourists traveling to the state arrived by car. Auto camping exploded in popularity during the 1910s and 1920s, fueling the growth of recreation and tourism in the high country. In 1915, the city of Denver opened Overland Park, one of the country's first municipal campgrounds, including a clubhouse with a grocery store and soda fountain, as well as 1,000 camp sites. By 1923, Colorado had approximately 250 auto camps used by some 643,000 campers.⁵⁴⁰ Automobile roads brought Rocky Mountain vacations within reach of a growing segment of the population, reconfiguring the corridor's economy (see Section A:7 History of Recreation).

During the 1920s and 1930s, Colorado followed a national shift to an automobile-based transportation system, with increasing emphasis on professional road engineering practices and coordination between state and federal agencies. Both state and federal legislation made funding available for road improvement projects throughout the 1920s, and integrated several major routes in Colorado into a national highway system. In the corridor, U.S. 40 was designated as a federal highway in 1925 and became eligible for federal funding. New Deal programs of the 1930s mobilized even more resources, with thousands of miles of roads constructed and improved throughout the state. In 1937, U.S. 6 was officially extended from the plains into the mountains, with several sections of existing roads in the corridor being incorporated and thereby benefiting from the federal-aid designation. Portions of U.S. 6 were graded and improved over Loveland and Vail passes, though not completely paved until the 1950s. Road construction stalled in 1941 due to World War II restrictions in materials and labor, but resumed after the war ended.

The Federal Highway Act of 1956 established a modern interstate system and designated Interstate 70 to link Washington D.C. and Denver. With lobbying from Colorado legislators and business leaders, the federal government funded an extension of I-70 west through the Rocky Mountains to Utah. Planners chose U.S. 6 as the I-70 route in 1960, boosting communities in the corridor. Completion of the Eisenhower-Johnson Memorial Tunnels, and the rest of the interstate, provided unprecedented connectivity between Denver and western Colorado, revolutionizing economies, land use, community development, and culture.

HISTORY OF PACK TRAILS AND ROADS, 1859-1962

Pack Trails and Wagon Roads, 1859-1892

Ute Indian tribes inhabited the central mountains long before Anglo-American settlers arrived, foraging in the high country during the summer and at lower elevations in winter. The tribes tended to follow the same general routes when migrating between favored seasonal environments, creating a network of trails primarily through valleys and over the lowest and gentlest mountain passes. This network became the earliest version of an overland transportation system, later used by Anglo explorers, fur trappers, and finally prospectors and miners. Some principal trails were ultimately converted into wagon roads.⁵⁴¹ But before this, road builders and even Anglo trailblazers avoided the mountains. During the westward migration of the mid-nineteenth century, wagon trails crossed the plains to the base of the mountains, then turned

⁵⁴⁰ Abbott, Carl, Leonard, Stephen, and McComb, David. *Colorado: A History of the Centennial State*. Niwot, CO: University Press of Colorado, 1994 [1982], 239-240.

⁵⁴¹ Norman, Cathleen. *Historic Contexts Report: 1999-2002 Cultural Resource Survey of Unincorporated Jefferson County*. Lakewood, CO: Preservation Publishing, 2002, 15.

north and went around. They realized that the topography was too difficult for wagons to navigate.⁵⁴² Nearly all early east-west routes crossed the Continental Divide at South Pass, Wyoming, the low point of the Rocky Mountains.

During the 1840s, the federal government began dispatching exploration parties in hopes of locating new east-west routes through the Rocky Mountains, and to understand their geography and natural resources. Several passed through the I-70 corridor. John C. Fremont's 1842 expedition examined the South Pass region of Wyoming for potential military posts, and his second expedition in 1844 brought him into the central Colorado mountains. Entering from the northwest, he traveled down Middle Park, followed the Blue River through Summit County to Hoosier Pass, and traversed South Park.⁵⁴³ Fremont's was the first U.S.-commissioned expedition to cross this section of the state. His expeditions tended to follow Native American trails because they were natural travel corridors, subsequently utilized for wagon roads and, ultimately, paved highways.

On his third expedition in 1845, Fremont returned to the central Rocky Mountains en route to the Great Basin. He traced the Arkansas River to its head waters, crossed Tennessee Pass to the head of the Eagle River, and descended to present-day Minturn. This route was later developed with a pack trail and then a wagon road, which became part of U.S. 24. Fremont continued west along the Eagle to the Colorado River, followed it north, and then paralleled the White River into Utah. The trip was the first recorded Anglo expedition through the Eagle and Colorado river valley.

John Wesley Powell led the next and final federal expedition to venture through the I-70 corridor. In 1867, the Powell expedition, the U.S. Geological Survey's first, began in Bergen Park, traveled to Central City, and went west to Middle Park. The group then followed the Colorado River to its confluence with the Eagle River, continuing along the Colorado to Green River, Utah, roughly paralleling I-70. The expedition was an important step in quantifying central Colorado's natural resources, natural environment, and river network.⁵⁴⁴

It was the lure of financial gain that ultimately brought pack trail and road networks into Colorado's mountains. Discovery of gold on Cherry Creek in 1858, and the resulting Pike's Peak gold rush, drew prospectors to Colorado's piedmont region, where they platted Denver, Golden, Apex, and other settlements. Prospectors rushed west into the mountains in 1859 and 1860 in pursuit of more gold discoveries, establishing mining camps near the centers of activity. At the time, it was difficult to obtain supplies because the region lacked professionally built roads.⁵⁴⁵

Until roads were completed, prospectors and miners hauled goods and equipment in wagons as far as they could, before finishing their journeys by pack animal. Such traffic tended to follow Native American trails and other natural routes into Clear Creek drainage and beyond. Most routes were poorly documented pack trails, but one known as the Prospector's Trail was among the most heavily travelled (see Illustration A 6.1). The route meandered southwest from Golden up Lookout Mountain, through Mount Vernon Canyon and Kerr Gulch, to Idaho Springs. The trail, later converted into a wagon road, followed Clear Creek to Georgetown.

Prospectors also found gold near Breckenridge in 1859, leading to a substantial rush in the Blue River drainage the next year. Prospectors and miners crossed over the Divide from South Park and Clear Creek, creating artery pack trails. Loveland and Argentine passes in

⁵⁴² King, Joseph. *Colorado Engineering Context*. Denver, CO: Colorado Historical Society, 1984, 89.

⁵⁴³ Stone, Wilbur Fisk. *History of Colorado, Vol. 1*. Chicago, IL: S.J. Clarke Publishing Co., 1918, 59.

⁵⁴⁴ Mehls, Steven. *Colorado Mountains Historic Context*. Denver, CO: Colorado Historical Society, 1984, 27.

⁵⁴⁵ Ubbelohde, Carl, Maxine Benson, Duane Smith. *A Colorado History* [9th Edition]. Boulder, CO: Pruett Publishing, 2006, 75.

particular were heavily traveled. At the same time, California Gulch, near present Leadville, became the focus of yet another rush, and prospectors established an artery trail from the Blue River south up Ten Mile Canyon to Fremont Pass. By 1861, activity along Blue River was intense enough to justify several wagon roads, and one of the earliest routed from Denver to Bergen Park, south to Tarryall in South Park, and over Georgia Pass.⁵⁴⁶

A rudimentary system of pack trails grew from the constant flow of men and animals over the same routes. Few trails were purposefully built, most developing organically along paths of least resistance to specific destinations. Travelers preferred routes with the gentlest slopes, shallowest water crossings, and fewest obstacles. Artery trails often manifested as between one and several sinewy treads, worn through foot traffic, and constantly joining and separating. In some areas, users improved trails by pitching rocks aside, cutting treads out of slopes, and laying logs on edges to retain soil.

Notwithstanding, the use of pack trails to travel from Denver or Golden to the gold fields was a brief period. As mining camps grew into established towns during the 1860s, the trail system proved inadequate for the greater amounts of supplies transported from plains settlements. Wagons could carry more than a pack animal, but the lack of roads prevented their use. In response, entrepreneurs began a road-building movement. See Table 6.1 for a summary of early roads and later additions.

Table A 6.1: Wagon Roads in I-70 Corridor

Builder/Company	Date Organized	Route	Drainage
Bakerville & Leadville Toll Road Company (also known as the High Line Wagon Road)	1879	Bakerville up the Middle Fork of S. Clear Creek over Loveland Pass, down Snake River to Blue River. Up Ten Mile Creek to Carbonateville to Leadville	Clear Creek, Blue River, Ten Mile Creek
Central & Georgetown Road Company	1860	Central City up Eureka Gulch, down York Gulch, to Fall River. Up S. Clear Creek to Georgetown	Clear Creek
Clear Creek Wagon Road	1864	South Clear Creek to Empire City, with branches to Georgetown and Central City	Clear Creek
Clear Creek Wagon Road Company	1862	Idaho Springs along S. Clear Creek to Floyd's Ranch. One branch extended three miles to Bergen's ranch and intersected with Denver and Tarryall road. Another branch extended one mile to Central City and Mount Vernon road.	Clear Creek
Denver, Auraria, Colorado Wagon Road Company	1859	Denver to Mount Vernon. One branch to Tarryall in South Park. Another branch to Hot Sulphur Springs on Blue Fork of the Colorado River	Clear Creek, South Park, Middle Park
Denver, Bradford, & Blue River Wagon Road Company	1861	Denver via Bradford (Confier), to Hamilton, to Breckenridge	Blue River, South Park
Dotsero Toll Road	1883	Eagle River and Gypsum Creek to Dotsero	Eagle River
Eagle City & Leadville	1879	Eagle City to Piney on Tennessee Creek to Leadville	Eagle River

⁵⁴⁶ Stone, 1918: 576.

Toll Road			
Eagle City & White River Toll Road Co.	1879	Eagle City to base of Baxter Mountain, down Eagle River to junction with Colorado River	Eagle River, Colorado River
Eagle River Toll Road	1879	Eagle City and Red Cliff, down Eagle River through Battle Mountain, to the Colorado River	Eagle River, Colorado River
Evans, Leadville, & Green River Toll Road Company	1879	From Leadville over Tennessee Pass to head of Eagle River. Down to Colorado River, north to Egeria Park to Hot Springs	Eagle River, Colorado River, Middle Park
Genesee Wagon Road Company	1859	Cold Spring Ranch near Apex to Apex Town. Mount Vernon Town, up Mount Vernon Gulch to Genesee Ranch, to Bergen Park	Clear Creek
Georgetown & Breckenridge Wagon Road	1867 Public in 1890	Georgetown over Irwin Pass into Summit County, down the Snake River	Clear Creek, Blue River
Georgetown & Empire Wagon Road	1874	Georgetown to Empire via Union Pass	Clear Creek
Georgetown & Middle Park Wagon Road	1878	From Empire to foot of Berthoud Pass, to Fraser Creek and Vasquez Fork. Northwest to Hot Sulphur Springs	Clear Creek, Middle Park
Georgetown & Silver Plume Wagon Road Co.	1873 Public in 1893	Georgetown to Silver Plume	Clear Creek
Georgetown & Ten Mile Road Company	1879	Georgetown, over the Divide, down the Snake River to Montezuma. To Frisco, up Ten Mile Creek to Recen and Kokomo. Over Fremont Pass to Leadville	Clear Creek, Blue River, Ten Mile Creek
Glenwood Springs, Carbonate & Eagle River Wagon Toll Road, Telegraph, & Telephone Company	1885	Glenwood Springs up Colorado River to mouth of Grizzly Creek. Up to Carbonate and Colorado River to Dotsero	Eagle River, Colorado River
Idaho & Beaver Creek Wagon Road Company	1872 Public in 1896	Purchased route from Clear Creek Wagon Road	Clear Creek
Idaho & Floyd Hill Wagon Road	1860	Idaho Springs to Floyd Hill	Clear Creek
Idaho Springs & Fall River Wagon Road	1860	Idaho Springs to Fall River	Clear Creek
Kelly's Toll Road	--	Bighorn to Vail to Dowd's Junction, Minturn, Two Elks Pass	Eagle River
Kokomo Toll Road	1881	Georgetown to Silver Plume, over Loveland Pass to Montezuma, Frisco, and Leadville	Clear Creek, Blue River, Ten Mile Creek

Table A 6.1, continued

Builder/Company	Date Organized	Route	Drainage
Leadville Free Road	--	Turn off Mount Vernon Road at New York Ranch, south side of Genesee Mountain, ending at Bergen Park	Clear Creek
Leadville, Eagle River, & White River Toll Road Company	1880	Leadville to Evans Creek, up the Arkansas River, and over Tennessee Pass. Down White Pine Creek to Little Piney Creek, to Eagle River. Down Eagle River to Red Cliff. Down Eagle River to Colorado River. Cross near the Ute Trail to the White River Indian Agency	Eagle River, Colorado River Middle Park
Mount Vernon Toll Road	1859	Town of Auraria to Mount Vernon. Bergen's Ranch to Bradford Junction (Conifer) through Jefferson to Tarryall	Clear Creek. South Park
South Park, Blue River, & Middle Park Wagon Road Company	1866	Tarryall to Breckenridge, down Blue River to Dillon, then to Middle Park	Blue River, Middle Park
Sweetwater & White River Toll Road Company	1885	Dotsero to the mouth of South Fork of the White River, with branches to Carbonate and Defiance Mining Camp	Eagle River, Colorado River
Ten Mile & Eagle River Toll Road Company	1880	Ten Mile Creek to Black Lakes, down south fork of Piney to Eagle	Ten Mile Creek, Eagle River
Tennessee Pass & Red Cliff Wagon Road Co.	1885	From Tennessee Pass down Little Piney Creek to Eagle City	Eagle River

The growth of placer mining, its transition to hardrock industry, and associated settlement fostered a network of pack trails and wagon roads throughout Clear Creek drainage and into Summit County (see Illustrations A 6.2 and A 6.3). Although cooperatives of mining interests helped construct some roads, entrepreneurs saw the need for roads as an opportunity and source of profit, forming toll companies. In pooling capital, they were able to complete a number of routes to principal centers of mining. The Griffith family, for example, graded the earliest road into western Clear Creek drainage for two purposes. One was to access their mining claims, homesteads, and townsite known as George's Town. The other was to open the western drainage to development and charge tolls for use of the road. The road, completed from Central City by 1861, had the desired result, their townsite becoming a supply point and gateway to the Summit County goldfields.

Colorado's territorial legislature passed several bills between 1860 and 1862 authorizing toll roads and bridges. But the territorial government was not in the business of road-building itself, instead deferring to private toll road companies. Between the early 1860s and 1890s, forty-three toll roads were chartered and constructed in the territory, ones in or near the I-70 corridor listed in Table A 6.1.⁵⁴⁷ Even more were in the planning stages but failed for various reasons.⁵⁴⁸

⁵⁴⁷ Autabee and Dobson-Brown, 2003, E-17.

Early wagon roads were primitive at best. Most were little more than pathways of wagon wheel ruts from which the largest rocks had been removed.⁵⁴⁹ The roads followed gentle gradients when available, but often climbed and descended winding canyons. The roadbeds were narrow, poorly graded, rough, and rocky. Because construction, maintenance, and return on investment consumed toll income, companies invested little in improvements for the comfort of passengers. Travel was treacherous and tiring. In response, the territorial legislature required in 1862 that toll companies maintain their roads in good condition, with penalties for negligence.

Entrepreneurs and mining companies thus invested additional capital and man-power in their roads, improving main arteries. Builders used handtools and pack animals to construct cut-and-fill areas, to properly grade roadbeds, and move large rocks out of the way: "Road building in the mountains required expensive rock work to go over, around, and through the mountains. In some cases, shelves were blasted on mountainsides and cliff faces to carry the roads."⁵⁵⁰ Pavement, however, was far off in the future.

While wagons hauled most of the bulk freight into Clear Creek and Blue River drainages, stagecoaches were the principal carriers of parcels, mail, and passengers. Travelling at relatively high and constant speeds, stages exhausted their horses, which had to be changed every ten to fifteen miles. Thus, stage companies established swing stations where passengers could eat a quick meal and the driver could deliver and pick up mail.⁵⁵¹ Home stations were spaced every forty to fifty miles, and there, stages stopped for the night. In general,

...such places normally contained lodging and eating facilities, a ticket and postal office, store, barn with stable, and of course, staging equipment and livestock. Some home stations were located within towns, even within cities, and when this was the case the offices were housed in hotels, the horses and vehicles in livery stations.⁵⁵²

The stations were usually one story high with hewn log walls. The typical floorplan was square or rectilinear with a kitchen, dining room, and sleeping quarters, sometimes divided only by muslin draperies.⁵⁵³

In 1865, the territorial legislature began regulating the toll road business to further improve quality and foster transportation development. A bill authorized county commissions to fix toll rates and defined the distance between tolling stations as a minimum of ten miles.⁵⁵⁴ Typical tolls in the 1870s were:

Each vehicle with one span of horses, mules or cattle: \$1.00
 Each additional pair of draft animals attached: \$0.25
 Each horse or mule with rider: \$0.25
 Horses, mules, cattle or jackasses driven loose, per head: \$0.10
 Sheep, hogs, or goats, per head: \$0.05
 Travel for attendance at funerals: Free.⁵⁵⁵

⁵⁴⁸ Sprague, Marshall. *The Great Gates: The Story of the Rocky Mountain Passes*. Boston, MA: Little, Brown, and Company, 1964, 181.

⁵⁴⁹ Norman, 2002: 15.

⁵⁵⁰ Mehls, 1984, 59.

⁵⁵¹ Ubbelohde, et al., 2006, 66.

⁵⁵² Winther, Oscar. *The Transportation Frontier: Trans-Mississippi West 1865-1890*. Chicago, IL: Holt, Rinehart, and Winston, 1964, 67.

⁵⁵³ Winther, 1964: 67.

⁵⁵⁴ Stone, 1918, 576.

⁵⁵⁵ Ridgway, Arthur. "The Mission of Colorado Toll Roads." *Colorado Magazine*. (9/1932) 161-9.

Stagecoach companies thrived during the 1860s, due in large part to the growing system of roads. Wells, Fargo & Company controlled a great deal of the market because it strategically bought competitors and expanded its routes. By consolidating various stage companies, Wells, Fargo & Company provided freight, mail, and passenger service to Denver and Central City. In 1867, the outfit announced that it would extend service from Central City to Georgetown. Expressing confidence in its service, the company claimed that its coaches would arrive from Denver in Georgetown in only hours.

Promotion of Berthoud Pass among route finders stimulated road expansion in Clear Creek drainage. When the Civil War began in 1861, the Oregon Trail was one of the nation's principal east-west arteries crossing the Rocky Mountains at South Pass in Wyoming. Several stage and mail companies relied on the route to move goods between eastern states and western territories, including the Central Overland California & Pike's Peak Express Company (COC&PP). The federal government stationed several army units to keep the pass open and guard wagon trains against hostile outlaws and Native Americans. In need of reinforcements for its Civil War forces, the government redirected the units east. Native American tribes responded by temporarily closing the route. In response, the COC&PP searched for alternate passes, heeding William Byers' suggestion that passes west of Denver could provide east-west links. COC&PP hired Captain Edward Berthoud, intrepid frontiersman Jim Bridger, and an exploration party to search Clear Creek drainage. They were partially successful, locating Berthoud Pass as a key route into Middle Park and west to Salt Lake City. Ultimately, COC&PP decided against the route in favor of Bridger Pass, south of South Pass, because of gentler topography, fewer climbs, and open terrain. However, a wagon road was graded over Berthoud Pass in 1874, becoming a principal route to Winter and Middle parks.⁵⁵⁶ The road increased the Clear Creek system's importance, eventually becoming U.S. 40.

Local stagecoach companies helped foster a heavily used road network through demand, financial contributions, and sometimes construction. Below are a few of the stagecoach lines operating in and around Clear Creek drainage during the 1860s and 1870s. Individual timeframes of operation are not listed because of poor or obscure records.

- W.L. Smith serviced Caribou, Nederland, Boulder and Central City/Blackhawk.
- Colorado Stage Company operated between Blackhawk, Central City, Denver, Georgetown, Golden, and Idaho Springs.
- Kehler & Montgomery Express ran from Denver to Golden, up Golden Gate Canyon, to Central City.
- The Denver, Mt. Vernon, & Mountain City Express route provided service to Central City.
- Ben Holladay purchased the COC&PP in 1862 and changed the name to the Overland Stage Company. He staged between Denver and Central City, among other routes. He purchased the Butterfield Overland Dispatch in 1866, eliminating his most important competition on the Denver to Central City route.⁵⁵⁷
- The Middle Park Mail & Transportation Company Stageline passed through Empire on its way over Berthoud Pass from Georgetown to Middle Park.
- The Tovey Stageline ran from Georgetown to Middle Park.

⁵⁵⁶ *Colorado Miner* (11/7/74) p3 c3.

⁵⁵⁷ Scott, Glenn. *Historic Trail Map of the Denver Quadrangle, Central Colorado*. United States Geological Survey, 1999, 28.

- D.B. Casto (1859) express service between Denver and Central City.⁵⁵⁸
- Hinckley Express: service between Denver and Central City.
- Sowers & Company Mountain Express & Stage Company carried Hinckley and Company Express messengers to the mining camps.
- Western Stage Company provided mail service from Denver to Clear Creek mining towns, Boulder, and South Park.⁵⁵⁹

The basic road development pattern involving toll companies, stage and freight traffic, and combined efforts carried over into Summit County. Stage and freight companies began service to Breckenridge and neighboring Parkville in 1860 or 1861, primarily over passes in South Park. The quickest routes were pack trails crossing the Divide from Georgetown, the nearest commercial center, but were impassable to wagons. With discovery of silver at Montezuma near present Keystone during the mid-1860s, and continued placer mining at Breckenridge, several investors in Georgetown attempted to convert the pack trails into wagon roads. In 1867, local promoter Steven Decatur began building the Georgetown, Argentine & Snake River wagon road from Georgetown over Argentine Pass to Montezuma. His motivations were toll income and improved access to his Montezuma investments. At the same time, Joseph Watson organized the Georgetown & Breckenridge Wagon Road Company to grade a road from Georgetown to his Baker Mine in Grizzly Gulch, south of present Bakerville. Although Watson hoped to continue over Loveland Pass to Montezuma, he ran out of funds. But Decatur completed is road in 1869, increasing Georgetown' importance as a transportation center.⁵⁶⁰

Stage and freight traffic increased dramatically on the west side of the Divide during the late 1870s and early 1880s when Leadville boomed and mining in Summit County matured from placer to hardrock. Wagons hauled more freight than ever into the central mountains along improved arteries, distributing goods to remote towns and camps on primitive feeder roads. Quality roads were necessary, as typical freight included mining equipment and supplies, crates of food, domestic goods, and lumber. Again, toll companies, with stage and freight outfits, combined efforts to improve extant roads and build new ones. S.W. Nott Company stages, for example, traveled from Georgetown to Dillon, Frisco, Kokomo, and Leadville. In 1879, Nott constructed a stage road over Loveland Pass, down the Snake River, to Dillon to decrease travel time. Nott's stages then followed an existing road up Ten Mile Canyon to Wheeler, and over Fremont Pass to Leadville. The trip between Georgetown and Leadville was sixty miles and twelve hours over Loveland Pass, shorter than the route via South Park. After the railroads rendered Nott's stages obsolete by 1883, he abandoned the Loveland Pass Toll Road. Summit and Clear Creek counties later bought the road as a public highway, and although Clear Creek maintained its side, Summit County did not, and the road was soon was impassable to wagons.⁵⁶¹

Other stage lines operating through Summit County during the 1870s and 1880s include:

- Dave Braddock, linking Georgetown, Dillon, Breckenridge, Frisco, Kokomo and Recen in Ten Mile Canyon, and Como and Hamilton in South Park.
- Denver & Steamboat Springs stage company connecting Denver, Granby, Hot Sulphur Springs, Kremmling, Steamboat Springs, and Craig.

⁵⁵⁸ Norman, 2002: 21.

⁵⁵⁹ Scott, 1999, 29.

⁵⁶⁰ *Colorado Miner* (7/25/67) p3 c2; *Colorado Miner* (11/7/67) p4 c2.

⁵⁶¹ Scott, 2004: 31.

- Denver & South Park Stage Company operated from Denver to Fairplay, Breckenridge, and California Gulch.⁵⁶²
- Leadville & Ten Mile Express Company, serving Frisco, Wheeler, Kokomo, and Recen.
- Dan McLaughlin Stage Line, operated stages from Red Hill to Leadville beginning in 1880. A terminal station was built at Breckenridge, and the company carried passengers, freight, and gold shipments from there to Denver in 1862.
- The Colorado Stage Company, operated from Denver to Colorado Springs and Breckenridge three times a week.
- Spottswood & McClelland, linking Georgetown, Hot Sulphur Springs in Grand County, Kokomo and Recen in Ten Mile Canyon, and Como and Hamilton in South Park.
- Ten Mile Express & Stage Company, provided service to Ten Mile City, Carbonateville, and Kokomo in Summit County.⁵⁶³

Pack trails were by no means obsolete, and although not mentioned in archival sources, their total mileage increased from the 1860s through 1890s. This conclusion is logical given that remote mines and logging operations depended on freight service as much as those in transportation corridors, but many were unable to justify the cost of building wagon roads. Thus, they relied on caravans of pack animals instead, and graded trails for the traffic. Further, the number of such remote operations grew in Summit County with mining during the late 1870s and through the 1880s. Nearly all mining and logging communities featured systems of pack trails fanning to remote and otherwise difficult to reach properties. Some pack trails remained in use through the 1930s, after which mining declined and trucks replaced pack animals.

The Eagle and Colorado river valley lagged behind Clear Creek and Summit counties in road development by nearly twenty years. The region remained in possession of Ute tribes until 1880, when they ceded western Colorado under pressure from the federal government and settlers wanting natural resources. However, because the valley was remote, undeveloped, and lacked get-rich-quick resources such as gold and silver, settlement (and roads) evolved slowly.

Continued growth of industry and settlement in the corridor, and associated demand for freight and passenger service, became great enough by the 1870s to justify railroads. For example, estimates suggest that, in 1865, wagons hauled approximately 100 million pounds of freight to Colorado.⁵⁶⁴ Targeting Clear Creek drainage and its mining industry, the Colorado Central Railroad established a railhead near Idaho Springs in 1873 and completed a line to Georgetown in 1877. The Georgetown, Breckenridge & Leadville Railroad then pushed farther up the drainage to Graymont in 1884. The Denver & Rio Grande and Denver, South Park & Pacific graded lines through Summit County between 1881 and 1883. The Denver & Rio Grande also completed a track from Leadville down the Eagle and Colorado rivers to Glenwood Springs in 1887. Although these railroads carried most freight and passengers into and out of these regions, they did not negate the need for roads. Instead, the role of roads changed, now being used primarily for traffic between railroad stations and points of industry and population.

⁵⁶² Norman, 2002: 21.

⁵⁶³ Burke, Marril Lee. *A Bumpy Ride: A History of Stagecoaching in Colorado*. Lake City, CO: Western Reflections Publishing Company, 2007, 139; Scott, 2004: 30.

⁵⁶⁴ Ubbelohde, at al., 2006: 114.

Public Stewardship and the Good Roads Movement, 1893-1909

Local and trans-drainage roads came into public ownership in a wave spanning the 1890s through 1910s. The silver crash of 1893 altered the mountain economy and many toll companies no longer found the business profitable. Some companies mortgaged their roads, others abandoned them when the loan payments became too burdensome, and many lost title when the original charters expired. As key roads became available, county governments took them over, often with support from county commissioners. Once roads were under public ownership, the counties assumed responsibility for repairs, maintenance, and upgrades, paid for with taxes. For example, Clear Creek County assumed the Idaho & Floyd Hill Wagon Road in 1896.

During the same period, the national Good Roads Movement emerged, and was important in promoting a shift towards greater government involvement in road construction and maintenance. The Good Roads movement originated during the late nineteenth century among bicyclists in the eastern United States. Organized, the bicyclists demanded high-quality city streets and were ultimately successful in lobbying the federal government to take an active role in road planning. The U.S. Department of Agriculture established an Office of Road Inquiry in 1893, later renamed the Office of Public Roads. This was largely a symbolic victory, however. The agency lacked a strong mandate or funding, and functioned mainly as a clearinghouse, distributing information about best practices in road construction. After the turn-of-the-century, as automobiles became available, motorists joined the ranks of the Good Roads Movement and its calls for government participation in creating a new transportation infrastructure.⁵⁶⁵

With the responsibility for road improvements and extensions falling primarily on local governments, counties in the corridor began adopting contemporary engineering practices. Broadly, engineers recommended hard and smooth road surfaces, grading, road-building material such as crushed rock, and sophisticated machinery including horse-drawn scrapers and graders.⁵⁶⁶ The Office of Public Roads recommended drainage systems and roadway surfacing materials such as oil and bitumen, though these were not generally available in the high country. By the early twentieth century, surfacing scrapers, haul vehicles, steam rollers, and rock crushers were used for construction in urban areas. But the mountains were slow to benefit, and most construction was still done by hand and draft animal.⁵⁶⁷ Some road builders, however, started using crushed rock for macadam roadbeds. Developed for Scotland's wet conditions, macadam provided a firm, well-drained roadbed and surface. A layer of fractured cobbles formed the bed's base, providing drainage. Another layer of finely fractured gravel was graded over the cobbles, serving as the bed's upper portion. A mixture of dust and water was applied to the roadbed to fill in space between the rocks, forming a smooth surface.

As roads moved into the public domain, farsighted leaders understood their importance. In an attempt to connect remote western slope communities to Denver, State Senator Edward Taylor of Glenwood Springs petitioned State Legislature in 1899 to fund a continuous gravel road from Denver to Grand Junction via his district. Taylor was successful, and construction began that year. The state linked existing roads where it could, building new segments where necessary, completing the first automobile road through the Rocky Mountains in Colorado in 1902 (see Illustrations A 6.6 and 6.7). Known as Taylor State Road, the route started in Denver, traveled southwest to Buena Vista, followed the Arkansas River to Leadville, and crossed

⁵⁶⁵ Autabee 2003:E-19.

⁵⁶⁶ Winther, 1964: 157.

⁵⁶⁷ Winther, 1964: 157.

Tennessee Pass to Eagle River. The road passed through Red Cliff and continued along the Eagle to the Colorado River, following present-day U.S. 24. The road was supposed to parallel the Colorado to Glenwood Springs, but stopped at the mouth of Glenwood Canyon, a major obstacle. The project temporarily stalled as engineers pondered how to grade a road through the cliff-locked canyon. By this point, however, the road was partially successful because it provided a direct route linking Colorado River communities with Leadville and ultimately Denver. The only viable solution to complete the road was imitating the Denver & Rio Grande, blasting the roadbed from the canyon walls. The final segment through the canyon was finished within several years, bringing the total project cost to around \$60,000.⁵⁶⁸

The state's involvement in this project signaled the beginning of a pattern that would prevail in the years to come. Around the turn-of-the-century, state legislators began considering road construction more seriously, eventually being called upon to build a state network of roads. The transfer of responsibility for roads from the private sphere to the public coincided with other important transitions in the corridor. Mining, logging, and other natural resource industries waned in the mountains, with recreation and tourism gradually replacing them as an economic base. Originally, railroads brought tourists to the mountains, but around the turn-of the-century, tourists increasingly turned to automobiles for their scenic excursions and vacations. The nationwide shift to a transportation system focused on the automobile would ultimately make greater government participation and coordination inevitable.

Early Automobile Roads, 1910-1932

Early automobile owners were affluent and influential, and Colorado motorists organized a number of special-interest groups to promote road building and improvements, lobbying for more funding and a robust government role. Their interests were strongly tied to recreation, as scenic motoring grew in popularity in the exclusive world of auto enthusiasts, and a key priority for these affluent Denverites was access to scenic mountain routes. Their calls for more roads and improvements to existing routes dovetailed with the national Good Roads movement. In 1900, a Good Roads Convention was held in Denver. Delegates discussed ambitious projects including creating a highway from Denver over Berthoud Pass to Salt Lake City. Organizations such as the Denver Motor Club, established in 1908, and the Colorado Automobile Club, founded in 1902, grew out of this movement and were successful in capitalizing on broader calls for road improvements.⁵⁶⁹ In 1909, the clubs and their influential members convinced the Colorado General Assembly to establish the Colorado Highway Commission to further their cause.

Beginning in 1910, the Colorado Highway Commission was empowered to play a central role in planning and building state roads. Initially, because the Commission's original budget was a meager \$56,000, it was only able to survey existing roads and plan improvements. After driving the state's roads, the commissioners noted: "We found bridges we did not dare to cross in a car, encountered mud that stuck us, found grades we managed to crawl up at a speed a snail could beat, and roads that were never meant for anything but a horse-drawn vehicle."⁵⁷⁰ These descriptions made it clear that modern engineering techniques still had not been broadly

⁵⁶⁸ Schader, Conrad. *Glenwood Canyon: From Origin to Interstate*. Golden, CO: Regio Alta Publications, 1996, 124.

⁵⁶⁹ Autobe 2003:E-23.

⁵⁷⁰ Associated Cultural Resource Experts. 2002, 5-18; Fraser, 2000, E-25.

employed and that a substantial investment would be required to create a safe, reliable road network.

In 1913, the General Assembly restructured the Commission, which became the Highway Advisory Board, reporting to a Highway Commissioner appointed by the Governor. At the same time the legislature established procedures for registration and licensing of motor vehicles, which generated revenue for road projects, shared by the state and counties. During the 1910s additional measures designed to generate revenue for road construction were enacted, including a half-mill state tax in 1914 and a tax on gasoline in 1919.⁵⁷¹

Mirroring the process that unfolded at the state level, the federal government assumed a greater role in developing an automobile-based transportation system during the 1910s. Congress issued the Federal Aid Highway Act of 1916, guaranteeing matching federal funds for state highway construction. Though partly motivated by the Post Office Department's difficulty delivering mail to rural areas due to poor road conditions, pressure from an ever-growing number of motorists also catalyzed the legislation. Colorado responded by passing the Colorado Highway Act in 1917 to take advantage of the grant program. The legislation reconstituted the Highway Advisory Board once again, which became known as the Colorado Highway Department. In its new form it immediately organized its first six federal aid road projects: Denver-Littleton, Pueblo-Trinidad, Granite-Twin Lakes, Rifle-Meeker, Placerville-Norwood, Lamar-Springfield, but none within the I-70 corridor.⁵⁷² With the help of federal highway aid, Colorado's state road construction and maintenance budget increased from \$3 million during World War I, to \$10 million annually in the 1920s. Over that time period the number of cars registered in Colorado went from about 15,000 to 300,000.⁵⁷³

Building on the act of 1916, the Federal Highway Act of 1921 required that each state highway agency designate seven percent of total road mileage as primary roads and the remainder as a secondary network. The intent was to select strategic primary roads and tie them together as a new national highway system. Highway commissions in each state were responsible for construction and maintenance, and provided with federal funding to do so. To coordinate these and future highways into a national system, the Bureau of Public Roads designed a nationwide numbering system. Standardized highway markers replaced locally or regionally recognized highway shields in 1923.⁵⁷⁴

To qualify for federal funding programs, the Colorado Highway Department continually encouraged best practices in road construction methods and materials. The U.S. Bureau of Public Roads, established in 1918, outlined strict regulations for engineered roads and highways. The Colorado Highway Department primarily used gravel, stone, or shale for well-drained pavement up until the early 1920s. Gravel roads were constructed in two layers. A 2.5" base of stone formed the bottom layer with 3" of gravel constituting the top layer. A 300-pound road roller compacted the material to its final 3" thickness. During the 1920s, road construction shifted in favor of concrete. Conforming to Bureau of Public Roads regulations, all concrete pavements in Colorado had traverse joints every 30' and were laid on a 2" sand cushion. These roads had gravel shoulders 4' wide and 6" deep. Occasionally, sand was used for the shoulders.⁵⁷⁵ In terms of road footprint, the agency not only provided ample width for oncoming vehicles to pass, but

⁵⁷¹ Autabee 2003:E-5.

⁵⁷² Autabee, 2003: E-29.

⁵⁷³ Abbot 2000:239.

⁵⁷⁴ Autabee, 2003: E-71; Koucherik, 2009: www.museumwco.org.

⁵⁷⁵ Autabee, 2003: E-55-6.

also construction of additional lanes in the future. “For graded and paved roads, the state demanded a 60’ wide right-of-way to accommodate a 24’ wide road.”⁵⁷⁶ Particularly crucial in the mountains, the Bureau of Public Roads, established regulations regarding grade limits and road curvature. Grades could be to no more than six percent and curve radii no less than 100’. But this was not viable in narrow canyons, so the Bureau recommended radii of no less than 40’ in such conditions.⁵⁷⁷

During the 1910s, the state’s focus was on connecting agricultural areas on the plains to markets such as Denver and Colorado Springs. Mountain roads were far more costly and complex, and such projects were largely deferred by the state Highway Department until the 1920s when additional funding became available through federal programs. Nonetheless, a few early road improvements in the corridor undertaken primarily by local governments are of note. Clear Creek County worked over several decades to improve the road between Floyd Hill and Idaho Springs. In 1907, engineers reconstructed the road to climb an eleven percent grade, with a short thirteen percent segment near the hill base. In 1916, the surface was widened, and the next year the county added guard rails where necessary. The original route remained the same, but newer road-building techniques and design standards were implemented for greater safety and traffic efficiency.

Taylor State Road was the only alternative route to Glenwood Springs from Denver via auto, other than over Berthoud Pass to Hot Sulphur Springs (now U.S. 40). Because the road was narrow, rough in places, and slow even when finished, it was subject to improvements as funds became available (see Illustration A 6.8). When the Colorado Highway Commission formed in 1910, it designated the route State Primary Road 10, making it eligible for improvement grants. To encourage tourism and codify the road as the most direct highway through the central mountains, the federal government designated it as part of the Pike’s Peak Ocean to Ocean highway in 1914. Various sections were widened afterward, and the entire highway was surfaced with gravel and oil in 1923.

Denver Mountain Parks, a subsidiary of Denver city government, also played a role in the expansion of Clear Creek drainage’s growing road network during the 1910s. Recreational auto touring was the major impetus behind the road construction. Denver officials valued the natural environment, its watersheds, and income from tourism, and began purchasing land in Jefferson and Clear Creek counties to secure all three. Playing on Colorado’s natural beauty, Denver Mountain Parks defined a system of alpine parks and scenic points linked by auto parkways (see Illustration A 6.4).⁵⁷⁸ Genesee Park was the first destination established under this system in 1913, accessed via the Lariat Trail up Lookout Mountain and Mount Vernon Canyon (today’s U.S. 40), which continued to Bergen Park, Floyd Hill, and Idaho Springs. In 1915, Denver Mountain Parks announced even loftier goals in its auto tourism program and planned a road to the summit of Mt. Evans. But construction of the tortuous, 6½ percent, gravel road was delayed until 1924, finally opening in 1927 as the highest auto route in the United States.⁵⁷⁹

The road over Loveland Pass, constructed by S.W. Nott Company in 1879 to access Summit County mining districts, was used by wagons in the 1910s but impassable by autos and trucks. By 1920, automobile owners and Clear Creek County convinced the state Highway Department to improve the eastern portion, leaving the western side in its original condition. The

⁵⁷⁶ Autobee, 2003: E-53.

⁵⁷⁷ Autobee, 2003: E-54.

⁵⁷⁸ Norman, 2002: 37.

⁵⁷⁹ Autobee 2003:E-26, 32.

road was further improved and widened by the Highway Department in 1932, remaining unpaved.⁵⁸⁰

Clear Creek drainage also became an important link in one of the earliest auto-worthy roads to cross the central mountains. In 1922, the State Highway Department announced that it planned to improve heavily used roads of military value. Included was today's U.S. 40 from Denver to Idaho Springs, up Clear Creek to Empire, and over Berthoud Pass to Granby, Steamboat Springs, Craig, and into Utah. The road, a favorite among scenic motorists from Denver, became known as the Grand Valley and Hot Springs Scenic Route. In 1925, the route was included in the original group of coast-to-coast roads designated by the federal government as the national highway system. The road was officially numbered route U.S. 40 and also known as the Victory Highway. As a national highway, U.S. 40 was eligible for federal aid and was the only road in the state, west of Denver, qualifying for such funding during the 1920s. As a result, U.S. 40 was the best-maintained road in the Colorado high country through the 1920s and 1930s. By the late 1930s, it was paved or oiled along its entire length.⁵⁸¹

From the New Deal to the Interstate Era, 1933-1962

The New Deal programs of the Great Depression brought some of the most profound changes to Colorado's road infrastructure. The Public Works Administration (PWA) and Works Progress Administration (WPA) improved key arteries and built several thousand miles of new roads and bridges. Between 1933 and 1942, the WPA alone constructed or improved over 9,400 miles of highways, roads, and streets; 3,400 bridges or viaducts; and 21,000 culverts in Colorado. Most of this work was supervised by professional engineers who considered drainage, safety, retaining structures, and surfacing materials as fundamental elements in roadway construction.⁵⁸² By the 1930s, asphalt was the road surface of choice. Colorado adhered to the engineering and construction standards laid out by the American Association of State Highway Officials in their *Policy on Geometric Design of Highways and Streets*, known as the Green Book.⁵⁸³

Clear Creek County underwent one of its greatest periods of road development during the Great Depression. State highway engineer Charles Vail began a prolonged improvement campaign, focusing on resurfacing gravel roads. Although concrete and asphalt were used for important arteries, the agency coated most roads with oil (a plentiful local and inexpensive resource) to form a uniform surface. There were only 533 miles of paved roads in Colorado in 1930, but by 1941, the total was 4,200 miles. Clear Creek drainage directly benefitted from WPA efforts as U.S. 40 was improved between Denver and Idaho Springs.⁵⁸⁴ In 1938, the Colorado Highway Department took ownership over abandoned railroad alignments with the intent of adding them to the 4,440 miles of state highways.⁵⁸⁵ This included the Colorado Central Railroad grade between Clear Creek and Georgetown, which was converted into State Highway 103.

⁵⁸⁰ Wiley, Marion. *The High Road*. Denver, CO: Colorado Department of Highways, 1976, 26-7.

⁵⁸¹ Colorado State Highway Commission. *Colorado Highways*. (5/1922), 8; Philpott, William. *Consuming Colorado: Landscapes, Leisure, and the Tourist Way of Life*. Ph.D. Dissertation, University of Wisconsin at Madison, 2002, 183-4.

⁵⁸² Office of Archaeology and Historic Preservation. *The New Deal in Colorado 1933-1942: Properties Listed in the National Register of Historic Places or the Colorado State Register*. Denver, CO: Colorado Historical Society, 2008, 24.

⁵⁸³ Autabee 2003:E-59.

⁵⁸⁴ Autabee, 2003: E-67; Norman, 2002: 39.

⁵⁸⁵ Autabee, 2003: E-16.

Taylor State Road, designated by the federal government as U.S. 24 in 1935, was the focus of most highway work in the Eagle and Colorado river valley during the Great Depression. The WPA began by paving sections between Leadville and Eagle before turning its attention to Glenwood Canyon. There, the road was still a narrow and winding shelf along the base of sheer cliffs. The highway was often closed while workers widened and paved. They finished improvements in 1938 after investing \$1.5 million, making western Colorado more accessible to trucks, buses, and auto tourists (see Illustration A 6.9).⁵⁸⁶

Although U.S. 24 greatly improved travel from Denver into the Colorado River valley and Glenwood Springs, the route was still tortuously slow. The federal and state government sought a more direct alternative, deciding in 1937 to extend U.S. 6 from the plains into the mountains through Clear Creek, Summit, and Eagle counties. The newly-designated route U.S. 6 was therefore eligible for federal aid funding. In Clear Creek County, the new highway doubled as U.S. 40 to Empire, continuing west up Clear Creek to Loveland Pass. The Summit County side, still unimproved, impeded auto traffic, but U.S. 6 carried vehicles from Dillon up Ten Mile Canyon. With federal funding, U.S. 6 was extended from Ten Mile Canyon west to Minturn, joining U.S. 24. In 1939, the PWA began grading a direct route for U.S. 6 from Wheeler in Ten Mile Canyon, west over the Gore Range, and northwest down Gore Creek to Minturn. The new section became known as Vail Pass, named after State Highway Engineer Charles Vail.⁵⁸⁷ In 1940, construction crews joined the new highway with U.S. 24, further contracting travel time from Denver. As a result, Eagle County saw greater numbers of tourists with the highway subsequently encouraging development of the ski industry.

During World War II, shortages in labor, equipment, and materials stalled road projects. In the 1940s, Colorado's average highway revenue per vehicle declined markedly, ranking it forty-third among states in available highway funding.⁵⁸⁸ The affluence of the postwar years, however, brought a boom in road construction as the state Highway Department worked to catch up on years of deferred maintenance. On U.S. 6, the unimproved west side of the old Loveland Pass wagon road was finally widened and paved in 1950, opening Summit County to more tourism. Another U.S. 6 project completed after the war involved improving the road from Golden up Clear Creek Canyon to Idaho Springs, providing greater access to the mountains. The section, with numerous cuts, fills, and tunnels, opened in 1952.⁵⁸⁹

More federal legislation affected Colorado's highway network during the 1950s, especially in the high country. President Dwight D. Eisenhower understood that a well-planned system of professionally built highways was a key factor in Germany's successful mobilization during World War II. He was also haunted by the Great Depression and proactively sought to avoid a serious economic downturn during his tenure. He thus perceived development of the country's road infrastructure as an economic stimulus program, mirroring the public works programs of the New Deal, and advanced the idea of a modern national road network. His administration championed the Federal Highway Act of 1956. But instead of the conventional highways built up to that time, the Act commissioned a system of high-speed, multi-lane interstate roads designed for high volumes of traffic and long-term use. The Act created a Highway Trust Fund and specified that federal dollars would cover ninety percent of construction costs. Colorado would host east-west Interstate-70, linking Washington D.C. with

⁵⁸⁶ Schader, 1996: 133-134.

⁵⁸⁷ Autabee, 2003: E-36. Wiley 1976:26-7.

⁵⁸⁸ Autabee 2003:E-37.

⁵⁸⁹ Associated Cultural Resource Experts, 2002: 7-3, 7; Norman, 2002: 40.

Denver, but proceeding no farther because the Rocky Mountains were an obstacle for a through highway.⁵⁹⁰

Despite this, Colorado legislators, government officials and business leaders lobbied aggressively to extend I-70 through the high country. They offered many justifications. The interstate would facilitate access to vital resources including minerals, timber, and water. The route would also be strategic for national defense, connecting military installations with uranium and fossil fuel reserves. Tourism was also a major factor, as many communities west of the Divide equated improved roads with increased tourism revenue. Governor Edwin C. Johnson pledged that Colorado would build a tunnel under the Continental Divide if the Interstate was routed over the mountains. Eisenhower himself supported extending I-70, and he influenced Congressional approval of funding in 1957. The precise route through the high country from Denver to Utah was, however, undecided. Proponents of U.S. 40 aggressively debated advocates of U.S. 6, each with strong interests. Ultimately, a route following U.S. 6 was selected in 1960.⁵⁹¹

Instead of paving the interstate in one direction, end to end, the Federal Highway Administration contracted specific segments at different times. Thus, development was disjointed, with high mountain segments taking the longest, as expected. Contractors completed the portion along Clear Creek in segments, Floyd Hill to Idaho Springs in 1961, to Silver Plume in 1968, to the Eisenhower Tunnel by 1972.⁵⁹² Charles Shumate, State Highway Engineer at the time, oversaw construction of the Eisenhower Tunnel by the Straight Creek Constructors consortium beginning in 1968. Despite landslides, rock fall, and cave-ins during construction, he opened the tunnel to two-way traffic in 1973 (see Illustration A 6.5). Peter Kiewit Sons Company and Brown and Root began construction of the Johnson bore in 1975 and finished in 1979. The Johnson bore was designated for eastbound traffic and the Eisenhower bore for westbound. Completion was of enormous benefit to mountain communities west of the Divide, because it made them more accessible for recreation than ever before.⁵⁹³

When the Federal Highway Administration planned I-70 west from Summit County, it had difficulty finding a suitable, cost-effective route due to tight canyons, steep grades, and high passes in the central mountains. One option was to curve far north around the highest peaks, and the other was to parallel U.S. 6 along Gore Creek. The administration ultimately chose U.S. 6 when the Secretary of Agriculture denied an easement through the northern reaches of White River National Forest, and when that route's construction projected costs were three times higher. Thus, the administration routed I-70 over Vail Pass and down the Eagle and Colorado rivers in 1978, encountering the same impediment that stalled the Taylor State Road. Glenwood Canyon was simply not wide enough for a four-lane interstate with median, accomplished by conventional blasting and fills. Thus, Colorado Department of Transportation (CDOT) and the Federal Highway Administration used the project as an opportunity to innovate best practice in construction and design. Construction occurred between 1981 and 1992, yielding an engineering success in a canyon that historically vexed road builders. The highway, built directly atop Taylor State Road, was double-decked with each set of lanes supported on its own distinct concrete structure. The roadway design was intended to be slender and visually distinct from the canyon.

⁵⁹⁰ Lewis, Tom. *Divided Highways: Building the Interstate Highways, Transforming American Life*. New York, NY: Penguin, 1997, 86, 121.

⁵⁹¹ Autabee 2003:42; Philpott 2002:193-6.

⁵⁹² Associated Cultural Resource Experts, 2002: 7-9.

⁵⁹³ Autabee, 2003: 43-45.

The contrast defined the interstate as separate while highlighting the beauty of the canyon. In so doing, the Glenwood Canyon section showcased context-sensitive highway engineering.⁵⁹⁴

⁵⁹⁴ Associated Cultural Resource Experts, 2002: 11-71; Autobee 2003:50.

Section A 7: History of Tourism and Recreation, 1860-1962

Introduction

The history of tourism and recreation in the I-70 Mountain Corridor can best be understood in context of broad economic shifts from traditional resource-based activities to mass consumerism. Before World War II, the area saw limited tourism because of competition from more accessible regions. And yet, by the 1970s the corridor became known across the country and beyond as a desirable destination for remarkable scenery, skiing, fishing, hiking, camping, hunting, and other outdoor pursuits. Broad national factors contributing to this transformation include postwar affluence, availability of automobile and air travel, and desire of middle-class Americans to escape from everyday urban life through uplifting outdoor activities. A key element in the evolution of high country tourism and recreation involved a fundamental shift in perception, where the corridor was no longer viewed primarily as the site of resource extraction and agricultural production, but as a landscape of leisure that could be packaged, marketed, and consumed.⁵⁹⁵

Although the I-70 corridor had been a destination amongst vacationers since the early 1860s when miners first opened the region, the character and level of leisure activities changed dramatically following World War II. This was chiefly due to the expansion and improvement of facilities, infrastructure, and transportation, notably roads. Focused marketing and promotional efforts also played an important part in positioning recreation as a key sector in the mountain economy. Promoters included business and civic leaders, recreational interest groups, and local and state agencies seeking economic revitalization following decades of stagnation between the collapse of mining in 1920 and end of World War II.

Proximity to Denver, a western city on the rise, was also important, as the business and recreational interests of affluent Denverites strongly influenced leisure development in the high country. Denverites were drawn to the corridor for excursions and entertainment almost as soon as railroads provided access in 1877, though these were generally sightseeing day trips rather than the extended resort stays of tourists who came from afar. As automobiles became more available in the 1910s and 1920s, scenic motoring became popular among Denverites who were drawn to the mountain landscape. Unimproved roads, however, limited their range. During the 1930s and 1940s, Denverites began purchasing vacation homes in the corridor, continuing to influence recreation activities and services.⁵⁹⁶

As discussed in detail above in Section A 6: History of Roads, after World War II the shift towards centralized planning and building of road networks transformed the American landscape and had profound effects on the culture as a whole. Recreation and vacation by automobile became prevalent and the road trip emerged as a mainstay of American tourism. In the corridor, recreation interests were key players in lobbying efforts that ultimately succeeded in routing I-70 through the mountains, positioning tourism as a vital economic sector for the region.

This section discusses activities that left a tangible imprint on the landscape, including skiing, resorts, fishing, hunting, hiking, and camping. The evolution of these activities in the corridor over the Period of Significance fundamentally shaped the region's current image as a landscape of adventure, renewal, and play.

⁵⁹⁵ Philpott, William. *Consuming Colorado: Landscapes, Leisure, and the Tourist Way of Life*. 2002. Ph.D. Dissertation, University of Wisconsin at Madison, 9-12.

⁵⁹⁶ Philpott 2002: 28.

Period of Significance, 1860-1962

The Period began in 1860 when gold miners in western Clear Creek drainage began skiing as transportation. Miners, loggers, and other settlers carried the practice west into the Blue River and Ten Mile Canyon area in 1878, and into the Eagle and Colorado river valley by 1887. During this time and the subsequent several decades, skiing gradually evolved into a recreational activity. Resort tourism started in the region in Idaho Springs in 1865, initially catering to an elite clientele whose tastes were influenced by European and Eastern sensibilities. By the 1890s elite preferences began to shift in keeping with emerging anti-modern attitudes. Concerns about the ills of industrialization and urbanization surfaced and a new, specifically American identity emerged, linked to images of the frontier and wilderness in contrast to effete European culture. Teddy Roosevelt was perhaps the best exemplar of this bold, new identity. Ideas of leisure and recreation shifted towards more vigorous pursuits like hunting, fishing, camping, and skiing.⁵⁹⁷

Resort tourism declined during the 1920s as a result of shifting tastes and decreasing rail access. At the same time, more active recreational pursuits increased in popularity as automobiles became available and roads improved. The post-World War II period saw a boost in leisure as a whole, as war-weary Americans were eager to take vacations and enjoy peacetime affluence. During the decades following the war there was an enormous expansion in tourism and recreation in the high country, with the development of a robust ski industry as the dominant element. The Period of Significance ends in 1962, fifty years before this report was produced, with the opening of Vail, a fully-planned concept resort that epitomizes the transformation of recreation into a carefully packaged consumer experience made possible by the Interstate era. Vail and other ski areas less than fifty years old may qualify for nomination under a later Period of Significance as time passes and this context is updated. They can also be evaluated under NRHP Criterion Consideration G, recognizing exceptionally important properties that achieved significance within the last fifty years.

The Areas of Significance applicable to recreation and tourism in the corridor include: Architecture, Commerce, Conservation, Economics, Engineering, Entertainment/Recreation, Industry, Landscape Architecture, and Politics/Government. The level of significance is likely to be local, although some resources could be statewide, depending on further research.

Skiing

Skiing began in Clear Creek drainage in 1860 when miners used crude, custom-made planks for winter transportation. At first the activity was primarily practical, but gradually evolved into a form of recreation, completing the transition during the 1930s. Before World War II there were two basic groups of recreational skiers: residents of mountain towns who enjoyed the activity, and affluent, sports-minded Denverites who could afford to travel to the corridor for recreation. These groups created primitive ski areas with very basic facilities such as warming huts and tow ropes. In 1943, the U.S. Army established the Tenth Mountain Division, whose members were trained in skiing and mountaineering and based near Leadville. After World War II, many veterans of the Division returned to settle in the area and were instrumental in working with local skiers and Denver enthusiasts to create additional ski areas and eventually resorts. The postwar period saw the introduction of important new equipment and facilities, as well as

⁵⁹⁷ Lears, J. Jackson. *No Place of Grace: Antimodernism and the Transformation of American Culture, 1880-1920*. Chicago, IL: University of Chicago Press, 1994; Rothman, Hal K. *Devil's Bargains: Tourism in the Twentieth-Century American West*. Lawrence, Kansas: University Press of Kansas, 1998.

improved road access, which opened up skiing to mass-market tourism. Recreational skiing is a prominent aspect of the region's economic foundation today.

Scenic Tourism & Resorts

Tourists came to Colorado as early as the 1860s, but their numbers in the corridor were few because overland stagecoach was the only means of travel. Railroads improved access to the high country beginning in 1877, and more affluent tourists made the journey from the East. A number of resorts catering to an elite clientele developed in the corridor, modeled after similar destinations in the East such as Saratoga and Carlsbad. Following the European and Eastern fashions of the time, beautiful scenery, fresh air, and curative mineral waters as well as a sense of exclusivity and sophistication attracted tourists. Because of their remoteness, the resorts in the corridor never quite attained the size and status of similar destinations elsewhere in the state (e.g. Colorado Springs and Manitou Springs). Affluent Denverites also participated in the Victorian practice of scenic sightseeing, traveling by rail to mountain towns to enjoy the same landscapes and diversions as tourists. Resort tourism declined in the corridor beginning in the 1920s due to changing vacation preferences and declining rail service.

As automobiles became available during the 1910s and 1920s, scenic motoring emerged as a popular pastime. Enthusiastic Denverites continued to be drawn to the high country's spectacular vistas, though they were limited by the poor road conditions of the time. By the 1930s, influential Denverites began reviving mountain towns, funding historic preservation efforts such as restoration of Central City's Opera House and Georgetown's quaint Victorian buildings. Interest in mountain town heritage increased after World War II, driven by the rise of mass tourism and a national fascination with the old west. For example, tourists on road trip vacations often included sightseeing stops at old mines and ghost towns in their itineraries. Facilities catering to tourists seeking heritage experiences became common in the 1940s and 1950s, and are still visible in the corridor today.

Outdoor Recreation

Outdoor activities such as hunting, camping, hiking, and fishing had been an integral part of life for prospectors, miners, loggers, and settlers from the 1860s on. While these were generally subsistence activities up until the end of the nineteenth century, broad shifts in American cultural sensibilities ultimately transformed the outdoors into an arena for leisure and adventure. Hunting and fishing expeditions enabled affluent men direct connections with the country's frontier heritage, and activities like picnicking and hiking allowed participants to interact with the spectacular scenery instead of just observe it. Automobiles provided independent access to the outdoors and greater opportunity to enjoy active pursuit.

HISTORY OF SKIING

Evolution of Skiing as Recreation, 1860-1934

Miners introduced skiing to Colorado, many having migrated from Scandinavia and northern Europe, where skiing was widely practiced as winter transportation. When the Rocky Mountains presented immigrants with familiar winter conditions, they continued this important cultural tradition. In challenging snowy conditions, skiing was often the only practical

transportation for miners. For example, in the winter of 1871, miners from Montezuma camp skied to Denver and back to restock supplies. Other settlers emulated the miners out of necessity, adopting what were referred to at the time as Norwegian snowshoes. Use by mail carriers was common and there are accounts of skis being used by ministers like John Dyer, cowboys retrieving lost calves, and even by doctors and midwives. Early wooden skis were 8' to 12' long, 5" wide, and 1" thick, with tips steamed and curled upwards. The ski attached via a strap while the skier used a single long pole for balance and stopping.⁵⁹⁸

Skiing began transitioning from transportation to recreation during the 1880s due to changes in regional development and demography. Mountain towns were finally connected with the outside world by road networks and railroads, and town residents no longer had to rely on skiing for mobility. But individuals living outside of towns, loggers and miners, still skied out of necessity. The tradition persisted as part of mountain culture as a result. With free time and an interest in leisure during winters, mountain town residents turned to skiing for recreation. Communities organized ski clubs and hosted related events such as dances, parties, and outings. Competitive ski racing and jumping began in the 1880s where the earliest account of a ski race in Colorado was one held in 1883 at Irwin, hosted by a ski club organized by miners of the Star Mine, both in Gunnison County. Races were both entertainment for participants and spectators, and competition for cash prizes between neighboring communities. The result was closer ties within and between mountain communities.⁵⁹⁹

Northern European immigrants also fostered skiing's evolution as a recreational activity around the turn of the century. Immigrants brought new types of skis with bindings that attached to the heel, providing the user with greater maneuverability. During the same time period, Norwegians promoted ski competitions and winter carnivals. Among them were Fridtjof Nansen and Sondre Nordheim, both avid skiers who emphasized the social aspects, health benefits, and opportunity to temporarily escape indoor life. These developments furthered skiing as a sport by making it easier and more attractive to a greater number of people.

Peter Prestrud, a Norwegian immigrant, was among the earliest to popularize skiing as sport in Summit County. He ran a store in Frisco during its 1900 boom and found that winters there provided ample snow. Prestrud and friend Eyvind Flood built a ski jump at the Excelsior Mill in 1911, as well as other jumps around Frisco in subsequent years. Their events were locally important, but celebrations in communities to the north had even greater impact. Hot Sulphur Springs hosted Colorado's first winter carnival and ski competition in 1912. Norwegian immigrant and skiing circus daredevil Carl Howelson, also known as the Flying Norseman, began the annual winter carnival tradition at Steamboat Springs in 1914. The carnivals included sledding, skating, ski competitions, and women-only contests. Similar carnivals spread throughout the central mountains as participants organized events in their communities.⁶⁰⁰

Due in large part to Prestrud and Flood, Frisco began hosting the annual Winter Sports Carnival, one of the most important regional ski events. In 1919, they built Summit County's largest jump to date at Dillon in preparation for a significant competition. Youths from throughout the county tested their skills, while Norwegian jumper Anders Haugen set a world distance record. Prestrud and Flood continued to promote both traditional cross-country and new

⁵⁹⁸ Baker, Gayle. *Denver: A Boomtown History*. Santa Barbara, CO: Harbor Town Histories, 2004, 12; Coleman, Annie Gilbert. *Ski Style: Sport and Culture in the Rockies*. Lawrence, KS: University Press of Kansas, 2004, 19, 21, 26; Fay, Abbott. *A History of Skiing in Colorado*. Ouray, CO: Western Reflections, 2000, 7, 9, 15, 19.

⁵⁹⁹ Coleman 2004:22, 24-25; Fay 2000:17-18.

⁶⁰⁰ Gilliland, Mary Ellen. *Frisco! A Colorful Colorado Community*. Silverthorne, CO: Alpenrose Press, 1984, 76; Coleman 2004:27, 28, 32, 36, 65; Fay 2000:23.

but increasingly popular downhill skiing. They organized children's competitions, youth ski classes, and the Summit Cup ski jump contest.⁶⁰¹

Beyond the mountain towns, Denver was also a source of ski enthusiasts who organized outings and established clubs. In 1912, Denver area interests established the Colorado Mountain Club (CMC) for the preservation of scenery and wilderness, exercise and outdoor recreation, and tourism. The club embraced skiing within three years and made regular winter trips to Brook Forest, Chicago Lake, Homewood Park, and Estes Park. CMC built a ski center including a ski jump at Genesee Mountain in 1919, which hosted a national professional ski meet next year. During the 1920s, residents in Colorado Springs, Boulder, and Estes Park organized their own local CMC chapters. Carl Howelson and a group of Norwegian immigrants founded the Denver Ski Club in 1913 and the Rocky Mountain Ski Club the following year to organize spectator events and promote the sport. In 1927, Graeme McGowan, founder of the Arlberg Club, remodeled cabins used in the construction of the Moffat Tunnel, Boulder County, into housing for club members. The club pioneered ski runs that eventually became the Winter Park ski area.⁶⁰²

Development of Resort Skiing, 1935-1944

In Europe, where skiing began, the sport underwent another transition approaching today's Alpine style. During the 1920s, European elite claimed the sport as their winter leisure activity and stayed in resorts specifically designed for downhill skiing. Equipment improved, with shorter skis and two poles replacing the long rod previously used. European ski instructors brought these concepts, equipment, and skills to the northeastern United States. The instructors' charisma, the sport's strong association with European sophistication, and reports of new destinations began interesting affluent American youth. The movement became a foundation of ski culture, which trickled into Colorado during the 1930s. The emerging ski culture valued skill and character-building stamina on the mountain, socializing and leisure off the mountain, and a close relationship with winter.⁶⁰³

Energized, Colorado's recreational organizations promoted the creation of formal ski areas in the Front Range, within easy reach of Denver. CMC and ski organizations including the Arlberg Club, the Denver Ski Club, and the Zipfelberger Club identified sites and built facilities, with the U.S. Forest Service supporting their efforts by issuing needed permits. Along with many other recreation projects during the 1930s, the Civilian Conservation Corps (CCC), Works Progress Administration (WPA), and Public Works Administration (PWA) provided labor and some funding to ski area construction. These collaborative efforts produced four ski areas within or near the I-70 corridor, and a few more elsewhere in Colorado (including Steamboat Springs, Glenwood Springs, and Climax). Even though the state suffered in the dismal economic climate of the Great Depression, the popularity of skiing increased because it was inexpensive, requiring only a shared auto and money for fuel and food.⁶⁰⁴

Echo Lake, first among the new areas, opened less than ten miles southwest of Idaho Springs in 1935. The destination was primitive, consisting largely of tight ski runs, a parking area, and warming hut. A permanent lodge or other facilities were absent. In 1936, ski organizations and government agencies completed Berthoud Pass ski area north of Empire. The

⁶⁰¹ Gilliland 1984:76, 79, 83.

⁶⁰² Coleman 2004:30, 34-35; Fay 2000: 31-33.

⁶⁰³ E. John B. Allen. *From Skisport to Skiing: One Hundred Years of an American Sport, 1840-1940*. Amherst, MA: University of Massachusetts Press, 1993.

⁶⁰⁴ Philpott 2002: 278

consortium cut trails and graded parking areas. With financing from the May Company (a department store in Denver that sold ski equipment), one of the state's earliest tow ropes was installed at Berthoud Pass in 1937. Also called ski tows, these apparatuses facilitated the growing industry because they made long slopes accessible to more participants. A tow simply consisted of a rope loop, pulleys at the slope base and top, and an engine, usually salvaged from an automobile. Skiers either held handles or used seats as the rope dragged them, sometimes literally, to the top of a run. Special ski buses supplemented trains to the area to accommodate the growing number of skiers. In the winter of 1938-1939, the ski patrol at Berthoud Pass recorded 50,000 skier days (an increase of 20,000 over the previous year).⁶⁰⁵

Loveland ski area, described in more detail below, also opened in 1936 but had difficulty at first due to construction on Loveland Pass road. The Zipfelberger Club led by Thor C. Grosword (who started a ski factory in Denver in the mid-1930s) and J.C. Blickensderfer, built a lodge and set up a portable tow rope on the east side of the pass, while Allen Bennett installed his own tow rope powered by a Model-T engine. When the road was completed in 1938, area use soared. The Club subsequently established Porcupine Gulch ski area on the west side of the pass, which may have been the simplest, with a portable tow rope and no facilities.⁶⁰⁶

The creation of Winter Park ski area is also notable because of the strong involvement of the City of Denver and the coordination between New Deal agencies in construction and funding. In 1938, Denver Parks and Improvements Manager George Cranmer developed a plan to create Winter Park as part of the Denver Mountain Parks system. PWA provided funds to supplement city funds and private donations, totaling \$50,000 for the project. City workers volunteered their weekends to clear the slopes and CCC and Forest Service provided additional labor. Special trains serving Winter Park ran from Denver and an important ski school was established to introduce young Denverites to the sport.⁶⁰⁷

United States' entry into World War II at the end of 1941 arrested progress in the nascent ski industry. Youth, the sport's principal demographic, either went to war or into supporting industries. Gasoline rationing and a moratorium on new automobiles discouraged commuting into the mountains. Ski organizations also had difficulty securing labor, capital, and partnerships for more resort development. World War II did, however, produce the human capital that shaped skiing into its current form. In 1943, the United States Army established the Tenth Mountain Division for specialty work in Europe's rugged terrain, easily attracting young men already versed in skiing and mountaineering. Those training at Camp Hale, west of Leadville, became intimate with Colorado's central mountains, and many settled there upon discharge. Former Camp Hale soldiers who were outdoorsmen by interest and training, gave new life to the industry. After the war, Tenth Mountain veterans were involved in opening or managing over a half dozen ski areas in Colorado, including Loveland Basin and Vail in the I-70 corridor.⁶⁰⁸

Growth of Ski Tourism, 1945 to 1962

After World War II ended, a number of factors helped the ski industry expand and flourish. People sought leisure and had resources to pursue entertainment, after going without during the Great Depression and war. Youth were less inhibited than previous generations in embracing difficult physical recreation. Automobiles were widely available and government agencies drastically improved Colorado's road network during the late 1940s and 1950s, making

⁶⁰⁵ Coleman 2004:90-91. Fay 2000:36-41.

⁶⁰⁶ Colorado Ski History. *Colorado's Lost Resorts*. July 7, 2009, <http://www.coloradoskihistory.com/lostresorts.html>; Fay 2000:39-40.

⁶⁰⁷ Fay 2000:43,80.

⁶⁰⁸ Coleman 2004:8, 97-98, 100, 106-107.

the mountains easily accessible. When the federal government began its interstate program in 1956 and air travel became affordable around the same time, vacationers from outside of Colorado also found ski areas to be within reach.

Beyond postwar affluence and the greater mobility created by improvements in road networks (see Section A 6: History of Roads for details) the ski industry also benefited from focused marketing and promotion efforts that were part of a broader push to increase tourism in Colorado. Business and civic leaders, outdoor recreation clubs, and government agencies all worked in parallel, and at times in competition, to boost tourism to the high country, but there were also coordinated efforts. For example, in 1945 the Denver Chamber of Commerce organized the Colorado Winter Sports Congress, a gathering to develop a common vision and strategy to position winter sports as a key economic asset for the state. The convention was attended by business leaders and promoters, ski clubs, equipment manufacturers, railroads, department stores, ski shop owners, college athletic departments, U.S. Forest Service staff, and members of the media. One of the outcomes was the formation of a Winter Sports Committee that conducted a statewide survey of potential ski areas with input from the Forest Service. As important as coordinated planning and promotion, industry experts redefined the ski area concept, obtained capital, and began building complexes similar to those in Europe. Before the war, ski areas were simple, small, and offered few amenities for those not actively skiing. Lodges, also known as warming huts, were crude, built as needed with available materials, and offered no services. Bathrooms were usually privies. On the mountain, runs were tight and tortuous, tow ropes were uncommon, and skiers often walked to the top.⁶⁰⁹

After the war, Tenth Mountain veterans and other ski area developers invested capital in improvements to make skiing more appealing and convenient. Their companies built lodges with food service, bathrooms, waiting areas, and parking lots. Experts adapted existing forms of machinery and even invented new equipment and methods to improve mountain conditions. Workers cut wider runs over varied terrain, distinguishing them between beginner and expert. Companies not only replaced tow ropes with chair lifts, but also invested in more lifts for new runs. Arapahoe Basin ski area opened in 1946 with primitive facilities. An old military truck hauled skiers halfway up the mountain to a rope tow. By 1948, two chair lifts had been installed. The nation's first double chair lift was installed at Berthoud Pass ski area in 1947 with funding from the Arlberg Club. In 1950, a new tow gave Winter Park the ability to handle more skiers than any other ski area in Colorado. In the 1950s, the largest companies began grooming slopes with corduroy to eliminate icy areas. These and other improvements made the sport enjoyable and accessible to more people, who then skied throughout the corridor in increasing numbers. During the decade following the war, visits to ski areas in Colorado increased by 428 percent.⁶¹⁰

The sport blossomed in the corridor from the mid-1950s through the 1970s. As skiing became an attractive source of profit, investors expanded existing areas, built complex new resorts, and aggressively promoted them out of state. The industry began to move away from challenging, nature-based recreation toward a casual, commercialized culture. *Après ski* culture and its images of glamour, celebrity mystique, and European sophistication developed as an important part of the emerging resort atmosphere, where skiing was promoted as a scene and not merely a sport. Towns near ski areas catered to the *après ski* demand by establishing restaurants, bars, and cafes, and skiing began shaping the mountain economy more than any other form of recreation. Whereas around seven areas existed during the 1930s, more than thirty were scattered

⁶⁰⁹ Hauk, Paul. *A-Basin Ski Area Chronology*. Glenwood Springs, CO: U.S. Forest Service, White River National Forest, 1979(a), 1; Coleman 2004:92, 9; Philpott 2002:265.

⁶¹⁰ Crampon, L.J. and Ronald D. Lemon. *Skiing in the Southern Rocky Mountain Area*. Boulder, CO: U of Colorado, Bureau of Business Research, circa 1957, 32; Philpott 2002: 266.

throughout the state by 1966. Some of the largest and oldest areas included Loveland, opened in 1936, Vail in 1962, Meadow Mountain near Vail in 1966, Keystone in 1970, Copper Mountain in 1972, and Beaver Creek in 1980.⁶¹¹

Loveland Ski Area

After opening in 1936, Loveland became one of the most sophisticated areas with several tow ropes and a warming hut. The area remained small until Tenth Mountain veteran Peter Seibert organized a group of stockholders to buy the establishment in 1955. Seibert acted as general manager and instituted improvements that kept the area on the forefront of the industry. In 1955, before moving on to pioneer skiing at Vail two years later, Seibert contracted with Heron Engineering for Loveland's first two chairlifts. In the late 1950s and early 1960s, Heron Engineering added chairlifts No. 3 and No. 4 over the future site of Eisenhower Tunnel, started in 1968, expanding available terrain. Loveland replaced chairlift No.2 with a Yan triple during the late 1980s and No.3 with a Poma quad in 1990 to accommodate more users. The Valley Lodge was constructed in 1989 and expanded in 1995.⁶¹²

Vail Ski Area

Experienced skiers Earl Eaton and Peter Seibert met during the early 1950s while working at Aspen ski area, and shared a vision of establishing their own resort. During warm weather, they perused Colorado, New Mexico, and Wyoming for potential ski areas and had luck in the central mountains. Eaton prospected for uranium, in heavy demand at the time, during the summer months and worked at ski areas in winter. He discovered what became Vail's Back Bowls in 1954 while prospecting. He contacted Seibert and together they explored the terrain around Vail Valley. In 1957, they secured investors and purchased Hanson Ranch at the base of Vail Mountain for a destination resort. The investors formalized the project under the Vail Corporation, negotiating with the Forest Service to build ski runs on public land and beginning work in 1961. Among the investors was Denver oilman George Caulkins, Jr., who recruited other investors from Texas and the Midwest including a roster of well-known corporations such as Murchison, Sears Roebuck, Quaker Oats, Schlitz, Federated Stores and Upjohn Company. Vail developers had an ongoing conflict with rivals who had targeted Breckenridge as a site for a new resort, with Vail Corporation filing a formal protest over their competitors' permit application to the Forest Service (Breckenridge prevailed and opened in 1961). Vail, among the largest destination resorts in the Rocky Mountains at the time, opened ahead of schedule in December of 1962. The resort targeted elite skiers and their families with two lodges, four restaurants, a filling station, four-person Bell gondola, two double chairlifts, larger Poma lift, ski school, runs on the front side, and the Back Bowls. Yet from the beginning, the resort was conceived as a year-round playground offering far more than just a place to ski. The resort included multiple hotels, shops, private homes, a nine-hole golf course, and facilities for trout fishing. Importantly, the success of the resort hinged on the selection of U.S. 6 as the route for I-70 through the mountains, which ultimately occurred in 1960. In 1966, the town of Vail was incorporated.⁶¹³

The Vail Corporation created controversy in 1968 when it proposed significant modifications and additions to its system of runs. In particular, ski area planners intended to

⁶¹¹ Mather, Sandra F. and Summit Historical Society. *Images of America: Summit County*. Charleston, SC: Arcadia Publishing, 2008, 125; Coleman 2004: 118, 124-126; Fay 2000: 89; Philpott 2002: 294-6.

⁶¹² Colorado Ski History website.

⁶¹³ Fay 2000: 90, 95; Philpott 2002: 299-315.

bulldoze the terrain, but the Forest Service determined that the heavy equipment would promote excessive erosion. After careful studies and negotiations, the two parties agreed to selective bulldozing, immediate revegetation, and subsequent monitoring until the disturbed ground stabilized. When the management practice proved to be effective, Vail, and later Keystone and Copper Mountain, adopted it for development. Vail ski area was enormously successful and, with Meadow Mountain, grew large enough to support the town of Vail year-round.⁶¹⁴

Keystone Ski Area

Max Dercum, a snow scientist, moved to Colorado with wife Edna during the late 1930s. In 1941 they purchased the Black Ranch adjacent to the idle Keystone sawmill on the Snake River in Summit County, because of its proximity to heavy snowfall. Within a short time, the Dercums renamed their property Ski Tip Ranch and opened it to local and vacationing skiers. No formal ski area existed, but users explored nearby slopes and logging roads. Shortly after, Arapaho Basin ski area opened in 1946, Max became a director and learned the basics of ski planning. With this knowledge, he determined that Keystone Mountain, rising south of Ski Tip Ranch, was ideal for a resort and began promoting the idea. He interested investors and local land owners who formed Ski Valley USA, Incorporated, in 1965, negotiating with the Forest Service for a special use permit. The Forest Service approved the area plan in 1967, but lack of funding delayed progress until 1969. At that time, William Bergman and Dercum reorganized the venture as Keystone International, obtained capital from Ralston Purina, and completed several lodges and four chairlifts on Keystone Mountain. The ski area opened in November 1970.

Keystone International established precedent in environmental planning when designing and building the runs and lift system. While the area was in a formative stage, Summit County enacted a series of environmental protection and compliance laws with strict rules on ski area development. Area design, planning process, and construction were carefully monitored, with finished terrain and contours left as natural as possible. After the first season, it became apparent that modifications were necessary for skier safety. The company used the opportunity to add two more lifts and snowmaking equipment in 1972. In later years, the company installed several more lifts and opened the Outback south of Keystone Mountain.⁶¹⁵

Copper Mountain Ski Area

During the early 1950s, the Forest Service surveyed Ten Mile Canyon for suitable ski area sites. In a 1954 statement, the agency recommended Copper Mountain because the landform possessed a variety of terrain, natural ski runs, and a valley floor for base facilities. Developers became interested in the site during the late 1960s when Denver was awarded an opportunity to host the 1976 winter Olympics. Investors pushed special use permit negotiations during 1969, began construction the next year, and opened the ski area in 1971. The resort had potential for worldwide fame when the Olympic committee chose it as a backup for the 1976 games, but Colorado voters rejected the proposal to host the Olympics in a referendum. Copper Mountain was a complete resort with five lifts serving a series of runs and a three-story lodge on the mountain's northeast face. A 34,000 square-foot facility with lodges, restaurants, hotels, and condominiums was built at the base of the mountain, adjacent to the abandoned logging and

⁶¹⁴ Hauk, Paul. *Vail Ski Area Chronology*. Glenwood Springs, CO: U.S. Forest Service, White River National Forest, 1979(e), 1-10.

⁶¹⁵ Hauk, Paul. *Keystone Ski Area Chronology*. Glenwood Springs, CO: U.S. Forest Service, White River National Forest, 1979(b), 1-11; Hauk 1979(a):6-7.

railroad hamlet of Wheeler. In terrain and design, Copper Mountain remains largely unchanged, although accommodations and parking areas have been added over the years.⁶¹⁶

Beaver Creek Ski Area

The Forest Service first examined Beaver Creek as a possible resort location in 1956. The land drew little interest until 1970, when Vail Associates surveyed it, drew plans for a state-of-the-art resort, and secured a commitment to host the 1976 Olympic Alpine and cross-country ski events. Vail purchased private land for base facilities and began the permit process with the Forest Service, but stalled when Coloradans rejected the Olympics. After reassessing the ski area's viability, Vail moved forward but had difficulty securing the Forest Service required permit. Land use concerns and sensitive environmental conditions drew widespread scrutiny and delayed the project for years. After prolonged negotiations, the Forest Service finally granted the permit in 1976, allowing Vail to begin work the next year. Beaver Creek Resort finally opened in 1980 after a rigorous process that Forest Service district ranger and author Paul Hauk referred to as "one of the most intensely analyzed ski area proposals in the United States."⁶¹⁷

HISTORY OF SCENIC TOURISM AND RESORTS

Early Scenic Tourism and Recreation, 1860 to 1877

Scenic tourism in the corridor grew out of a broader nineteenth century leisure movement initially transplanted to the eastern United States from Europe. Victorian vacations were the exclusive purview of the affluent, centering around uplifting natural scenery, curative mineral springs, and a busy calendar of social events where hierarchies in social status could be displayed and affirmed. In England, the wealthy went to Bath for "the season," entertained with social visits, concerts, receptions, lectures, and balls. In the eastern United States, resorts such as Saratoga Springs and Carlsbad Springs offered similar social rituals and diversions. By the 1870s, new hot springs resorts in the West beckoned.⁶¹⁸

William Byers, editor of the *Rocky Mountain News*, saw the economic potential in Colorado tourism shortly after Euro-American settlement. Byers tirelessly promoted Colorado as a tourist destination, and during the 1860s, served as a tour guide for noted eastern travel writer Bayard Taylor, newspaperman Samuel Bowles, and landscape painter Albert Bierstadt, hoping to impress these influential tastemakers. He succeeded as Taylor published *Colorado: A Summer Trip* in 1867, Bowles published *The Switzerland of America: A Summer Vacation in the Parks and Mountains of Colorado* in 1869, and Bierstadt created many celebrated paintings including his masterpiece, "Storm in the Rocky Mountains" (1886). More than just a tourism promoter, Byers had a vested interest as he was also a spa developer, establishing the Hot Sulphur Springs Resort in Grand County.⁶¹⁹

Resorts and inns catering to tourists began appearing in the I-70 corridor in the 1860s, although vacationers were dependent on travel by coach, wagon, or horseback on a rudimentary road network. Clear Creek County was the initial principal destination for resort tourists, arriving in 1866 on the tail end of the gold rush. Idaho hot springs, discovered in 1859 by prospector

⁶¹⁶ Hauk, Paul. *Copper Mountain Ski Area Chronology*. Glenwood Springs, CO: U.S. Forest Service, White River National Forest, 1979(d), 1-9.

⁶¹⁷ Hauk, Paul. *Beaver Creek Ski Area Chronology*. Glenwood Springs, CO: U.S. Forest Service, White River National Forest, 1979(c), 1-10.

⁶¹⁸ Lvfgren, Orvar. *On Holiday: A History of Vacationing*. Ewing, N.J.: University of California Press, 1999, 112-113; Abbot 2000: 223.

⁶¹⁹ Philpott 2002: 26

George Jackson, was the basis for the first resort, however primitive (see Illustration A 7.1). The springs first attracted curiosity rather than development because local miners were more interested in gold than curative bathing. Cornish miner James Jack and son thought the springs indicated hardrock gold and sank an 18' shaft nearby, but abandoned the project when the shaft disintegrated and filled with hot water. Dr. E.E. Cummings envisioned other possibilities for the springs, acquiring ownership of all six in 1863 and constructing a small bathhouse. As simple as the facility was, it allowed miners to bathe in warm water, an activity otherwise difficult given the primitive living conditions of the time. Between 1866 and 1871, Harrison Montague purchased the springs and had the water analyzed. According to results, the water had antacid and laxative qualities, and bathing could alleviate rheumatism, skin ailments, and other issues. Although tourists were few, Montague built the Ocean Bath House, the first destination resort in the region. The resort featured a 4' deep, 24'x40' swimming pool, baths for men and women, hot and cold showers, and a small hotel. Shortly after, the Mammoth Bath Company built another facility with a larger pool and accommodations.⁶²⁰

As the 1870s progressed, tourists discovered other towns in Clear Creek valley where entrepreneurs ran quality hotels. Although hostlers gladly received tourists, they initially appointed their establishments for the comfort of mining investors interested in the valley's booming industry. The tourists also found mining as intriguing as the natural beauty for which the valley was known. The Beebee House hotel in Idaho Springs (razed in 1907) boasted 100 rooms and a dining room that could accommodate 125 people. The Teller house in Central City was built in the 1870s by Henry M. Teller, president of the Colorado Central Railroad. The Barton House in Georgetown was the most luxurious, with men's and women's parlors, a billiard room, dining room, bathroom with hot and cold running water, and toilets for ladies, though it was destroyed in a fire in 1871.⁶²¹ Built in the early 1860s, the Peck House in Empire is one of the oldest extant hotels in the corridor. The Pecks enlarged the hotel several times, and by 1880, it included a billiard room, bar, poker room, parlor, library, and numerous guest rooms.⁶²²

Local entrepreneurs noticed that several mountain basins were popular day excursion destinations among tourists. Chicago Lakes above Idaho Springs and Green Lake southwest of Georgetown were the most heavily trafficked, and several individuals concluded that they were good sites for remote resorts. The largest was built at Green Lake in 1871, and initially the only means of access was by foot or horseback. The following year, the proprietor completed a wagon road that brought guests who expected comfortable accommodations and entertainment in addition to a wilderness experience. To meet their needs, the owner expanded the resort to include the main guesthouse, bathhouse, picnic grounds, and a dock on the lake for punts.⁶²³

Railroads and Resorts, 1878 to 1914

Railroads changed tourism in the I-70 corridor. Previously, stages and omnibuses were the only means of transportation, but the long trip over rough roads discouraged travelers.

⁶²⁰ Bowland, Laverne. "History of the Hot Springs Hotel." *Tailings, Tracks, & Tommyknockers: History of Clear Creek County*. Denver, CO: Specialty Publishing Company, 1986, 21; Crofutt, George A. *Crofutt's Grip-Sack Guide to Colorado: A Complete Encyclopedia of the State*. Omaha, NE: Overland Publishing Company, 1885 [reprinted by Cubar Associates, Golden, CO, 1966], 107; Frost, 1880:277, 294; Gillette 1978:5-6, 27, 34-35, 144-145, 151.

⁶²¹ Leyendecker et al. 2005: 185-187.

⁶²² Peck House. *Peck House History*. March 5, 2010, <http://www.thepeckhouse.com/history.htm>.

⁶²³ Chicago, Rock Island and Pacific Railway. *Colorado Cities and Places: Glenwood Springs, Cascade, Manitou, Green Mountain Falls, Denver, Buena Vista, Colorado Springs, Pueblo, Estes Park, Idaho Springs: Peaks, Parks, Canons, and Mountain Resorts*. Chicago, IL: National Journalist Press, 1890, 47-48; St. Louis, Kansas City and Northern Railway Company. *The Famous Rocky Mountain Resorts in Colorado and How to Reach Them (Season of 1877)*. St. Louis, MO: Levinson and Blythe, 1877; *Colorado Miner*, (6/8/71); *Colorado Miner*, (5/12/87); Leyendecker et al. 2005: 90-91.

Railroads not only delivered tourists directly to communities, but also allowed a nearly uninterrupted journey from the Midwest and East. The result was a huge increase in tourists diverse in fitness level, demography, and gender. Destination resort tourism peaked and remained high until around 1915 when World War I, decline in available accommodations, and preference for auto travel changed traveler patterns.

Completion of the Colorado Central Railroad to Georgetown in 1877 provided tourists direct access to the principal communities in Clear Creek valley, and entrepreneurs built more resorts in response. Each town saw increased patronage, although Idaho Springs and Georgetown benefitted the most because they offered the widest variety of accommodations. Tourism became so prevalent during the 1880s that the Colorado Central (CCRR) ran as many as seven trains per day from Denver. Colorado recreation historian Kenneth Helphand accurately described nineteenth-century resort hotels as “the most glorious and palatial structures in town.”⁶²⁴ Concentrated in Clear Creek drainage and at Glenwood Springs, resorts and hotels were full-service destinations where tourists vacationed in luxury against the backdrop of the Rocky Mountains. Denverites also took advantage of easy rail access for sightseeing day trips, adding to the number of visitors to the region.⁶²⁵

Idaho Springs was the first community where railroad tourists journeying from Denver could disembark. Due to improvements at the hot springs resorts, the town became known as the Saratoga of the West after Saratoga, New York. At the time, Saratoga was widely recognized for its mineral springs and luxury resorts, and a destination for vacationing elite. Although mining continued to be the community’s principal industry, tourism was lucrative and also central to the economy. Promotional brochures published by various railroads in the Midwest and East touted the town’s mild weather, infrequent snow, and proximity to the springs. In 1880 no fewer than seven hotels were operating in addition to Harrison Montague’s hot springs resort: the Beebe House, the Colorado Hotel, Hotel Stanton, New Metropolitan Hotel, American Hotel, King Hotel, and the German House.⁶²⁶

Tourism was so profitable that William P. Daniels, a regional mining investor, ventured into the resort trade, buying Idaho Hot Springs from Montague in 1890. Daniels expanded the hotel with a wing on each side, converting the original building into a lobby. An elevator lowered guests to the basement level, featuring baths and a spa with masseuses and masseurs. The original Ocean Wave and Mammoth pools had been replaced by a naturally heated cavern and massive 40’x80’ natatorium with a toboggan and elaborate trapeze. The resort complex also included a dining hall, casino, tennis court, and single-occupancy cabins along Soda Creek (see Illustration A 7.2).⁶²⁷

In Empire, the Peck family renovated the Peck House in 1888, and the new Fall River House opened as an inn. Georgetown, the last stop on the Colorado Central, lacked hot springs but instead offered scenery, culture, and remote mountain access. Tourists heavily patronized Green Lake resort, providing enough business to support a number of well-appointed accommodations in town including the Yates, Barton, and American houses and Star and Centennial hotels (see Illustration A 7.3). Louis Dupuy’s Hôtel de Paris may have been the most luxurious. Dupuy, French miner turned hostler, brought fine European lodging and dining to

⁶²⁴ Helphand, Kenneth I. *Colorado: Visions of an American Landscape*. Niwot, CO: Roberts Rinehart Publishers, 1991, 206-207.

⁶²⁵ Frost, Aaron. "History of Clear Creek County." *History of Clear Creek and Boulder Valleys, Colorado*. Chicago, IL: O.L. Baskin & Company, 1880, 296; Gillette, Ethel Morrow. *Idaho Springs: Saratoga of the Rockies: A History of Idaho Springs, Colorado*. New York, NY: Vantage Press, 1978, 151; Leyendecker, Liston E., Bradley, Christine A., and Smith, Duane A. *The Rise of the Silver Queen: Georgetown, Colorado, 1859-1896*. Boulder, CO: University Press of Colorado, 2005, 185.

⁶²⁶ Frost, 1880:294; Gillette 1978:44, 55, 143-144, 151.

⁶²⁷ Bowland 2004:21; Gillette 1978:158-159.

Georgetown, but not for all comers. Reclusive and cantankerous, Dupuy developed a reputation for refusing service to difficult, demanding, or unappreciative guests.

Georgetown also became the starting point for an excursion known to many vacationers elsewhere in the nation and even internationally. Described in Section A 5: Railroads, Union Pacific Railroad built the Georgetown, Breckenridge & Leadville Railroad (GB&L) in 1884 as a first stage in crossing the Continental Divide. GB&L was a short-line ascending from Georgetown through Silver Plume to a dead-end railhead at Graymont. Union Pacific abandoned its plans to cross the Divide and left GB&L as a short-line, but with a route recognized as an engineering marvel in a stunning mountain setting. GB&L looped over itself on a high steel bridge before winding through a series of tight switchbacks on its ascent from Georgetown. Tourists came by the thousands to ride the Georgetown Loop, and GB&L earned as much from tourism as mining freight. Union Pacific platted Graymont in 1883 to capture tourism and freight business from Bakerville, and both communities served as trailheads for mountaineers (see Illustration A 7.4). In 1907, GB&L built the Sunrise Peak Aerial Tramway, Colorado's first gondola lift for tourists, drawing up to 500 passengers a day. It had twenty-six open cars, painted bright yellow, each holding four people.⁶²⁸

In 1906, Edward J. Wilcox completed another mountain railroad that neatly complimented GB&L's tourist service. Wilcox's Argentine Central Railroad started in Silver Plume, ascending through switchbacks up to his mining complex in the Argentine district southwest of Georgetown. Like GB&L, the Argentine Central combined tourism and mining freight, but its claim to fame was as the highest railroad in the continental United States. Until hostile ownership ruined the relationship between the two railroads in 1909, they cooperated in promotion and service to provide vacationers with a unique experience. The Argentine Central ceased running in 1918 and the GB&L discontinued regular rail service to Silver Plume in 1920, discouraging railroad-related tourism. The tramway was subsequently abandoned.

Frisco was the principal tourist destination in Summit County because of its picturesque location as gateway to rugged Ten Mile Canyon. The town began in 1879 as a commercial center for a local mining boom, remaining small and primitive until 1882, when the Denver South Park & Pacific Railroad and Denver & Rio Grande Railroad completed lines. Although Frisco was only a minor stop between Denver and Leadville, tourists discovered the hamlet during the mid-1880s. But their numbers remained small because Frisco was a mining and logging community lacking well-appointed hotels, restaurants, or excursions. The Leyner House and Frisco Hotel initially provided accommodations for mining investors, but when tourists began showing interest, the owners improved their buildings with new rooms, bedding, and décor. The hotels fell into disrepair after the Silver Crash of 1893. John and Jane Thomas purchased the Leyner in the late 1890s after the economy recovered and tourists returned, renaming it the Thomas Hotel. Shortly after, C.O. Linquist bought the Frisco while Con Ecklund opened the Southern Hotel, although competition from resort towns elsewhere in Colorado diverted patronage. Tourism declined around 1910 as result, with only the Southern surviving the decade.⁶²⁹

Although Glenwood Springs became the premier resort destination in Garfield County, three developers filed a plat for the Siloam Springs Sanitation and Town Company in early 1884. Their proposed townsite and resort were on both sides of the Colorado River in Glenwood Canyon, east of Glenwood Springs. By the mid-1880s, the operators completed a hotel, hot springs bathhouse, and hospital. The small resort thrived at first when the Denver & Rio Grande Railroad pushed its Glenwood Springs line from Minturn to Glenwood Springs in 1887. When

⁶²⁸ Fay 2003:130; Colorado Ski History website, <http://coloradoskihistory.org/lost/sunrisetram.html>, accessed 2/7/2012.

⁶²⁹ Gilliland 1984:15, 24, 26, 35.

the Silver Crash ruined Colorado's economy, the tourist trade was unable to support all the resorts in the area. Siloam Springs could not compete against nationally-known Glenwood Springs and closed. The resort buildings were sold or became part of the Bair Ranch.⁶³⁰

As a result of declining rail service to the mountains and shifting recreational tastes, resort tourism declined during World War I and never again achieved the same success. However, as automobiles became available, they enabled a new type of sightseeing in the same tradition: scenic motoring.

Automobiles and Scenic Tourism, 1915 to 1962

The late 1910s and 1920s were a time of transition for tourism in the I-70 corridor. During these decades, tourists increasingly vacationed in automobiles instead of by rail. Initially, vehicles were status symbols because their high purchase cost limited them to the wealthy. But as prices fell during the 1910s, a greater number of people were able to purchase autos for commuting and recreation. At the same time, Colorado's railroad companies facilitated the trend by incrementally reducing quality and frequency of service in the mountains. The railroads had little choice as mining declined, and with it, their revenue. From 1916 to the 1950s, Colorado lost thirty percent of its railroad service. This was the highest abandonment rate of any state, and most of it in the mountains. Closures left towns such as Georgetown, Idaho Springs, and Breckenridge inaccessible by railroad.⁶³¹

As described above in Section A 6: History of Roads, motor touring as a pastime gained enormous momentum during the 1910s and 1920s. People felt that autos provided independence and an intimate experience with the road, and drivers actively lobbied for the construction of scenic mountain roads. As was the case for skiing and outdoor recreation, affluent Denverites were influential in shaping recreation infrastructure in the corridor, and again, roads were central. In the 1910s, Denverites created the Colorado Automobile Club and Denver Motor Club and campaigned for scenic mountain roads. In 1912, the city of Denver created the Denver Mountain Park system with seventy-five miles of roadway including a skyline drive to the top of Lookout Mountain. The new park system would eventually total 13,500 acres in four counties. Motorists also traveled further into the corridor for scenic excursions, principally along U.S. 40, known at the time as the Grand Valley and Hot Springs Scenic Route.

The transition from rail to auto tourism was nearly complete by the mid-1920s. Autos were by then common among middle-class families, who drove into the mountains for sightseeing excursions. However, they did not patronize established resorts as before. Road condition was a limiting factor, so those resorts near quality roads drew auto tourists while those with poor wagon roads closed. The character of corridor towns was another limiting factor. Historically, many towns with prominent resorts originally depended on mining, such as Empire, Georgetown, Silver Plume, and Frisco. As that industry collapsed around 1920, towns lost population, fell into disrepair, and declined in services and accommodations. Auto tourists preferred accommodations that were convenient, near roads, and in well-kept towns. Further, tourists increasingly turned to new types of lodging instead of traditional Victorian hotels that seemed increasingly shabby and outdated in comparison. Most early scenic touring in the corridor was concentrated in Clear Creek County as there was no direct route further into the mountains until the Loveland Pass road was improved in 1932.

⁶³⁰ Schader, Conrad F. *Glenwood Canyon: From Origin to Interstate*. Golden, CO: Regio Alta Publications, 1996, 93-94.

⁶³¹ John F. Stover, *American Railroads*, 2nd Edition, Chicago: University of Chicago Press, 1977: 219-222.

Auto camping became extremely popular in the 1920s with national estimates of 10 to 20 million participants in the mid-1920s. In 1922, Colorado had 247 auto camps, with approximately 643,000 people using them in the state in 1923. Public and private campgrounds catering to motorists were common during this decade (see Outdoor Recreation below). By the late 1920s, accommodations for sightseeing motorists became more sophisticated, primarily cabin camps and motor courts. These businesses provided basic facilities such as simple cabins and cottages, sometimes with rudimentary furnishings, sparing tourists from carrying and constantly setting up tents and other gear. Many camps also had shared toilets, showers, and community kitchens. The impact of such lodgings was clear: by 1929 tent sales regressed to 1916 levels and camping returned to its original wilderness focus. By the 1930s, motels with improved conveniences, such as private bathrooms and onsite cafes, became common.⁶³²

Idaho Springs was the only corridor town whose tourist business survived the transition from rail to automobiles relatively intact. Even then, tourism was minor compared to previous patronage. The Rocky Mountain Motors Company acquired a ninety-nine year lease on the Idaho Springs Hot Springs Hotel and spa around the turn of the century, investing \$300,000 into remodeling facilities to increase occupancy. Patronage declined anyway, and the company sub-leased to the Idaho Springs Sanatorium Company in 1911. Business was slow but steady over the next several decades. In 1928, the N.C. Merrill family took over the property through their Surety Investment Company, which ran fine hotels in other cities. The family operated the enterprise on a limited scale into World War II.⁶³³

The major postwar expansion of highways and peace time affluence led to the rise of mass tourism after World War II. Increasing numbers of vacationers came to the corridor, drawn by the same majestic vistas that first attracted early tourists nearly a century before. In 1946, visitors to Colorado spent more than \$200 million, sixty-five percent more than in 1941, a postwar increase well above the national average.⁶³⁴ By 1948, eighty-two percent of vacationers coming to Colorado traveled by car, reaching eighty-nine percent by 1956.⁶³⁵ Many ventured into the mountains via highways U.S. 6 and 40, fostering growth of related roadside services such as filling stations, restaurants and cafes, and auto-friendly lodging such as auto camps, motor courts, and motels. By the 1950s, large motels began dominating, commanding forty percent of business along major highways.⁶³⁶

Designed specifically for traveler convenience, motels were small compounds with a garden, door-side parking, and often swimming pools surrounded by blocks of identical or symmetrically opposed rooms. Each room offered beds, a closet, bathroom, and reliable heat. An office was at the entrance, and utility rooms and vending machines strategically located amid the rooms. Motels grew in clusters along principal arteries into the towns, near other automobile-related services including filling stations, garages, and restaurants.

Although most tourists traveled by automobile during this period, railroads also attempted to capitalize on the postwar tourism boom. Denver & Rio Grande Western launched See-Liner trains running from Denver to Grand Junction in 1949. The trains were timed for optimal daylight viewing of Rocky Mountain scenery, featuring special observation cars termed Vista Domes.⁶³⁷

⁶³² Belasco, Warren J. *Americans on the Road: From Autocamp to Motel, 1910-1945*. Cambridge, MA: MIT Press, 1979, 41, 71, 74, 131, 141, 166; Abbot 2000: 240.

⁶³³ Gillette 1978:59, 160-161.

⁶³⁴ Colorado State Advertising and Publicity Committee (APC). *Making the World Colorado Conscious: General Report, 1941-1946*. Denver, CO: APC, 1947.

⁶³⁵ Crampon, L.J. *The Tourist and Colorado*. Boulder: U of Colorado, Bureau of Business Research, 1956, 32-33.

⁶³⁶ Belasco 1979: 170.

⁶³⁷ Philpott 2002: 125-6.

Beyond the grandeur of the Rocky Mountain scenery and outdoor activities (discussed below), mountain town history and culture provided another enticement for tourists. Described as heritage tourism in leisure scholarship, marketing of the historic and mythic past was largely driven by the postwar national fascination with the old west. Dude ranches, originally catering to wealthy hunters in the nineteenth century, also saw a revival by providing visitors an opportunity to experience the mystique of the old west firsthand.⁶³⁸

Tourists on road trip vacations often included sightseeing stops at old mines and ghost towns in their itineraries. Clear Creek drainage, one of Colorado's important mining centers until 1920, was primed for heritage tourism. In the 1940s, James Grafton Rogers (first President of Colorado Mountain Club, law school dean, and Assistant Secretary of State under Hoover) moved to Georgetown and became mayor. Fascinated with mining and railroad history, Rogers made restoration of Georgetown's Victorian heritage a priority when he became President of the Colorado Historical Society. In the 1950s, Rogers collaborated with Stanley Wallbank, who owned old claims around the defunct Georgetown Loop, in the area's preservation. Benjamin Draper was Director of the Colorado Resources Development Council and President of Georgetown Enterprises, Inc., an organization created in the 1940s to revive Georgetown's quaint Victorian downtown with the goal of attracting tourism. Under Draper's leadership the organization purchased and restored numerous commercial buildings along Alpine Street, converting them to restaurants, gift shops, and souvenir shops catering to campers, anglers, hikers, skiers, and visiting motorists. Guidebooks, such as those by Muriel Sibell Wolle (*Stampede to Timberline*, *The Bonanza Trail*, and others), popularized mining ruins and ghost towns in the 1940s and 1950s. Restored attractions in historic mining towns like Central City, Idaho Springs, Black Hawk, and Georgetown benefited from this trend. Eventually, the area around Georgetown and Silver Plume was designated a National Historic Landmark district in 1966, the GB&L grade partially reopened for steam trains in 1975, and the Georgetown Loop rebuilt in 1984.⁶³⁹

HISTORY OF OUTDOOR RECREATION

The theme of outdoor recreation covers activities apart from skiing and resorts that left distinct historic resources in the I-70 corridor. The principal activities included fishing, hunting, picnicking, camping, and hiking. All participants sought an outdoor experience in the natural environment, but with facilities such as picnic grounds, trails, and campsites. Coverage is broad and general because outdoor recreation is not well documented in sources for the relevant Period of Significance 1860 to 1962.

The evolution of outdoor recreation was influenced by two main factors: cultural ideas about nature-based leisure, and access to natural areas shaped by changes in transportation. During the mid-nineteenth century, these factors reinforced each other to produce a romantic new American identity based on the frontier and landscapes of the West. Becoming increasingly concerned with the effects of urbanization, writers such as Henry David Thoreau, Ralph Waldo Emerson, and John Muir advocated a return to nature as a healing spiritual antidote. As railroads opened up the West to travelers, images of spectacular wilderness provided the basis for a new chapter in the national myth, drawing America's attention away from scars left by the Civil War. Renewal and hope was to be found in the country's natural heritage.⁶⁴⁰

⁶³⁸ Rothman 1998: 23.

⁶³⁹ Philpott 2002: 153, 157-8.

⁶⁴⁰ Rothman 1998: 41; Jensen, Clayne and Steven Guthrie. *Outdoor Recreation in America, 6th Edition*. Champaign, IL: Human Kinetics, 2006; Cindy S. Aron. *Working at Play: A History of Vacations in the United States*. New York, NY: Oxford University Press, 2001, 157.

In addition to established urban recreation patterns emphasizing cultural refinement and intellectual edification, a new tradition of leisure in nature developed among the upper and mercantile classes in the East, as stage coach lines and railroads provided access to areas such as the Adirondack and White mountains. Such recreation activities were a blend of physical outdoor pursuits such as fishing, hiking, and boating, enjoyment of scenery, social rituals, and relaxation in hot springs. By 1875, more than 200 hotels existed in the Adirondacks. Some had hundreds of rooms and were known as the Adirondack Great Camps. By the 1870s, the growing middle classes also began discovering outdoor vacations. Their excursions were considerably less luxurious and far simpler than the costly Adirondack Great Camps, generally involving cumbersome tents, stationary campsites, and simple activities with family.⁶⁴¹

The early experiments with outdoor vacations emerged in tandem with a growing national interest in nature-appreciation and outdoor recreation. A movement by the 1880s, outdoor recreation embraced the uplifting, wholesome characterization of Emerson, Thoreau, Muir and others, as well as a perception that American landscapes should be a source a national pride. The movement produced a number of groups and clubs that organized outings and began creating facilities in support. The Appalachian Mountain Club was formed in 1876 and began building trails and huts in New Hampshire. The Sierra Club was founded in 1892 in California, offering outings and camping trips. Other early groups included the American Alpine Club (1902), National Audubon Society (1905), and the American Boy Scouts and Campfire Girls (1910).⁶⁴²

From the 1860s through 1910s, the outdoor movement manifested in the I-70 corridor as several broad patterns. Elite families from Denver and the East began vacationing in resorts, where they enjoyed leisure, picnicking, fishing, riding, and limited hiking. Adventurous families camped with assistance of packing outfits, while men came without family to trophy hunt, fish, and even mountaineer on professionally guided trips.

In addition to elite travelers coming from outside the area to vacation, local corridor residents also enjoyed outdoor recreation from the time of settlement. Whereas urban intellectual activities such as social events, the arts, lectures, and performances were the dominant recreation of the era, corridor communities had difficulty fully participating. Isolation and slow communications limited contact with greater urban centers, and most communities lacked the necessary critical mass of people and cultural sophistication. Georgetown was an exception, largely because it was a wealthy cultural center. Corridor residents opted for outdoor diversions instead, primarily out of general interest and as a premise for social events. Their activities were similar to those enjoyed by the elite, but without the professional support of guides and outfits. Accustomed to a rugged lifestyle in the mountains, corridor residents were more willing to undertake strenuous activities including long hikes, primitive camping, and remote hunting.

Railroads were instrumental in opening the corridor to mass tourism. Completion of lines up Clear Creek in 1877, the Blue River valley in 1882, and the Eagle and Colorado river valley in 1886 made these areas accessible to those eager to see the region. Further, railroad companies both in Colorado and the east acknowledged potential profit in the mass movement of tourists, and began promoting the outdoors to increase business. An 1890 tourist brochure published by Chicago, Rock Island & Pacific Railway encouraged:

⁶⁴¹ P.G. Terrie. *Contested Terrain: A New History of Nature and People in the Adirondacks*. Syracuse, NY: The Adirondack Museum/Syracuse University Press, 1997; Aron 2001: 160-4.

⁶⁴² Jensen and Guthrie 2006: 26.

Once a year, at least, men and women of every class and condition are forcibly reminded that the monotony of daily toil or the merciless exactions of fashionable and social life must be interrupted by a season of welcome rest, including a hygienic change of diet, water, soil and climate, under favoring circumstances and amid congenial surroundings, before the health and capacity for enjoyment are irretrievably wrecked.⁶⁴³

The Denver & Rio Grande, Colorado Central, and Denver, South Park & Pacific, built primarily for mining, all promoted Colorado as a tourist destination. Vacationers came by rail from the Midwest and East to enjoy the Rocky Mountains, highlighting the corridor as an outdoor recreation destination.

The nationwide adoption of automobiles during the 1910s and 1920s revolutionized outdoor recreation. As roads improved and disposable income rose, a larger segment of the population began vacationing. In parallel, autos provided greater mobility and autonomy than railroads, encouraging tourists to camp, hike, and hunt in smaller groups, and in remote areas. Outdoor recreation destinations were thus often primitive although auto-accessible. Construction of facilities such as picnic and campgrounds in National Forests contributed to the trend, and for those tourists unwilling to rough it, entrepreneurs in principal towns constructed auto courts and urban campgrounds with cabins, tents, and bathrooms. In addition, the Term Permit Act of 1915 made it possible for private interests to lease land in National Forests for the purpose of creating recreational facilities including lodges, cabins, summer homes, and camps. As a result, visitors to National Forests increased from 1 to 5 million between 1910 and 1920, the *New York Times* estimating in 1922 that of the 10.8 million cars in the United States, nearly half were used for camping.⁶⁴⁴

The Great Depression was another important period for outdoor recreation. The poor economic climate and limitations in personal income encouraged people to enjoy affordable outdoor leisure. Hotel occupancy declined, but auto camping remained popular. Camping, picnicking, and hiking were inexpensive compared to resorts and many urban activities. Hunting and fishing were a means of supplementing food, as well. At the same time, federal and state agencies provided tourists with new facilities. Road and trail building, and creating recreational facilities were perceived as a way to stimulate the economy through New Deal programs. For example, WPA eventually spent over \$100 million in Colorado, becoming the largest single employer in Colorado in 1936 with over 43,000 workers. By 1942, WPA had undertaken more than 5,000 projects in the state, including construction of 124 recreation buildings.⁶⁴⁵ The WPA, PWA, CCC, and National Youth Administration built camp and picnic grounds near most corridor communities. As historian Ethel Morrow Gillette noted regarding Idaho Springs, CCC camps were scattered throughout Clear Creek County. The camps typically consisted of small parking areas, running water, picnic tables, bathrooms, and shelters, usually well built with local materials. The facilities and their popularity with the public became a lasting foundation for recreational patterns that persist today.⁶⁴⁶

Finally, the postwar tourism boom brought unprecedented numbers of visitors to the corridor. In response to increased tourism and recreational use of natural areas, the National Park

⁶⁴³ Chicago, Rock Island and Pacific Railway, 1890: 3.

⁶⁴⁴ Draper, Ben. *History of the Mountain Parks*. Denver, CO: Federal Civil Works Administration, 1934, 20; Wyckoff, William. *Creating Colorado: the Making of a Western American Landscape, 1860-1940*. New Haven, CT: Yale University Press, 1999, 97; Abbot 2000: 239. Jensen and Guthrie 2006: 28; Wolf, Tom. *Arthur Carhart: Wilderness Prophet*. Boulder, CO: University Press of Colorado, 2008, 101; Belasco 1979: 72-6.

⁶⁴⁵ Abbot 2000: 289,291.

⁶⁴⁶ Brockman, Christian Frank and Lawrence C. Merriam. *Recreational Use of Wild Lands*. New York, NY: McGraw Hill, 1979, 73; Gillette 1978: 137.

Service, U.S. Forest Service, and Colorado Department of Game and Fish made important investments in facilities and infrastructure. In addition, tourism promoters across the state became more organized and coordinated. In 1951, Governor Thornton convened a Travel and Hospitality Conference in Denver, with over 600 participants including the state Hotel Association, the Dude and Guest Ranch Association, and Rocky Mountain AAA, outdoor sports clubs, local chambers of commerce, representatives of the U.S. Forest Service, National Park Service, state Highway Department, and Colorado Department of Game and Fish. The convention became an annual event where tourism boosters developed themes and strategies and the State Advertising and Publicity Committee would coordinate marketing efforts.⁶⁴⁷ Tourism and outdoor recreation were at last widely seen as an important sector of the state's economy. Lobbying around the extension of I-70 into the high country became a key rallying point for tourism boosters in the 1950s, as they saw this artery as being vital to the long term health and growth of the industry.

Fishing and Hatcheries

Fishing was, and still is, favored recreation among both tourists and residents. They fished for sport, camaraderie, household consumption, and income through sales. It seemed like mountain streams and lakes offered enough fish for all in Colorado's early years, but the growth of tourism and demands of the permanent population threatened the waterways with over-fishing. Colorado struggled to maintain fish stocks throughout the nineteenth century and into the twentieth. The territorial and later state government followed two approaches to prevent the collapse of fish populations and the riparian habitat.

Regulation was the first method. Pike's Peak gold rushers caught so many fish for food in 1860 that the Territorial Assembly passed a law the next year banning nets, baskets, and traps. Colorado appointed the first Fish Commissioner in 1877 to control fishing and the fish population as best he and small staff could. When it became apparent that this was insufficient, the state established the Fish and Game Department, forcing anglers to limit catches to twenty pounds per day beginning in 1898 and to obtain licenses by 1909.⁶⁴⁸

Restocking waterways was the state government's other approach in avoiding over-fishing. Private entities began restocking some Front Range lakes with bass and trout during the late 1870s. One of these was the Green Lakes resort above Georgetown, which built its own hatchery in 1876. The facility included two fish reservoirs on the lakeshore and a 25'x60' fish-house with 15,000 trout and 35,000 California salmon, and 200,000 hatchlings. The Fish Commissioner continued the state restock policy, opening a fish hatchery north of Denver in 1881. During the next two decades, the Fish and Game Department established eight satellite hatcheries in the principal mountain drainages, while private interests ran others. The hatcheries were important to the mountain economy because they provided the fish that drew tourists.⁶⁴⁹

A strong interest in fishing among local and out-of-state vacationers stimulated a small hatchery boom around the turn of the century. At the same time, private fishing camps became popular recreation destinations, and corridor communities organized fishing clubs. Women began participating. Through their hatchery, the Green Lakes resort owners were among the earliest in the corridor to reach out to anglers. But by the 1890s, activists in other communities

⁶⁴⁷ Philpott 2002: 127-8.

⁶⁴⁸ Carrington, Raye. *Pearl Lakes Trout Club, Inc.: A History*. Austin, TX: Self-published, 1990, 21; Colorado Midland Railway. *Hunting Fishing, Camping in the Colorado Rockies*. Denver, CO: Smith-Brooks Press [circa 1908], 23, 25; Page, Charles A. *Rocky Mountain Fish Tails*. Gunnison, CO: Page Books, 1975, 89-91.

⁶⁴⁹ *Colorado Miner* (1/1876): 3; *Colorado Miner* (7/1876): 3.

made the connection between fishing and tourism and promoted opportunities in their areas. Eagle County interests published a booklet in 1899 claiming that: “every stream in the county is full of fish. . . [and] the lakes of the county are. . . great summer resorts for camping parties, who spend several weeks or months on their cool banks.”⁶⁵⁰ An early-twentieth-century booklet suggested that the streams and rivers near Avon were unsurpassed and that Lake Creek in Edwards was famous for its large catches.⁶⁵¹

Although many people fished during day outings, some combined the activity with camping. A segment of the overall outdoor movement, anglers, and primarily men, established fishing camps in undeveloped areas near lakes and large streams as early as the 1880s. The camps were typical of those dating to the nineteenth and early twentieth centuries with wall tents, large fire hearths, and benches or logs for seating and food preparation. As the sport increased in popularity and appealed to a broader demography, anglers increasingly built cabins for comfort.

Fishing continued to be among the most popular forms of recreation through the twentieth century. Agencies made investments to support fishing during the 1930s and after World War II. By 1938, the CCC had stocked Colorado streams and lakes with over 2 million fish.⁶⁵² The United States Forest Service, Colorado Department of Game and Fish, and United States Fish and Wildlife Service were all involved in efforts to create more public places for fishing and improve fish stocks after the war. The agencies dredged rivers and streams to create fishing holes, built artificial lakes, and graded roads to make areas more accessible. Hatcheries were created in Leadville and Rifle in response to angler demand. Much of this work was part of Operation Outdoors, a five-year effort launched in 1957 to build new facilities on Forest Service lands. Fishing and related tourist-spending supported local economies, recreational facilities such as campgrounds, and related businesses, including those selling fishing licenses, bait, equipment, and guided excursions.⁶⁵³

Hunting

Hunting has been an important activity in the I-70 corridor for the duration of human occupation. Before removal from the mountains during the 1860s and 1870s, Native Americans relied on game for subsistence, sustainably hunting in valleys on a seasonal basis. Miners and prospectors, the earliest Euro-Americans in number in the corridor, continued the practice, supplementing diets of preserved foods rich in carbohydrates but low in protein. Because the early Euro-Americans were interested primarily in gold and silver, they shot only what they needed, preferring large animals such as deer and elk. Impact on game populations and distribution was minimal until a gold rush drew thousands of individuals into Clear Creek drainage during the early 1860s, and the Blue River valley around 1880. Widespread hunting, timber cutting, claim development, and general activity and noise drove game deeper into the surrounding mountains. Miners no longer had immediate access to game, and at this juncture, they either purchased meat from local butchers or merchants, or invested time in hunting forays. Their trips were between one and several days, during which time they established base camps. Accommodations were little more than a wall tent, fire ring, and game rack consisting of a pole

⁶⁵⁰ McCabe, William. *The Empire of the Eagle: A Descriptive History of a Great County*. Red Cliff, CO: Red Cliff Publisher, 1899, 47.

⁶⁵¹ Cocks-Clark Engraving Company. *Western Colorado, the Playground of America: Mt. of the Holy Cross and the Eagle River Valley, Eagle County*. Denver, CO: Cocks-Clark Engraving Company [circa 1910 to 1919], 13-14, 16; Grabau, Alison. *Summit Pioneers*. The Summit Foundation, 1999, 7, 87.

⁶⁵² Abbot 2000: 290.

⁶⁵³ Philpott 2002: 256-8.

lashed between trees. Hunting was primarily practical, although some individuals undoubtedly combined it with prospecting.

As game receded further into the mountains, miners found it increasingly difficult to dedicate the necessary time and resources, with an outcome of success not guaranteed. Thus, most resorted to buying their meat. This trend, multiplied by major mining booms in Clear Creek drainage, Summit County, Leadville, and Aspen during the 1880s, created an insatiable demand. Although beef was the preferred meat of the time, rush participants settled for game as a close second-best. Responding quickly to the demand, entrepreneurs organized commercial hunting parties to sell meat in volume. Because most of the game near the centers of industry was gone, they had to work deeper in the mountains, seeking environments favorable to herds of deer and elk. They moved north into Middle Park, north along the Blue River valley, and eventually west down the Eagle and Colorado river drainages. Like the miners before them, the outfits established hunting camps as bases of operation, only larger and more permanent. The typical hunting camp featured several wall tents on earthen pads, a large fire hearth, dining area, privy, and multiple racks for hanging game, all in a clearing. Professional hunting contributed heavily to near extermination of not only deer and elk in some areas, but also fowl. Recreational hunting complimented the professionals, drastically reducing select species such as bear, mountain lion, mountain sheep, and wolves. Recreational hunters, primarily elite from Denver and east, came to the corridor in increasing numbers during the 1880s and 1890s for trophies, adventure, and romance of the mythic west.

Concerned over game depletion and other natural resource abuses, the Department of the Interior began the forest reserve system in 1891, establishing the White River Timberland Reserve in 1891 (detailed in Section A 2: Timber Industry). The reserve at first protected forests in Eagle and Garfield counties, and enlarged as the White River National Forest in 1902 to include Summit County. New regulations expedited what had been a gradual shift in hunting away from business and toward recreation. In a westward progression, sport hunters replaced meat suppliers in Summit, Eagle, and Garfield counties during the 1890s. An end to wholesale herd depletion combined with responsible hunting practices allowed some game populations to recover, improving hunter experiences. Hunting parties, consisting of middle and upper-class men, increasingly came to the corridor to socialize and enjoy nature. Many stayed in remote camps attended by packing outfits, with others in hunting lodges, hotels and dude ranches catering to sport hunters.⁶⁵⁴

Dude ranching emerged in the 1880s when affluent tourists began offering cattle ranchers payment for lodging, meals, and guiding services. Eventually outfitters and guides established their own dude ranches purely as facilities to support recreational hunting, rather than as stock operations. Documented dude ranches existed in the 1890s near Evergreen, Estes Park, Grand Lake, Winter Park, and north and west of Glenwood Springs. A few almost certainly operated in the corridor during the time, combining recreation with cattle. Dude ranches enjoyed a boom in popularity during the 1920s both for hunting and other outdoor activities, with more than forty in Colorado by 1940, including St. Mary's Glacier Lodge in Idaho Springs.⁶⁵⁵

Eagle and Garfield counties became the most popular sport hunting region in the corridor during the 1890s. Local business interests heavily promoted the region to attract business, with little exaggeration. Tourism booklets published at the turn-of-the-century praised Eagle County for its hunting opportunities, recommending the town of Wolcott as a strategic center for

⁶⁵⁴ Gulliford 1983:34-36, 38; Leyendecker et al. 2005:251; McCabe 1899:46.

⁶⁵⁵ Borne, Lawrence R. *Dude Ranching: A Complete History*. Albuquerque, NM: University of New Mexico Press, 1983, 4-12, 40; Colorado Dude Ranch Association. *Colorado Dude Ranches*. Pamphlet, 1949.

expeditions. The publication specifically advertised the Wolcott Hotel for its comfortable rooms, furnished cabins, and family-style meals. This promotion drew a steady stream of hunters varying in age, skills, and game interests. Most developed favorable impressions because a quality environment supported substantial game populations, increasing chances of success. For these reasons, the western portion of the corridor has been, and still is, an important hunting destination.⁶⁵⁶

Hiking and Mountaineering

Hiking was among the earliest and most popular outdoor recreation activities in the I-70 corridor. Through its accessibility, it satisfied the desire to enjoy the landscape and experience nature intimately. Hiking was also inexpensive, required little infrastructure, and could be enjoyed individually, in groups, or with mountaineering guides. For these reasons, hiking was an activity shared by a wide demographic. In contrast, mountaineering, which involved technical climbing of mountain ranges and peaks, was a more specialized activity. Explorers, prospectors, and surveyors pioneered mountaineering in the corridor, but for practical rather than recreational purposes. Young adventurers came from outside the corridor to challenge themselves, in much the same vein as the alpine tradition that had developed in Europe. The emphasis was on bravado, on continually seeking more difficult or spectacular terrain, and on a sense that hardship was heroic.⁶⁵⁷

In the late nineteenth century, hiking was primarily an activity among resort tourists and sightseers on day trips. Because recreational trails did not yet exist, their journeys were short and tended to follow mining roads, packtrails, and natural clearings on valley and canyon floors. In Clear Creek County, business interests set precedent by grading a few recreational trails. Acknowledging that hiking was an important tourist activity, local businessmen invested capital in several routes around Georgetown to improve patron experience and increase visitation to the region. In the late 1860s, prospector Richard C. Irwin created a horse trail up Gray's Peak and began taking tourists up to the top on horseback. During the 1870s, guides and hotel operators focused on this trail, as it was one of the most popular destinations. The excursion was the last segment in a journey advertised in 1873 by the Kansas Pacific Railway. A promotional booklet recommended hiking or taking a carriage from Georgetown to the Baker Mine, overnighting at the mine boardinghouse, followed by a dawn ascent of the remaining three miles to the summit. For women and children, the publication suggested horses. The Gray's Peak journey set an example that other resort operators and tourism promoters followed elsewhere.⁶⁵⁸

Bakerville, west of Silver Plume at the juncture of Grizzly Gulch and Clear Creek, hosted a slightly different type of destination tourist. The Baker Silver Mining Company built a smelter, boardinghouse, and other buildings at the site in 1867, but the operation failed two years later. William H. Bowles conceived the vacant settlement as a base camp for mountaineers, who came not for comfort but to test themselves. In 1870, he bought the boardinghouse, converted it into an austere hotel and arranged trips to Gray's and Torrey's peaks. The hotel was one of a few that catered specifically to mountaineers.⁶⁵⁹

⁶⁵⁶ Cocks-Clark Engraving Company, 17.

⁶⁵⁷ Robertson, Jan, Jay Fell, Walt Borneman and Chris Case. *100 Years Up High: Colorado Mountains and Mountaineers*. Golden, CO: Colorado Mountain Club Press, 2011, 41-44; Lvfgren 1999: 53.

⁶⁵⁸ Robertson, Fell, Bomeman, and Case 2011: 41; Kansas Pacific Railway Company 1873: 18.

⁶⁵⁹ Ellis, Erl H. and Ellis, Carrie Scott. *The Saga of Upper Clear Creek: A Detailed History of an Old Mining Area, Its Past and Present*. Frederick, CO: Jende-Hagan Book Corporation, 1983, 209.

Hiking became a common activity around resort communities during the 1880s, and as tourism increased, so did its popularity. However, operators and promoters graded few new hiking-specific trails, basing routes on old roads and packtrails instead, and emphasizing natural attractions. Hiking as recreation increased during the 1890s, and communities specifically advertised the potential for hiking in their regions. Promoters in Eagle County invited tourists to explore the high mountain lakes, claiming that a hike to these “basins is well repaid and not difficult.”⁶⁶⁰ In Glenwood Springs, resort operators improved an old Ute Indian trail for its breathtaking views of both Glenwood Springs and the Colorado River.⁶⁶¹ Hiking as recreation changed during the 1920s due to a younger, physically active tourist demographic and their embrace of automobiles. By the end of the 1920s, Colorado’s public lands were receiving over 2 million visitors annually, most by car. Tourists traveled greater distances from resorts to notable hiking routes than before, the most popular evolving into hiking trails through repeated use, while parking areas became trailheads.

Enjoying hiking and camping together became common among mountain tourists during the 1920s. A Civil Works Administration (CWA) report noted that hikers wore distinguishing apparel of hobnail boots and khaki, enjoying long hikes over boulder-strewn hillsides and down pine-covered gulches. The Colorado Mountain Club recognized hiking as a core member activity and organized multi-day outings, mountaineering expeditions, and promotional events. Denver-based outdoor enthusiasts founded the club in 1912 to promote conservation in the central mountains, unite other outdoor-oriented people, and provide group outings.

As interest in hiking crept into popular culture, local, state, and federal agencies began building recreational trails. Denver Mountain Parks and the Forest Service graded dozens of miles of trails in the eastern portion of the corridor during the 1920s, allowing a greater number of people to experience the outdoors on a personal and direct level. As participation increased and offered tangible economic benefits to mountain communities, state and federal agencies made greater efforts to accommodate hiking, picnicking, and camping. State agencies and the Forest Service built more trails, formally designated trailheads, improved signage, and invested in planned picnic and campgrounds. Improvements in turn encouraged further recreational use, forcing agencies to revise policies toward public lands. Since the Forest Service’s inception, Gifford Pinchot was clear that the agency’s mission was management of watersheds for timber and water. But when visitors to forest lands increased five-fold during the 1920s, influential staffers like Arthur Carhart, the Forest Service’s first Recreation Engineer, advocated for recreation infrastructure as a priority. Eventually, the Forest Service changed its approach and embraced recreation, at times competing with the National Park Service for funding provided by Congress. Because tourism to national parks and forests was clearly blossoming and having a positive economic impact, many states wanted their own areas. In 1926, the Federal Recreation Act facilitated this by making public lands available for states to create their own state parks.⁶⁶²

During the 1930s, road building, trail building, and the creation of new recreation facilities was seen as a way to stimulate the economy through the New Deal programs. By 1940, there were 710 miles of trails in Arapaho National Forest and 1,050 miles of trails in White River National Forest.⁶⁶³ In the western corridor, Glenwood Springs purchased recreational land and built trails to support tourism. The town acquired Hanging Lake in Glenwood Canyon in 1924 as

⁶⁶⁰ McCabe 1899:23.

⁶⁶¹ Nelson, Jim. *Glenwood Springs: The History of a Rocky Mountain Resort*. Ouray, CO: Western Reflections Publishing, 1999, 143; Frost, 1880:285.

⁶⁶² Wolf 2008: 49; Jensen and Guthrie 2006: 29.

⁶⁶³ Draper 1934:40, 63; Wyckoff 1999:87; U.S.D.A. Forest Service. *National Forest Vacations*. Pamphlet, U.S. Government Printing Service, 1940.

a centerpiece, graded a trail from a parking area, and stocked the lake with brook trout. The CCC improved the trail in 1933 with a well-constructed route still in use today.⁶⁶⁴

After World War II, more people than ever enjoyed outdoor recreation, and many spent a day hiking while a daring few backpacked. Government agencies continued investing in outdoor recreation infrastructure through formal programs. The Recreation and Public Purposes Act of 1954 enabled state and local governments as well as nonprofit organizations to acquire certain designated federal public lands at low cost, specifically for recreational use. In 1956, the National Park Service launched Mission 66, a ten-year initiative to build and enhance its facilities. In 1957, the Forest Service launched Operation Outdoors, a five-year effort to improve its infrastructure. All of these programs led to a significant expansion of outdoor recreation, related facilities, and an understanding that activities such as hiking were a legitimate and economically important use of public lands.⁶⁶⁵

Camping

Like most outdoor activities in the I-70 corridor, camping as recreation was a product of early tourism. Although prospectors regularly camped, they did so for practical reasons. People from outside the corridor began camping for recreation during the 1870s as part of the larger national movement embracing nature-appreciation and outdoor recreation. Camping continued largely unchanged through the 1910s, and it became an accepted recreational activity in the Rocky Mountains. Compared to resort tourism, few people camped at first, with most tending to be young, middle or upper class, and accustomed to the outdoors. The reasons for camping were similar to those for related outdoor activities: health, camaraderie, appreciation of the natural environment, and escape from the urban atmosphere.

Contemporary camping involved heavy and cumbersome equipment. Tourists needed several changes of rugged clothing, preferably wool, as well as hats, rain slickers, heavy boots, and items for entertainment. Because synthetic materials did not yet exist, most heavy camp equipment was wooden, iron, brass, leather, and canvas. Food was canned or dried, and beverages came in bottles. When pitched, the typical camp featured wall tents on earthen pads, a large fire ring surrounded by seating logs, a cooking area with masonry hearth or sheet-iron stove and portable tables. Frequently used campsites may have included an outhouse, food hutch, and even a roofed shelter. Tourists rarely arrived in the mountains with their own camping gear because the heavy and bulky equipment was too difficult to transport. Instead, they hired local packers and guides who knew where to go, had the equipment, and could set it up. Because the process of trekking to a site and helping with setup was lengthy, the tourists usually stayed several days to make the time investment worthwhile.

The automobile revolutionized camping. It allowed tourists to run their own expeditions by carrying equipment from home to destination autonomously (see Illustration A 7.5). The popularity of camping thus increased during the 1920s when automobiles became common among the affluent. Because automobiles were restricted to roads, property owners along principal routes in the mountains profited from these tourists. The entrepreneurs organized auto-friendly campgrounds that followed a general template in physical set-up. The campgrounds were usually sited off but near a main road, on flat land, and amid open forest. The operators dedicated one portion for primitive camping, providing earthen tent platforms, table, fire pit, and

⁶⁶⁴ Nelson 1999: 163-164.

⁶⁶⁵ Jensen and Guthrie 2006: 31

food locker. Forecasting that crude lodging would increase business, operators added rustic cabins, a masonry fireplace, roofed shelter, and toilets arranged around a pull-through drive.

As camping increased throughout the corridor, private interests and state and federal agencies built a number of campgrounds according to this template. During the 1910s and 1920s, the City of Denver established eight campgrounds in its Mount Evans park area with shelters, stone fireplaces, springs and pump houses, and tables and benches. The Forest Service added two more campgrounds in the area.⁶⁶⁶ Some municipalities saw economic value in attracting auto tourists and built their own campgrounds, exemplified by a project in Georgetown in 1927.

A new tourist camp is being prepared on Brownell Street almost directly below the turn on the Silver Plume road. A small building which stands will be fixed up so that visitors can get under cover in rainy weather. The grounds contain a number of fine large trees for shade and plenty of dry ground for camps. Running water from the city mains and comfort stations will also be supplied and when finished the new tourist camp will be equal in attractiveness to any in the state.⁶⁶⁷

In 1922 the federal government set aside \$10,000 for recreational development, primarily campground improvements in National Forests. Although the sum was modest, it was one of the government's earliest efforts to support recreation in the forests. The investment also reflected the growing importance of camping.⁶⁶⁸

As with other forms of outdoor recreation, the Great Depression and World War II fostered transition. Camping increased again in popularity because it was inexpensive and close to Front Range cities, while federal and state agencies built additional campgrounds through New Deal programs. For example, in addition to many miles of trails, the WPA built 124 recreation buildings in Colorado in the 1930s, including campground facilities.⁶⁶⁹ The general template in campground design and content remained nearly unchanged from previous decades.

The new campgrounds and their use during the 1930s were important for several reasons. First, camping became widely practiced in the Rocky Mountains. Second, campgrounds are lasting public assets that have provided several generations of tourists with designated places to recreate. Well built, many campgrounds are still in service today. Last, in building numerous campgrounds, state agencies and the Forest Service began a policy of providing the public with outdoor recreational facilities. As that policy became part of agency culture, the agencies managed their land proactively for recreational use and added more facilities. By 1940, Arapaho National Forest had sixty-five forest campgrounds and picnic areas and White River National Forest had thirty-three campgrounds and picnic areas.⁶⁷⁰

From the end of World War II to present, the trends and patterns established during previous decades flowered. Camping and related activities became part of a Rocky Mountain cultural identity as more people than ever recreated in the mountains. In response, private interests, state agencies, and the Forest Service completed additional campgrounds (for example through the Forest Service's Operation Outdoors initiative). The economic benefits were widespread. Tourists funneled money into mountain towns, depressed after their natural resource industries collapsed, helping some to recover. Tourist demand for camping equipment eventually fostered an outdoor retail sector large enough to interest department stores and support

⁶⁶⁶ Draper 1934: 13, 60.

⁶⁶⁷ *Georgetown Courier* (7/23/27): p1 c2.

⁶⁶⁸ Brockman and Merriam 1979:56; Wyckoff 1999:87.

⁶⁶⁹ Abbot 2000: 290-1.

⁶⁷⁰ U.S.D.A. Forest Service. *National Forest Vacations*. Pamphlet, U.S. Government Printing Service, 1940.

independent sellers as well as a number of specialty manufacturers in Colorado and other western states. Camping, part of a larger outdoor movement, has grown continuously both in number of participants and in frequency of trips. At present, camping is one of the most important recreational activities, economic contributors, and cultural and political influences in the corridor.



SECTION B: INTRODUCTION TO PROPERTY TYPES AND REGISTRATION REQUIREMENTS

Section B lists property types either known or likely to exist in the I-70 Mountain Corridor. The section is organized by historic theme, paralleling the order established in Section A, with one exception. Section B: Universal Architectural Property Types stands alone, listing universal building types occurring throughout the corridor, transgressing localized historic themes. The other subsections define principal property types, Periods of Significance, Areas of Significance, and registration requirements specific to their themes.

The subsections borrow select material from existing National Register Bulletins and Multiple Property Documentation Forms. To avoid repetition, the subsections do not reproduce text wholesale, instead referring readers to source publications. In mining, agriculture, railroads, and road transportation, other Multiple Property Documentation Forms have established precedent in terminology, property types, and registration requirements. Although produced for statewide use or specific regions outside the corridor, the descriptions and details regarding property types are generally applicable and therefore referenced but not repeated. Periods of Significance, Areas of Significance, and registration requirements have been adapted to corridor resources where appropriate.

National Register Bulletins offer guidance for recording and evaluating corridor resources, whole or in part, and are referred to as needed in the subsections. A few broadly applicable points, however, should be observed here.

- Pack Trails, roads, railroad grades, ditches, pipelines, and flumes should be recorded as linear resources, when segmented or continuous. Segments may be features within larger sites or complexes. To record and evaluate them as contributing elements of larger sites, see Appendix VI in National Register Bulletin 16A: *How to Complete the National Register Registration Form*.⁶⁷¹
- Large-scale sites often consist of numerous property types forming a greater whole. Cohesive assemblages of resources may qualify as historic districts when contributing elements and integrity sufficiently convey the Property Type and its significance. To describe and evaluate contributing elements, consult Appendix VI and p.16 in *How to Complete the National Register Registration Form*.
- Rural Historic Landscapes are defined as property types in the themes of mining, timber industry, agriculture, and railroads. Although Areas of Significance and registration requirements are offered in the subsections, landscapes are complex resources warranting further guidance in recordation and evaluation. See *National Register Bulletin: Guidelines for Evaluating and Documenting Rural Historic Landscapes* for more information.⁶⁷²
- Some property types in the corridor are rare, with few existing examples and none in as-built condition. Purposeful alterations, changes due to time, and other impacts to integrity may be acceptable provided enough of a property survives for it to be a significant resource. The relationship between resource rarity and level of integrity is discussed in

⁶⁷¹ *National Register Bulletin 16A: How to Complete the National Register Registration Form*. National Park Service, 1997 [1977].

⁶⁷² McClelland, Linda Flint, Keller, J. Timothy, Keller, Genevieve P., and Melnick, Robert Z. *National Register Bulletin: Guidelines for Evaluating and Documenting Rural Historic Landscapes*. National Park Service, 1999 [1989].

*National Register Bulletin 15: How to Apply the National Register Criteria for Evaluation.*⁶⁷³

- Historic churches, other religious buildings, and cemeteries exist in the corridor. In addition to meeting NRHP Criteria for eligibility, churches should also be evaluated under Criteria Consideration A and cemeteries under Criteria Consideration D. *National Register Bulletin 15: How to Apply the National Register Criteria for Evaluation* explains Criteria Considerations starting on p.25.

A single, broad Period of Significance encapsulates the I-70 corridor's long and complex history. The Period begins in 1859, when large numbers of Euro-Americans arrived, and ends in 1962, fifty years before this report was produced. Narrower Periods have been developed, as well, by theme and geographic area to enhance resource understanding and significance evaluation. Patterns of industry, settlement, transportation, and land use were not uniform in the corridor, varying in time and duration by principal drainage. Each geographic area and its narrower Periods of Significance are defined in Section A. Some themes, and their resources, may continue in significance after 1962, such as railroads, road transportation, and outdoor recreation. They can be reevaluated individually in the future as needed, or under broader Periods of Significance with further research and context. Resources may have achieved exceptional significance within the last fifty years, the cutoff timeframe for application of NRHP Criteria A-D. Examples include the Eisenhower-Johnson Memorial Tunnels, Vail Pass, and Glenwood Canyon sections of I-70. Resources less than fifty years old may qualify under NRHP Criteria Consideration G. Evaluation is complex, and readers must consult *National Register Bulletin 15: How to Apply the National Register Criteria for Evaluation*, p.41, for further guidance.

Between around 1965 and 2012, numerous historic resources have been recorded in the corridor. A few are listed on the NRHP, many have been evaluated for significance, while others remain unevaluated. In 2005, CDOT and FHWA commissioned a reconnaissance survey tabulating recorded resources by Smithsonian number, resource name, type, eligibility status, and general location. *Revised Reconnaissance Survey of the Interstate 70 Mountain Corridor Between Glenwood Springs and C-470 in Colorado* is available at OAHF and CDOT.⁶⁷⁴

Definitions for Resources and Site Features

- **Building**: A building is a construct with a roof and one or more walls, sheltering activities within an interior space. For a resource to qualify as a building today, most of its walls should stand intact.
- **Building Ruin**: A building qualifies as a ruin if the walls are no longer complete and the roof is gone. A ruin is a type of archaeological feature.
- **Structure**: A structure is a construct built to serve a specific purpose other than shelter. Structures may have been countersunk into the ground as with cisterns, associated with industrial processes, facilitated a flow of materials like ditches, or a component of land improvement such as a retaining wall.
- **Engineered Structure**: An engineered structure was built according to a design or plan, complex in itself, and often a component of a larger system. Some engineered structures were beneath the surface such as buried pipelines and culverts. Underground mine workings are an advanced form of subsurface engineered structures.

⁶⁷³ *National Register Bulletin 15: How to Apply the National Register Criteria for Evaluation*. National Park Service, 1991 [1990].

⁶⁷⁴ Federal Highway Administration and Colorado Department of Transportation. *Revised Reconnaissance Survey of the Interstate 70 Mountain Corridor Between Glenwood Springs and C-470 in Colorado*. 2005.

- Structure Ruin: Structures qualify as ruins when their components are mostly collapsed or missing. Ruins are archaeological features.
- Archaeological Feature: Archaeological features are a broad category encompassing most of a site's attributes other than buildings, structures, and objects. The category refers to manifestations above ground, while those below ground are subsurface features (see below). Archaeological features are distinct physical entities that often possess artifacts with interpretive value. Features commonly represent past buildings, structures, or other intentional constructs through material evidence. Examples include earthen platforms, foundations, ruins, depressions, topographic alterations, and debris. Archaeological features also can be the physical result of organic processes, and may not be the remnants of designed constructs. Placer workings, waste rock dumps, and refuse scatters are samples of such features. Collections of artifacts representing activity areas apart from buildings and structures fall within the general category.
- Subsurface Archaeological Feature: This group includes features below ground-surface. Subsurface ruins such as collapsed root cellars, intentionally buried artifact deposits like privy pits, and naturally buried artifact deposits exemplified by refuse dumps qualify.
- Object: Objects are individual, small-scale constructs that are easily moved. Some objects were designed for mobility, such as vehicles and portable mining equipment. Others were designed to be stationary, but were either self-contained or functioned independently, like some pieces of machinery. When a component of a system, a machine qualifies as a structural or engineering feature.
- Artifact: The category includes all man-made items lying around a site. Most artifacts associated with industrial resources can be categorized as structural materials, industrial debris, domestic refuse, or household items. Although artifacts are commonly attributable to archaeological features, they also constitute the physical makeup of buildings and structures. Artifacts are extremely important because they can help interpret the timeframe and function of an individual feature, or the history of an entire site and its people.

Section B 1: Mining Industry Property Types and Registration Requirements

Section B lists those mining-related Property Types common to the I-70 corridor. The Types are categorized by function: placer mining, hardrock prospecting, hardrock mining, ore treatment, and associated settlement. Descriptions of mining-related archaeological, structural, and architectural features are offered at the section's end to refine resource interpretation. The researcher should also review descriptions of mining methods and equipment in Section A 1.4, and universal building types in Section B 8 for greater context.

In a broad sense, some aspects of placer and hardrock mining were uniform throughout Colorado. Thus, for brevity, universal Property Types are noted below but refer the reader to two previous Multiple Property Documentation Forms for full text. Readers should consult *The Mining Industry in Colorado* (revised 2008), and *Historic Mining Resources of San Juan County, Colorado*.⁶⁷⁵ Inapplicable Property Types from both contexts were deleted, while those with characteristics specific to the I-70 corridor are discussed in full. Adaptation is with permission from authors Jay Fell and Eric Twitty.

The following Property Types and Subtypes are developed in this section:

- Placer Mine
 - Stream Placer
 - Gulch Placer
 - River Bar Placer
 - Hydraulic Placer
- Hardrock Prospect
 - Prospect Complex
 - Prospect Shaft
 - Prospect Adit
- Hardrock Mine
 - Shaft Mine
 - Tunnel Mine
- Ore Treatment Mill
 - Concentration Mill
 - Amalgamation Stamp Mill
 - Arrastra
- Smelter
- Prospectors' Camp
- Worker Housing
- Isolated Residence
- Mining Settlement
 - Unincorporated Settlement
 - Townsite
- Rural Historic Mining Landscape

⁶⁷⁵ Jay Fell and Eric Twitty *The Mining Industry in Colorado Multiple Property Documentation Form* Denver: Office of Archaeology and Historic Preservation, Colorado Historical Society, 2008; Eric Twitty *Historic Mining Resources of San Juan County, Colorado Multiple Property Documentation Form* Denver: Office of Archaeology and Historic Preservation, Colorado Historical Society, 2010.

PROPERTY TYPE: PLACER MINE

Placer mines were operations in which independent miners and capitalized companies alike processed stream gravel and soil for gold particles. As historic resources, placer mines should be distinguished from a larger collective known as placer workings. A placer mine was a specific property, usually defined by claim boundaries, where an individual or company worked for gold. Multiple mines, one after another often in series along a stream, can manifest as large acreages of tailings piles, pits, and infrastructure features. The entire assemblage was known as placer workings, and individual mines within can sometimes be identified through archival research and physical examination. In the event they cannot, all may be recorded today as a single historic resource.

Placer Mine Property Subtypes

Property Subtype: Gulch Placer: See *The Mining Industry in Colorado* and *Historic Mining Resources of San Juan County, Colorado*. (See Illustration B 1.1).

Property Subtype: Stream Placer: See *The Mining Industry in Colorado* and *Historic Mining Resources of San Juan County, Colorado*. (See Illustration B 1.2).

Property Subtype: River Bar Placer: River bar placers attracted the same spectrum of mining outfits as stream placers, and they employed like methods of development and production. As a result, river bar placers possess characteristics similar to stream placers. The principal difference is that river bar placers tend to be located along the sides of stream drainages instead of directly on the floors. Placers worked by small outfits usually manifest as excavations, tailings piles, minor gullies, and feed ditches. Large operations include ditch systems, distinct sluice beds, and dams for booming and feeding the sluices.

Property Subtype: Hydraulic Placer: See *The Mining Industry in Colorado* and *Historic Mining Resources of San Juan County, Colorado*. (See Illustrations B 1.3 and B 1.4).

Placer Mine Significance

Placer mining, a cornerstone of history in the I-70 corridor, participated in and was associated with numerous Areas of Significance. The trends and patterns include Community Planning and Development, Economics, Engineering, Exploration/Settlement, Industry, Law, and Politics/Government.

The Period of Significance 1859 to 1942 covers mining as a viable industry throughout the I-70 corridor. But narrower timeframes are more applicable to resources in Clear Creek drainage and the Dillon and Frisco area because these regions had different histories. Placer mining was important in Clear Creek drainage from 1859 to 1864, 1880 through 1895, and 1930 through 1942. The endeavor was also important in the area around Dillon between 1898 and 1913. Level of significance was local, but could be statewide for early mines, depending on further research.

Area of Significance: Community Planning and Development: *Community Planning and Development* was an important Area of Significance primarily in Clear Creek drainage from 1859 through 1864. The region's general settlement pattern began taking form during the first two years, but because it was mostly a function of exploration and prospecting, the pattern was in flux. The development of a placer mining industry during the latter years cemented the pattern, which then changed little afterward. During the period, all the drainage's principal settlements were established around concentrations of mines and grew into permanent administrative, communication, commercial, and social centers.

Area of Significance: Economics: Placer mining was significant in the Area of *Economics* in several ways, depending on timeframe and location in the I-70 corridor. During the first Period of Significance, from 1859 through 1864, Clear Creek placer miners participated in a larger wealth production movement including Boulder, Gilpin, Park, and Summit counties. In the movement, miners generated the first substantial output of monetary wealth in the Rocky Mountains and established the largest economy to date. That economy became the basic template for the natural resource-based system on which Colorado relied for the next 110 years. Also, placer mining made some individuals wealthy, supported a workforce with few other employment opportunities, and produced gold traded for supplies and equipment. In turn, the supplies and equipment supported further development of industry and permanent settlement.

Hydraulic mining was economically important in Clear Creek drainage from 1880 through 1895 and at Dillon from 1898 through 1913. The gold output, profits to investors, wages paid to labor, and purchase of supplies contributed to local commerce and economies. The consumption of goods and supplies also fostered the development of banking, retail businesses, and other commercial systems.

Placer mines that produced between 1930 and 1942 contributed to local and statewide economies at a time when income was dearly needed. During this period, Clear Creek drainage and greater Colorado suffered due to the Great Depression, the nation's worst economic disaster. When the Great Depression began in 1929, Clear Creek drainage already suffered severe poverty through lack of investment, high unemployment, and few sources of income outside of industry. The Depression worsened these conditions, forcing many people to leave. But those who remained returned to the old placers, previously thought exhausted, in hopes of finding enough gold for a subsistence-level income. The movement began slowly at first, increased in momentum in 1933 when President Roosevelt increased the value of gold, and became a substantial revival in 1934 with the Gold Reserve Act. Although a shadow of previous decades, the resuscitated mining industry provided jobs and income, stabilized the existing communities, and contributed to local economies at an important time of need.

Area of Significance: Engineering: Most company placer operations employed engineering to some degree for sluices, water systems, and processing methods. At small-scale operations, miners not formally trained in design tended to build vernacular structures and systems. In these cases, individuals adapted familiar design and construction principals to the specific conditions of their mines, available materials or equipment, and the immediate environment. Although inefficient, and simple, vernacular engineered structures and systems were important for several reasons. First, the structures and systems allowed many mining operations to function. Second, they provided examples followed by other miners. Last, the small mines, in their vernacular engineering, made up the bulk of the placer mining industry.

At large mines, trained engineers designed structures, systems, and placer workings according to principals practiced in the greater mining industry. Through professional planning, the structures, systems, and workings allowed the companies to process higher tonnages of lower grade gravel than was otherwise possible. In so doing, professional engineering prolonged placer mining, which then continued to support communities.

Area of Significance: Exploration/Settlement: Placer mines between 1859 and 1864 participated in *Exploration/Settlement* as physical anchors for the frontier movement in the central Rocky Mountains. When prospectors and miners arrived in significant numbers in 1859, they brought the mining frontier to the central mountains, previously the domain of Native American tribes. During the period, the prospectors and miners first established a baseline body of knowledge of geography and natural resources, defining areas with the highest concentrations of placer deposits. This information gave guidance to other miners, as well as investors willing to risk capital in the proven areas. Localized mining industries and settlement patterns quickly followed. Each local industry fostered the growth of settlements, dependent industries, commerce, and infrastructure. The overall movement resulted in the exploration, settlement, and industrialization of the central Rocky Mountains.

Area of Significance: Industry: The area of *Industry* applies differently by era and location. Placer workings dating from 1859 to 1864 were pioneering elements and building blocks of the mining industry. During this time, prospectors and miners established the basic requirements for mining to assume industrial proportions. At first, prospectors located and then began developing placer deposits. Outside investors followed, organizing companies that in turn purchased and improved the primitive operations. The profitable ventures inspired confidence among other investors, who felt encouraged to do likewise. Their capital, combined with the increasing numbers of people who journeyed to the region, became a mining industry. Cumulatively, individuals and companies, regardless of size or productivity, improved the transportation networks, reinforced the extant settlement patterns, contributed to local economies, and established commercial and communications systems.

The large placer mines operating in Clear Creek drainage and around Dillon after the early 1860s rush were also important in the area of industry. They were part of the industrial fabric in these regions, contributing to local economies, employing hundreds, drawing trained experts, and supporting businesses and development of infrastructure.

Areas of Significance: Law and Politics/Government: Placer mines were the reason why prospectors and miners were in Clear Creek drainage from 1859 through 1864, and those individuals participated in the development of early law and government. They organized the region's first mining districts, which codified laws, governing bodies, and documentation. The frontier legal system defined claim types, rights, and sizes; water rights; and crime and punishment. The Territorial Legislature then included many of the definitions and rights in its 1861 charter.

Placer Mine Registration Requirements

National Register-eligible placer mines must meet at least one of the NRHP Criteria below and possess sufficient physical integrity to convey property type and significance.

Criterion A: Placer mines eligible under Criterion A must be associated with at least one Area of Significance noted above, as well as events and trends important in their host segment of the I-70 corridor.

Criterion B: Placer mines may be eligible under Criterion B when directly associated with the life of an important person significant in our past. The individual may have been engaged working gravel at small mines, and as labor, on-site management, or an engineer at company-run placers. A brief biography is necessary to detail the individual's significant contributions. In some cases, important people invested in or owned placer operations but did not occupy the property. Such an association does not meet Criterion B registration requirements. The individual of note must have been present on-site. Applying Criterion B is complex, and *National Register Bulletin 32: Guidelines for Evaluating and Documenting Properties Associated with Significant Persons* can provide further guidance.

Criterion C: For eligibility under Criterion C, the resource must clearly represent one of the placer mine types and retain integrity relative to one of the Periods of Significance outlined above. Character defining features at gulch, stream, and river bar placers include excavations, tailings piles, work stations, and aspects of infrastructure. Hydraulic placers may exhibit systems of water allocation and distribution, including ditches, pipeline beds, and pressure boxes. Mining methods are likely conveyed through monitor stations, sluice beds, and booming dams. The workings themselves should resemble those developed by hydraulic methods, with high cut-banks, scoured basins, tailings mounds, and large outwash fans. In general, well-preserved placer mines and associated structures are rare because they tend to exist in unstable environments. Thus, a resource's features and artifacts possess enough physical integrity when they clearly convey the mine type, but all elements need not be present.

Placer mines may be eligible under Criterion C as contributing elements of historic mining landscapes. Even when a site is not completely intact in itself, its workings may contribute to the setting and feeling of an area. Some sites could be extensive enough to constitute localized landscapes in themselves.

Criterion D: Placer mines may be eligible under Criterion D if highly likely to yield important information upon further study. Studies of infrastructure features, including water allocation and distributions systems, sluice beds, and work areas may enhance current understanding of engineering adapted to placer mining. If the resource possesses building platforms, testing and excavation of buried archaeological deposits may reveal information regarding workforce lifestyle, social structure, and environment, as well as the functions of ancillary buildings.

Placer mines must retain physical integrity relative to one of the Periods of Significance mentioned above. Because buildings and structures were either removed or destroyed after abandonment, integrity will probably be on an archaeological level. For eligibility, the archaeological features and artifacts must clearly embody the type of placer mine; its operating

timeframe; and content including workings, ditches, and sluice beds. Common resource features are noted at the section's end.

The most applicable aspects of historic integrity will be *design*, *setting*, *feeling*, and *association*. A resource retains integrity of *design* when the overall feature assemblage and individual feature systems reflect the layout, content, and directed evolution of the mining operation. Integrity of *setting* requires the ground around the resource, and the resource itself, to appear similar today as when the mine operated. If the placer was isolated, then the natural environment should be preserved. If the site is in a mining landscape, then nearby placer mines and other resources should retain integrity at least on an archaeological level. In terms of *feeling*, the resource should convey the sense or perception of placer mining, both from a historical perspective and from today's standpoint. Integrity of *association* exists where placer workings, structures, and other features firmly convey a connection between the property and a contemporary observer's ability to discern the historic placer operation.

PROPERTY TYPE: HARDROCK PROSPECT

See *The Mining Industry in Colorado* and *Historic Mining Resources of San Juan County, Colorado*.

Hardrock Prospect Subtypes

Property Subtype: Prospect Complex: See *The Mining Industry in Colorado* and *Historic Mining Resources of San Juan County, Colorado*.

Property Subtype: Prospect Shaft: See *The Mining Industry in Colorado* and *Historic Mining Resources of San Juan County, Colorado*. (See Illustration B 1.5).

Property Subtype: Prospect Adit: See *The Mining Industry in Colorado* and *Historic Mining Resources of San Juan County, Colorado*.

Hardrock Prospect Significance

Hardrock prospecting was fundamental to I-70 corridor history. Prospecting was an essential step in finding and defining ore formations on which the mining industry was founded. That industry, in turn, was the principal engine for most of the settlement, transportation networks, dependent industries, land use patterns, and other trends throughout the corridor. The principal Areas of Significance include: Architecture, Community Planning and Development, Engineering, Exploration/Settlement, Industry, and Politics/Government.

The Period of Significance 1859 through 1942 covers mining as a viable industry throughout the I-70 corridor, but narrower timeframes are more applicable by region. Prospecting, the search for profitable ore, generally occurred during the formative years of a mining industry, which differed in Clear Creek drainage and the Dillon and Frisco area. Further, the Periods of Significance for prospecting in Clear Creek drainage differed for gold and silver.

Prospecting for gold was important throughout the entire drainage from 1859 through 1864. The search for gold then contracted to the eastern portion, from Floyd Hill west to Empire, between 1865 and 1910. Silver prospecting was important in the western drainage, from Empire west to Loveland Pass, between 1864 and 1893. Prospecting was significant in the area around Dillon and Frisco between 1878 and 1885 and again from 1897 through 1905.

Area of Significance: Architecture: Standing buildings associated with prospects are significant in the Area of Architecture. Individual prospectors as well as mining companies adapted conventional designs and construction to the physical environment and available materials. Most buildings were vernacular, influenced by the builder's financial resources, needs, skills, and experience.

Area of Significance: Community Planning and Development: *Community Planning and Development* was an important Area of Significance in Clear Creek drainage from 1859 through 1890 and in the Dillon and Frisco area from 1878 through 1885. During these periods, some settlements were a function largely of prospecting, thriving and then declining in parallel. Settlements such as Bakerville and Silver Creek in Clear Creek drainage, and Wheeler in Ten Mile Canyon, were established near concentrations of prospects and grew into communication, commercial, and social centers. They withered when prospecting ended, reflecting the general evolution of settlement patterns related to the mining industry.

Area of Significance: Engineering: *Engineering* applies to planning and organization of prospect complexes, as well as to individual structures and designed systems at shafts and adits. When excavating pits and trenches at prospect complexes, experienced individuals often implemented a methodical sampling and examination strategy. They may have planned grids, rows, or triangular configurations of pits and trenches. Prospectors also employed engineering to some degree when developing shafts and adits. They adapted known technology, shaft or adit design, and development methods to primitive environmental conditions including difficult terrain, inaccessibility, unknown geological conditions, and an undeveloped landscape. Prospect outfits also adapted geological knowledge and technology to make sense of and predict the occurrence of mineral formations and ore in uncharacterized regions. In so doing, they collectively contributed to the understanding of regional economic and structural geology and mineralogy.

Area of Significance: Exploration/Settlement: Prospects participated in *Exploration/Settlement* as physical anchors for the mining frontier in the central Rocky Mountains. Individual prospectors and prospect outfits were on the forefront of the frontier, laying groundwork for the establishment of regional mining industries. They were usually the first to conduct extensive physical and mineralogical exploration, relaying information critical to subsequent mining interests and settlers. Prospectors and outfits were also among the first Euro-Americans to inhabit the I-70 corridor, bringing with them political, economic, and social systems. Localized mining industries and settlement patterns then quickly followed. The overall movement resulted in exploration, settlement, and industrialization of the central Rocky Mountains.

Area of Significance: Industry: The initial growth and development of the mining industry was a movement beginning with prospecting. Prospectors were first to locate and develop hardrock veins, which outside investors subsequently purchased and improved. Although most failed,

some became profitable and in turn inspired confidence among other investors, who felt encouraged to do likewise. Their capital, combined with numerous other prospectors, people, and regional development became a mining industry. Cumulatively, individuals and the companies, regardless of size, improved transportation networks, reinforced extant settlement patterns, contributed to local economies, and established commercial and communications systems.

Area of Significance: Politics/Government: The Area of Significance applies primarily to prospects in Clear Creek drainage dating from 1859 through 1864. The prospectors participated in organizing the region's earliest mining districts, which codified laws, governing bodies, and documentation. The frontier legal system defined hardrock claim types, rights, and sizes and also crime and punishment. The Territorial Legislature then included many of the definitions and rights in its 1861 charter.

Hardrock Prospect Registration Requirements

National Register-eligible prospects must meet at least one of the NRHP Criteria below and possess enough physical integrity to represent Property Types and significance.

Criterion A: Prospects eligible under Criterion A must be associated with at least one Area of Significance noted above, as well as events and trends important in their host segment of the I-70 corridor.

Criterion B: Prospects may be eligible under Criterion B through direct association with the life of an important person. The resource must retain physical integrity relative to the person's productive period in life. They may have established presence personally excavating ground, as general labor, or on-site management. A brief biography is necessary to detail the individual's significant contributions. In some cases, important people invested in prospect operations or owned claims but did not occupy the property. Such an association does not meet Criterion B registration requirements. The individual of note must have been present on-site. Applying Criterion B is complex, and *National Register Bulletin 32: Guidelines for Evaluating and Documenting Properties Associated with Significant Persons* can provide further guidance.

Criterion C: Prospect complexes may be eligible under Criterion C if they are good examples of organized and planned prospect efforts. In eligible complexes, the assemblage of excavations should conform to a systematic pattern, and if support facilities such as a blacksmith shop existed, then evidence should be clear. Integrity requirements are high because prospect complexes are a common resource type and many examples exist statewide.

Prospect shafts and adits may be eligible under Criterion C if they are outstanding examples of their resource type. Because most equipment and buildings were removed when an operation was abandoned, integrity is usually on an archaeological level. At shafts, the hoisting system, blacksmith shop, and other facilities should be represented by features and artifacts. At adits, the shop and transportation system used from portal to surface must be discernible. Integrity requirements are high because prospect shafts and adits are common resource types, with many examples statewide. By contrast, intact buildings, structures, equipment, adit portals, and shaft collars are rare and important.

Prospects are potentially eligible under Criterion C when they are contributing elements of historic mining landscapes. Even when a resource is not completely intact in itself, its waste rock dump may contribute to the setting and feeling of an area.

Criterion D: A prospecting resource may be eligible under Criterion D if it will likely yield important information upon further study. When the assemblage of excavations in a prospect complex is mapped in detail, they may reveal sampling strategies and patterns employed by experienced individuals. If a shaft or adit site possesses intact structures and buildings, detailed examination may reveal how prospect outfits adapted conventional mining architecture and engineering to Colorado's mining frontier. Few studies within these arenas of inquiry have been completed to date.

If workers lived on-site, the residential area may offer meaningful buried archaeological deposits such as privy pits. Testing and excavation could exhume artifacts capable of illuminating the currently dim portrait of the types of workers employed at prospect operations, and how they lived.

Prospects must retain physical integrity relative to one of the Periods of Significance mentioned above. Because buildings and structures often decayed or were removed after prospecting stopped, integrity will probably be on an archaeological level. To be eligible, the archaeological features and artifacts must clearly embody the prospect type, its operating timeframe, and content including workings and support facilities.

Applicable aspects of NRHP historic integrity will be *location, design, setting, feeling, and association*. Not all need be present. Intact buildings, structures, and machinery must be in their original places of use to retain integrity of *location*. A resource retains integrity of *design* when the overall feature assemblage reflects the layout, content, and directed evolution of the prospect operation. Integrity of *setting* requires the terrain around the prospect, and the resource itself, to appear similar today as when it was developed. If the prospect was isolated, then the natural environment should be preserved. If the resource is in a mining landscape, then nearby mines and other resources should retain integrity at least on an archaeological level. In terms of *feeling*, the resource should convey the sense or perception of mineral exploration, both from a historical perspective and from today's standpoint. Integrity of *association* exists in cases where prospect workings, structures, and other features convey a connection between the property and a contemporary observer's ability to discern the historic operation.

PROPERTY TYPE: HARDROCK MINE

See *The Mining Industry in Colorado* and *Historic Mining Resources of San Juan County, Colorado* for an overview description. When assessing the significance of tunnel and shaft mines, rarity should be weighed. Small to moderate-sized mines are common resources. Integrity requirements are thus high. Resources with intact buildings or structures, or with high integrity on archaeological level are uncommon and possibly important. Large, complex mines are uncommon, and those retaining sound integrity are rare and possibly important. See B 1.6-B 1.9 for examples of typical mines.

Hardrock Mine Subtypes

Property Subtype: Shaft Mine: See *The Mining Industry in Colorado* and *Historic Mining Resources of San Juan County, Colorado*.

Property Subtype: Tunnel Mine: See *The Mining Industry in Colorado* and *Historic Mining Resources of San Juan County, Colorado*.

Hardrock Mine Significance

Historic mines in the I-70 corridor are associated with the NRHP Areas of Significance Architecture, Commerce, Community Planning and Development, Economics, Engineering, Exploration/Settlement, Industry, Law, and Politics/Government.

The Period of Significance 1859 through 1942 covers mining as a viable industry throughout the I-70 corridor, but narrower timeframes are more applicable by region. The industries in the Dillon and Frisco area and Clear Creek drainage were separate in chronology and ore type, which influenced cycles of production and dormancy. Hardrock gold mining was important throughout Clear Creek drainage from 1859 through 1864. Gold production declined for a time, replaced by silver in the western drainage from Empire west to Loveland Pass. Silver mining was significant from 1865 through 1920. Meanwhile, gold production resumed in the eastern drainage, from Floyd Hill west to Empire, in 1873. Gold mining remained important in this region through 1918. The industry was largely quiet and unimportant during the 1920s but resumed significance from 1930 through 1942. Hardrock mining was significant in the area around Dillon and Frisco during three time periods. The first spanned 1878 through 1885, the second 1890 into 1893, and the last 1898 until 1920.

Area of Significance: Architecture: Mines with standing buildings may be important in the Area of *Architecture* for several reasons. At small and early operations, miners adapted familiar building designs and construction methods to meet the needs of work underground in frontier conditions. They responded to topography, natural landscape features, local climate, and impediments in access. Economic constraints and available buildings materials also influenced adaptation of design and methods. The buildings tended to be simple, crude, and assembled with logs, lumber, and canvas. In constructing these types of buildings, miners contributed to existing patterns of functional and yet cost-effective frontier mining industry architecture.

Later in time, engineers and experienced miners contributed to the development and evolution of architecture for mining in the mountains. Miners and engineers adapted general industrial architecture practices and concepts to the needs of a mine and its environmental conditions. Some buildings such as shaft houses and tunnel houses were custom-designed but followed a template specific to mining in the mountains. In other buildings, miners and engineers adapted familiar forms and methods but added features to fulfill required functions and duties.

Area of Significance: Commerce: The mining industry was significant in the Area of *Commerce* because it fostered complex regional commercial and economic systems. In one trend, Clear Creek drainage companies shipped crude ore and concentrates to smelters in Black Hawk, Golden, Denver, and even Colorado Springs. The outfits in Summit County sent ore to Leadville,

Denver, and also Colorado Springs. The transactions supported a regional economy, and wed the mining industry with railroads and smelting centers.

In another trend, the industry supported businesses and the production, distribution, and sale of goods. Mining companies hired contractors for various services such as surveying and drayage, and purchased some materials including lumber and hardware from local suppliers. Companies also acquired large machinery and other industrial goods from manufacturers mostly in Denver, and to a lesser degree from outside of Colorado. The manufacturers in Denver in turn purchased their materials from sources within and outside of Colorado. In so doing, mining companies supported primarily Colorado's and secondarily other economies. Further, they helped Denver maintain its status as one of the most important mine supply and machinery manufacturers in the Rocky Mountains. Successful manufacturers including Colorado Iron Works, Denver Foundry & Machine Shop, Hendrie & Bolthoff, and Mine & Smelter Supply Company among others called Denver home. It should be noted that large mines had a more pronounced influence in these trends than the small ones.

Area of Significance: Community Planning and Development: Hardrock mines participated in the Area of *Community Planning and Development* as anchors for the towns of Frisco, Curtin, and Wheeler in Summit County and most of the communities in Clear Creek drainage. The settlements were established because of the industry and depended on it for existence, paralleling the industry's rise and decline. Community activists planned growth and instituted important services and infrastructure when nearby mines did well. Conversely, communities contracted, revising services and infrastructure when the industry struggled.

Area of Significance: Economics: The mining industry was significant in the Area of *Economics* for bringing wealth into their regions and directly supporting economies. Wealth came from two general sources: invested capital and income from converting natural resources into cash products. Mining companies diverted large portions of the money into local economies through workers' wages, fees to contractors, and acquisitions of supplies and materials. The money became a foundational element of most communities in Clear Creek drainage, as well as Dillon, Frisco, and satellite hamlets. It should be noted that large operations had a greater association with these trends than the small ones.

Area of Significance: Engineering: *Engineering* applies to planning and organization of individual structures, designed systems, or entire mines. Most mining operations adapted engineering principals in organizing underground workings and arranging surface plants. Engineering tended to be primitive and vernacular at the small operations but advanced and professional at large mines. Vernacular engineering refers to structures and systems built by individuals who were not formally trained in design. The individuals adapted familiar design and construction principals to the specific needs of their mines, available materials or equipment, and the immediate environment. Although functional, vernacular engineered structures and systems tended to be impermanent, inefficient, and small in scale. They were important, however, by allowing many mines to function. Further, the small mines, in their vernacular engineering, made up the bulk of the mining industry.

At substantial mines, trained engineers designed structures, systems, and underground workings according to principals established in the greater mining industry. With efficient planning, the companies produced higher tonnages of lower grade ore from deeper workings than

was otherwise possible. In so doing, professional engineering prolonged the lives of many mines and their dependent communities.

Broadly, Clear Creek drainage was a cradle for important technological and engineering developments in the field of hardrock mining. During the 1870s, engineers at Silver Plume and Georgetown contributed to systematic vein development from the bottom up, blocking out in sections for efficient extraction. The practice culminated in a phase of deep tunneling during the 1890s and first decade of the twentieth century, with the Newhouse Tunnel as one of the nation's longest mine tunnels at the time. The Newhouse and similar tunnels also were models of a combined engineering and business strategy. The tunnels were designed to undercut independent mines and provide their owners with access at depth. The tunnel companies then leased rights-of-way to those owners, who shared the tunnels for drainage and ore extraction. The lease income offset the costs of driving the tunnels.

The adaptation of electric power to mining was another important contribution. The Kohinor & Donaldson Mine at Lawson built one of the earliest electrical plants in Colorado in 1883. The drainage also received an Alternating Current grid during the 1890s when that technology was formative. Mining engineers then applied the empirical knowledge elsewhere.

Engineers at Silver Plume and Georgetown pioneered the use of mechanical rockdrills for boring blast-holes underground. Drills were tested, used, and then modified at the Burleigh Tunnel during the late 1860s and adopted at neighboring mines within a short time. The greater mining industry gradually adopted rockdrills during the next several decades.

Area of Significance: Exploration/Settlement: The Area of *Exploration/Settlement* applies to mines dating between 1859 and 1880 in Clear Creek drainage and 1878 and 1885 in the Dillon and Frisco area. During these periods, mines were physical anchors for the frontier in the central Rocky Mountains. Miners penetrated most of the region, quantifying its general geography and economic geology. Through claim examination, sampling, and development, they defined areas with concentrations of veins and ore bodies. This information in turn guided investors and companies in acquisitions and development. Localized mining industries and associated settlement patterns then quickly followed. The overall movement resulted in the exploration, settlement, and industrialization of the central Rocky Mountains.

Area of Significance: Industry: Mines were important in the Area of *Industry* as elemental building blocks of the mining industry. During the earliest years in Clear Creek drainage and the Dillon and Frisco area, mining companies were on the forefront of the frontier, bringing social, economic, governmental, and transportation systems. As the industry grew, it became one of the most important forces shaping history in the central mountains. The industry was the largest employer, supported most of the communities, fostered commerce, drew railroads, and influenced politics and government. By producing an enormous amount of gold, silver, and industrial metals, the industry supported regional economies and was the foundation of Euro-American settlement, outliving the industry itself.

Area of Significance: Law: A substantial number of mines in Clear Creek drainage were materially involved in the development of mining law. Prior to 1872, federal and territorial law had few provisions for addressing legal disputes between mine owners, leaving room for lawyers to interpret the sparse statutes. Passage of the 1872 Mining Law attempted to resolve gaps and standardize regulations but complicated some types of conflicts. Between 1864 and 1880, the

western drainage became a battleground among hostile and competing mine owners suing and countersuing over a variety of issues. The cases, court decisions, and lawyers set legal precedents in mining property rights, preemption, title to ore formations, and other definitions important to the industry. Also, a high volume of suits and cases gave rise to lawyers specializing in mining litigation. Applying the Area of Significance to specific resources requires further research regarding disputes, rulings, associated contributions to law, and involved legal professionals.

Area of Significance: Politics/Government: Mines in Clear Creek drainage dating from 1859 through 1864 are associated with the Area of Significance as physical anchors for early mining districts. The drainage's districts, among the earliest in Colorado, were frontier legal systems defining hardrock claim types, rights, and sizes, and crime and punishment. When the Territorial Legislature established its charter in 1861, it included many of definitions and rights developed in Colorado's mining districts.

Hardrock Mine Registration Requirements

For eligibility to the NRHP, historic mine sites must meet at least one of the Criteria below and possess sufficient physical integrity to convey their Property Type and significance.

Criterion A: Mines eligible under Criterion A must be associated with at least one Area of Significance noted above, as well as events and trends important in their host segment of the I-70 corridor.

Criterion B: Mines may be eligible under Criterion B if they are directly associated with the life of an important person significant in our past. Presence will most likely be through residence, employment, on-site management, or other involvement with the mining operation. The site must retain integrity relative to the person's productive life. A brief biography is necessary to detail the individual's significant contributions. Important people often invested in mines, directed companies, or owned claims but did not occupy the property. Such an association does not meet Criterion B registration requirements. The individual of note must have been present on-site. Applying Criterion B is complex, and *National Register Bulletin 32: Guidelines for Evaluating and Documenting Properties Associated with Significant Persons* can provide further guidance.

Criterion C: Mine sites may be eligible under Criterion C if they are good examples of their type. Because most equipment and buildings were removed when a mine was abandoned, integrity is usually on an archaeological level. The overall organization, design, and content of the mine's surface plant should be evident, and the site must possess features characteristic of its type. At shaft mines, the hoisting system, blacksmith shop, waste rock dump, and ore storage facilities should be discernible. Similarly, the tunnel house and associated facilities should be evident at tunnel mines. Intact buildings, structures, equipment, tunnel portals, and shaft collars dating to the site's Period of Significance are rare and possibly significant.

Mine sites are potentially eligible under Criterion C when they are contributing elements of historic mining landscapes. Even when a site is not completely intact in itself, its waste rock dump or topographic features may contribute to the setting and feeling of an area. Some sites may be extensive enough to constitute localized landscapes in themselves.

Criterion D: A mine may be eligible under Criterion D if it will likely yield important information upon further study. If the site possesses building platforms, privy pits, and boiler-clinker dumps, testing and excavation of these buried archaeological deposits may reveal information regarding miners' lifestyles, social structures, and the workplace, which are important areas of inquiry. Accessible and intact underground workings are important because few formal studies have been carried out regarding the underground work environment, engineering, equipment, and practices of drilling, blasting, and removing rock (see Illustration B 1.10). Historical documentation is currently the principal body of information that researchers rely on for studying the above aspects of mining. Detailed studies of structures and machinery can contribute information regarding engineering and architectural practices and the application of technology.

Eligible mines must possess physical integrity relative to one of the Periods of Significance outlined above. Because most small mines possessed few structures and little machinery, usually salvaged when a site was abandoned, integrity will probably be on an archaeological level. Archaeological remains retain sufficient integrity when they permit the virtual reconstruction of the mining operation, its timeframe, and convey the site's significance (see Illustrations B 1.11 and B 1.12).

Most of the seven aspects of historic integrity defined by the NRHP apply to mine sites. Some sites may possess buildings, structures, or intact machinery, which must retain integrity of *location* to contribute to a resource's integrity. For integrity of *location*, the structure or machine should have been present when the mine operated. For a resource to retain *design*, the resource's material remains, including the archaeological features, must convey the mine's organization, planning, and engineering. In many cases, mines were worked periodically and the surface facilities changed and adapted to new operations, leaving evidence of sequential occupation. In such cases, a resource can retain *design* if the material remains reflect its evolution over time. To retain integrity of *setting*, the area around the mine, and the resource itself, must appear similar today as when it was developed. If the resource is isolated, then the natural landscape should be preserved. If the resource lies in a mining landscape, then the surrounding mines and industrial features should retain integrity at least on an archaeological level. In terms of *feeling*, the resource should convey the sense or perception of mining from a historical perspective and from today's standpoint. Integrity of *association* exists where mine structures, machinery, and other features remain to convey a strong sense of connection between mining properties and a contemporary observer's ability to discern the historic activity that occurred at the location.

PROPERTY TYPE: ORE TREATMENT MILL

One of the main objectives of mining is reducing ore to its constituent metals. In a multistage process, treatment involved crushing and grinding crude ore to sand and slurry, and separating out metalliferous material from waste. Most of the payrock produced in the first five years of mining was known as free-milling and free-gold ore. The material was simple in form and the gold readily amalgamated with mercury. Because of this, companies erected what were categorically known as *amalgamation mills* to recover the gold. Most mills employed a battery of stamps to crush the crude ore into a slurry, which flowed over slanted amalgamation tables at

the battery's toe. The amalgamation tables, coated with mercury, recovered the gold. Because of its simplicity and relatively low cost, the amalgamation mill was within economic reach of many mining companies. Independent operators also provided custom treatment for companies unable to afford their own mills.

With depth underground, mining companies found the ore became increasingly complex, presenting great challenges to mill operators. The gold and host rock, known as gangue, featured minerals interfering with amalgamation, the mills thus recovering only a small percentage of gold. Such ore had to be treated in a primary smelter, which crushed the ore, separated out as much waste as possible, and melted the material in a furnace, yielding a blend of metals known as matte. For silver and industrial metals, smelting was the only effective treatment method. Advanced smelters at Black Hawk, along Colorado's piedmont, and in the Midwest were able to refine the matte into pure metals.

But few companies were willing to build their own smelters due to great cost, and also because smelters were difficult to design and had high failure rates. Investors found a partial answer in *concentration mills*, completing the preliminary crushing and separation steps ordinarily carried out by smelters. Concentration mills relied on combinations of mechanical and sometimes chemical methods to separate metalliferous material from gangue (see Illustration B 1.13). The facilities, also known as *reduction mills*, produced concentrates only and no refined metals, with the product shipped to a smelter for final treatment. The mills saved mining companies money in two areas. First, the companies did not incur high transportation costs of shipping waste-laden ore to a distant smelter, and second, they avoided the fees charged by smelters for complete treatment. Concentration mills saw increased use in the corridor during the mid-1870s, replacing most of the simple amalgamation mills by the 1890s.

Both concentration and amalgamation stamp mills operated in the I-70 corridor either as independent plants or in conjunction with specific mines. A third type of mill, the arrastra, was used in Clear Creek drainage during the 1860s and the 1870s, and rarely afterward. The three types are described in detail in Section A 1.4 and *The Mining Industry in Colorado Multiple Property Documentation Form*.

Ore Treatment Mill Subtypes

Property Subtype: Concentration Mill: See *The Mining Industry in Colorado* and *Historic Mining Resources of San Juan County, Colorado*.

Property Subtype: Amalgamation Stamp Mill: See *The Mining Industry in Colorado* and *Historic Mining Resources of San Juan County, Colorado*.

Property Subtype: Arrastra: See *The Mining Industry in Colorado* and *Historic Mining Resources of San Juan County, Colorado*. See Illustration B 1.14 for an example.

Ore Treatment Mill Significance

Ore treatment mills played a key role in the long-term success of hardrock mining in the I-70 corridor by reducing crude ore, as extracted from the ground, into an economical commodity. Without local ore treatment, mining companies would have been limited only to

those grades of payrock that were profitable enough to ship to distant smelters, and such material was in limited supply. The Areas of Significance relevant to treatment mills are: Architecture, Commerce, Community Planning and Development, Economics, Engineering, and Industry.

The Period of Significance 1859 through 1942 covers mining as a viable industry throughout the I-70 corridor, but narrower timeframes are more applicable by region and mill type. Arrastras were important in eastern Clear Creek drainage from 1859 until around 1870. Amalgamation stamp mills were important in eastern Clear Creek drainage from 1860 through 1890. Concentration mills were important throughout the drainage from 1875 through 1920, and again from 1930 through 1942. Concentration mills were significant in the area around Dillon and Frisco from 1898 until 1920.

Area of Significance: Architecture: Mills with standing buildings may be important in the Area of *Architecture* for several reasons. At early plants, operators adapted familiar building designs and construction methods to shelter ore treatment processes and machinery. They responded to environmental conditions including topography, natural landscape features, and local climate. Frontier conditions such as economic constraints and available building materials also influenced adaptations in designs and methods. Most early buildings tended to be simple, crude, and assembled with logs and lumber. In constructing these types of buildings, the operators contributed to existing patterns of functional and yet cost-effective frontier mining industry architecture.

At large complexes, engineers and metallurgists contributed to the development and evolution of architecture for mining in the mountains. Metallurgists and engineers adapted general industrial architecture practices and concepts to then-current ore treatment processes and equipment. The building enclosing treatment processes were custom-designed but followed a template characteristic of mining in the mountains. In other buildings, miners and engineers adapted familiar forms and methods but added features to fulfill required functions and duties.

Area of Significance: Commerce: Mills were significant in the Area of *Commerce* by facilitating the long-term success of the mining industry, which in turn fostered complex regional commercial and economic systems. In one trend, Clear Creek drainage companies shipped mill concentrates to smelters in Black Hawk, Golden, Denver, and even Colorado Springs. The mills in Summit County sent concentrates to Leadville, Denver, and also Colorado Springs. The transactions supported a regional economy, and wed the mining industry with railroads and smelting centers.

In another trend, the industry supported businesses and the production, distribution, and sale of goods. Mining companies hired contractors for various services such as surveying and drayage, and purchased some materials including lumber and hardware from local suppliers. Companies also acquired large machinery and other industrial goods from manufacturers mostly in Denver, and to a lesser degree from outside of Colorado. The manufacturers in Denver in turn purchased their materials from sources within and outside of Colorado. In so doing, mining companies supported primarily Colorado's and secondarily other economies. Further, they helped Denver maintain its status as one of the most important mine supply and machinery manufacturers in the Rocky Mountains. Successful manufacturers including Colorado Iron Works, Denver Foundry & Machine Shop, Hendrie & Bolthoff, and Mine & Smelter Supply Company among others called Denver home. It should be noted that large mines had a more pronounced influence in these trends than the small ones.

Area of Significance: Community Planning and Development: Ore treatment mills participated in *Community Planning and Development* through presence at Frisco in Summit County, and most of the communities in Clear Creek drainage. Mill operators sited their plants in these communities to be near a workforce, shipping points, water, and commerce. The mills then reinforced existing community development patterns, establishing the communities as local ore treatment centers.

In a broad sense, the settlements were a function of mining, made possible by mills, paralleling the industry's rise and decline. Community activists planned growth and instituted important services and infrastructure when nearby mines did well. Conversely, communities contracted and revised services and infrastructure when the industry struggled. In general, large mills are more allied with the trend than small operations because they were substantial employers and economic contributors.

Area of Significance: Economics: Through its mills, the mining industry was significant in the Area of *Economics* for bringing wealth into their regions and directly supporting economies. Wealth came from two general sources: invested capital and income from converting natural resources into cash products. Mining companies diverted large portions of the money into local economies through workers' wages, fees to contractors, and acquisitions of supplies and materials. The money became a foundational element of most communities in Clear Creek drainage, as well as Dillon, Frisco, and satellite hamlets. It should be noted that large operations had a greater association with these trends than the small ones.

Area of Significance: Engineering: *Engineering* applies to planning and organization of individual structures, designed systems, or entire mills. Engineering was primitive and vernacular at the small operations, especially arrastras, but advanced and professional at large mills. Vernacular engineering refers to structures and systems built by individuals who were not formally trained in metallurgy and mechanics. The individuals adapted familiar designs and construction principals to their interpretation of ore treatment, to available materials or equipment, and the immediate environment. Although functional, vernacular engineered structures and systems tended to be impermanent, inefficient, and small in scale. They were important, however, because they allowed many mills to function, despite difficult environmental conditions and lack of capital.

At medium-sized and large mills, trained engineers and metallurgists adapted standard ore treatment principals to the character of the ore, expected tonnage, and available equipment and materials. Their interpretations were expressed as mill design, treatment flow path, small-scale structures, and, ultimately, success. Working capital, environmental conditions, and then-current processes heavily influenced how metallurgists built their mills. When a mill was planned well, it enabled mining companies to produce higher tonnages of lower grade ore from deeper workings than was otherwise possible. In so doing, successful mill engineering prolonged the lives of many mines and their dependent communities.

In solving problems posed by complex gold and silver ore, metallurgical engineering was crucial to long-term success of the mining industry. Without engineering, the industry would have declined at an early time. The complex gold and silver ores defied conventional metallurgical practices and those methods proven to be effective in other regions. In combining experience with calculation, metallurgists devised processes rendering the complex ores

economically viable. When specific processes and mill appliances proved inadequate, Clear Creek metallurgists modified existing processes and equipment or invented new apparatuses. Ore concentration was on the forefront of a movement away from simple and labor-intensive methods to advanced and highly mechanized processes, permitting the separation of multiple metals in economies of scale. This involved the coordination of testing and treatment methods, complex mechanical systems, and hundreds of workers in massive facilities featuring multiple buildings. The ability to treat large tonnages of low-grade ore was crucial for the mining industry because it rendered previously uneconomical payrock profitable, extending the viability of individual mines as well as entire mining districts.

Area of Significance: Industry: Mills were important in the Area of *Industry* through their direct support of ore production. During the earliest years in Clear Creek drainage, mines and mills were on the forefront of the frontier and encouraged social, economic, governmental, and transportation systems. Arrastras were especially relevant in this trend, helping the industry to gain a foothold during early years. The industry grew, becoming one of the most important forces shaping history in the central mountains. The industry was the largest employer, supported most of the communities, fostered commerce, drew railroads, and influenced politics and government. By producing an enormous amount of gold, silver, and industrial metals, the industry supported the regional economy. The industry also was the foundation of Euro-American settlement, outliving the industry itself.

Ore Treatment Mill Registration Requirements

To qualify for the NRHP, ore treatment mills must meet at least one of the Criteria listed below and possess enough physical integrity to convey Property Type and significance.

Criterion A: Resources eligible under Criterion A must be associated with at least one Area of Significance noted above, as well as events and trends important to their immediate area or community.

Criterion B: Mills may be eligible under Criterion B when directly associated with the life of an important person significant in our past. Presence will most likely be through employment, management, or other involvement with the operation. The site must retain physical integrity relative to the person's productive life. A brief biography is necessary to detail the individual's significant contributions. Important people often invested in mills or directed companies, but did not occupy the property. Such an association does not meet registration requirements for Criterion B. The individual of note must have been present on-site. Applying Criterion B is complex, and *National Register Bulletin 32: Guidelines for Evaluating and Documenting Properties Associated with Significant Persons* can provide further guidance.

Criterion C: Sites may be eligible under Criterion C if they clearly reflect a type of ore treatment mill. Because most equipment, structures, and buildings were removed when a mill was abandoned, integrity is usually on an archaeological level. Distinguishing characteristics vary for the different mill types. In the case of an arrastra, its circular stone floor must be present and in its place of use. Archaeological features representing the sidewalls, capstan, mechanized power source, or support facilities are important contributing elements. At concentration and

amalgamation stamp mill sites, the building footprint, terraces and foundations, aspects of infrastructure, and support facilities should be represented by features and artifacts. The general ore treatment process should be identifiable, but its specifics can be approximated. Intact buildings, structures, or equipment are rare and possibly important. Mill sites with high integrity on an archaeological level are also rare.

Mill sites are potentially eligible under Criterion C when they are contributing elements of historic mining landscapes. Even when a mill is not completely intact in itself, a site may contribute to the setting and feeling of an area. Preserved terraces, foundations, and platforms are critical contributing elements. Some sites may be extensive enough to constitute localized landscapes in themselves.

Criterion D: Mill sites may be eligible under Criterion D if they hold a high likelihood of yielding important information upon further study. Arrastras have a high potential because few have been documented in the Rocky Mountain states, and little is currently understood about how miners actually constructed and operated the facilities. The surface features and artifacts may enhance the current knowledge, and even when only the floor is visible, arrastras can possess buried archaeological deposits and features that may contribute important details.

Concentration and amalgamation stamp mill sites can contribute in three general ways. The first is buried archaeological deposits such as privy pits, thick boiler clinker dumps, and refuse layers in tailings dumps. The deposits may include artifacts capable of enhancing our current understanding of workplace behavior and environment. If the workers lived on-site, residential deposits may illuminate the currently dim portrait of mill workers and their lifestyle. Second is a good assemblage of structures, foundations, or machinery. Detailed examination may reveal how metallurgists designed concentration processes for Clear Creek or Ten Mile Canyon ore and chose machinery accordingly. The third is a well-represented infrastructure. Documentation may demonstrate how engineers designed water, power, ore input, and tailings disposal systems.

Eligible mills must possess physical integrity relative to one of the Periods of Significance outlined above. Because most small mills possessed few structures and little machinery, usually salvaged when a site was abandoned, integrity will probably be on an archaeological level. Archaeological remains retain sufficient integrity when they permit the virtual reconstruction of the mill, its timeframe, and convey the site's significance.

Most of the seven aspects of historic integrity defined by the NRHP apply to mills. Some sites may possess buildings, structures, or machinery, which must retain *location* to contribute to a resource's integrity. For *location*, the structure or machine should have been present during the mill's operating time period. For a resource to retain the aspect of *design*, the resource's material remains, including the archaeological features, must convey the mill's organization, planning, and engineering. In many cases, mills were worked periodically and the treatment flow path adapted to new machinery or processes, leaving evidence of sequential modifications. In such cases, a resource can retain the aspect of *design* if the material remains reflect evolution over time. To retain the aspect of *setting*, the area around the mill, and the resource itself, must appear similar today as when it operated. If the resource is isolated, then the natural landscape should be preserved. If the resource lies in a mining landscape, then the surrounding mines and industrial features should retain integrity at least on an archaeological level. In terms of *feeling*, the resource should convey the sense or perception of milling from a historical perspective and from today's standpoint. Integrity of *association* exists in cases where structures, machinery, and other

features convey a strong connection between a mill and a contemporary observer's ability to discern the historic activity that occurred at the location.

PROPERTY TYPE: SMELTER

Smelters were among the most important facilities in the mining industry. They were final recipients for crude ore from mines and concentrates from mills, converting the material into metals. Smelting in the I-70 corridor was limited in timeframe and geographic extent. Metallurgists built a number of small plants in western Clear Creek drainage between 1865 and 1870, most failing but a few successfully treating ore until around 1875 (see Illustration B 1.15). Several smelters also operated at Idaho Springs during the mid-1880s. Mining around Dillon and Frisco was not productive enough to support a dedicated smelter. Although Clear Creek drainage smelters were not completely successful, they were important in several ways. The few effective plants produced the region's first silver, drew investment, and inspired confidence among capitalists. The failed plants were stepping stones in effective smelter design because they exemplified what not to do. Overall, silver mining would have remained static, if not failed altogether, without successful plants and the failures.

Clear Creek smelters used a combination of mechanical, chemical, roasting, and smelting processes to convert ores and concentrates into metals. See Section A 1.4 for more detail. Most of the facilities required flat space, a source of abundant water, and well-graded roads, and tended to be limited in scale and variety of components. The smelters usually featured several large buildings, high-volume coal and coke bins, and characteristic furnaces. Companies usually planned smelter complexes according to a master surface datum, and as a result, the various components shared a common orientation. Slag, the waste produced by smelting ore, almost always lies around a smelter site, appearing as fine-grained or glassy cobbles dark gray to black in hue.

Few if any smelters are presently intact in the I-70 corridor, with most sites impacted by deterioration, development, or other land use. As a result, most identifiable sites will possess physical integrity on an archaeological level at best. Commonly, stairstep terraces or platforms represent the building and general stages of ore preparation and smelting. Unfired crude ore, bin foundations, and a foundation for a jaw crusher should be evident on the highest terrace. The lowest terrace will offer evidence of the furnaces and blowers. Masonry foundations, brick rubble, and slag flows mark the locations of the furnaces, and machine foundations might remain from the blowers. Features reflecting screening and concentration machinery may lie on intermediate terraces. Smelters almost always had assay shops, and a shop platform should be present on or near the lowest terrace. Aspects of water and power systems are likely, as well. High volumes of slag and clinker from furnace fuel are telltale characteristics of smelter sites.

Smelter Significance

Smelters were crucial for silver mining in western Clear Creek drainage, helping the industry become Colorado's first significant silver producer. They also were a proving ground where metallurgists tested smelting processes on Colorado's resilient ore, made progress, and applied the experience in successful plants elsewhere. Smelters also supported gold mining in the eastern drainage by providing a local means for treating complex ore. The trends and historical

patterns relevant to smelters are summarized the NRHP Areas of Significance: Community Planning and Development, Economics, Engineering, and Industry.

Period of Significance must be considered when assessing the historical importance of smelters. Although the Period 1859 to 1942 covers mining as a viable industry throughout the I-70 corridor, smelting was limited to Clear Creek drainage, and only during two time periods. The first was in the western drainage from 1865 until 1875, and the second was in eastern Clear Creek drainage from 1885 through 1895.

Area of Significance: Community Planning and Development: Smelters participated in *Community Planning and Development* through a presence in the communities of Bakerville, Georgetown, Empire, and Silver Plume. Company organizers sited their plants in these communities to be near a workforce, shipping points, water, and commerce. The smelters, operating between 1865 and 1875, were important because they anchored growth patterns when the communities were young, being developed, and in flux. Further, the smelters attracted other mills and freighting services, which established the communities as local ore treatment centers. In the eastern drainage, smelters reinforced existing community development patterns at Idaho Springs.

Area of Significance: Economics: Smelters were significant in the Area of *Economics* for bringing wealth from two general sources. In one, facilities in the western drainage converted silver ore into an unrefined blend of silver and industrial metals known as silver matte. In the eastern drainage, the smelters produced gold matte. Cast as bricks, the matte became a cash product shipped to the Midwest in exchange for income. The second source was capital provided by investors to build and run the smelters. The operators then diverted much of the money into local economies as wages for workers, contractors' fees, and acquisition goods and supplies. In so doing, smelting companies supported the development of local economies and commercial systems.

Area of Significance: Engineering: Smelter operators employed engineering in designing individual structures, systems, or entire smelter complexes. Engineering was primitive and vernacular at the smelters in western Clear Creek drainage between 1865 and 1875. Vernacular engineering refers to structures and systems built by individuals who were not formally trained in metallurgy, mechanics, or furnaces. The individuals adapted familiar smelter designs and construction principals primarily from lead districts in Missouri, Wisconsin, and Minnesota. Frontier conditions such as available materials and equipment, and the natural environment were influencing factors in their designs. Although the smelters were highly inefficient and sometimes failures, they were important steps in understanding how to recover silver from ore in the western drainage. Resolution to problems posed by the ore allowed mining to then boom.

At the smelters around Idaho Springs, trained engineers and metallurgists adapted standard smelting principals to the character of the ore, expected tonnage, and available equipment and materials. Their guided interpretations were expressed as smelter design, treatment flow path, small-scale structures, and, ultimately, success. Working capital, environmental conditions, and then-current processes heavily influenced how metallurgists built their smelters. When a smelter was planned well, it enabled mining companies to produce higher tonnages of lower grade ore from deeper workings than was otherwise possible. In so doing,

successful smelter engineering prolonged the lives of many mines, which contributed to eastern Clear Creek drainage.

On a broader level, the period adaptations in smelter design and interpretations of ore treatment were critical steps in the ultimate success of silver smelting, and hence silver mining, in Colorado. Beginning in 1865, the western drainage was the first region in Colorado to yield silver ore in meaningful tonnages. The ore was complex, however, defying conventional metallurgical practices and methods effective for metals in other regions. In response, both trained metallurgists and inexperienced smelter operators imitated known smelter designs with limited success. Although metallurgists adapted the designs, most of the period smelters failed and only a few were successful. But both the failures and successes were important steps that other metallurgists subsequently built on. Based on lessons learned in the western drainage, metallurgists ultimately developed truly effective smelters for complex ore. The effective designs in turn allowed silver mining to thrive and become one of Colorado's principal industries.

Area of Significance: Industry: Smelters were important to *Industry* in Clear Creek drainage by fostering mining. When silver mining began in 1865, the industry was precarious because no ore treatment facilities existed, and smelters were necessary for profitable ore production. Metallurgists and inexperienced investors quickly responded by building smelters to fill the unmet demand. Although most of the smelters were small and inefficient at best, they were critical in several ways. First, some produced silver matte, demonstrating that the ore could, in fact, be effectively treated. This encouraged mining claim development, ore production, and further efforts to improve smelter designs. Second, the smelters legitimized silver mining and drew needed investment and expertise. The silver industry was then able to gain a foothold in the region and become a major employer, foundation of commerce and communities, and magnet for railroads and other development. By the time smelters were built in Idaho Springs, mining was already one of the most important forces shaping history in the central mountains. The smelters there reinforced this pattern.

Smelter Registration Requirements

To qualify for the NRHP, smelter sites must meet at least one of the Criteria listed below and possess sufficient physical integrity to represent the Property Type and convey significance.

Criterion A: Smelter sites eligible under Criterion A must be associated with at least one Area of Significance noted above, as well as important events and trends.

Criterion B: Smelter sites may be eligible under Criterion B when directly associated with the life of an important person significant to our past. Participation will likely be through employment, management or metallurgist, or builder. The site must retain physical integrity relative to the person's productive life. A brief biography is necessary to detail the individual's significant contributions. Important people commonly invested in smelters or directed companies but did not occupy the property. Such an association does not meet registration requirements for Criterion B. The individual of note must have been present on-site. Applying Criterion B is complex, and *National Register Bulletin 32: Guidelines for Evaluating and Documenting Properties Associated with Significant Persons* can provide further guidance.

Criterion C: Smelter sites may be eligible under Criterion C if they clearly represent a smelter. Because few if any smelters remain intact, integrity will be on an archaeological level. Distinguishing characteristics must be present, and may vary for early silver and later gold smelters. With early smelters, remnants of the masonry hearth or furnace should be discernible. At later smelters, the base for freestanding furnaces should be identifiable. In general, the smelter footprint, terraces, aspects of infrastructure, and support facilities should be represented by features and artifacts. The general flow path for the ore from input to furnace should be traceable, but the process specifics can be approximated. Intact structures and equipment, a high degree of integrity, or character-defining engineering or architectural features are rare, strengthening a site's potential eligibility. Important engineering and architectural features include intact buildings, structures, and machinery.

Smelter sites are potentially eligible under Criterion C when they are contributing elements of historic mining landscapes. Even when a smelter site is not completely intact in itself, the site may contribute to the setting and feeling of an area. Preserved terraces, foundations, and slag dumps are critical contributing elements.

Criterion D: Smelter sites may be eligible under Criterion D if they hold a high likelihood of yielding important information upon further study. The sites can contribute in three general ways. The first is buried archaeological deposits such as privy pits, thick boiler clinker dumps, and refuse layers in tailings dumps. The deposits may include artifacts capable of enhancing our current understanding of smelter operations, or workplace behavior and environment. Second is a good assemblage of structures, foundations, or machinery for the ore treatment process. Detailed examination may reveal how metallurgists designed smelters for complex silver and gold ore and chose machinery and furnaces accordingly. The third is a well-represented infrastructure. Documentation may demonstrate how engineers designed water, power, ore input, and slag disposal systems.

Eligible smelters must possess physical integrity relative to one of the Periods of Significance outlined above. Because few if any smelters are presently intact in the I-70 corridor, integrity will be on an archaeological level. Archaeological remains retain sufficient integrity when they permit the virtual reconstruction of the smelter, its timeframe, and convey the site's significance. Most of the seven aspects of historic integrity defined by the NRHP apply to smelters. Some sites may possess standing structures and objects, which must retain the aspect of *location* to contribute to a resource's integrity. For *location*, the structure or object should have been present during the operating time period. For a resource to retain *design*, the resource's material remains, including the archaeological features, must convey the smelter's organization, planning, and engineering. In many cases, smelters were converted to ore treatment mills with different machinery and treatment flow path. In such cases, a site can retain the aspect of *design* if the material remains clearly reflect evolution over time. To retain integrity of *setting*, the area around the smelter, and the site itself, must appear similar today as when it was developed. If the resource is isolated, then the natural landscape should be preserved. If the resource lies in a mining landscape, then the surrounding mines and industrial features should retain integrity at least on an archaeological level. In terms of *feeling*, the resource should convey the perception of smelting from a historical perspective and from today's standpoint. Integrity of *association* exists

where structures, machinery, and other features convey a connection between a smelter site and a contemporary observer's ability to discern the historic activity at the location.

MINING SETTLEMENT AND RESIDENCE PROPERTY TYPES

Between 1859 and around 1920, prospectors, miners, and industry participants examined nearly every, if not all, the canyons, gulches, hills, and mountains in the I-70 corridor. In those locations where mining industry participants spent appreciable amounts of time, they usually established residences. Every mining district featured at least isolated prospectors' camps and collections of residences, and where mines and prospects were numerous and closely spaced, residential concentrations referred to as settlements. Many settlements such as Wheeler in Ten Mile Canyon or Silver Creek in Clear Creek drainage never progressed beyond an informal status, but when a local mining industry showed signs of permanency and the population grew large enough, some settlements matured into formally organized towns.

As places of inhabitation, the residences common to the mining industry fall into several broad categories. In ascending order of complexity and population, related Property Types are prospector's camp, workers' housing, unincorporated settlement, and townsite. Their descriptions and registration requirements are provided below. But where the descriptions are identical to Property Types described in *The Mining Industry in Colorado* and *Historic Mining Resources of San Juan County, Colorado*, the reader is referred to those Multiple Property Documentation Forms.

PROPERTY TYPE: PROSPECTOR'S CAMP

See *The Mining Industry in Colorado* and *Historic Mining Resources of San Juan County, Colorado*. See Illustration B 1.16 for an example.

Prospector's Camp Significance

Historical trends and patterns specific to prospecting and associated camps are summarized below as NRHP Areas of Significance: Exploration/Settlement, Industry, and Politics/Government.

In general, the Period of Significance 1859 to 1942 covers mining as a viable industry throughout the I-70 corridor. Narrower timeframes are, however, more applicable to prospecting in those regions where mining occurred. Clear Creek drainage and the Dillon and Frisco area in particular followed their own chronologies of mineral discovery and development. Further, in Clear Creek drainage, Periods of Significance differed for gold and silver. Prospecting for gold was important throughout the entire drainage from 1859 through 1864. The search for gold then contracted to the eastern portion, from Floyd Hill west to Empire, between 1865 and 1910. Silver prospecting was important in the western drainage, from Empire west to Loveland Pass, between 1864 and 1893. Although some prospecting occurred afterward, it contributed little to the mining industry because the principal ore formations had already been found and developed. Prospecting was significant in the area around Dillon and Frisco between 1878 and 1885, and again from 1897 until 1905. Level of significance was local.

Area of Significance: Exploration/Settlement: Prospectors' camps participated in *Exploration/Settlement* as bases of operation and residence on the central Rocky Mountain mining frontier. Individual prospectors and prospect outfits were on the forefront of the frontier, laying groundwork for the establishment of regional mining industries. Working from their camps, prospectors were usually the first to conduct extensive physical and mineralogical exploration, relaying information critical to subsequent mining interests and settlers. Prospectors and prospect outfits were among the first Euro-Americans to inhabit the I-70 corridor, especially when a rush developed, bringing political, economic, and social systems. Localized mining industries and settlement patterns then quickly followed. The overall movement resulted in the exploration, settlement, and industrialization of the central Rocky Mountains.

Area of Significance: Industry: The initial growth and development of the mining industry was a movement that began with prospecting. With support from their camps, prospectors located and then began developing hardrock veins. Within a short time, outside investors organized companies to purchase and improve the primitive operations. Although most failed, some became profitable and in turn inspired confidence among other investors, who felt encouraged to do likewise. Their capital combined with additional prospectors, other people, and regional development, became a mining industry. Cumulatively, individuals and the companies, regardless of size, improved transportation networks, reinforced extant settlement patterns, contributed to local economies, and established commercial and communications systems.

Area of Significance: Politics/Government: The Area of Significance applies to prospectors' camps in Clear Creek drainage dating from 1859 through 1864. The prospectors who lived in the camps participated in organizing the region's earliest mining districts, which codified laws, governing bodies, and documentation. The frontier legal system defined hardrock claim types, rights, and sizes as well as crime and punishment. The Territorial Legislature then included many of the definitions and rights in its 1861 charter.

Prospector's Camp Registration Requirements

National Register-eligible prospector's camps must meet at least one NRHP Criterion below and possess sufficient physical integrity to represent the Property Type and convey significance.

Criterion A: Camps eligible under Criterion A must be associated with at least one Area of Significance noted above, as well as events and trends important in their host segment of the I-70 corridor.

Criterion B: Camps may be eligible under Criterion B when directly associated with the life of an important person significant to our past. The individual must have lived in the camp, and the site must retain physical integrity relative to the person's productive life. A brief biography is necessary to detail the individual's significant contributions. In some cases, important people invested in prospect operations or owned claims but did not occupy the camp. Such an association does not meet Criterion B registration requirements. The individual of note must have been present on-site. Applying Criterion B is complex, and *National Register Bulletin 32:*

Guidelines for Evaluating and Documenting Properties Associated with Significant Persons can provide further guidance.

Criterion C: Prospectors' camps can be eligible under Criterion C when their features and artifacts clearly represent the Property Type and convey its significance. Because tents, buildings, and items of value were usually removed or collapsed, integrity is expected to be on an archaeological level. Character-defining features include a tent or cabin platform, refuse scatter, and possibly a corral or blacksmith forge. Such camps represent the typical residences associated with mineral examinations and discoveries, the beginnings of mineral booms, and the general exploration of the region. Intact buildings and structures necessary for prospecting, such as cabins and field forges, are rare and possibly significant. Clearly definable camps with integrity are uncommon, as well.

Criterion D: Prospectors' camps may be eligible under Criterion D if they are likely to yield important information upon further study. In cases where camp sites possess building platforms, privy pits, and refuse dumps with buried archaeological deposits, testing and excavation may reveal information regarding the lifestyles, social structures, and demography of prospectors. Such studies are important because these subjects were not extensively documented at the time. In general, however, few resources are likely to be eligible as occupation was brief and archaeological deposits are unlikely.

Prospectors' camps must retain physical integrity relative to one of the Periods of Significance mentioned above. Because buildings and structures either decayed or were removed after the camp was abandoned, integrity will probably be on an archaeological level. To be eligible, the archaeological features and artifacts must clearly reflect the camp, its timeframe, and content.

The most applicable NRHP aspects of historic integrity will be *location*, *design*, *setting*, *feeling*, and *association*. Intact buildings and structures must be in their original places of use to retain integrity of *location*. A resource retains integrity of *design* when the overall feature assemblage reflects the camp's layout and relationship to the environment. Integrity of *setting* requires the terrain around the camp, and the resource itself, to appear similar today as when it was developed. If the camp was isolated, then the natural environment should be preserved. If the resource is in a mining landscape, then nearby mines and other resources should retain integrity at least on an archaeological level. In terms of *feeling*, the resource should convey the sense or perception of mineral exploration, both from a historical perspective and from today's standpoint. Integrity of *association* exists where prospect workings, structures, and other visible features convey a connection between the property and a contemporary observer's ability to discern the historic operation.

PROPERTY TYPE: WORKERS' HOUSING

See *The Mining Industry in Colorado* and *Historic Mining Resources of San Juan County, Colorado*. See Illustration B 1.17 for a boardinghouse example.

Workers' Housing Significance

The principal historical trends and patterns relevant to Workers' Housing are summarized below as NRHP Areas of Significance: Architecture, Community Planning and Development, Exploration/Settlement, and Industry.

The Period of Significance 1859 through 1942 covers mining throughout the I-70 corridor, but narrower timeframes of importance are more applicable by region. The industry in the Dillon and Frisco area was distinct from Clear Creek drainage, each following its own chronology. Mining was important throughout Clear Creek drainage from 1859 through 1864. Gold production declined for a time, replaced by silver in the western drainage from Empire west to Loveland Pass. Silver mining was significant from 1865 through 1920. Gold production resumed in the eastern drainage, from Floyd Hill west to Empire, in 1873. Gold mining then became important through 1918. The industry was largely quiet and unimportant during the 1920s but returned to significance from 1930 through 1942. Hardrock mining significant in the area around Dillon and Frisco during three time periods: 1878 through 1885, 1890 into 1893, and 1898 until 1920.

Area of Significance: Architecture: The Area of *Architecture* applies to intact Workers' Housing buildings, and specifically cabins, houses, and boardinghouses. Historically, small houses and cabins represent the simple and austere architecture typical of wage workers in mountain mining communities. Boardinghouses tend to reflect company housing, and sometimes independent lodging businesses, for single miners. In constructing the above residence types, workers and companies adapted familiar building designs and construction methods to Rocky Mountain mining conditions. Influencing factors included local climate, community, and natural and industrial landscape features. In many cases, economic constraints, traditions in construction, interpreted needs, and available building materials also influenced adaptation of designs and methods. As a result, workers and companies contributed to existing patterns of functional and yet cost-effective mining industry architecture.

Area of Significance: Community Planning and Development: The Area of *Community Planning and Development* is relevant to workers' housing located in corridor settlements. Construction of workers' housing directly supported the growth of organized communities, and its on-going occupation contributed to their fabric and stability. Workers' housing drew residents who became active participants in a community's population, which increased with construction of more housing. Many of the residents were laborers with families, who tended to support local economy, community events and institutions, and government. Housing, a manifestation of worker residence, became an important physical element of the communities.

Some unincorporated settlements were exclusively workers' housing, offering few if any businesses. These communities grew organically in response to local employment, miners inhabiting cabins, houses, and boardinghouses to be near their points of work. Silver Creek in

Clear Creek drainage is one example. Workers' housing was the basis for these types of settlements.

Area of Significance: Exploration/Settlement: Workers' housing is important in *Exploration/Settlement* through its direct association with the mining industry. Relevant timeframe is 1859 through 1880 in Clear Creek drainage, and 1878 through 1885 in the Dillon and Frisco area. During these periods, workers' housing was a physical anchor for the frontier in the central Rocky Mountains. With the support of housing, miners penetrated most of the region, quantified its general geography, and outlined the economic geology. Through claim examination, sampling, and development, they prepared the region for investors and companies. Localized mining industries and associated settlement patterns quickly followed. The overall movement resulted in exploration, settlement, and industrialization of the central Rocky Mountains.

Workers' housing was a form of mining frontier settlement in itself. Concentrations of cabins and boardinghouses erected near groups of mines evolved into unincorporated settlements, which in turn evolved into towns. Additionally, the numerous cabins and boardinghouses at isolated mines scattered throughout the mountains were a disbursed settlement pattern characteristic of the frontier.

Area of Significance: Industry: Workers' housing was important in the Area of *Industry* as an essential component of the mining industry. During the earliest years in Clear Creek drainage and the Dillon and Frisco area, mining companies were on the forefront of the frontier, bringing social, economic, governmental, and transportation systems. As the industry grew, it became one of the most important forces shaping history in the central mountains. The industry was the largest employer, supported most of the communities, fostered commerce, attracted railroads, and influenced politics and government. By producing an enormous amount of gold, silver, and industrial metals, the industry supported the regional economy and contributed on a statewide level. The industry also was the foundation of Euro-American settlement, outliving the industry itself. The industry was a function of its workers, who required housing.

Workers' Housing Registration Requirements

To qualify for the NRHP, a workers' housing building or complex must meet at least one of the Criteria listed below, and possess sufficient physical integrity to convey the Property Type and its significance.

Criterion A: Resources eligible under Criterion A must be associated with at least one Area of Significance noted above, as well as events and trends important in the mining industry, or host area of the I-70 corridor.

Criterion B: Workers' Housing may be eligible under Criterion B when directly associated with the life of an important person significant in our past. The resource must retain physical integrity relative to that person's productive life. Association with the resource is expected to be through residence. The researcher must detail the person's significant contributions in a brief biography. In some cases, important people owned housing or invested in associated companies but did not occupy the property. Such an association does not meet registration requirements for Criterion B.

The individual of note must have been present on-site. Applying Criterion B is complex, and *National Register Bulletin 32: Guidelines for Evaluating and Documenting Properties Associated with Significant Persons* can provide further guidance.

Criterion C: Workers' housing can be eligible under Criterion C under certain conditions. Here, it is best to distinguish between resources with standing buildings from those manifesting as archaeological sites.

Presently, workers' residences in the forms of cabins, houses, and boardinghouses stand intact in Clear Creek drainage and in the Dillon and Frisco area. Small and simple houses and cabins represent the simple and austere architecture typical of wage workers. The researcher must define the building type, timeframe, architectural style, and why the building is an important example. Boardinghouses are uncommon and may reflect an adaptation of residential architecture to the needs of both the mining industry and its workforce. It should be noted that relatively few residential buildings will retain integrity relative to a single timeframe due to alterations over time.

Some residential buildings may be representative examples of works by important architects and builders. The researcher must identify who the individual was and provide biographical information explaining why they were important.

If the residence possesses innovative architectural aspects and retains integrity relative to a Period of Significance noted above, it may be eligible as an example of its type. Innovative aspects include adaptations in architecture to environmental, climatologic, and geographic environments. Adaptations may manifest as design, function, construction methods, or materials.

Many residential buildings are located in existing historic mining communities. A residence may be a contributing element if it is compatible in timeframe and appearance, contributing to the community's historic feeling and association.

Outside of existing communities, most workers' housing complexes have collapsed or have been removed, leaving archaeological features including building ruins, building platforms, and privy pits. When on an archaeological level, complexes can be eligible if they offer character-defining features and possess integrity relative to a Period of Significance. Integrity on an archaeological level requires intact artifact and feature assemblages clearly conveying the organization and infrastructure of the housing, and aspects of the residents and their lifestyles. Design of the complex is an important attribute, whether planned in advance or a spontaneous response to local conditions. Evidence of how the residents inhabited the complex, conducted domestic activities, and added support facilities are additional character-defining attributes. Intact artifact assemblages are important because they reflect resident demography and lifestyle.

Criterion D: Workers' housing may be eligible under Criterion D if it has a likelihood of yielding important information upon further study. An analysis of a complex and its architectural features may enhance the existing understanding of workers' housing and the residential environment associated with the mining industry. Workers' housing complexes often possess a diverse array of artifacts found on ground-surface. Building platforms, privy pits, and refuse dumps feature buried archaeological deposits with artifacts often different in nature. Analysis of both may reveal information regarding the lifestyles, social structures, and demography of workers, as well as the presence of families and women. Such studies are important because these subjects were not extensively documented at the time.

Resources that can be confirmed as Workers' Housing and possess physical integrity relative to one of the Periods of Significance are significant. Intact buildings retain integrity when the period, appearance, design, and form are clearly evident. Archaeological sites retain integrity when material evidence conveys building locations, design of the complex, and aspects of the residents and their lifestyles.

Most of the seven aspects of historic integrity defined by the NRHP apply to workers' housing. A building retains integrity of *location* when standing in a place of use as workers' housing. To retain *design*, the resource must convey organization and planning applied to workers' housing. Standing buildings should embody their original plan, form, and appearance. If the building was subsequently altered or expanded with additions, it can retain *design* if the material remains reflect sequential evolution. Archaeological complexes retain *design* when features and artifacts convey locations of buildings and facilities, and land use patterns. In integrity of *materials* and *workmanship*, the extant materials and workmanship should be those used during the timeframe. To retain *setting*, the area around the resource, and the resource itself, must not have changed a great degree from its timeframe. If the resource lies in a mining landscape, the surrounding mines and industrial features should retain integrity at least on an archaeological level. If a resource stands in a built environment, surrounding architecture should be compatible in appearance and timeframe. In terms of *feeling*, the resource should convey a sense of historic residence. Integrity of *association* exists where a physical elements convey a strong connection between the resource and a contemporary observer's ability to discern its function as workers' housing.

PROPERTY TYPE: ISOLATED RESIDENCE

See *The Mining Industry in Colorado* and *Historic Mining Resources of San Juan County, Colorado*.

Isolated Residence Significance and Registration Requirements

By definition, isolated residences cannot be directly attributed to an industry without substantial research. Their historic associations and significance are therefore indefinite. The presence of buried archaeological deposits or features, however, may yield information related to what industry residents were associated with. In this case, a resource may be eligible under Criterion D.

PROPERTY TYPE: MINING SETTLEMENT

Property Subtype: Unincorporated Settlement: See *The Mining Industry in Colorado* and *Historic Mining Resources of San Juan County, Colorado*. See Illustration B 1.18 for an example.

Property Subtype: Townsite: Of all the resource types in the I-70 corridor, townsites range the most in complexity, period of occupation, integrity, and authenticity. Some small towns changed little after their boom period, while others have been moved or experienced continued construction to present time. Applying registration requirements is thus more complicated than the other types of mining resources. Although Section B 8 in this document establishes basic guidelines for addressing architecture, large towns such as Georgetown and Frisco, with their numerous buildings and extant populations, require additional context beyond that generalized to the mining industry. Small and simple townsites, however, may be recorded and evaluated as individual entities or districts. Below are broadly applicable registration requirements.

When a mineral boom matured from a prospecting phase toward development and production, the new industry often drew a working population demanding goods and services. The shift ushered in a stage of growth, and a common result was an evolution of unincorporated settlements into organized towns. In many cases, the towns remained small and were abandoned within a short time, but if the industry was successful, some became large and sophisticated.

Small or large, both forms of community shared some basic physical characteristics and organization patterns (see Illustration B 1.19). An identifiable business district was the most elementary, offering goods and services proportional in volume and diversity to the population. Towns in early stages of growth usually featured a few mercantiles, saloons, restaurants, and hotels, as well as a butcher, bakery, assayer, laundry, livery, and blacksmith. As the population increased in number and sophistication, entrepreneurs began additional businesses such as newspapers, law practices, surveying, confectioneries, clothing retailers, stationary and book stores, medical and dental, and hygiene. Gaming houses were ubiquitous, and towns large enough to afford some social anonymity also drew prostitution. Although not heavily documented, women and families were an essential demographic of mining towns, reflecting a stable, working population. They demanded social institutions such as schools, churches, fraternal organizations, and public meeting halls.

Business districts, however small, served as town centers surrounded by professionally designed residences usually occupied by members of an upper socioeconomic status. In many towns, business proprietors lived in their commercial buildings in separate quarters. The town core conformed to a surveyed grid of lots and blocks, while outlying residences may have been scattered. These were usually inhabited by workers and members of a lower socioeconomic status. Workers also rented space in boardinghouses or took a room in a family home. As the town grew and population diversified, both the business and residential districts divided further among socioeconomic or ethnic lines.

Town architecture was a function of community development, success of the mining industry, timeframe, distance from shipping and manufacturing centers, and available materials. In a town's early period, the architecture tended to be vernacular in appearance and form. Builders preferred milled lumber and manufactured elements, but made extensive use of local materials when these were costly or unavailable. Logs were the most common local materials for walls and roof beams, with stone for foundations.

The earliest buildings in a town were wall tents and log cabins. Within several years, residents assembled their buildings from combinations of lumber, logs, canvas, and sheet iron. Frame architecture was preferred, but expensive until the town had a sawmill or a wagon road to commercial centers. In form, most buildings were simple with gabled roofs, and one or two stories. Commercial buildings may have featured false fronts and plank walks or stoops. Buildings usually stood on informal foundations, had roofs sided with shingles or log strips, and

featured walls clad with boards-and-batten, plank, or clapboard. Wealthier individuals at times added some ornamentation to their buildings, such as trim to display status or in imitation of architecture in established cities.

Architectural improvements were hallmarks of community maturation and economic stability. An increase in building lot values, the perceived obsolescence of logs, and social preference for frame buildings contributed to gradual architectural improvement. New buildings tended to be more substantial, exhibiting standardized construction materials and practices. Elements of architectural style began appearing as early as the 1860s in Clear Creek drainage and the 1880s in Dillon and Frisco. Ornamentation suggested Greek Revival, Italianate, and Queen Anne styles, as well as pattern books. Even though some business owners did not attempt a specific architectural style, they still decorated their buildings with lathed columns, molding, ornamental brick- or woodwork, and polychromatic effects. Vernacular form and appearance, however, continued to be universal. Although brick and stone replaced lumber for some of the important buildings in the largest towns, the smaller settlements saw little masonry construction. Residents did, however, use sheet iron stamped with imitation brick and stone patterns, suggesting masonry from a distance.

Most mining towns possessed infrastructures proportional in sophistication to the success of the mining industry, population, and expectation of permanency. On a base level, most infrastructure related to transportation, communication, and limited public utilities. Transportation infrastructure usually featured trunk roads that carried freight and passenger traffic to the town, and feeder roads extending to surrounding mines and mills. Streets and footpaths directed traffic within town, and even though many towns were arranged according to a grid, the roads and paths did not always conform. The ultimate transportation system was the railroad, serving Clear Creek drainage by 1877, and the Dillon and Frisco area by 1882.

Early in a town's development, communication systems were limited primarily to the postal service and newspapers. By the early 1880s, the principal towns enjoyed the telegraph, followed by telephone systems within a few years. By around 1900, many towns of lesser importance also subscribed to telephone service. Water systems were one form of public utility that saw application in both towns and workers' housing erected by mining companies. Water systems made an appearance in Georgetown and Silver Plume during the 1870s, and although some minor towns followed during the subsequent twenty years, many small communities never saw water systems. Introduction of flush toilets, bathtubs, and sinks during the 1890s fostered a demand for sewer systems in large towns. Most systems consisted of little more than pipes and culverts draining into local waterways. One of the most important forms of public utility was electricity, available in Clear Creek drainage during the 1890s and at Frisco and Dillon shortly after 1900. The ability to subscribe to domestic and commercial service was based on socioeconomic status, which excluded many residents until the 1940s.

Mining Settlement Significance

Unincorporated settlements and townsites are associated with similar Areas of Significance. They include Architecture, Commerce, Community Planning and Development, Economics, Engineering, Exploration/Settlement, Industry, Politics/Government, and Transportation. Character-defining features for settlements are listed at the section's end.

Area of Significance: Architecture: Regarding *Architecture*, settlements were places where both mining companies and independent residents adapted conventional design and construction methods to a region's physical environment and available materials. Most buildings were vernacular in form and construction, influenced by the builder's financial resources, interpretation of needs, skills and experience, and preferences. Townsites were later a vehicle for the introduction of defined architectural stylistic elements, methods of construction, and design to a region.

Area of Significance: Commerce: In the *Area of Commerce*, townsites and unincorporated settlements were centers of commerce, business, and trade. They were local nodes of exchange in goods, services, and local products vital for residents, business interests, and industry. Settlements also directly participated in complex regional economic and commercial systems, primarily through importation of agricultural produce and manufactured goods and export of natural resources.

Area of Significance: Community Planning and Development: Townsites, and to a lesser degree unincorporated settlements, introduced platting, community organization, infrastructure, municipal ordinances, and business development. Townsites and unincorporated settlements also influenced the distribution of population, social classes, gender, businesses, and some industrial facilities. The towns tended to draw specialty retail and service businesses, advanced transportation, power generation, and diversity in population. Unincorporated settlements were more industrial with mines, mills, basic businesses, drayage transportation, and populations dominated by workers.

Area of Significance: Economics: In terms of *Economics*, townsites and unincorporated settlements were centers of wealth, banking, and movement of money. They also served as anchors and conduits for capital and investment. The presence of established settlements, especially towns, lent legitimacy to a local mining industry, fostering confidence among potential investors. Settlements became points through which capital flowed from investors to the community and its mines and mills.

Area of Significance: Engineering: *Engineering* applies primarily to designed infrastructure systems. Towns and large unincorporated settlements were vehicles that brought basic civil engineering to the mountains. Georgetown, Idaho Springs, and Silver Plume received advanced water systems at first for fire safety, and later modified for domestic consumption. These and other settlements also were important nodes in electrical systems. In building the systems, engineers adapted familiar design and construction principals to the specific needs of communities. Available materials or equipment, capital, climate, and the environment influenced how the systems took form.

Area of Significance: Exploration/Settlement: The *Area of Exploration/Settlement* applies to settlements whose remains date between 1859 and 1880 in Clear Creek drainage, and 1878 through 1885 in the Dillon and Frisco area. During these periods, settlements were physical anchors for the frontier in the central Rocky Mountains. Miners and prospectors living in the settlements penetrated most of the region, quantifying its general geography and economic geology. The settlements became clearinghouses for the information, which guided investors and

companies. Localized mining industries and associated settlement patterns quickly followed. The overall movement resulted in the exploration, settlement, and industrialization of the central Rocky Mountains.

Area of Significance: Industry: Townsites and unincorporated settlements supported the mining industry by housing its workers, providing goods and services, and hosting mines and mills. Towns were also nodes infrastructure required for success of the industry, including milling, transportation, and communication. Due to the settlements, the industry became one of the most important forces shaping history in the central mountains. It was the largest employer, fostered commerce, drew railroads, and influenced politics and government. By producing an enormous amount of gold, silver, and industrial metals, the industry supported the regional economy and was the foundation of Euro-American settlement, which outlived the industry itself.

Area of Significance: Politics/Government: In the Area of *Politics/Government*, settlements were centers of law enforcement and judicial systems created in response to social and mining disputes and crime. Administrative and regulatory bodies developed in the principal towns to oversee local government activities, claim registration and regulation, and records keeping. Designation as county seat was height of this trend. Settlements also served as polling stations, and overall populations proved instrumental in the election of government officials.

Area of Significance: Transportation: Townsites and unincorporated settlements were key transportation nodes and transfer points for the movement of goods and people. The supplies, equipment, and services required for industry flowed into the settlements prior to their distribution to consumers, and ore and mill products flowed out. The transportation systems included several modes of conveyance and connections, ranging from rail service to wagons, and stages to pack trains.

Mining Settlement Registration Requirements

To qualify for the NRHP, a townsite or unincorporated settlement must meet at least one of the Criteria listed below, and possess sufficient physical integrity to convey Property Type and significance.

Criterion A: Settlements eligible under Criterion A should be associated with at least one Area of Significance noted above, as well as events and trends important in the corridor.

Criterion B: A settlement may be eligible under Criterion B when occupation by an important person or persons significant to our past can be confirmed. The individual's specific place of occupation must be identified, and in such cases, the place with the most direct association will qualify. The place must retain physical integrity relative to the individual's productive life. Ownership of property or investment in a townsite company are too indirect an association for Criterion B registration requirements. The individual must have been present on-site. The researcher should provide a brief biography detailing the individual's significance and association with the property. Applying Criterion B is complex, and *National Register Bulletin 32: Guidelines for Evaluating and Documenting Properties Associated with Significant Persons* can provide further guidance.

Criterion C: Settlements may be eligible under Criterion C under certain conditions. Although some townsites currently possess standing buildings, most will include archaeological features.

Townsites can be eligible in entirety if the archaeological, architectural, or engineering features and artifacts clearly convey broad patterns of the community. The townsite's organization and design is one example. Although most designs were based on grids, some townsites grew spontaneously in response to local conditions. Road intersections, railroads, and local topography greatly influenced a settlement's final form. The distribution of residences, businesses, and industrial facilities constitutes another broad pattern. The transportation infrastructure, water sources, and waste disposal practices, however primitive, are additional patterns of potential significance.

Integrity on an archaeological level requires intact assemblages of surface artifacts with the potential to yield important information. Artifacts are necessary to interpret timeframe and function of the townsite as well as its individual buildings. Boardinghouses, cabins inhabited by families, and different businesses left distinct types of artifacts. By analyzing the artifacts, the researcher may be able to determine the function of some buildings, even when represented by archaeological remnants. A researcher can interpret socioeconomic status, gender, ethnicity, and modes of employment among residents; characterizing aspects of lifestyle such as diet, health, and consumerism.

Standing buildings possessing integrity relative to a Period of Significance may be individually eligible or as contributing elements of a larger site. Settlements inhabited today often possess more recent construction. If the number of such buildings overtly disrupts the townsite's historic fabric, then the townsite as an entity may no longer possess necessary level of integrity. Even if a townsite lacks integrity as a whole, standing buildings may be individually eligible under Criterion C. If the building retains architectural integrity relative to its Period of Significance, it may represent a significant type common to that era. Buildings altered over time may be examples of serial occupation and changes in preferred materials, styles, and space requirements. Such buildings be eligible as adaptations in architecture to the environment, climate, and geography of its region. Buildings can be attributed to important architects and builders. If the building retains integrity relative to its original design, it may be eligible as the work of a master architect or builder, known or unidentified. Even when reduced to archaeological features, townsites may be eligible under Criterion C as historic mining landscapes.

Criterion D: Settlements may be eligible under Criterion D for their potential to yield meaningful information. Analysis of architectural features may augment present understanding of the commercial and residential environment, practices, and trends associated with the mining industry. Broad-scale studies of settlements often reveal aspects of community development, distribution of gender, modes of employment, socioeconomic status, and business practices. Settlements often possess building platforms, privy pits, and refuse dumps featuring buried archaeological deposits. Testing and excavation may reveal information regarding types of businesses, lifestyle, social structure, demography or residents, and trends involving women and families. Such information is significant because it was not well-documented at the time.

National Register-eligible townsites and unincorporated settlements must possess physical integrity relative to one of the Periods of Significance defined above. Because most

buildings either collapsed or were dismantled, integrity will probably be primarily on an archaeological level. Integrity is sufficient when material evidence conveys building locations and function, settlement design or patterning, and aspects of infrastructure. The artifact assemblage should also reflect aspects of the residents and their lifestyles. Overall, the site must embody the defining characteristics of a townsite or unincorporated settlement, and convey its historical significance.

Most of the seven aspects of historical integrity defined by the NRHP apply to settlements. Some may possess standing structures, which must retain the aspect of *location* to contribute to a resource's integrity. For a settlement to retain integrity of *design*, the material remains, including archaeological features, must convey community organization and planning. Individual buildings can retain integrity of design in two principal ways. Unaltered buildings can exhibit their original form, floorplan, and construction. Buildings altered through serial occupation retain integrity of *design* if they reflect evolution within the historic period. Integrity of *materials* and *workmanship* is retained when a building exhibits predominantly original materials and construction methods. To retain the aspect of *setting*, the area around the resource must not have changed a great degree from its Period of Significance, with allowance for removal of buildings and structures. If the settlement is separated from mining, then the natural landscape should be preserved. If the resource lies in a mining landscape, then the surrounding mines and industrial features should retain integrity at least on an archaeological level. In terms of *feeling*, the resource should convey the sense of historic community. Integrity of *association* exists where features convey a connection between a settlement and a contemporary observer's ability to discern historic occupation.

PROPERTY TYPE: RURAL HISTORIC MINING LANDSCAPE

Rural Historic Landscapes are a large-scale property type representing the history of an area's human occupation, life ways, and relationship with the land. The National Park Service recognizes other types of landscapes NRHP nomination, such as designed historic landscapes and cemeteries. The National Park Service describes Rural Historic Landscapes in detail in its *National Register Bulletin: Guidelines for Evaluating and Documenting Rural Historic Landscapes*. In overview, the Bulletin states:

A rural historic landscape is defined as a geographical area that historically has been used by people, or shaped or modified by human activity, occupancy, or intervention, and that possesses a significant concentration, linkage, or continuity of areas of land use, vegetation, buildings and structures, roads and waterways, and natural features.⁶⁷⁶

Areas subject to mining form a subset, Rural Historic Mining Landscapes. Such landscapes provide a physical context for individual resources, and when viewed in total, the resources in their setting constitute a greater whole. Extensive tracts of land, its natural features, and individual historic resources represent the history, people, and traditions of mining in the I-70 corridor.

⁶⁷⁶ McClelland, Linda Flint; Keller, J. Timothy; Keller, Genevieve P.; Melnick, Robert Z. *National Register Bulletin: Guidelines for Evaluating and Documenting Rural Historic Landscapes* National Park Service, 1999, 1.

The National Park Service organized the defining characteristics of Rural Historic Landscapes into eleven categories. The first four are the result of processes, and the last seven are physical attributes.⁶⁷⁷ The categories are: land uses and activities; patterns of spatial organization; response to the natural environment; cultural traditions; circulation networks; boundary demarcations; vegetation related to land use; buildings, structures, and objects; clusters; archaeological sites; and small-scale elements.

The defining characteristics of a rural historic mining landscape also can be described as a “landscape of work.”⁶⁷⁸ Mining outfits molded the landscape for the efficiency, organization, and economics of finding ore, extracting it, and processing the material. Mining landscapes of work include features characteristic of mining. Placer mines occupy drainage floors, hardrock prospects are concentrated in areas where ore was likely, and hardrock mines lie on land where ore formations were confirmed, regardless of topography. Ore treatment mills were sited either at mines or in drainages where water and open ground were available. Companies erected workers’ housing at mines and mills that were distant from established communities. Unincorporated settlements and planned towns grew in the most suitable environments near the centers of mining and milling. Circulation systems in the form of packtrails linked prospects with communities, and roads connected mines, mills, and transportation centers. Ditch systems diverted water from streams to reservoirs for industrial and community consumption. The forests around the mines and communities were cut over to provide wood for heating, steam power, and lumber. Sawmills were located close to mature stands to minimize hauling cut logs. All are variations on the working landscape as related to mining in the I-70 corridor.

Rural Historic Mining Landscape Significance

Because multiple historic resources and natural features make up rural historic mining landscapes, significance can be assessed in terms of the broad historic theme of mining, associated settlement, and infrastructure development. Potential NRHP Areas of Significance include Architecture, Community Planning and Development, Economics, Engineering, Industry, and Transportation. Because of complexity and diversity of constituent historic resources, coupled with on-going and evolving use, most landscapes may be significant under multiple NRHP Areas and Criteria. Extended Periods of Significance must be considered when determining the significance of rural historic mining landscapes. In general, the Period applicable to mining in the I-70 corridor spans 1859 to 1942.

Area of Significance: Architecture: Historic landscapes with standing buildings may be important in the Area of Architecture for several reasons. Mining industry participants adapted familiar building form, design, and construction methods to the central Rocky Mountains. In their adaptation, miners responded to topography, natural landscape features, local climate, and available building materials. When distributed amid a landscape, multiple buildings can represent the evolution of architecture specific to mining in the mountains.

Areas of Significance: Commerce and Economics: The Areas of *Economics and Commerce* shared a symbiotic relationship that can manifest in mining landscapes. Assemblages of

⁶⁷⁷ McClelland, et al., 1999:3.

⁶⁷⁸ Messick, Denise P.; Joseph, J.W.; Adams, Natalie P. *Tilling the Earth: Georgia's Historic Agricultural Heritage, A Context* Stone Mountain, GA, New South Associates, 2001, 62.

resources including mines, mills, roads, and railroads reflect the overall process of converting natural resources into wealth. The mines produced ore carried over roads to mills. The ore was processed at the mills, gold and silver were recovered, and the concentrates shipped by road or rail to a smelter for final processing. Each stage furthered the ore-to-wealth cycle. Each stage also represents a divestment of money through the region as workers' wages, fees for services, and consumption of goods. Communities in the landscape were local economic centers where the divested funds supported commerce. The capital used to organize, equip, and support mining companies in turn shaped the land through the ore-to-wealth cycle.

Areas of Significance: Community Planning and Development: Landscapes can be important in the Area of *Community Planning and Development* if they reveal settlement patterns characteristic of mining. Unlike traditional settlement patterns, mining industry participants established residential complexes near centers of mining or related industry regardless of environmental conditions. Proximity to mines and industry was a first priority, and the best microenvironment for a residence or community was secondary. Landscapes can reflect development patterns characteristic of mining itself, and the influence of natural resources on settlement. It should be noted that settlement is not limited to concentrations of residences, such as towns. The workers' housing and prospectors' camps scattered throughout the mountains are an alternate settlement pattern.

Area of Significance: Engineering: Historic landscapes can represent widespread adaptation of engineering practices to mining in the central Rocky Mountains. Small-scale resources may be significant representations of mining engineering, and multiple structures within a single landscape may reflect the evolution of function, design, construction methods, workmanship, and materials. With small-scale resources, mining companies may have adapted familiar types of structures and machinery to the mountain environment. Mining operations may have also innovated new ways of solving problems posed by the land and its natural resources. Conditions included natural landscape features, local climate, and available capital and buildings materials. Complex systems such as water infrastructure for placer mining may be expressed across an entire landscape. On a large scale, landscapes may represent the incremental process of turning crude ore into an economic commodity, and the engineered facilities to do so.

Area of Significance: Industry: The Area of *Industry* is fundamental. Mining landscapes are tied to and representations of the mining industry, the most important factor in exploration and development of the corridor. The industry was the principal force behind the corridor's economy, infrastructure, permanent settlement, and development. Further, the industry and its impacts on the land made Clear Creek drainage one of Colorado's most productive sources of mineral wealth. Prospectors and mining outfits adapted known methods and technology to the drainage's physical environment, geology, and mineralogy. Through their efforts, they contributed to the development of mining technology and engineering in numerous ways. Many were subsequently adopted widely and forwarded mining and infrastructure elsewhere. Some of the innovations were small in scale such as individual pieces of machinery or structures. Others were macro in scale such as enormous mining and milling systems.

Area of Significance: Transportation: Mining depended on transportation systems to haul supplies to the mines, ore to mills, and finished products to market. Because of this, the mining

industry fostered networks of packtrails, roads, and railroads in the corridor. The transportation systems were significant to mining and that industry's impact on the land. The systems were also significant because they affected other industries, settlement, historic trends, and land use. Rural Historic Mining Landscapes often exhibit elements of transportation systems characteristic of mining.

Rural Historic Mining Landscape Registration Requirements

To qualify for the NRHP, a landscape must meet at least one of the Criteria listed below, and possess related physical integrity.

Criterion A: A landscape and its contributing resources may qualify for eligibility under Criterion A if associated with important trends and events. The landscape must retain integrity relative to the Period of Significance for mining in the corridor.

Criterion B: Small-scale landscapes such as individual mines or milling complexes may be eligible under Criterion B when directly associated with the life of an important person significant to our past. Association could be through residence, employment, or other involvement. The associated resource must retain physical integrity relative to that person's productive life. In some cases, important people invested in mining companies or owned land but did not occupy the property. Such an association does not meet the registration requirements for Criterion B. The individual of note must have been present on the ground for a sustained period of time. Larger-scale landscapes are less easily documented under Criterion B generally, as they evolved organically through the actions of numerous people.

Criterion C: Mining landscapes may be eligible under Criterion C if buildings, structures, their archaeological remains, and natural features represent mining, its subsidiary industries, or settlement patterns. Landscapes occupied for extended periods of time reflect evolution in land use, while those occupied for a narrow period reflect land use patterns of that era. Intact buildings and structures can be significant and often rare contributing elements of mining landscapes. Most individual resources comprising the landscape should retain integrity at least on an archaeological level. Modern intrusions should either be minimal or compatible with the historic land use. The researcher must discuss how the landscape's characteristics and contributing elements represent an aspect of the mining industry.

Criterion D: Landscapes may be eligible under Criterion D when likely to contribute meaningful information based on a holistic representation of buildings, structures, or archaeological features. The areas of inquiry can be broad, relying on information offered by the landscape as a whole. If residential complexes within the landscape possess building platforms, privy pits, and refuse dumps with buried archaeological deposits, testing and excavation may reveal important information regarding lifestyle and demography of the occupants. When information from multiple complexes is compared, regional patterns may become apparent. Important areas of inquiry include but are not limited to diet, health, distribution of gender, families, ethnicities, professional occupation, and socioeconomic status. Comparative studies of industrial sites may reveal patterns in systems engineering, ore treatment processes, and equipment. Other patterns regarding construction methods, materials, design, and architecture

may emerge. Such information can be compared to geology, mineralogy, and the successful or failed operations for a full understanding of a region's industry. Intact underground mine workings is another area of inquiry under Criterion D. Groups of mines may feature connected workings that can contribute to the understanding of broad-scale mine engineering, planning, and operations.

Historic landscapes eligible for the NRHP must possess physical integrity relative to the Period of Significance outlined above. Landscapes in the corridor changed in varying degrees through continuity in use, as well as deterioration of resources following abandonment. Overt modern intrusions can compromise integrity if out of keeping with land use patterns characteristic of historic mining. Such intrusions should be few and unobtrusive. The presence of some landscape characteristics is more important to integrity than others. Historic settlement patterns, vegetation patterns, circulation systems, and small-scale features typical of mining should be present. Because the natural environment was a prominent backdrop for mining during the Period of Significance, a preserved natural setting is important to integrity.

Many of the seven aspects of historic integrity defined by the NRHP apply to mining landscapes, although not all need be present. *Location* is the place where significant activities that shaped land took place, remaining apparent. To retain integrity of *design*, the landscape features, both manmade and natural, must convey organization and planning relative to mining land use. *Setting* is the physical environment surrounding a historic property. Both large-scale and small-scale features form a setting conveying mining land use and settlement patterns. To retain integrity of setting, a landscape and bordering area must not have changed a great degree in overall character. To retain integrity of *feeling*, the landscape should convey mining and associated settlement. Integrity of *association* exists where a combination of natural and manmade features conveys a connection between the landscape and a contemporary observer's ability to discern the historic mining industry and settlement.

MINING INDUSTRY SITE FEATURES

Placer Mine Feature Types

Placer mine sites primarily consist of excavations and tailings piles. Occasionally, company placers may also possess archaeological features remaining from buildings and infrastructure. The most common aspects are described below. For context, researchers should review Section A 1.4, and *The Mining Industry in Colorado* Multiple Property Documentation Form.

Boom Dam: A dam intended to impound water for booming operations. Boom dams often featured a spillway or other form of breach that directed water into a boom ditch or drainage.

Boom Ditch: A ditch that directed water from a boom dam directly into placer workings.

Building Platform: A flat area that supported a building.

Building Ruin: The collapsed remains of a building.

Collection Ditch: A ditch that collected runoff from a placer mine for secondary uses or to impound sediments. A collection ditch should be located downstream from a placer mine.

Cut-Bank: The headwall of an excavation.

Dam: A water impoundment structure. Some dams for placer mines are earthen while others may consist of log cribbing filled with earth.

Ditch: An excavation that carried water to or from a placer mine. Ditches often tapped streams in adjacent drainages and featured a gentle gradient.

Flume: A wooden structure that carried water to or from a placer mine or carried a stream around a placer mine.

Flume Remnant: The structural remnants of a flume.

Monitor Station: A platform, tongue of earth, or perch where a hydraulic monitor was stationed. Monitor stations were usually strategically located amid hydraulic workings.

Penstock: A pipeline that carried water under great pressure for hydraulic mining. The penstock descended steeply from a pressure box down to the hydraulic workings, where feed pipes connected with hydraulic monitors. The penstock had gradual reductions in diameter, which increased the velocity and pressure of the water within.

Placer Pit: An excavation circular or ovoid in footprint where miners sought deep gravel.

Placer Trench: A linear excavation where miners sought deep gravel.

Placer Tailings: The hallmark of placer mining, tailings usually consist of ovoid or linear piles of gravel and rounded river cobbles.

Pressure Box: A wooden or masonry structure, usually far upslope from a hydraulic mine, that directed water into a penstock featuring a steep descent. A ditch or pipeline carried water to the pressure box from a stream or reservoir. The pressure box's elevation and the penstock's descent provided enough pressure for hydraulic mining.

Refuse Dump: A collection of industrial and structural debris cast off during operations.

Reservoir: A void behind a dam for water storage.

Shop Platform: An earthen platform that supported a shop building, which can be defined by artifacts such as shop refuse and coal.

Shop Ruin: A collapsed shop.

Shop Refuse Dump: A deposit of shop refuse such as anthracite coal, forge-cut iron scraps, hardware, and forge clinker, which is a scorious residue generated by burning coal.

Sluice: Similar to a flume, a sluice was a lengthy wooden structure with a plank floor and walls, and the floor featured riffles for collecting gold. Piles of rocks and timber piers typically supported the sluice, which was usually located at the bottom of a drainage.

Sluice Remnant: The remnants of a sluice, usually denoted by piers, posts, rock supports, and planks.

Supply Ditch: A ditch that delivered water to a placer mine.

Work Station: A platform alongside a sluice where workers supervised operations and maintained the sluice.

Hardrock Prospect Feature Types

Hardrock Prospect Buildings

Hoist House – Typical Character-Defining Features

Hoist houses, associated with shaft operations, enclosed a hoist, its power source, and often a blacksmith shop. Most prospect outfits followed a form conventional to the mining industry, which was a rectangular footprint and a front-gabled or shed roof. Hoist houses were vernacular in that they followed no recognized architectural style, consisted of available materials, and were built as needed by the outfit.

- Core Plan: Rectangular or square.
- Stories: 1
- Foundation: Log or timber footers on earthen platform.
- Walls: Early hoist houses had walls of horizontal logs, assembled with square, V, or saddle-notch joints. From the 1890s through 1910s, most were frame construction sided with planks or corrugated sheet iron over plank sheathing. During the 1930s, the walls may have consisted of planks nailed to cross-members, and joined at the corners to form the building.
- Roof: Front-gabled or shed form, supported by rafters, with plank decking and corrugated sheet iron, plank, or rolled asphalt cladding. Roof may feature angled cupola for passage of hoist cable.
- Chimney: Stovepipe for stove and blacksmith forge.
- Entry Door: Located in the front or side elevation, offset from center. Doors may have been salvaged factory-made panel versions or, more often, custom-made of planks.
- Windows: Fixed or sliding in any of the walls, made of milled lumber. May be salvaged from elsewhere. Fixed window, oriented vertically, high in front wall for visual of headframe.

Shop – Typical Character-Defining Features

Located near the adit portal or shaft collar, a shop was a building enclosing blacksmith facilities where a worker fabricated and maintained tools and hardware. Simple shops usually featured a forge, a workbench, and possible hand-powered appliances such as a drill press. Most prospect outfits followed a form conventional to the mining industry, which was a rectangular footprint and a gabled roof. Shops were vernacular in that they had no recognized architectural style, consisted of available materials, and were built as needed by the outfit. In general, logs were commonly used prior to 1890 and lumber as early as 1880. Blacksmith debris and forge clinker are usually within.

- Core Plan: Rectangular or square.
- Stories: 1
- Foundation: Log or timber footers on earthen platform.
- Walls: Early shops had walls of horizontal logs, assembled with square, V, or saddle-notch joints. From the 1890s through 1910s, most were frame construction sided with planks or corrugated sheet iron over plank sheathing. During the 1930s, the walls may have consisted of planks nailed to cross-members, and joined at the corners to form the building.
- Roof: Gabled or shed form. On early shops, construction was often planks laid over log beams. By 1890, construction was commonly rafters, plank decking, and corrugated sheet iron, plank, or rolled asphalt cladding.
- Chimney: Stovepipe for blacksmith forge.
- Entry Door: Located in the front or side elevation. Doors may have been salvaged, factory-made panel versions or, more often, custom-made of planks.
- Windows: Fixed or sliding in any of the walls, made of milled lumber. May be salvaged from elsewhere.

Hardrock Prospect Features

Boiler: A boiler was a vessel that generated the steam that powered machinery. Most boilers at prospect sites will be temporary-class upright, locomotive, or Pennsylvania types discussed in Section A 1.4.

Boiler Foundation: Because portable boilers were self-contained and free-standing, prospect outfits usually stood them on platforms located near the hoist. Occasionally, however, workers erected rock or brick foundations or pads to support the boiler. The artifact assemblage around a foundation or platform can help the researcher identify it as that for a boiler. The assemblage should include clinker, which was a scoriaceous, dark residue, as well as unburned bituminous coal, ash, water-level sight-glass fragments, boiler grate fragments, and pipe fittings.

Some prospect outfits installed upright boilers on square or circular dry-laid rock pads or excavated a shallow pit underneath the boiler to allow ashes from the firebox to drop through. The pad's size should approximate the boiler's diameter. Pennsylvania boilers and locomotive boilers stood on skids, which usually required no support. However, where the ground was soft or uneven, workers often laid parallel rock alignments to prevent the boiler from settling. In the absence of rock supports, the skids occasionally became embedded in the ground and left two parallel depressions the length and width of the boiler. For locomotive boilers without skids, which were rare, workers erected a rock or brick pylon to support the high rear, and laid a rock or brick pad that supported the firebox end.

Claim Marker: Prospectors erected claim markers at the corners of their claims. Some were 300'x1,500' in area, and others were 500'x1,500' in area. Markers ranged from cairns to blazes on trees to up-ended boulders. When a surveyor mapped and registered a claim, he usually etched the mineral survey number into a corner rock.

Claim Stake: A claim stake was the universally recognized form of claim marker. Claim stakes were usually 4"x4" posts 4' high, although prospectors often substituted logs.

Draft Animal Track: Horse whims required a circular track around the apparatus so the draft animal could wind the cable drum. The tracks tended to be around 20' in diameter and cleared of major obstacles. Prospectors often graded semicircular platforms adjacent to a shaft for a track.

Forge: Nearly all prospect operations of substance featured a forge where a blacksmith heated steel implements. Most forges were vernacular in construction in that they were assembled with local materials. Prospectors built walls 3'x3' in plan and 2' high with rocks or small logs, inserted a tuyere, and filled the interior with sorted gravel. In some cases, prospect outfits imported factory-made iron pan forges to their sites.

Forge Remnant: Forges collapsed over time and may manifest as a mound of gravel and remnants of the walls, usually impregnated with coal and forge clinker. When coal burned at high temperatures, it left a scoriaceous, dark residue known as *clinker*.

Headframe: A frame made of timber or logs that stood over a shaft. Headframes associated with horse whims were often large tripods or tetrapods. Power hoisting systems usually employed two-post gallows headframes. All are discussed in Section A 1.4.

Headframe Ruin: The collapsed remnants of a headframe.

Headframe Foundation: Headframe foundations usually manifest as parallel timbers that flank a shaft and extend toward the area where a hoist was located.

Hoist: Hoists at prospects were usually horse whims, steam, petroleum, or small electric models. See Section A 1.4.

Hoist Foundation: Nearly all mechanical hoists were anchored to foundations to keep them in place, and a foundation's footprint can reflect the type of hoist. Foundations are common at prospect shaft sites and can usually be found aligned with and at least 20' from the shaft. Because of the ease of construction and low cost, prospectors usually assembled hoist foundations with timbers and occasionally with stone or concrete. Timber foundations decay and become buried over time, and often manifest today as rectangular groups of four to six anchor bolts projecting out of a hoist house platform.

Horse whims were usually bolted to timber foundations 2'x2' in area at the bottom of a shallow pit. The trench for the cable and linkages often extends from the pit to the shaft.

Foundations for single-drum steam hoists are usually rectangular, flat, and feature at least four anchor bolts. They can range in size from 6'x6' to as little as 2'x3' in area. Foundations for single-drum electric hoists appear very similar to those for steam hoists. Steam hoists often left behind plumbing and gaskets, and the site should possess evidence of an associated boiler. The use of electric hoists often generated electrical insulators and wires.

Foundations for gasoline hoists are fairly distinct. Their footprint is that of an elongated rectangle at least 2'x6' in area oriented toward and aligned with the shaft. Due to the engine's severe vibrations, prospectors often bolted hoists to concrete foundations at least 1' high. Gasoline hoist foundations usually feature at least two rows of three anchor bolts, with the rear two closer together than the rest. Gasoline hoists can leave distinct artifact assemblages including thin wires, spark plugs, small pipes, and fine machine parts.

Hoist House Platform: Hoist houses stood on platforms of leveled earth or waste rock at least 20' from, and aligned with, the shaft. Often, a platform is all that represents a hoist house, and it usually reflects the building's size and footprint. Evidence of a hoist and a shop is usually present.

Hoist House Ruin: The collapsed remnants of a hoist house.

Horse Whim: A horse whim was the most primitive type of mechanical hoist, and it was powered by a draft animal. Two types of whims were popular at different times (discussed above), and the researcher should specify the type of whim when recording a site. The *horizontal reel whim* consisted of a horizontally oriented cable reel at least 3' in diameter, fitted with a harness beam on top. The *geared whim* was compact and featured a vertical cable drum in a frame. A capstan, geared to the drum, featured a harness beam on top.

Horse Whim Pit: Prospectors often placed horse whims in shallow pits so the hoisting cable could pass through a trench to the headframe and pose no obstacle to the encircling draft animal. They often lined the pits with planks or logs to retain soil. Over time, the lining collapsed, leaving a concave depression where the whim was anchored and a linear depression extending to the shaft. The pit should be at the center of a draft animal track.

Mine Rail Line: A track for ore cars.

Mine Rail Line Remnant: When prospectors dismantled a track, they often left in-situ ties, impressions of ties, and sections of rails.

Pack Trail: A path less than 8' wide that provided access to prospect workings.

Prospect Adit: A horizontal entry underground denoted by a waste rock dump. An adit tended to be short and less than 3'x6' in-the-clear, while a tunnel was larger. When collapsed, adits appear as trenches.

Prospect Pit: A circular or ovoid excavation surrounded by a small volume of waste rock.

Prospect Shaft: A vertical or inclined opening underground of shallow depth. When intact, shafts tend to be rectangular, and either 4'x6' or 4'x8' in-the-clear, the interior dimension. When collapsed, shafts manifest as circular areas of subsidence.

Prospect Trench: A linear excavation flanked by a small volume of waste rock.

Shop Platform: Shops usually stood on earthen platforms near the entry underground. The platforms may feature forge remnants and almost always possess artifacts such as forge-cut iron scraps, anthracite coal, and clinker, which is a scorious, ashy residue created by burning coal.

Shop Ruin: The collapsed remnants of a shop.

Waste Rock Dump: The waste material removed from underground workings.

Hardrock Mine Feature Types

Mine sites can possess an array of archaeological, engineering, and architectural features representing their historic surface plants. The most common manifestations are explained as the Feature Types below. In support of identification and interpretation, they are arranged under the common systems comprising mine surface plants. Researchers should also review Prospect Site Feature Types, Section A 1.4, and *The Mining Industry in Colorado* Multiple Property Documentation Form for context.

Hardrock Mine Buildings

Compressor House – Typical Character Defining Features

Some large mines featured compressor houses specifically to shelter an air compressor, its power source, and associated components. The buildings postdate 1880 when rockdrills were adopted for boring blast-holes, and were common at large mines by 1900.

Compressor houses were vernacular in their industrial appearance, emphasis on function, and custom design often by the mining company. Although each was unique, they were based on several forms conventional to the mining industry. The most basic was rectangular in footprint with a front-gabled or shed roof and broad doors in front. Large compressor houses may have been L-shaped with the additional room used for storage or a shop.

- Core Plan: Rectangular or L.
- Stories: 1.
- Foundation: Log or timber footers on earthen platform for small buildings, and stone masonry or concrete under large versions.
- Walls: Frame construction sided with board-and-batten, planks, or corrugated sheet iron over plank sheathing.
- Roof: Gabled or shed form consisting of rafters, plank decking, and corrugated sheet iron, plank, or rolled asphalt cladding.
- Chimney: Pipes for compressor air intake. Steel smokestack for boiler.
- Entry Door: Located in the front and side elevation, doors were broad and custom-made of planks.
- Windows: Fixed, sliding, sash in any of the walls, made of milled lumber. May be salvaged from elsewhere.

Hoist House – Typical Character Defining Features

Hoist houses, associated with shaft operations, enclosed a hoist, its power source, and often a blacksmith shop. Most prospect outfits followed a form conventional to the mining industry, which was a rectangular footprint and a front-gabled or shed roof. Hoist houses were vernacular in that they followed no recognized architectural style, consisted of available materials, and were built as needed by the outfit.

- Core Plan: Rectangular or square.
- Stories: 1
- Foundation: Log or timber footers on earthen platform.
- Walls: Early hoist houses had walls of horizontal logs, assembled with square, V, or saddle-notch joints. From the 1890s through 1910s, most were frame construction sided with planks or corrugated sheet iron over plank sheathing. During the 1930s, the walls may have consisted of planks nailed to cross-members, and joined at the corners to form the building.
- Roof: Front-gabled or shed form, supported by rafters, with plank decking and corrugated sheet iron, plank, or rolled asphalt cladding. Roof may feature angled cupola for passage of hoist cable.
- Chimney: Stovepipe for stove and blacksmith forge.
- Entry Door: Located in the front or side elevation, offset from center. Doors may have been salvaged, factory-made panel versions or, more often, custom-made of planks.
- Windows: Fixed or sliding in any of the walls, made of milled lumber. May be salvaged from elsewhere. Fixed window, oriented vertically, high in front wall for visual of headframe.

Privy – Typical Character Defining Features

- Core Plan: Rectangular or square.
- Size: 3'x4' to 5'x8' in plan.

- Foundation: Log or timber posts, log footers, or corner rocks around open pit.
- Walls: Post-and-girt frame, or corner posts with cross-members, plank or board-and-batten siding on the exterior.
- Roof: Front or side-gabled, or shed, with plank decking, and rolled asphalt, asphalt shingles, or smooth or corrugated metal. Decking may span the walls or be fastened to 2" thick wood rafters.
- Entry Door: Entries were usually vertical plank doors, sometimes opening onto a plank deck.

Shaft House – Typical Character Defining Features

A shaft house was a large building enclosing the shaft collar, the hoisting system, and usually a shop. Large shaft houses may have also encompassed an air compressor. Mine tracks extended away from the shaft and passed out of the building to ore bins and waste rock dump.

Like typical mine buildings, shaft houses were vernacular in design and construction. They had no recognized architectural style, were assembled from available materials, and built for function. Although each was unique in design, they were based on a handful of forms conventional to the mining industry. The most basic was rectangular in footprint with a front-gabled or shed roof and a cupola for the headframe. Large shaft houses may have been L-shaped, cross in plan, or possessed multiple extensions for hoist, boiler, and shop. The roof was highest over the headframe and sloped down toward the hoist. Logs were commonly used for small buildings prior to 1890, and lumber was used for large shaft houses as early as 1880.

- Core Plan: Rectangular, L, crossed, or complex/irregular.
- Stories: 1 with vaulted interior and cupola over headframe.
- Foundation: Log or timber footers on earthen platform for small buildings, and stone masonry or concrete under large versions.
- Walls: Early shaft houses had walls of horizontal logs, assembled with square, V, or saddle-notch joints. From the 1890s through 1910s, most were frame construction sided with board-and-batten, planks, or corrugated sheet iron over plank sheathing.
- Roof: Gabled or shed form. On early shaft houses, construction was often planks laid over lumber rafters and beams. By 1890, construction was commonly rafters, plank decking, and corrugated sheet iron, plank, or rolled asphalt cladding. Cupola over headframe.
- Chimney: Stovepipes for blacksmith forge and heating stove. Steel smokestack for boiler.
- Entry Door: Located in the front and side elevation, doors were broad and custom-made of planks.
- Windows: Fixed, sliding, sash in any of the walls, frames made of 1" or 2" thick milled lumber.

Shop – Typical Character Defining Features

Nearly every mine had a shop for the manufacture and repair of tools, hardware, and machinery. Shops included blacksmith facilities at the least; some were equipped with power-driven appliances for advanced work, and many were equipped for basic carpentry. To minimize handling of heavy iron, mining companies built their shops near the mine opening. Shop buildings followed several basic vernacular forms in construction, appearance, and design. Most were custom facilities, built as needed with available materials, and planned according to a company's interpretation of function and efficiency. Prior to the 1890s, shops tended to be simple, rectangular, and had blacksmithing equipment in a major portion and a carpentry area in the rest. Many were of log construction, but mining companies preferred frame construction. During the 1890s, shops increased in size to accommodate more appliances, and by 1900, corrugated sheet iron grew in popularity for siding and roofs. Blacksmith and metal-working refuse should lie in and around the shop.

- Core Plan: Rectangular, L, or square.
- Stories: 1
- Foundation: Log or timber footers on earthen platform at small shops, and stone masonry or concrete at large shops. Timber or concrete pads for shop appliances are often within the main foundation.
- Walls: Early shops had walls of horizontal logs, assembled with square, V, or saddle-notch joints. From the 1890s through 1910s, most were frame construction sided with board-and-batten, planks, or corrugated sheet iron over plank sheathing. During the 1930s, the walls may have consisted of planks nailed to cross-members and joined at the corners to form the building.
- Roof: Gabled or shed form. On early shops, construction was often planks laid over log beams. By 1890, construction was commonly rafters, plank decking, and corrugated sheet iron, plank, or rolled asphalt cladding.
- Chimney: Stovepipe for blacksmith forge.

- Entry Door: Located in the front or side elevation. Doors were broad and custom-made of planks.
- Windows: Fixed or sliding in any of the walls, frames made of 1” or 2” thick milled lumber. May be salvaged from elsewhere.

Stable – Typical Character Defining Features

Mining companies relied on draft animals for both underground and surface transportation. The companies erected stables to house the animals, and the buildings were often crude, low, and erected on poorly leveled ground. Distinguishing characteristics include wide doorways, stalls, feed mangers, and oat boxes.

- Core Plan: Rectangular or square.
- Stories: 1
- Foundation: Log or timber footers on earthen platform.
- Walls: Early stables had walls of horizontal logs, assembled with square, V, or saddle-notch joints. Chinking is absent. From the 1890s through 1910s, some stables were frame construction sided with planks or corrugated sheet iron over plank sheathing. During the 1930s, the walls may have consisted of planks nailed to cross-members and joined at the corners to form the building.
- Roof: Gabled or shed form. On early stables, construction was often planks laid over log beams. By 1890, construction was commonly rafters, plank decking, and corrugated sheet iron, plank, or rolled asphalt cladding.
- Chimney: None.
- Entry Door: Located in the front or side elevation, doors were broad and custom-made of planks.
- Windows: Fixed or sliding in any of the walls, frames made of 1” or 2” thick milled lumber. May be salvaged from elsewhere.

Transformer House – Typical Character Defining Features

Companies that employed electricity for lighting and power often erected transformer houses to shelter electrical equipment. They usually located the building away from the rest of the surface plant in case of fire. Transformer houses are relatively small, rarely exceeding 30’x30’ in plan, and usually feature brackets and mounts on posts for the transformers, as well as ports in the walls and numerous insulators for wires.

- Core Plan: Rectangular or square.
- Stories: 1
- Foundation: Log or timber footers on earthen platform.
- Walls: Most were frame construction sided with corrugated sheet iron over plank sheathing. Insulator brackets and ports for wires are common.
- Roof: Gabled or shed form. Construction was commonly rafters, plank decking, and corrugated sheet iron cladding.
- Chimney: None.
- Entry Door: Located in the front or side elevation, doors may have been custom-made of planks or corrugated sheet iron.
- Windows: Small transformer houses lacked windows. Large buildings may have features ore of two fixed units in any of the walls.

Tunnel House – Typical Character Defining Features

A tunnel house was a building enclosing the tunnel portal, a shop, timber-dressing area, flume for mine drainage, and sometimes an ore sorting station. Large tunnel houses may have also encompassed an air compressor. Mine tracks extended from the tunnel through the building and out to ore bins and waste rock dump.

Like typical mine buildings, tunnel houses were vernacular in design and construction. They followed no recognized architectural style, were assembled from available materials, and built for function. Although each was unique in design, they were based on a handful of forms conventional to the mining industry. The most basic was rectangular in footprint with a front-gabled or shed roof and broad doors in front of the tunnel. Large tunnel houses may have been L-shaped or possessed multiple extensions for shop, compressor, boiler, and ore sorting. Logs were commonly used for small buildings prior to 1890, and lumber for large tunnel houses as early as 1880.

- Core Plan: Rectangular, L, or complex/irregular.
- Stories: 1 with vaulted interior.
- Foundation: Log or timber footers on earthen platform for small buildings, and stone masonry or concrete under large versions.

- Walls: Early tunnel houses had walls of horizontal logs, assembled with square, V, or saddle-notch joints. From the 1890s through 1910s, most were frame construction sided with board-and-batten, plank, or corrugated sheet iron over plank sheathing.
- Roof: Gabled or shed form. On early tunnel houses, construction was often planks laid over lumber rafters and beams. By 1890, construction was commonly rafters, plank decking, and corrugated sheet iron, plank, or rolled asphalt cladding.
- Chimney: Stovepipes for blacksmith forge and heating stove. Steel smokestack for boiler.
- Entry Door: Located in the front and side elevation, doors were broad and custom-made of planks.
- Windows: Fixed, sliding, sash in any of the walls, frames made of 1" or 2" thick milled lumber. May be salvaged from elsewhere.

General Hardrock Mine Feature Types

Adit: A horizontal opening usually less than 3'x6' in-the-clear. Collapsed adits manifest as linear areas of subsidence. Tunnels were larger horizontal openings greater than 3'x6' in-the-clear.

Building Platform: A flat area upon which a building stood. If possible, the type of building should be specified in the feature description.

Cribbing: A latticework of logs usually intended to be filled with waste rock or earth. Some cribbing structures served as retaining walls for platforms and waste rock dumps, and others were foundations.

Explosives Magazine: Organized mining outfits erected magazines to store explosives away from a mine's surface plant. Some magazines were dugouts, some were stout stone structures, while others were no more than small sheds much like dog houses.

Machine Foundation: A timber, masonry, or concrete foundation for an unknown type of machine.

Mine Track: A rail line that facilitated the movement of ore cars around a mine.

Mine Track Remnant: When a rail line was dismantled, workers often left ties, impressions from ties, portions of rails, and the rail bed.

Pipeline: An assembly of pipes usually intended to carry water. Pipelines should not be confused with compressed air mains, which extended from a compressor into the underground workings.

Pipeline Remnant: When disassembled, pipelines left evidence such as linear depressions, series of footers, and lengths of pipe.

Privy Pit: A privy pit was the waste receptacle underneath a privy building. When a pit was full, workers relocated the building, sometimes threw refuse into the depression, and covered it with a cap of earth or waste rock. Pits tend to manifest today as depressions less than 5' in diameter, often with artifacts and other materials in their walls and bottoms.

Refuse Dump: A collection of hardware, structural materials, and other cast-off items.

Road: Roads were graded for wagons and trucks and were usually at least 8' wide.

Shaft: A vertical or inclined opening underground usually at least 4'x8' in area. Some shafts were divided into compartments. The largest compartment was the *hoisting compartment* and the smaller, usually less than 3' wide, was the *utility compartment*. Highly productive mines may have featured shafts with two hoisting compartments and one utility compartment. Evidence of a double-drum hoist should be associated with a three-compartment shaft. Collapsed shafts manifest as funnels of subsidence.

Shaft House Platform: Shaft houses usually stood on leveled platforms of earth or waste rock. When dismantled, shaft houses left distinct footprints surrounding evidence of the hoist, boiler, and shop. Differences in soil types and consistencies can reflect a shaft house's footprint. Large shaft houses often stood on rock foundations that can define the structure's perimeter.

Shaft House Ruin: The collapsed remains of a shaft house.

Stable Ruin: The collapsed remnants of a stable.

Timber Dressing Station: Timber dressing stations were work areas where miners reduced logs into timbers for underground support. Most stations were outdoors near the mine opening, and they tend to be represented by collections of raw logs and numerous cut wood scraps. Some were within the shaft house or tunnel house.

Timber Stockpile: A stockpile of mine timbers, often located near the mine opening. Mine timbers are usually 6'x7' long and notched at both ends.

Trestle: A structure that supported a mine rail line, walkway, or pipeline. Workers often built small trestles on the flanks of waste rock dumps to support dead-end rail lines.

Trestle Remnant: Posts, single piers, or partial stringers left from a trestle.

Tunnel: A tunnel was a horizontal entry underground 3'x6' in-the-clear (interior dimensions) or larger. Collapsed tunnels often manifest as linear areas of subsidence, possibly with pipes or rails projecting outward.

Tunnel House Platform: Tunnel houses commonly stood on cut-and-fill platforms graded at the tunnel portal. Large versions often had rock or concrete foundations. The platform or foundation, as well as differences in soil types and consistencies, can reflect the building's footprint. Artifacts and machine foundations can reveal the types of facilities that the building enclosed.

Tunnel House Ruin: The collapsed remains of a tunnel house.

Utility Pole: A pole that supported an electrical or communication line.

Ventilation Blower: Many operations employed ventilation blowers to force fresh air underground. They usually located the blower adjacent to the mine opening and attached an assemblage of ventilation tubes that extended underground. Large blowers had to be anchored to foundations, and most were belt-driven by an adjacent motor or steam engine.

Ventilation Blower Foundation: Blower foundations usually consisted of timbers, were 3'x4' in area or less, and featured four anchor bolts. The foundations were embedded in the ground adjacent to the mine opening. A motor or small steam engine that powered the blower was usually bolted to an adjacent foundation.

Compressed Air System Feature Types

Air Compressor: An air compressor was a machine that compressed air that was piped underground to power rockdrills. Mining companies employed a variety of types that rose and fell in popularity between the 1870s and 1940s. For a list of types, their descriptions, and popularity age ranges, see Section A 1.4.

Air Compressor Foundation: Because of their great weight and powerful motion, air compressors had to be anchored to solid foundations. Workers often constructed timber foundations for small compressors and used either rock or brick masonry, or concrete for large models. Based on a foundation's footprint, the researcher can often determine the exact type of compressor. The foundations for the types of compressors are described in Section A 1.4.

Compressed Air Main: A pipeline that carried compressed air from a compressor into the underground workings.

Compressor House Platform: The platform that supported a compressor house. Compressor house platforms should feature a compressor foundation, a motor mount or boiler setting remnant, and an artifact assemblage consisting of machine parts and pipe fittings.

Compressor House Ruin: The collapsed remains of a compressor house.

Hoisting System Feature Types

Headframe: Mining operations erected four general types of headframes to meet the needs of ore production. The first is an enlarged version of the two-post gallows discussed above with Prospect Shafts. The second was the *four-post derrick*, which consisted of four posts joined with cross-braces and diagonal beams, all supported by two back braces. The third is the *six-post derrick*, which featured six posts instead of four. The last is a large *A frame*. Production-class headframes were more than 30' high and stood on well-built timber foundations.

Headframe Foundation: Foundations for production-class headframes consisted of a timber frame usually embedded in the waste rock surrounding a shaft. The timbers flanked the shaft and extended toward the area where the hoist was located. The foundation's length usually equaled the headframe's height.

Headframe Ruin: The collapsed remnants of a headframe.

Hoist: To meet the needs of ore production, mining companies engaged in production almost always employed power hoists. See Section A 1.4 for types, descriptions, and age ranges for hoists.

Hoist Foundation: Few shaft mines retain their hoists and instead feature foundations, which are distinct today. The foundations for specific types of hoists are discussed in Section A 1.4.

Hoist House Platform: See Prospect Site Feature Types.

Hoist House Ruin: See Prospect Site Feature Types.

Power System Feature Types

Boiler: Many small, marginal mining operations employed portable boilers to power hoists and minor pieces of equipment, as did prospect outfits. However, mining companies wishing for a permanent, efficient source of steam usually installed return-tube boilers. For descriptions, see Section A 1.4.

Boiler Foundation: Boilers were usually dismantled when a mine closed, and in some cases, the masonry setting was removed as well. Distinct pads and footers may remain, and the type of boiler can be determined from this foundation. Artifacts such as ash, clinker, and scorched rocks and bricks are usually associated with boiler foundations. When portions of the setting remain, the researcher should record them as a *Boiler Setting Ruin*, discussed below.

Portable boilers left the most elementary foundations. Vertical boilers stood on dry-laid brick or stone pads, and workers arranged rock alignments for the skids of locomotive units. Some locomotive boilers lacked skids and instead were supported by simple rock or brick pylons, discussed above under prospects.

Typical return-tube boiler foundations were, flat, rectangular, and around 10'x22' in area. Workers usually used rocks, although well-funded companies substituted bricks. In many cases a foundation may still retain the *bridge-wall*, which was a low row of bricks that forced flue gases against the boiler's belly. When visible, the bridge-wall crosses the foundation near its center.

Boiler Setting Ruin: When workers dismantled return-tube boilers, they almost always left the masonry setting. The structure rarely remained intact, however, and collapsed to some degree, becoming a *boiler setting ruin*. Collapsed settings range in appearance from mostly intact walls to mere piles of rubble. With some examination, the researcher may be able to determine the boiler type and location of the firebox. If the walls are intact, a ruin may feature the masonry bolts that anchored the façade, and the posts that supported the boiler shell. Most setting ruins also feature a bridge-wall, which was a low brick divider in the setting's interior. The wall usually stood between the firebox and the smoke chamber, and it forced flue gases up against the boiler's belly. Most return-tube boiler settings consisted of common bricks or rocks, and they featured cleaning ports near ground-level. Well-capitalized companies often lined fireboxes with fire bricks.

Boiler Clinker Dump: When workers shoveled residue out of a boiler's firebox, they usually dumped the material on the waste rock dump near the boiler. Boiler clinker dumps tend to be distinct and consist primarily of boiler clinkers, which are dark, scoriaceous, ashy clasts created by burning coal. Boiler clinker dumps also usually include charred slate fragments, unburned bituminous coal, and structural and industrial hardware.

Motor: The common motor consisted of a cylindrical body, a belt pulley, and electrical wiring. Most motors were less than 4'x5' in area.

Motor Foundation: Due to great weight and stresses created by motion, workers anchored motors to stout concrete foundations usually less than 4'x5' in area. Foundations tend to be slightly rectangular, feature four to six anchor bolts, and are aligned with the machine that the motor powered.

Transformer House Platform: Workers usually erected transformer houses on cut-and-fill platforms that appear to be generic, except for a high proportion of electrical artifacts. Examples include cast-iron transformer cases, porcelain or slate switch panel fragments, fuses, porcelain insulators, high-voltage porcelain insulators, glass insulators, and wires.

Transformer House Ruin: The collapsed remnants of a transformer house.

Ore Storage and Processing Feature Types

Ore Bin: Mining outfits erected ore bins to contain payrock for shipment. Ore bins could be of the sloped-floor variety or open, flat-bottom structures. For a description of ore bin types, see Section A 1.4.

Ore Bin Platform or Foundation: A platform or foundation that supported an ore bin. Open, flat-bottom bins usually stood on a platform located on the flank of a waste rock dump so workers could dump payrock from an ore car. Sloped-floor bins usually stood on a combination of a platform, which supported the bin's head, and log or timber pilings that supported the remainder.

Ore Bin Ruin: The collapsed or partial remnants of an ore bin.

Ore Chute: A chute that directed payrock into an ore bin or into a vehicle.

Ore Chute Remnant: The collapsed remnants of an ore chute.

Ore Sorting House: Ore sorting houses, discussed in Section A 1.4, were complex structures that featured an ore bin at bottom, an overlying sorting room, and bins or chutes at top to receive raw ore.

Ore Sorting House Platform or Foundation: Platforms and foundations for sorting houses usually appear similar to those built for ore bins. The difference can manifest as discrete piles of large waste cobbles flanking the foundation. The piles are often different in appearance from the rest of the mine's common waste rock, and often consist of rough cobbles uniform in size.

Ore Sorting House Ruin: The collapsed remnants of a sorting house.

Shop Feature Systems

Backing Block: Some shops featured backing blocks to help workers sharpen the drill steels used by rockdrills. A backing block consisted of an iron rod 4"x4" or less in cross-section and up to 8' long embedded in the shop floor near the forge. The block's surface featured a series of deep divots where the blacksmith rested the drill-steel's butt, and he leaned the drill-steel's neck against an anvil to brace the item for sharpening. Many mining outfits substituted a railroad rail for the iron rod.

Drill-Steel Sharpening Machine: During the 1910s, well-funded mining companies began adopting compressed air-powered machines to automate the process of sharpening drill-steels. Most sharpeners were upright units 2'x3' in area, 3'x5' high, and featured an assemblage of clamps and power hammers mounted on a cast iron pedestal. Sharpeners were always located in a shop.

Drill-Steel Sharpening Machine Foundation: Because drill-steel sharpening machines destroyed unpadded concrete foundations over time, they were usually bolted to foundations consisting of timbers or timber footers over concrete. Sharpener foundations are always located in a shop or on a shop platform, are usually 2'x3' in area, and possess four to five anchor bolts.

Forge: Almost every mine shop featured a forge where blacksmiths heated iron. Several types of forges were popular, and most were 3'x3' in area and 2' high. The *gravel-filled rock forge* consisted of dry-laid rock walls, the *wood box forge* had plank walls, and both were filled with gravel. The free-standing *iron pan forge* featured an iron pan supported by iron legs. Companies that required high volumes of work also installed cylindrical and square iron box forges usually 4'x4' in area.

Forge Remnant: Over time, rock- and wood box forges decay, leaving mounds of gravel that often feature anthracite coal, clinker, and forge-cut iron scraps.

Lathe Foundation: Some mechanized shops featured a lathe to facilitate metal- and wood work. Lathes were usually bolted to parallel timbers around 2'x8' in area or less.

Power Hammer Foundation: Mechanized mining companies installed power hammers to expedite metalwork. Many power hammers consisted of obsolete rockdrills bolted to timber posts, and they pounded items clamped to underlying tables. When removed, power hammers can be denoted by a heavy timber post up to 6' high and an adjacent timber stump where the table was located.

Shop Platform: The platform that supported a shop. An artifact assemblage including forge clinker, pieces of hardware, forge-cut iron scraps, cut pipe scraps, and cut wood scraps can help identify a shop platform.

Shop Ruin: The collapsed remains of a shop.

Shop Refuse Dump: A deposit or scatter of forge clinker, forge-cut iron scraps, cut pipe scraps, and pieces of hardware. Carpentry shops left an abundance of cut wood scraps, sawdust, and hardware.

Aerial Tramway Feature Systems

Ore Bin: Top terminals had bins for the input of crude ore onto the system and more bins to receive it at the bottom terminals. The bins were sloped floor types described above with mines.

Ore Bin Platform or Foundation: See mine Property Types above for a description.

Sheave Frame: All tramway types except for single-rope reversible systems had sheave wheels in the terminals for the traction cables. The sheaves were large-diameter iron wheels that spun on axles bolted to stout timber frames. On double-rope and Bleichert systems, the frame encompassed the wheel, while it left clearance around wheels for Hallidie systems. The frames were usually rectangular, cubic, with several layers of stringers tied with vertical posts. Diagonal buttresses braced the frame against horizontal forces.

Terminal Frame: Formally designed terminals had independent frames that supported the building and its components, often separately from the sheave frame. The frames were vernacular in that they were adapted to the conditions, needs, and performance of the system and its integration with the mine. Frames for Bleichert systems had hanging rails for the tram buckets bolted to the ceiling beams. The foundation was of concrete or timbers anchored to bedrock, and may have featured guides to direct the track cables to their anchors.

Terminal Building: The terminal building, usually custom-designed, encompassed the tram mechanism, braking station, and open floor where workers loaded or emptied tram buckets. Buildings were vernacular in construction, adapted to the environment, topography, and location at the mine. Form varied, but materials were usually lumber framing with corrugated sheet iron.

Tension Station: Lengthy Bleichert tramways consisted of multiple segments that operated independently. Tension stations joined the segments and served several functions. They allowed buckets to move uninterrupted from one

segment to another, allowed the overall system to change pitch, and had anchors for the track cables. The stations consisted of timber frames on concrete or rock masonry foundations. Galleries through the structure provided passages for the buckets.

Tension Station Foundation: When dismantled, stations left symmetrical patterns of concrete, rock masonry, and timber footers for the frame. Tram hardware and debris usually lies scattered around.

Tram Tower: Towers supported cables between long spans. For a description of towers, see Section A 1.4.

Tram Tower Platform: Towers usually stood on earthen platforms cut out of a surrounding slope. Platforms for small towers were simple, flat areas while those for large towers may have featured rock retaining walls. Heavy structural materials and tram hardware may lie downslope.

Turning Station Foundation: Turning stations allowed lengthy tramways to curve around obstacles such as mountains. Also known as angle stations, the structures were a union between two independent segments, and in this regard, were similar to tension stations. Turning stations, however, also required the supervision of workers, sometimes to manually switch buckets from one line to another. Thus, turning stations were usually enclosed by a frame superstructure. The stations were custom-designed.

Ore Treatment Mill Feature Types

Mill sites often possess an array of archaeological, engineering, and architectural features that were components of the crushing, concentration, power, and support systems. To help researchers identify components and organize their data, the Feature Types below are arranged according to the general flow path employed at mills.

Ore Treatment Mill Buildings

Assay Shop – Typical Character-Defining Features

Mills usually featured assay shops to track the efficiency of metals recovery and concentration. A metallurgist periodically tested samples of unprocessed crude ore and compared the results with tests on tailings and concentrates. If he found that the metals recovered by the mill approximated the amount in the crude ore, the metallurgist knew the mill functioned efficiently. The assay shop may have been within the overall mill building at small facilities, or provided with its own building at large plants. The shops had distinct appliances such as a free-standing or masonry assay furnace, a blower, a coal bin, and stout workbenches.

Assay shop buildings were usually constructed with the same materials and workmanship as the associated mill. Most were based on lumber frames, had ample windows, a chimney for the furnace, and a heavy subframe or foundation for crushing machinery. The shops were vernacular in that they had no recognized architectural style and were custom-designed for function and economy. A tall, brick chimney; machine foundations; and an artifact assemblage of assay debris are distinguishing characteristics.

- Core Plan: Rectangular, L, or square. Coal bin attached to side.
- Stories: 1 or 1 ½.
- Foundation: Log or timber footers on earthen platform for small buildings, and stone masonry or concrete under large versions. Brick or stone masonry pad for the assay furnace, and anchor bolts for furnace blower.
- Walls: Most were frame construction sided with board-and-batten, planks, or corrugated sheet iron over plank sheathing.
- Roof: Gabled or hipped. Construction was commonly rafters, plank decking, and corrugated sheet iron, plank, or rolled asphalt cladding.
- Chimney: Stovepipe for heating stove. Brick or stone masonry for assay furnace.
- Entry Door: Located in the front and side elevation, doors were factory-made panel units or custom-made of planks.
- Windows: Fixed, sliding, or sash in any of the walls, frames made of 1” or 2” thick milled lumber. May be salvaged from elsewhere.

Mill Building – Typical Character-Defining Features

Mill buildings were distinct in the mining landscape. Most enclosed the ore treatment machinery, power source, and other facilities under one roof. The buildings tended to be large, sloped in profile to conform to staircase terraces or foundations, and irregular in plan.

Each mill was unique, professionally designed, and incorporated elements of both architecture and structural engineering. Most were based on a custom-designed frame that not only supported the walls and roof, but also appliances, bins, and the system of driveshafts and belts that ran the machinery. Given this function, most frames were made of heavy timbers and varied in design and construction. Foundations for small mills consisted of log or timber footers on earth, while stone or concrete sufficed at large plants. Well-designed mill buildings stood independently from interior structures such as bins and stamp batteries, allowing for replacement of the components. Most, however, were tied into the interior structures for economy of materials.

Although mills were professionally designed, they were vernacular in appearance. Prior to the 1910s, board-and-batten siding or walls of layered planks were common, while corrugated sheet iron and tarpaper dominated afterward.

- **Core Plan:** L or complex/irregular. Ore receiving and crushing was at the head, ore processing in the middle, and power source was usually in a lower level extension.
- **Stories:** 1 to 2, descending multiple stairsteps, with vaulted interior.
- **Foundation:** Log or timber footers on earthen platforms for small mills, and stone masonry or concrete under large versions.
- **Walls:** Most were frame construction sided with board-and-batten, planks, or various sheet iron, or rolled asphalt over plank sheathing. The walls may have stood independently of the principal mill frame or tied to the frame and interior structures.
- **Roof:** Gabled or shed at the head, and elongated shed over the main portion. Construction was commonly rafters, plank decking, and corrugated sheet iron, plank, or rolled asphalt cladding.
- **Chimney:** Stovepipes for heating stove and drying furnace. Steel smokestack for boiler.
- **Entry Door:** Located in the top story, side elevations, and lower level, doors were broad and custom-made of planks.
- **Windows:** Fixed, sliding, sash in any of the walls, frames made of 1" or 2" thick milled lumber. May be salvaged from elsewhere. Roof may have featured dormer units.

General Mill Feature Types

Arrastra: An arrastra consisted of a circular stone floor ringed with low sidewalls, and a capstan at center. A draft animal tethered to a harness beam bolted to the capstan walked around the floor, dragging stones chained to the beam.

Arrastra Remnant: Arrastra remnants may retain portions of the floor, sidewalls, and capstan.

Assay Shop Platform: Assay shops often stood on earthen platforms or foundations of concrete and rock masonry. Distinct characteristics can define a platform as that for an assay shop. Foundations or other remnants of an assay furnace, its blower, and small crushers may remain. Artifact assemblages typically include furnace clinker, fire-bricks, broken assay crucibles, mineral samples, and laboratory artifacts.

Cistern: A concrete, masonry, or timber chamber that contained water for mill use. Because mills usually relied on gravity to pressurize plumbing, cisterns tend to be located upslope from a mill.

Conveyor: Mills relied on gravity to draw ore through a sequence of crushing and concentration machinery installed on terraces. Many designs used conveyors to return the ore to the upper terraces for reprocessing, or from one treatment stage to another. Early conveyors consisted of a bucket-line or spiral feed, and later conveyors consisted of belts on rollers. A timber or steel frame was the chassis for the assembly.

Conveyor Remnant: A partially disassembled conveyor.

Ditch: An excavation that carried water to a mill.

Flume: A wooden structure usually constructed with plank walls and a plank floor. Workers built flumes to convey water to or tailings away from a mill and to transfer slurry from one process to another within the mill.

Flume Remnant: The collapsed or buried remnants of a flume.

Machine Foundation: A foundation that anchored an unknown mill machine.

Mill Building Foundation: Mills stood on stout foundations that not only supported the building, but also machinery and structures within. The foundations had footers around the circumference for the walls, and additional footers on the terraces for the frame and machinery. At small mills, the foundations were timbers and logs embedded in earth. At large mills, the foundations consisted of concrete or masonry, and were often integrated with walls retaining the terraces.

Mill Building Ruin: A collapsed mill building.

Mill Platform/Terrace: Because mills relied on gravity to draw the ore through crushing and concentration, they were built over a series of terraces cut out of a slope. Often, the terraces are the principal features representing a mill. Each terrace supported a stage of treatment. When recorded, platforms should be numbered from the top down and described according to function.

Mill Tailings Dump: A deposit of finely ground rock flour and sand usually downslope or downstream from a mill.

Pipeline: An assembly of pipes that carried water.

Pipeline Remnant: The evidence left by a disassembled pipeline.

Privy: See Mine Feature Types.

Privy Pit: The pit that underlay a privy. Privy pits are often less than 5' in diameter and may feature artifacts visible in the walls and floor.

Pump Foundation: Often of concrete, pump foundations are rectangular, less than 2'x4' in area, and may feature pipes.

Receiving Bin: Nearly all mills featured an ore bin at the head to receive crude ore for processing. The bins typically had sloped floors and discharge chutes in the front, which directed the ore into a stamp battery or primary crusher. The walls consisted of a timber frame sided on the interior by heavy planks.

Receiving Bin Platform or Foundation: Receiving bins stood on foundations and platforms similar to those for ore bins at mine sites. Timber or log footers embedded in the ground supported the frame, and cribbing or masonry may have supported the head and toe.

Receiving Bin Ruin: Remnants of receiving bins can be similar to those for ore bins at mine sites.

Refuse Dump: A collection of hardware, structural materials, and other cast-off items.

Reservoir: Some milling operations erected dams in drainages to impound water for use.

Utility Pole: A pole that carried electrical or telephone lines.

Water Tank: A large vessel, usually cylindrical, made of planks or sheet iron. To pressurize plumbing, water tanks were usually located near the head of a mill.

Water Tank Platform: Often a circular or semicircular platform for a tank. The platform's floor may feature a pipe.

Crushing System Feature Types

Jaw Crusher: A jaw crusher reduced crude ore from the receiving bin into gravel, completing the first stage of physical reduction. The heavy machine, also known as a Blake crusher, was located on the mill's upper terrace. Crushers usually featured jaws and dual flywheels powered by a belt. Small units were around 2'x4' in area and large units were up to 4'x8' in area.

Crusher Foundation: Due to severe vibrations, crushers were often anchored to stout timber or masonry foundations with timber footings. Small piles of crushed gravel often underlie crusher foundations.

Stamp Battery: Early mills relied on stamp batteries for primary crushing. After the mid-1880s, batteries often provided secondary crushing, reducing the gravel produced by a jaw crusher. A stamp battery consisted of a heavy timber gallows frame, heavy iron stamps that dropped into a battery box, and a cam shaft that raised and let the stamps fall. The cam rotated in the top of the frame, and it was fitted with a large bullwheel turned by a belt. The stamp shoes were fixed to steel rods that slid in guides. Batteries usually featured stamps in groups of five. The timber frame for a single group tended to be 7' wide, up to 15' high, and stood over a cast-iron battery box bolted to a timber pedestal. Initially, workers shoveled ore into the battery box for crushing, and by the 1890s, automatic feeders introduced the ore.

Stamp Battery Frame: In many cases salvage efforts dismantled the iron hardware from a stamp battery, leaving the timber frame. Bolts for the cam shaft and semicircular guides for the stamp rods are usually evident.

Stamp Battery Pedestal: Often, stamp mills were dismantled for use elsewhere, leaving a pedestal as the principal representation today. Stamp battery pedestals were rectangular, often 2'x5' in area and 2' high, and consisted of timbers set on end. The pedestal anchored a cast-iron battery box in which the stamps crushed the ore.

Screening Station: Successful concentration and amalgamation required the crushed ore to be absolutely uniform in particle size after crushing. Screens in between each crushing stage allowed fine material to proceed while returning coarse particles for reprocessing. Trommels were preferred because they screened ore in a continuous flow. A trommel consisted of wire mesh cylinders nested together and bolted to a steel frame. As they rotated, fine material passed through while coarse particles rolled out and were returned.

Crushing Rolls: A crushing roll was an apparatus that provided secondary or tertiary crushing for ore already reduced to gravel. The apparatus featured a pair of large iron rollers set slightly apart in a cast-iron or heavy timber frame. As they rotated, the rollers drew gravel into the gap and fractured it. Small units were around 4'x4' in area

while common units were 6'x6' in area. Crushing rolls were usually located on an upper mill terrace below the primary crusher.

Crushing Rolls Foundation: Crushing rolls were often anchored to a rectangular timber foundation consisting of heavy, horizontal beams bolted to posts that leaned slightly inward.

Huntington Mill: A Huntington mill was an apparatus that finely ground previously crushed ore, and some were used for amalgamation. The machine was based on a cast-iron pan approximately 6' in diameter and 3' to 4' deep ringed with a channel. A set of heavy iron rollers rotated across the pan floor and ground the ore to a slurry. Fine particles passed through screens breaching the walls and left via the channel.

Huntington Mill Foundation: Huntington mill foundations were factory-made, and the timbers often feature beveled edges. The foundation usually consisted of a rectangular timber footer 6'x9' in area. The machine stood on heavy posts forming a 6'x6' cube at one end, and the other end featured a raised block with a brace for the drive shaft.

Ball Mill: A ball mill was a steel vessel similar to today's cement mixer. The vessel tapered at one or both ends, rotated in heavy bearings, and was powered by a canvas belt and shaft. As the vessel rotated, steel balls inside tumbled and pulverized the ore into a fine slurry. Small units were 4' in diameter and 6' long. Ball mills were used for tertiary crushing in concentration mills and to recover gold with mercury in amalgamation plants.

Ball Mill Foundation: Ball mills were anchored to heavy concrete foundations distinct in footprint. The foundation featured three parallel pylons, usually 1' thick. Two pylons supported the vessel's ends. The one for the narrow end was usually 2' long and 4' high, and the pylon for the broad end was 3' long and slightly lower. The third pylon, often square, stood away and anchored the driveshaft.

Rod Mill: A rod mill operated according to the same principals as a ball mill and saw like applications. The vessel, however, was cylindrical, and steel rods inside ground the ore.

Rod Mill Foundation: Rod mill foundations were similar to those for ball mills. Parallel pylons, usually 1' thick, 3' long, and as high, supported the vessel, and another pylon smaller in size anchored the driveshaft.

Concentration System Feature Types

Amalgamation Table: Amalgamation tables were only used in mills that processed simple gold and silver ores. The tables stood on heavy timber frames and sloped away from the toe of a stamp battery. The tabletops were usually copper, coated with mercury, and around 6'x12' in area. The slurry of pulverized ore produced by the stamp battery trickled over the copper plate, and the mercury caught the gold. In early mills, a flume diverted the spent slurry out of the mill as tailings. Later, the flume delivered the slurry to other amalgamation appliances such as Huntington mills.

Amalgamation Table Frame: Amalgamation tables were usually removed from mills when the facilities were abandoned, leaving a heavy timber frame around 6'x12' in area and at least 4' high.

Jig: A jig was a concentration appliance that enhanced the separation of metalliferous particles from waste. Common jigs consisted of a wood body with a V-shaped bottom that featured drain ports, and wood walls divided the interior into cells. A frame over the cells supported a cam shaft powered by a canvas belt. The shaft gently moved plungers up and down, agitating the slurry in the cells. The action kept light waste in suspension while allowing heavy, metalliferous material to drop out and settle in the V floor. A water current flushed the waste away. Most jigs were around 4'x9' in area and 4' high.

Vanner: A vanner was a concentration apparatus between 4'x8' and 6'x13' in area. The machine featured a broad rubber belt that passed around rollers at both ends of a mobile iron frame. An eccentric cam imparted a vibrating motion that caused heavy, metalliferous particles to settle on the belt. The lighter waste remained on the surface and was washed into a flume by a jet of water. The waste may have flowed out of the mill as tailings, or continued to another set of concentration appliances. Scrapers removed the metalliferous material into another flume for recovery.

Vanner Foundation: Vanners were usually bolted to timber foundations that featured cross-members at both ends, stringers linking the cross-members, and braces for the frame. A flume for the waste slurry usually passed by the vanner's toe.

Vibrating Table: The vibrating table, introduced during the late 1890s, was one of the most successful and widely employed concentration apparatuses. Vibrating tables featured a slanted tabletop, often 5'x15' in area, clad with rubber and narrow wooden riffles. The tabletops were often mounted at a slant on a mobile iron frame oscillated by an eccentric cam. The motion caused heavy, metalliferous material to settle against the riffles while a current of water washed the light waste into an adjacent flume.

Vibrating Table Foundation: Vibrating table foundations featured anchor bolts projecting out of three timber cross-members. Two cross-members were at the ends, and a third was parallel and near one of the ends. The foundations are typically around 12'x15' in length.

Flotation Cells: Introduced during the early 1910s, flotation was a highly successful stage of concentration for complex ore. Flotation cells were based on a large rectangular wooden tank divided into compartments. Paddles agitated a slurry solution in each cell and swept a froth of metalliferous material over the cell's sides. The froth either flowed into a flume or into a second set of cells for additional concentration. A plank walkway often extended along the tank, and the assemblage stood on timbers on one of the mill's lower terraces.

Cyanide Tank: Cyanidation was an alternative to amalgamation for recovering gold from complex ore. Finely ground slurry was introduced into cyanidation tanks, where a dilute cyanide solution leached out the gold. Slowly rotating agitation arms on the tank floor ensured a constant blend. Similar to a water tank, the vessels were usually located on a mill's lowest terrace and provided a last stage of ore treatment.

Settling Tank: Some concentration mills featured settling tanks on the lowest platform where heavy, metalliferous fines gravitated out of spent slurry. Settling tanks were similar to wooden water tanks and often featured a revolving arm at center to exacerbate the settling process.

Mill Power System Feature Types

Boiler: Prior to the 1910s, most mills were powered by steam engines. Return-tube boilers usually generated the steam. See Hardrock Mine Feature Types for a description of boilers.

Boiler Foundation: See Hardrock Mine Feature Types.

Boiler Setting Ruin: See Hardrock Mine Feature Types.

Boiler Clinker Dump: See Hardrock Mine Feature Types.

Motor: See Hardrock Mine Feature Types.

Motor Foundation: See Hardrock Mine Feature Types.

Overhead Driveshaft: Few mill appliances had their own independent power sources, and most were driven by a central engine or motor. Sets of overhead driveshafts and canvas belts transferred motion from the engine or motor to the appliances. Overhead driveshafts, also known as line-shafts, featured belt pulleys over each mill appliance and rotated in bearings bolted to the mill building's frame.

Steam Engine: Prior to the 1910s, steam engines were a common source of power for mills. Usually located on the mill's lowest terrace, the engine transferred motion to a system of overhead driveshafts via a canvas belt. Most engines were horizontal units between 2' and 3' in width and 8' to 12' long. A steam engine required a boiler.

Steam Engine Foundation: Steam engine foundations are often rectangular, studded with anchor bolts, and between 2' and 3' in width and 8' to 12' long. Workers built engine foundations with heavy timbers, brick or rock masonry, or concrete, and the foundations often featured a pylon for the outboard flywheel bearing.

Transformer Station: Those mills with electric power required transformer stations to convert and distribute the current. See Hardrock Mine Feature Types for a description.

Transformer Station Platform: See Hardrock Mine Feature Types.

Transformer Station Ruin: See Hardrock Mine Feature Types.

Smelter Feature Types

The features listed below are an abbreviated list of those expected at smelter sites. Smelters also included many of the same features as concentration mills, which are described in detail above.

Blower: Smelters relied on blowers to force an air blast into a furnace. A typical blower featured a ring of vanes encased in a wood or sheet iron shroud with a port for the outflow. A motor or steam engine powered the blower, and it often stood nearby. Blowers ranged from 3' to 8' in diameter.

Blower Foundation: A foundation that anchored a blower. Foundations were usually rectangular, less than 6'x8' in area, and consisted of masonry, concrete, or timbers.

Coal Bin: Because smelters consumed high volumes of fuel, they almost always featured substantial bins for coal or coke. The bins were usually sloped-floor structures that facilitated a gravity-drawn flow of fuel from the structure.

Coal Bin Ruin: The collapsed remnants of a coal bin.

Coal Bin Foundation: Due to their great weight, coal bins usually stood on masonry or timber foundations. Scatters of coal or coke strongly suggest that a given foundation supported a coal bin.

Furnace: The smelters in the corridor relied on two general types of furnaces, depending on era. The earliest, dating from 1865 until around 1875, was a brick or rock masonry chamber, often with two floors, and ports for air drafts. The interior was lined with fire bricks. The masonry should feature evidence of intense heat and slag. The type of furnace used in later smelters was a free-standing, cylindrical steel vessel lined with fire bricks. These furnaces tended to be from 6' to 20' in diameter and as high. Workers input crushed ore in the top and drew out molten material through ports in the bottom.

Furnace Remnant: The collapsed remnant of a furnace.

Furnace Foundation: The early masonry furnaces stood on rectangular foundations of brick or rock integral with the chamber walls. The free-standing furnaces stood on brick or rock pads larger in footprint than the steel vessel. A foundation for a blower is usually nearby. Furnace foundations almost always feature slag and evidence of heat.

Furnace Platform/Terrace: Furnaces usually stood on dedicated platforms or terraces within the smelter building. Because the furnace provided one of the last stages of ore treatment, the platform was among the lowest at a smelter. Evidence of a furnace, such as slag flows or a foundation, should remain. Free-standing steel furnaces often left little more than the foundation surrounded by slag flows, while masonry types may have left structural ruins.

Slag Dump: Slag is a vitreous waste left after ore was melted and the metal content drawn off. Smelting companies disposed of their slag in dumps downslope from the smelting complex.

Slag Flow: Uncontrolled releases of slag from a furnace created flows on the furnace platform. The flows appear similar to lava or smooth concrete.

Smelter Building: Smelter buildings were similar to those for ore treatment mills. Where possible, they were built over a series of platforms or terraces so gravity could draw the ore through the stages of preparation and smelting. Each terrace was usually dedicated to a specific treatment stage. For a description of the general constitution of the building, see Ore Treatment Mills above.

Smelter Building Foundation: The foundations for smelters were similar to ore treatment mills.

Mining Settlement Feature Types

The settlement Property Types offer a lengthy and diverse array of features, the most common of which are listed below. The researcher should review the entire roster because most Property Types share similar features. Only basic types of residential buildings associated with mines are described below, while those usually in unincorporated settlements and townsites are defined in the section on architecture.

Mining Settlement Building Types

Log Boardinghouse – Typical Character-Defining Features

Mining companies erected boardinghouses for crews of four or more workers. The residents lived in a communal atmosphere, may have shared sleeping quarters, and usually consumed meals prepared in the building. Privies, outdoor work areas, and domestic refuse dumps or scatters are usually associated with boardinghouses.

- Core Plan: Rectangular or L-shaped, two or more rooms.
- Stories: 1, 1½, or 2.
- Foundation: Log or timber footers, or crude stone foundation, on earthen platform.
- Walls: Horizontal logs, round or hewn, assembled with square, V, saddle, or dovetailed joints. Corners may also display “hog trough” construction, with flush sawn log ends nailed to end-plates. Gaps chinked with mud retained by log or lumber strips.
- Roof: Front or side-gabled, with log beams or rafters, plank decking, and sheet metal or shingle cladding. Corrugated sheet iron, rolled asphalt, or asphalt shingles were common by around 1900.

- Chimney: Stovepipe.
- Entry Door: Usually located in the front, with roof extension sheltering the entry. Early doors were made on site of vertical planks, and later were manufactured panel doors. Wooden door frames were made of 1” or 2” thick milled lumber.
- Windows: Square or rectangular, with frames split from hand-hewn logs or made of 1” or 2” thick milled lumber.

Frame Boardinghouse – Typical Character-Defining Features

- Core Plan: Rectangular or L-shaped, two or more rooms.
- Stories: 1, 1½, or 2.
- Foundation: Log or timber footers, or crude stone foundation, on earthen platform.
- Walls: Post-and-girt or balloon frame sided on the exterior with two layers of planks sandwiching tarpaper or newspaper. Board-and-batten siding was common, as well. Planks were used in the interior.
- Roof: Front or side-gabled, with common rafters, plank decking, and sheet metal or shingle cladding. Corrugated sheet iron, rolled asphalt, or asphalt shingles were common around 1900.
- Chimney: Stovepipe.
- Entry Door: Usually located in the front, with roof extension sheltering the entry. Early doors were made on site of vertical planks, and later were manufactured panel doors. Wooden door frames were made of 1” or 2” thick milled lumber.
- Windows: Square or rectangular, with frames split from hand-hewn logs or made of 1” or 2” thick milled lumber.

Log Bunkhouse – Typical Character-Defining Features

Bunkhouses were a type of company housing where workers slept and spent leisure time, but did not regularly prepare food. Instead, they ate in a boardinghouse or company dining hall. Given this, bunkhouses often feature few food-related artifacts relative to the size of the building and the number of inhabitants.

- Core Plan: Rectangular or L-shaped, two or more rooms.
- Stories: 1, 1½, or 2.
- Foundation: Log or timber footers, or crude stone foundation, on earthen platform.
- Walls: Horizontal logs, round or hewn, assembled with square, V, saddle, or dovetailed joints. Corners may also display “hog trough” construction, with flush sawn log ends nailed to end-plates. Gaps chinked with mud retained by log or lumber strips.
- Roof: Front or side-gabled, with log beams or rafters, plank decking, and sheet metal or shingle cladding. Corrugated sheet iron, rolled asphalt, or asphalt shingles were common around 1900.
- Chimney: Stovepipe.
- Entry Door: Usually located in the front, with roof extension sheltering the entry. Early doors were made on site of vertical planks, and later were manufactured panel doors. Wooden door frames were made of 1” or 2” thick milled lumber.
- Windows: Square or rectangular, with frames split from hand-hewn logs or made of 1” or 2” thick milled lumber.

Frame Bunkhouse – Typical Character-Defining Features

- Core Plan: Rectangular or L-shaped, two or more rooms.
- Stories: 1, 1½, or 2.
- Foundation: Log or timber footers, or crude stone foundation, on earthen platform.
- Walls: Post-and-girt or balloon frame sided on the exterior with two layers of planks sandwiching tarpaper or newspaper. Board-and-batten siding was common, as well. Planks were used in the interior.
- Roof: Front or side-gabled, with common rafters, plank decking, and sheet metal or shingle cladding. Corrugated sheet iron, rolled asphalt, or asphalt shingles were common around 1900.
- Chimney: Stovepipe.
- Entry Door: Usually located in the front, with roof extension sheltering the entry. Early doors were Entry Door: Usually located in the front, with roof extension sheltering the entry. Early doors were made on site of vertical planks, and later were manufactured panel doors. Wooden door frames were made of 1” or 2” thick milled lumber.

- Windows: Square or rectangular, with frames split from hand-hewn logs or made of 1” or 2” thick milled lumber.

Single-Pen Log Cabin – Typical Character-Defining Features

A cabin was a self-contained residence for several workers or a family (see Illustration B 1.20). In form, cabins were less than 20’x25’ in area and one-story high. Workers built cabins with any combination of logs, lumber, canvas, and sheet iron. Cabins were vernacular in that the builder adapted conventional form and construction methods to local conditions, available materials, and need. Because cabins were self-contained households, they usually offer a wide array of domestic artifacts. Privies and refuse scatters are often associated.

- Core Plan: Rectangular, one room.
- Stories: 1 or 1½
- Foundation: Log or timber footers, or crude stone foundation, on earthen platform.
- Walls: Horizontal logs, round or hewn, assembled with square, V, saddle, or dovetailed joints. Corners may also display “hog trough” construction, with flush-sawn log ends nailed to end-plates. Gaps chinked with mud retained by log or lumber strips.
- Roof: Front- or side-gabled, with log beams or rafters, plank decking, and sheet metal or shingle cladding. Corrugated sheet iron, rolled asphalt, or asphalt shingles were common by around 1900.
- Chimney: Stovepipe, typically near the rear end of the roof.
- Entry Door: Usually located in the front, with roof extension sheltering the entry. Early doors were made on site of vertical planks, and later were manufactured panel doors. Wooden door frames split from hand-hewn logs or made of 1” or 2” thick milled lumber.
- Windows: Square or rectangular with frames split from hand hewn logs or made of 1” or 2” thick milled lumber.

Double-Pen Log Cabin – Typical Character-Defining Features

A double-pen log cabin was similar to the single-pen type, the principal difference being two rooms instead of open interior. Double-pen cabins were usually rectangular and slightly larger in plan.

- Core Plan: Rectangular, two rooms.
- Stories: 1 or 1½
- Foundation: Log or timber footers, or stone alignment, on earthen platform.
- Walls: Same construction as Single-Pen above.
- Roof: Same construction as Single-Pen above.
- Entry Door: Same construction as Single-Pen above.
- Windows: Same construction as Single-Pen above.

Rectangular Plan Frame Cabin – Typical Character-Defining Features

- Core Plan: Rectangular.
- Stories: 1 or 1½.
- Foundation: Log or timber posts, log footers, or dry-laid stone laid on an earthen platform.
- Walls: Post-and-girt frame, horizontal planks or board-and-batten siding on the exterior, and plank siding on the interior.
- Roof: Front-gabled or side-gabled with wood shingles, rolled asphalt, asphalt shingles, or smooth or corrugated metal, over 1” thick wood decking fastened to wood rafters.
- Chimney: Stovepipe.
- Entry Door: Located either under the gable for front-gable plan, or beneath the eave for side-gable plan. Entries were usually vertical plank doors, and later manufactured panel doors.
- Windows: Vertical sash windows and wood frames made of milled lumber.

Shotgun House (Rectangular Plan Subvariant)

A Shotgun House is a specific design one room wide, two or more rooms deep, and with entry in the gable end (front). Interior hallways are absent, and the rooms are divided by transverse interior walls and doorways. The front room was usually a parlor, with a kitchen to the rear. Other Shotgun House character-defining features are similar to those described above for rectangular plan wood frame dwellings.

Hall-and-Parlor House (Rectangular Plan Subvariant)

A Hall-and-Parlor plan is two rooms wide and one room deep. One room is somewhat larger than the other and typically served as a kitchen and communal living space. The smaller room was a bedroom. Hall-and-Parlor plan houses are covered by side-gable roofs, with the entry door on the side elevation and offset from center. Other character-defining features are similar to those described above for rectangular plan wood frame dwellings.

Privy – Typical Character-Defining Features

A privy was a primitive toilet, consisting of a small building over an open pit. The interior featured a bench seat along one wall with one or two cut-out holes as a toilet seat.

- Core Plan: Rectangular or square.
- Size: 3’x4’ to 5’x8’ in plan.
- Foundation: Log or timber posts, log footers, or corner rocks around open pit.
- Walls: Post-and-girt frame, or corner posts with cross-members, plank or board-and-batten siding on the exterior.
- Roof: Front- or side-gabled, or shed, with plank decking, and rolled asphalt, asphalt shingles, or smooth or corrugated metal. Decking may span the walls or be fastened to wood rafters.
- Entry Door: Entries were usually vertical plank doors, sometimes opening onto a plank deck.

Prospector’s Camp Features

Corral Remnant: Prospectors usually relied on pack animals to carry their goods and penned the animals in informal corrals near their camps. The corral boundaries maximized natural obstructions, and had fences of branches, stumps, and wire.

Dugout: A dugout was among the most impermanent and primitive forms of residence. They were created by prospectors who lacked wall tents but were unwilling to invest time and resources in superior accommodations. A dugout consisted of an excavation in a slope, 8’x10’ or larger in area, roofed with logs or branches covered with earth. The front often had a log or rock masonry façade, a window, and doorway. A chimney or stovepipe extended out the roof. Dugouts were not limited to residential use, and the design served other purposes. Root cellars, hay storage, and explosive magazines appear similar to dugouts. To recognize a resource as a dugout, it should be center to an assemblage of domestic refuse, which reflects inhabitation.

Dugout Ruin: Dugouts usually collapsed when abandoned. Ruins manifest as ovoid depressions embedded with structural materials. A sparse artifact assemblage of domestic refuse should be present.

Fire Hearth: Prospectors often built large outdoor rings or rock structures for cooking and heating fires. The ring should be near the tent or cabin platform and exhibit signs of aging such as collapse and revegetation.

Pack Trail: Pack trails often radiated outward from prospectors’ camps to the areas under examination and to the nearest commercial centers. Most were created by foot and pack-animal traffic, and others were intentionally graded to fulfill claim assessment requirements. Pack trails are no wider than 8’.

Tent Platform: Prospectors often graded small platforms, usually less than 20’x20’ in area, for wall tents. In some cases, prospectors placed rocks on the platform’s edges or corners to support a tent’s wood pallet floor and drove stakes along the edges to guy the walls. A paucity of structural artifacts, the presence of tarpaper washers, and disbursed domestic artifacts characterize tent platforms.

Workers’ Housing Features

Boardinghouse Platform: Boardinghouses usually stood on earthen platforms, which may feature rock or log footers and a collapsed root cellar. The platform often represents the building’s size and footprint.

Boardinghouse Ruin: The structural remnants of a boardinghouse.

Bunkhouse Platform: A platform where a bunkhouse stood. The platform should feature few food-related artifacts, and the platform usually represents the structure’s size and footprint.

Bunkhouse Ruin: The structural remnants of a bunkhouse.

Cabin Ruin: The collapsed remains of a cabin.

Cellar Pit: Cellars, mistaken for dugout residences, were subterranean structures that provided cold storage for perishable food. They usually had plank walls retaining an earthen pit, a plank or log roof covered with earth, and a sunken doorway. In some cases, cellars were underneath cabins and boardinghouses. When the walls and roof

collapsed, the cellars tend to manifest as pits with notches marking the entry. A lack of domestic refuse is a common attribute.

Chimney Remnant: A collapsed chimney, usually consisting of rocks or bricks. Chimneys are usually components of building platforms.

Cistern: Organized, well-capitalized residential complexes occasionally included cisterns for fresh water. Cisterns were plank, concrete, or stone masonry chambers sunk into the ground, usually with inlet and outflow pipes.

Corral: Pack animals provided transportation in the mining industry before 1940, when automobiles became common. Company housing complexes, unincorporated settlements, and towns almost always had corrals to impound multiple animals. The corrals varied widely in size, plan, and constitution, depending on the number of animals and type of impoundment operation. Livery businesses tended to build large corrals geometric in plan with wooden or wire fences, feed troughs, and stables. Mining companies, on the other hand, built smaller corrals that utilized natural features as barriers to save construction costs. Such corrals were built in open areas bordered by streams, rock outcrops, thickets, and slope changes, and incorporated combinations of branches, upended stumps, and wire as fencing.

Corral Remnant: After abandonment, corrals may feature evidence of their boundaries such as wires, branches, upended stumps, individual fence posts, and cobble alignments marking a fence line. The interior should either be open or feature vegetation younger than in the surrounding area.

Developed Spring: Settlements depended on water for existence, and residents were able to subsist on surface sources when a community was still in its early stages of growth. Springs were preferred because of their purity. When water was difficult to collect, the residents developed the spring by excavating a chamber, lining it with planks or masonry, and diverting drainage around the excavation.

Domestic Refuse Dump: People usually threw their solid refuse downslope from their residences, forming deposits of domestic artifacts. Large deposits that were high in volume qualify as dumps. Artifacts are usually domestic in nature, primarily food-related, and include food cans, fragmented bottles and tableware, and personal articles.

Domestic Refuse Scatter: A refuse scatter is a light amount of domestic artifacts disbursed over a broad area. Domestic scatters usually extend downslope from a residential feature.

Privy Pit: Privy pits were excavated in the ground underneath privies to receive waste. When a pit became full, the residents relocated the privy building, topped the depression off with domestic refuse, and shoveled over a soil cap. The cap subsided as the pit contents leached away and decayed, creating a depression usually less than 6' in diameter. Pits often feature backdirt downslope, some domestic refuse in the interior, and ashy soil. The pit may be surrounded by more refuse and footers for the privy building.

Residential Building: Settlement sites may feature buildings that material evidence defines as residential, but the buildings do not clearly possess the characteristics of boardinghouses, bunkhouses, or small cabins. Such buildings can be recorded as general residences.

Residential Building Platform: A platform, confirmed by artifacts, which supported an unspecified residential building.

Residential Building Ruin: The structural remnants of a residential building.

Road: Residential complexes usually required roads to accommodate traffic. Roads are at least 8' wide.

Root Cellar: Residences and businesses that handled high volumes of perishable food had root cellars for storage. Such enterprises were commonly boardinghouses, restaurants, hotels, and markets. Root cellars, often mistaken for dugouts, were excavated near their associated buildings. Walls usually made of rocks, logs, or lumber retained the earthen sides and a roof covered with more earth. Because root cellars were not residences, they usually offer few domestic artifacts and lack stovepipe ports.

Spring Box: A spring box was a small enclosure built over a developed spring. The structures had plank walls, often a masonry or concrete chamber, a roof, and an entry door.

Stable Ruin: A collapsed stable.

Well: Because many settlements lacked reliable and clean sources of water, residents turned to wells. Three types were common in mining districts. The earliest was a hand-dug shaft lined with dry-laid masonry and crowned by a platform at the collar. Once hardware was available, residents sank pipes into the ground and fitted them with hand-pumps. In some cases, communities or mining companies installed steam- or gasoline-powered pumping stations over large-diameter wells.

Townsite and Unincorporated Settlement Features

Townsites and unincorporated settlements usually included some of the same features described above with Workers' Housing. Common building types are described in the section on architecture.

Assay Shop: See Ore Treatment Mill Feature Types.

Assay Shop Foundation/Platform: Assay shops often stood on earthen platforms or foundations of concrete and rock masonry. Distinct characteristics can define a platform as that for an assay shop. Foundations or other remnants of an assay furnace, its blower, and small crushers may remain. Artifact assemblages typically include furnace clinker, fire-bricks, broken assay crucibles, mineral samples, and laboratory artifacts.

Blacksmith Shop: See building types above.

Blacksmith Shop Platform: Blacksmith shops usually stood on earthen platforms larger than the building for storage of materials and large items. Rock alignments and deposits of forge clinker usually define the building's footprint. The artifact assemblage is distinct and includes much forge clinker, forge-cut iron scraps, hardware, and sheet iron.

Blacksmith Shop Ruin: The collapsed remnants of a blacksmith shop.

Commercial Building: See section on architecture.

Commercial Building Foundation/Platform: Primitive commercial buildings stood on logs or rocks laid on earthen platforms. Large buildings may have stood on formal foundations of masonry or concrete. Artifacts and buried archaeological deposits are often few because most service and retail businesses generated little refuse.

Commercial Building Ruin: The collapsed remnants of a commercial building.

Ditch: Many unincorporated settlements and towns featured ditches that delivered fresh water for consumption and other uses. The ditch, the most primitive public utility, tapped the nearest reliable source and carried the water through the settlement.

Hotel: See Section B 8.

Hotel Foundation/Platform: Small hotels stood on rock alignments and logs laid on earthen platforms, while larger hotels may have had formal masonry or concrete foundations. The platforms tend to be large and may feature a cellar pit if the hotel had a kitchen. The artifact assemblages are often distinct and can include a high proportion of small personal items, clothing, hardware, decorative domestic wares, furniture parts, and lamp parts. Large and numerous privy pits are often associated.

Livery: A livery was a business that temporarily boarded draft animals. Defining characteristics include corrals, collapsed fences, evidence of stables, earth packed by animal traffic, and manure deposits. Because of noisome pests and odors, liveries were usually located on the fringes of a settlement. The artifact assemblage should include a high proportion of tack straps and hardware.

Restaurant: See section on architecture.

Restaurant Foundation/Platform: Restaurant platforms are similar to those for commercial buildings, except they almost always offer large quantities of food cans, fragmented tableware and bottles, butchered bones, and kitchen implements.

Saloon: See Section B 8.

Saloon Foundation/Platform: Saloons stood on platforms similar to those for commercial buildings. The artifact assemblage is distinct and includes high proportions of fragmented bottles relative to other items.

Section B 2: Timber Industry Property Types and Registration Requirements

This section lists types of historic resources common to the timber industry in the I-70 corridor and provides their registration requirements. The Property Types are categorized according to the industry's two principal facets: lumber milling and railroad tie production. Itemized descriptions of archaeological, structural, and architectural features are offered at the section's end to refine historic resource interpretation. All the Property Types except for Single Residence logging camps required wagon service, and thus included road segments. To describe and evaluate contributing segments, consult Appendix VI in *National Register Bulletin 16A: How to Complete the National Register Registration Form*, available at History Colorado and the National Park Service.⁶⁷⁹

The following Property Types and Subtypes are developed in this section:

- Sawmill Site
- Logging Camp
 - Single Residence
 - Multiple Residence
- Loading Station
- Tie Collection Point
- Flume
- Rural Historic Timber Industry Landscape

PROPERTY TYPE: SAWMILL SITE

Sawmills were industrial complexes of buildings and engineered structures where workers reduced raw logs into lumber. Individuals and partnerships ran small mills, while organized companies operated larger facilities. Overall, the process of converting logs to lumber was uniform throughout the West. It began when teamsters delivered raw logs via wagon or mule to a stockpile slightly upslope from the sawmill. Flumes may have delivered logs to large facilities, and after the 1910s, lumber companies increasingly used trucks. Workers inspected the stockpiled logs, staged them on either a loading frame or earthen platform, and rolled them down to the sawmill one by one as needed.

The sawmill itself consisted of engineered structures often, but not always, enclosed under a roof (see Illustrations B 2.1 and B 2.2). The dominant aspect was a timber structure known as a saw-frame, 30' to 100' in length, 3' to 6' wide, as high, on which logs were reduced into lumber. Two radial saws near center cut the lumber lengthwise and crosswise. Workers fastened one log at a time to a dolly on rails, winching it along the frame and into the saw blades. As the dolly moved back and forth, the saws first cut away rinds of bark, followed by slicing lumber pieces to specification. Prior to around 1920, a steam engine usually powered the saw blades, and it and boiler were bolted to a stout foundation adjacent to the blades. After 1920, lumber outfits increasingly employed gasoline engines. A simple building open on one or more sides usually enclosed the saw blades and engine, as well as all or part of the saw-frame.

⁶⁷⁹ *National Register Bulletin 16A: How to Complete the National Register Registration Form*. National Park Service, 1997 [1977].

Finished product left the frame on rollers or another dolly, and workers stacked it for shipment to market. They also collected the discard rinds known as mill slabs, piling them in stacks. Because sawmills had to be moved when a stand of timber had been cut over, their components were portable. As a result, the large frame, engines, boiler, and other pieces of equipment were designed for disassembly.

Because lumber production methods and equipment were universal, sawmill form and configuration tended to follow the general template outlined above. Although most sawmills incorporated factory-made machinery, each was vernacular in engineering and construction. Vernacular sawmills were custom-designed, usually by the lumber company, to function in a specific environment or place while meeting needs of the operation. The company built the plant with a combination of factory-made and forged hardware, purchased lumber, locally harvested logs, and lumber previously cut by the company. Workers then assembled the materials according to their interpretation of general sawmill template. When adapting the template, they considered operation size, immediate environment, and available capital. Their construction skills, experience, and traditions of building and engineering were influential factors, as well.

Most saw complexes included buildings, and, like the sawmill itself, were almost always vernacular. Workers maintained tools and manufactured hardware in blacksmith shops, stored materials in sheds, and lived in cabins or boardinghouses. Lumber companies also kept draft animals, always present, in stables. Architects or engineers rarely designed and constructed the buildings, which were instead familiar forms that workers adapted to company needs, budget, and the surrounding environment. Workers assembled the buildings with materials available at the sawmill complex, primarily raw logs and lumber cut by the company. The buildings were also expressions of workers' techniques, methods, and cultural backgrounds.

In addition to buildings and the sawmill itself, complexes usually included aspects of primitive infrastructure that supported the workers and associated logging operation. Ditches and pipelines provided water for workers and steam equipment, while flumes may have delivered raw logs or carried lumber away. Transportation systems included networks of skid trails to logged areas, and roads for freighting finished products to market. As with the sawmill proper, these aspects of infrastructure were rarely professionally designed and instead evolved organically in response to need.

Most sawmills in the I-70 corridor were dismantled when they ended service, leaving few intact at present. As a result, those sites left today tend to be represented primarily by archaeological evidence. Timber bolsters and log cribbing may denote the log staging area, foundation footers and impressions left by timbers reflect the saw-frame, and debris and earthen platforms depict building locations. Sawmills also left distinct forms of refuse such as hardware, sawdust dumps, and stacks of mill slabs. Most sites may exhibit poor physical integrity because they operated in harsh environments challenging preservation of features and artifacts. Revegetation, the accumulation of forest duff, and soil creep often obscure surface features. Moisture, organic soil, and duff conceal artifacts and disintegrate perishable items. Thus, sites retaining high degrees of archaeological integrity are uncommon.

Sawmill Site Significance

As historic resources, sawmill sites participated in and were associated with a variety of Areas of Significance, including: Commerce, Community Planning and Development, Economics, Engineering, Exploration/Settlement, Industry, and Politics/Government.

The Period 1860 to 1920 encompasses the timber industry in the I-70 corridor. But the industry's history was not uniform throughout, with narrower timeframes of importance applicable to specific regions when assessing resource significance. The regions and their Periods of Significance are: 1860 to 1920 in Clear Creek drainage, 1879 through 1912 in Summit County, and 1886 to 1920 along the Eagle and Colorado rivers. Some, if not all, Areas of Significance below are applicable to lumber operations during these timeframes. Level of significance was local, but could be statewide for sawmills that produced and shipped high volumes of lumber to distant markets, depending on further research.

Area of Significance: Commerce: The timber industry and its sawmills were significant in *Commerce* on a local level. The industry converted natural resources into a commodity sold in local markets. The commodity, lumber, was vital for industrial, residential, and commercial development. Further, its production, transportation, and sales supported local economies and systems for trading and distributing goods. Highly productive lumber companies shipped product outside of their operating regions, contributing to statewide commercial systems. Some companies in Clear Creek drainage sent lumber to Denver; outfits in Summit County sold product in Leadville and the Robinson district; and sawmills in Eagle County supplied Leadville, Red Cliff, and Aspen. The lumber exports, and importation of goods and equipment in return, fostered a regional economy, and wed the timber industry with mining, railroads, and urban centers.

Area of Significance: Community Planning and Development: Lumber produced by sawmills was the material basis for the construction of local communities. By producing lumber, the industry allowed settlements to evolve from collections of crude log cabins into elaborate frame buildings. Using dimension lumber and machined trim, building owners were able to express building function, socioeconomic status, cultural preferences, and climatic adaptations. Collectively, the industry impacted development patterns.

Areas of Significance: Economics: The timber industry was significant in *Economics*, converting natural resources into a cash product and diverting a large portion of the money into local economies. Lumber companies paid wages to workers, hired contractors for services, and purchased items in nearby towns. The lumber produced and consumed locally also contributed. Overall, the timber industry had a significant local impact. On a broader level, lumber companies contributed to complex regional economic systems. In selling product to distant markets, notably Denver; Leadville, and other mining towns, companies brought wealth from distant communities into the I-70 corridor. Companies acquired large machinery and other industrial goods from manufacturers mostly in Denver, and to a lesser degree from outside of Colorado. The manufacturers in Denver in turn purchased their materials from sources within and outside of Colorado. Finally, hundreds of lumber company workers consumed food and other domestic goods purchased from a variety of sources. Preserved food was shipped from packing companies in the Midwest and on the West Coast, while fresh foods came from Colorado farms and ranches.

In consuming foodstuffs, the employees not only supported a complex food transportation network, but also facilitated development of farming and ranching.

Area of Significance: Engineering: When erecting large sawmills, logging outfits adapted lumber production technology and engineering to primitive environmental conditions including difficult terrain, inaccessibility, and an undeveloped landscape. In so doing, the outfits contributed to the evolution of vernacular engineering specific to lumber production. Overall sawmill design, arrangement of components, preferred machinery, and process for converting trees into lumber became a template that the timber industry implemented for decades. Except for driven engines and heavy equipment to move logs, sawmills changed little in design and operation from the Period of Significance through the 1950s.

Area of Significance: Exploration/Settlement: Sawmills embody *Exploration/Settlement* in three principal ways, primarily at a local level of significance. The first applies to the remote reaches of Clear Creek drainage during the 1860s and the Eagle and Colorado rivers during the 1880s. In these regions, sawmills and their camps were among the earliest Euro-American outposts. From these bases, loggers explored areas overlooked by prospectors, homesteaders, and ranchers, contributing to a growing knowledge of regional geography.

Second, sawmills influenced settlement patterns in remote portions of Clear Creek drainage, Ten Mile Canyon, the Dillon area, and the Eagle and Colorado river valleys. Sawmills provided the reason why some organized hamlets existed. Several of these, including Bakerville and Fisk's Station near the head of Clear Creek, would have dissolved were they not sawmill centers. With the support of logging, the hamlets were able to fulfill other roles such as commercial, communications, and transportation centers. Sawmills were also a mechanism for widespread rural settlement in areas unsuitable for agriculture and mining. Mill workers and loggers lived in crude cabins and boardinghouses scattered throughout the region's forests.

Third, sawmills directly supported many principal settlements in the corridor. Although the towns were not entirely dependent on logging, sawmills complemented other industrial and economic sectors, contributing to local economies and employing town residents. This helped stabilize the principal settlements and allow them to become permanent.

Area of Significance: Industry: Sawmills were important in the Area of *Industry* in several ways. First, sawmills were a key component of the timber industry, which provided the physical materials that literally built the I-70 corridor's mining industry, railroads, infrastructure, and all the settlements. Sawmills were also important employers, economic contributors, and mechanisms for settlement of remote areas. Second, large sawmills produced lumber for Denver, mountain communities outside the corridor, and their industries and infrastructure. In so doing, the large mills contributed to development, growth, and settlement in these regions.

Area of Significance: Politics/Government: Sawmills were instruments through which lumber companies exhausted forests on public lands, encouraging federal regulation of logging. Prior to passage of the Forest Reserve Act in 1891, commercial logging was largely unregulated because the federal government provided no clear structure for the industry. The Forest Reserve Act allowed designation of forest reserves and controlled logging within reserve boundaries. But the government neglected to enforce the act due to a lack of support and insufficient funding for

responsible agencies, such as the General Land Office and Department of the Interior. In the I-70 corridor, destruction of entire forests became so blatant that Colorado state and federal foresters responded during the 1890s. They enforced the act's regulations by shutting down sawmills and requiring lumber companies to follow a permitting process. The Roosevelt administration created the Forest Service in 1905, designating the Arapahoe, Roosevelt, and White River National Forests.

Sawmill Site Registration Requirements

To qualify for the NRHP, sawmill sites must meet at least one of the Criteria listed below and possess adequate physical integrity to convey their significance.

Criterion A: Resources eligible under Criterion A must be associated with at least one Area of Significance noted above as well as a contribution to a broad pattern of history.

Criterion B: Sawmills may be eligible under Criterion B provided an association with the life of an important person significant in our past. Presence will most likely be through residence, employment, or other involvement with the logging operation. The associated resource must retain physical integrity relative to that person's productive life. A brief biography is necessary to detail the individual's significant contributions. In some cases, important people invested in lumber operations or owned sawmills but did not occupy the property. Such an association does not meet the registration requirements outlined here. The individual of note must have been present on-site. In general, applying Criterion B is complex, and *National Register Bulletin 32: Guidelines for Evaluating and Documenting Properties Associated with Significant Persons* can provide further guidance.

Criterion C: Sawmill sites may be eligible under Criterion C when they clearly exemplify a sawmill operation and possess integrity relative to one of the Periods of Significance. Because most equipment and buildings were removed when a sawmill was abandoned, archaeological features and artifacts usually represent the operation. A site retains sufficient integrity on an archaeological level when the material evidence clearly conveys the overall complex's organization pattern, design, support facilities, and historical operations. Intact buildings, structures, and machinery are rare, and thus may be important examples of engineering, technology, and architecture specific to lumber production. Some of these attributes may also reflect adaptation to the environment high elevation. Character-defining features should be evident, even if on an archaeological level. The log staging area, remnants of the saw-frame, power source, associated buildings, waste disposal area, or other facilities should be discernible. Sawmill sites may be eligible as contributing elements of a historic logging landscape.

Criterion D: Sawmill sites may be eligible under Criterion D if they hold a high likelihood of yielding important information upon further study. Buried archaeological deposits are a common source of information, often manifesting as privy pits, layered materials around building platforms, and thick sawdust dumps. Deposits may include artifacts capable of enhancing our current understanding of workplace behavior, diet, and substance abuse. If workers lived on-site, residential deposits may illuminate the currently dim portrait of loggers and their lifestyle.

If a site possesses structures and buildings, detailed examination may reveal how lumber companies adapted architecture and engineering to meet their needs in difficult high-altitude conditions. Process and infrastructure systems often lend themselves to detailed studies, and examples include sawing logs into lumber, powering the sawmill, and delivering water.

Eligible sawmill sites must possess physical integrity relative to one of the Periods of Significance outlined above. Because most small sawmills possessed few structures and little machinery, usually salvaged when a site was abandoned, integrity may be on an archaeological level. Larger sawmill sites may still exhibit intact buildings or engineered structures. Material evidence should ideally permit the virtual reconstruction of the operation. Common features encountered at sawmill complexes are noted at the Section's end.

Most of the seven aspects of historic integrity defined by the NRHP apply to sawmill sites, although not all need be present. Intact buildings, structures, and machinery must be in their original places of use to retain integrity of *location*. For a resource to retain integrity of *design*, the sawmill's material remains, including archaeological features, must convey the facility's organization, planning, and engineering. To retain *setting*, the area around the sawmill, and the resource itself, must not have changed a great degree from its timeframe of significance. If the resource is isolated, then the natural landscape and areas of stumpage should be extant. If the resource lies in a larger landscape, then the surrounding mines and industrial features should retain at least archaeological integrity. In terms of *feeling*, the resource should convey the sense or perception of historic logging operations. Integrity of *association* exists where structures, machinery, and archaeological features convey a sense of connectedness between logging and a contemporary observer's ability to discern the historic sawmill operation.

PROPERTY TYPE: LOGGING CAMP

Logging camps were residential centers for a timber industry workforce made up of loggers, builders, muleskinners, blacksmiths, cooks, and hostlers. Small, simple camps provided a few workers with housing and meals, while substantial complexes were also base camps with facilities to support logging itself. Regardless of size, most camps included a blacksmith shop and stables for draft animals. Lumber companies and tie contractors established camps near their points of work deep in the forest, too far from a sawmill or settlement for a reasonable commute by foot.

A historic resource can qualify as a logging camp if it meets certain conditions. First, the principal function must be workers' housing. Logging camps were residential complexes independent from industrial facilities such as sawmills. This can be confirmed by cabin and boardinghouse features, domestic artifacts, and absence of major industrial aspects. Second, the resource should be proximal to an area of stumpage, thereby enforcing integrity of setting feeling, and association. Last, the resource should possess physical characteristics of single-residence or multiple residence camps described below.

Logging Camp Subtypes

Single Residence Logging Camp: Single-residence camps had one residential building for a small team of loggers, and simple facilities to support them in their immediate work. Loggers preferred to site their camps in the forest where they worked, but were willing to commute short

distances if a stream was available nearby. Camps remained primitive because loggers occupied them on a temporary basis, just long enough to cut over the surrounding forest.

The residence was usually little more than a primitive vernacular cabin. In general, the cabins were designed by loggers in the field to meet their daily domestic needs. The loggers relied on their knowledge of building form and construction to complete functional cabins at minimal cost. Most cabins were square or rectangular, single- or double-pen in plan, and less than 25'x30' in plan. Workers usually constructed the building with locally harvested logs on a cut-and-fill platform for the floor. They assembled the walls with saddle, square, V, or dovetail joints, and chinked gaps between the logs with mud retained by log or lumber strips. The loggers then laid one or more ridge-beams across the walls to support a roof of split logs, lumber, or shingles. This general pattern changed little from the 1870s through the 1910s. During the 1860s, dry-laid rock foundations and stone fireplaces were common.

Although the residence was a core feature, the camps also had several support facilities. A stable and corral were the most common because loggers almost always relied on draft animals to haul their products to a sawmill or shipping point. The stables were usually constructed with similar materials and workmanship as the cabins, except that they lacked windows and had wide doorways. Corrals varied in plan and were arranged on unaltered ground near the stable. Instead of erecting formal fences to bound the corral, loggers gathered materials such as downed branches and logs as barriers, and incorporated features such as stumps, rock outcrops, and stands of brush.

A blacksmith shop was another common facility, allowing loggers to sharpen tools and manufacture light hardware. Basic appliances included a forge and blower, anvil, and workbench. Where logging operations were intensive, workers may have erected a dedicated building for the shop, although they usually arranged the appliances under a shed roof or canvas awning adjacent to the cabin.

In camp, loggers attended to the basic necessities of life, and those resources existing today usually offer evidence of this. Artifact assemblages almost always have a high proportion of food-related items. Cans are common as loggers relied on preserved food and had little time for elaborate meals or access to fresh ingredients. Other domestic items are few because of the austerity and simplicity of logging camp lifestyles. What might be found includes clothing hardware, tableware fragments, stove parts, and tools.

Waste disposal at single-residence camps was primitive. Privies served as toilets, standing over shallow pits various distances from the cabin. Household refuse was usually thrown downslope from the cabin and accumulated in the forms of scatters and dumps.

Although single-residence camps are associated with lumber operations, the camps also tend to be strongly associated with railroad tie production. Lumber company employees often lived and worked in crews, while most tie hacks were independent contractors usually working in pairs.⁶⁸⁰ A party of several hacks needed little more than a single cabin and a stable. Specific physical evidence may identify a given camp as that for tie hacks. Unfinished ties may be scattered around, with stumps in the area ranging from 10" to 15" in diameter, the preferred size for railroad ties.⁶⁸¹

Because camps were occupied briefly and their buildings poorly assembled, structural elements often collapse after abandonment. Thus, many camp sites may manifest as

⁶⁸⁰ Reich, William L. *Colorado Industries of the Past*. Boulder, CO: Johnson Books, 2008, 175.

⁶⁸¹ Wroten, William H. *The Railroad Tie Industry in the Central Rocky Mountain Region, 1867-1900*. University of Colorado, 1956, 243; Reich, 2008:175.

archaeological sites. Standing cabins and stables are rare and significant representatives of logging camp architecture.

Multiple-Residence Logging Camp: Multiple-residence camps were lumber company outposts for intensive logging operations too far from a sawmill or settlement for commute by foot. The camps featured two or more residential buildings and industrial facilities that supported logging operations. Although some tie contractors employed crews large enough to justify multiple-residence camps, most were associated with lumber companies. To confirm whether a camp belonged to a lumber company, stumps in the area should be greater than 15” in diameter, a size preferred for lumber.

The residences ranged from primitive cabins to bunk- and boardinghouses, vernacular in design. Although logs were the favored building material, capitalized lumber companies used frame construction in the larger camps. The difference between a bunkhouse and boardinghouse was meal service. Although both buildings were intended to house multiple workers, meals were prepared and eaten in boardinghouses while workers merely slept and spent leisure time in bunkhouses. Boardinghouses thus featured kitchens, large cook stoves, and voluminous refuse dumps. Bunkhouses, in contrast, had smaller proportions of domestic rubbish relative to the building size. As a living environment, the camps were unimproved and rough because they were intended to be temporary and occupied only long enough to cut over the surrounding forest.

In addition to residences, the camps almost always had support facilities for the logging operation. Several stables and a corral were common because lumber companies required draft animals to haul products to the sawmill or a loading station. Stables were usually constructed with logs, lacked windows, and had doorways at least 36” wide. Corrals tended to be constructed with the same materials and workmanship as at single residence camps, and located on unaltered ground by the stable. A blacksmith shop was an important facility, and in it, a company blacksmith sharpened tools and manufactured light hardware. The shop was often in a dedicated wall-tent or building constructed with similar materials and workmanship as the camp’s others. Inside were basic appliances including a forge and blower, anvil, and workbench. Where production was high, camps had loading stations where loggers stockpiled logs to transfer them onto wagons. The station, described below as a separate resource type, consisted of a clearing for the stockpile and elevated frames for rolling logs onto wagons.

In the camp, lumber companies provided for workers’ basic necessities, and those sites existing today offer evidence of this. Meals were a focus of the logger’s day, and artifact assemblages at camp sites almost always exhibit high proportions of food-related items. Although cans are common, companies also served meals based on fresh ingredients such as butchered meat. To store foodstuffs, the company may have constructed an independent a root cellar near the boardinghouse, or excavated a cellar pit underneath the boardinghouse kitchen. General domestic items are usually few because of the austerity and simplicity of camp life. Waste disposal at multiple-residence camps was primitive but somewhat organized. Privies tended to stand over deep pits away from the residences. Household refuse was usually thrown downslope and away from the residences, where it accumulated in the form of a distinct dump.

Logging Camp Significance

Logging camps were associated with Areas of Significance including Architecture, Commerce, Economics, Exploration/Settlement, and Industry. The applicability of each Area differs slightly for camps associated with lumber production or tie cutting in cases when they can be distinguished in the field.

Period of Significance must be considered when assessing logging camps. The Period 1860 to 1920 covers the timber industry throughout the I-70 corridor, but the industry's history was not uniform in all sub-regions. Narrower timeframes may be more applicable geographically: 1860 to 1920 in Clear Creek drainage; 1879 through 1912 in Summit County; and 1886 to 1920 along the Eagle and Colorado rivers. Level of significance was local, but could be statewide for large camps associated with production and shipment of lumber in volume, depending on further research.

Area of Significance: Architecture: Standing buildings in logging camps are significant in the Area of Architecture. Logging companies, and individual workers, adapted conventional design and construction to the physical environment and materials available in the corridor's forests. Most buildings were vernacular, influenced by the builder's financial resources, needs, skills, and experience.

Area of Significance: Commerce: The timber industry and its camps were significant in *Commerce*, converting natural resources into a commodity sold in local markets. The commodity, lumber and railroad ties, was vital for industrial, residential, and commercial development. Further, its production, transportation, and sales supported local economies and systems for trading and distributing goods. Highly productive lumber companies shipped product outside of their operating regions, contributing to broader commercial systems. Some companies in Clear Creek drainage sent lumber to Denver; outfits in Summit County sold product in Leadville and the Robinson district; and sawmills in Eagle County supplied Leadville, Red Cliff, and Aspen. The lumber exports, and importation of goods and equipment in return, fostered a regional economy, and wed the timber industry with mining, railroads, and urban centers.

Areas of Significance: Economics: The timber industry, made possible through camps, was significant in *Economics*. When the industry converted natural resources into a cash product, it diverted a large portion of the money into local economies. Lumber and railroad companies paid wages to workers, hired contractors for services, and purchased items in nearby towns. The lumber and ties produced and consumed locally also contributed. Overall, the timber industry had a significant local impact. On a broader level, lumber companies contributed to complex regional economic systems. In selling product to distant markets, notably Denver; Leadville, and other mining towns, companies brought wealth from distant communities into the I-70 corridor. Companies acquired large machinery and other industrial goods from manufacturers mostly in Denver, and to a lesser degree from outside of Colorado. The manufacturers in Denver in turn purchased their materials from sources within and outside of Colorado. Finally, hundreds of lumber company workers consumed food and other domestic goods purchased from a variety of sources. Preserved food was shipped from packing companies in the Midwest and on the West Coast, while fresh foods came from Colorado farms and ranches. In consuming foodstuffs, the employees not only supported a complex food transportation network, but also facilitated

development of farming and ranching. The movement of wealth was a function of railroads, literally built upon ties produced by the timber industry.

Area of Significance: Exploration/Settlement: Sawmills embody *Exploration/Settlement* in three principal ways, primarily at a local level of significance. The first applies to the remote reaches of Clear Creek drainage during the 1860s and the Eagle and Colorado rivers during the 1880s. In these regions, sawmills and their camps were among the earliest Euro-American outposts. From these bases, loggers explored areas overlooked by prospectors, homesteaders, and ranchers, contributing to a growing knowledge of regional geography. Second, logging camps in themselves were a form of disbursed, rural settlement. Lumber workers and tie hacks lived in hundreds of crude cabins and boardinghouses scattered throughout Clear Creek drainage, Summit County, and the Eagle and Colorado river valleys.

Third, camps made possible the timber industry, which directly supported many principal settlements in the corridor. Logging complemented other industrial and economic sectors, contributing to local economies and employing town residents. This helped stabilize the principal settlements and allow them to become permanent.

Area of Significance: Industry: Logging camps were important in the Area of *Industry* in several ways. In general, the camps were a key component of the timber industry by housing its workforce. The industry provided the physical materials that literally built the I-70 corridor's mining industry, railroads, infrastructure, and all the settlements. The camps also participated heavily in employment, economic contributions, and settlement of remote areas.

Some camps associated with large-scale lumber operations were significant for housing workforces that produced lumber not only for the corridor, but also other mountain communities, Denver, and their industries and infrastructure. In so doing, the camps contributed to development, growth, and settlement in elsewhere in the region.

Railroad tie camps in the Blue River and Ten Mile Canyon area, and on the Eagle and Colorado rivers are significant for similar reasons. Blue River and Ten Mile Canyon camp workers generated ties required for the Denver & Rio Grande, and Denver, South Park & Pacific railroads. Both carriers tied together numerous central mountain communities and industries, ultimately connecting them with plains urban centers. The Eagle and Colorado river camps provided ties for the Denver & Rio Grande's Glenwood Springs line, which not only played a similar role in its region, but also was Colorado's most important transcontinental railroad route.

Logging Camp Site Registration Requirements

To qualify for the NRHP, logging camps must meet at least one of the Criteria listed below and possess adequate physical integrity to convey their significance.

Criterion A: Resources eligible under Criterion A must be associated with at least one Area of Significance noted above as well as a contribution to a broad pattern of history.

Criterion B: Logging camps may be eligible under Criterion B provided an association with the life of an important person significant in our past. Presence will most likely be through residence and involvement with the logging operation. The associated resource must retain physical integrity relative to that person's productive life. A brief biography is necessary to detail the

individual's significant contributions. In some cases, important people invested in lumber operations or owned camps but did not occupy the property. Such an association does not meet the registration requirements outlined here. The individual of note must have been present on-site. In general, applying Criterion B is complex, and *National Register Bulletin 32: Guidelines for Evaluating and Documenting Properties Associated with Significant Persons* can provide further guidance.

Criterion C: Logging camps may be eligible under Criterion C when they meet certain conditions. Intact cabins, bunkhouses, and boardinghouses related to logging are likely in the I-70 corridor. Small and simple cabins are the most common types of residences, representing functional vernacular architecture typical of the timber industry. Boardinghouses can reflect the adaptation of residential architecture to the needs of a logging operation and its workforce. Character defining features include adaptations of architecture to environment and geography. For example, logs were common building materials because of availability, steep roofs shed snow, and floorplans were simple with a kitchen, common room, bunk rooms, and often a loft. Character defining features can also include unusual designs, functions, construction methods, and materials uses.

Most logging camps have been reduced to ruins, platforms, and privy pits. On an archaeological level, complexes may be eligible when clearly exemplifying a single- or multiple-residence camp and possess integrity relative to a timeframe of significance. For a site to possess integrity on an archaeological level, its non-architectural features must clearly convey the content and organization of the camp. In addition, the demography and lifestyle of the residents should be interpretable from surface artifacts. Design of the complex is an important characteristic, and it may have been planned or a spontaneous response to local conditions. Evidence of how the residents inhabited the complex and conducted domestic activities is another important attribute. Discernible support facilities are contributing resources.

Criterion D: Logging camps may be eligible under Criterion D if they are likely to yield meaningful information. An analysis of the complex and any architectural features may enlighten existing understanding of camps, architecture, construction methods, and the residential environment associated with the timber industry. Logging camps often possess building platforms, privy pits, and refuse dumps that feature buried archaeological deposits. Testing and excavation may reveal information regarding the lifestyles, social structures, and demography of workers, as well as the presence of women and families. Such studies are important because these subjects have not been extensively documented.

Because most buildings collapsed and materials were salvaged, integrity may be on an archaeological level. For archaeological remains to possess integrity, material evidence should permit a virtual reconstruction of the camp. Common features encountered at logging camps are noted at the section's end.

Most of the seven aspects of integrity defined by the NRHP apply to logging camps, although not all need be present. Standing buildings and structures must retain their original *location* to contribute to a resource's integrity. To retain the aspect of *design*, the camp's material remains, including archaeological features, must convey the complex's organization. To retain the aspect of *setting*, the area around the resource, and the resource itself, must not have changed a great degree from its Period of Significance. Because most camps were isolated, the

natural landscape and areas of stumpage should be preserved. In terms of *feeling*, the resource should convey the sense or perception of housing for loggers. Integrity of *association* exists where aspects of the camp convey a strong connection between logging and a contemporary observer's ability to discern the historic activity that occurred at the location.

PROPERTY TYPE: LOADING STATION

Loading stations, specific to lumber production, were important nodes in the process of moving raw logs from forest to sawmill. In overview, the stations were transfer points where muleskinners dropped off freshly cut logs, with teamsters loading them onto wagons for shipment to a sawmill. Because loading stations were used only as long as timber lasted in a particular area, they were intended to be temporary. Given this, lumber companies invested little in their development, design, and construction. The railroad tie industry had similar facilities known as collection points, discussed below as a separate property type.

Loading stations often grew spontaneously where skid trails descended from a forest and met wagon roads leading out. At the intersection, loggers hacked a clearing where muleskinners could stockpile logs and teamsters transfer them. Workers preferred to harness gravity for moving logs, as with other resource extraction industries, and sited a station on a minor slope. Muleskinners dragged logs out of the forest, aligning them at the clearing's upper end, and inserting chocks, or wedges, to keep them in place. Workers removed the chocks one by one, rolling the logs down to a transfer structure similar to a loading dock, and leveraging them onto a wagon parked alongside. Log stringers spanned the gap between the loading structure and wagon, allowing workers to roll the logs in a continuous movement. Because teamsters had great difficulty maneuvering their wagons, a loop road circled around the station and directed a one-way flow of traffic past the loading structure. By the 1910s, lumber companies increasingly used trucks, which could back up to the loading structure on straight roads, eliminating the need for a complete loop.

Three types of loading structures were used, all vernacular in construction and design. The most common was a log cribbing ramp or platform, usually around 12' wide and 4' high. Workers assembled the cribbing over unaltered ground with saddle-notched joints or spikes, leaving broad gaps between the logs. The wagon or truck merely pulled alongside and received its load. Another common type was an earthen platform or ramp retained by logs. The last, reserved for areas of heavy production and railroad sidings, was a durable ramp or frame assembled from milled timbers.

Loading stations intended for long-term use or heavy production often featured several transfer structures, as well as other facilities in support of the logging operation. They included a storage shed, blacksmith shop, and derrick hoist to manage unwieldy logs. A derrick hoist was a primitive crane with a mast, boom, and winch, all on a swivel base. Cables and ropes guyed the mast, with the base bolted to a stout timber foundation. Logging camps often featured loading stations, and in these cases, the stations would not be a property type in themselves but, instead, a contributing resource to the camp.

Loading Station Significance

Loading stations were associated with the NRHP Areas of Significance: Engineering, Industry, and Transportation. In general, the Period 1860 to 1920 covers the timber industry as a theme throughout the entire I-70 corridor, but narrower timeframes may be more applicable to specific regions: 1860 to 1920 in Clear Creek drainage; 1879 through 1912 in Summit County; and 1886 to 1920 along the Eagle and Colorado rivers. Level of significance was local.

Area of Significance: Engineering: Although loading stations were vernacular, they were significant in the Area *Engineering*. Loggers planned stations in the field to facilitate a flow of logs out of the forest, onto drayage vehicles, and to a sawmill. Design had to account for muleskinner traffic out of the forest, stockpiling the logs, using gravity to move them onto wagons, and traffic to the sawmill. With locally harvested logs and little else, the loggers adapted designs of loading docks and similar structures to complete functional stations.

Areas of Significance: Industry and Transportation: Loading stations permitted lumber companies the use of wagons and trucks for hauling logs great distances to sawmills. Lumber outfits were able to work deeper in the forest and harvest larger and heavier trees than could be moved by dragging. As a result, companies were able to increase areas of harvest, expand operations, and improve efficiency. Loading stations were instrument in the continuation of lumber production long after easily harvested trees were gone, prolonging the timber industry.

Loading Station Registration Requirements

To qualify for the NRHP, loading stations must meet at least one of the Criteria listed below and possess adequate physical integrity to convey their significance.

Criterion A: Resources eligible under Criterion A must be associated with at least one Area of Significance noted above as well as a contribution to a broad pattern of history.

Criterion B: Loading stations may be eligible under Criterion B provided association with the life of an important person significant in our past. Presence will most likely be through employment with the logging operation. The associated resource must retain physical integrity relative to that person's productive life. A brief biography is necessary to detail the individual's significant contributions. In some cases, important people invested in lumber operations but did not work on-site. Such an association does not meet the registration requirements outlined here. The individual of note must have been present on-site. In general, applying Criterion B is complex, and *National Register Bulletin 32: Guidelines for Evaluating and Documenting Properties Associated with Significant Persons* can provide further guidance.

Criterion C: Loading stations may be eligible under Criterion C when they exemplify the resource type outlined above and possess integrity relative to the Period of Significance. Archaeological features and artifacts may represent the station because materials were typically removed, and the remaining structural elements disintegrated. However, when a site's material evidence clearly conveys the station's organization pattern, movement of logs, and associated

structures, the site retains archaeological integrity. Intact structures are rare and therefore significant examples of engineering and construction specific to the movement of logs from forest to sawmill. Character defining features must be evident, even if on an archaeological level. The log staging area, remnants of the loading structure, transportation segments, and other facilities should be discernible.

Criterion D: For eligibility under Criterion D, the loading station must be likely to yield important information upon further study. Because most stations are simple and offer little beyond the loading structure and roads, they are unlikely to qualify as most information can be collected during initial recordation. Several exceptions may exist. First, testing and excavation of buried archaeological deposits such as privy pits or substantial refuse dumps may reveal information regarding timber industry workers' lifestyles, social structures, and the workplace. Second, if the station was large and complex, it may enhance current understanding of how lumber outfits moved logs from forest to mill.

Eligible loading stations must possess physical integrity relative to one of the timber industry timeframes of significance. Most loading stations had few structures except for loading frames, so integrity may be on an archaeological level. For archaeological remains to possess sufficient integrity, they should permit the virtual reconstruction of the facility and its operation. A station retains integrity on an engineering level if the loading structures are present and intact. Common features encountered at loading stations are noted below.

Most of the seven aspects of historic integrity defined by the NRHP apply to loading stations, although not all need be present. Intact structures and buildings must be in their original places to retain integrity of *location*. For a resource to retain integrity of *design*, material remains, including archaeological features, must convey the facility's organization and engineering. To retain *setting*, the area around the station, and the resource itself, must not have changed a great degree from its Period of Significance. Loading stations were usually isolated, in a natural landscape with areas of stumpage. If the resource lies adjacent to a railroad grade, then the grade should retain integrity if on an archaeological level. In terms of *feeling*, the resource should convey the perception of logging. Integrity of *association* exists where structures and other features convey, to a contemporary observer, the collection and transfer of logs.

PROPERTY TYPE: TIE COLLECTION POINT

Tie collection points were to the railroad industry what loading stations were to lumber production. Specifically, tie collection points were exchanges between tie hacks in the forest and tie recipients, railroad companies or their contractors. Tie hacks dragged finished ties out of the forest and stockpiled them at stations, where teamsters transferred the ties onto their wagons for shipment to consumer. When possible, tie hacks instead preferred to float ties down rivers and streams to retrieval points. In the I-70 corridor, only the Eagle and Colorado rivers provided sufficient flows for this practice, and tie collection points may have existed along their banks.

In overview, tie collection points were simple facilities relatively close to tie hack camps. Like loading stations, they manifested as clearings where skid trails converged and main roads led out. Unlike loading stations, however, special structures to transfer ties onto wagons were

unnecessary. Because ties were light and small, one or two workers could easily lift them into wagons. Tie hacks dragged their products out of the forest and into the clearing, neatly stacking them over log bolsters often crosshatched in layers 4' to 8' high. A teamster then parked his wagon alongside and transferred the ties. A single station could have featured multiple stacks built by different teams. The clearing often featured a loop road to facilitate a one-way flow of wagon traffic, although, by the 1910s, railroad companies increasingly used trucks that could back up. As a result, truck roads tended to be straight.

In some areas, tie production was heavy enough to justify simple transfer structures for moving ties onto wagons or trucks. The most common type was a ramp or platform made with log cribbing, usually around 6' wide and 4' high. The wagon or truck merely pulled alongside, and workers rolled the ties onto the vehicle. An earthen platform retained by logs was another type. The most productive tie collection points may offer evidence of these structures, as well as a storage shed and stable. Most collection points, however, were simple and now manifest as clearings, wagon roads, log bolsters, and possibly loose ties as surface scatters. When a collection point is a component of logging camp, it should be considered a contributing resource.

Tie Collection Point Significance

Tie collection points were associated with NRHP Areas of Significance of Industry and Transportation. In general, the Period 1860 to 1920 covers the timber industry throughout the I-70 corridor. But ties were only produced with the advent of railroads. Thus, narrower Periods of Significance apply: 1877 to 1920 in Clear Creek drainage; 1881 through 1912 in Summit County; and 1886 to 1920 along the Eagle and Colorado rivers. Level of significance was local.

Area of Significance: Industry: Collection points were important in the area of *Industry* because they enhanced the ability of tie producers to work deep in the forest, beyond the immediate confines of a railroad corridor, with use of wagons and trucks. By improving the flow of finished ties out of the forests, collection points improved the long-term viability of the industry.

Area of Significance: Transportation: Locally produced ties were essential to the railroads constructed in Clear Creek, Summit, and Eagle counties. Not only were collection points key during the initial railroads construction, but also for regular maintenance allowing railroads to continue operations.

Tie Collection Point Registration Requirements

To qualify for the NRHP, tie collection points must meet at least one of the Criteria listed below and possess adequate physical integrity to convey their significance.

Criterion A: Resources eligible under Criterion A must be associated with at least one Area of Significance noted above as well as a contribution to a broad pattern of history.

Criterion B: Tie collection points may be eligible under Criterion B provided association with the life of an important person significant in our past. Presence will most likely be through employment with the tie operation or transportation firm. The associated resource must retain

physical integrity relative to that person's productive life. A brief biography is necessary to detail the individual's significant contributions. In some cases, important people contracted ties but did not work on-site. Such an association does not meet the registration requirements outlined here. The individual of note must have been present on-site. In general, applying Criterion B is complex, and *National Register Bulletin 32: Guidelines for Evaluating and Documenting Properties Associated with Significant Persons* can provide further guidance.

Criterion C: Tie collection points may be eligible under Criterion C when they exemplify the resource type outlined above and possess integrity relative to a Period of Significance. The tie staging area; evidence of tie stacks; log bolsters for the ties; transportation segments; and remnants of loading structures, if any existed, should be discernible. Integrity may be on an archaeological level since the above aspects were not engineered constructs and collection points rarely had buildings.

Criterion D: For eligibility under Criterion D, collection points must be likely to yield important information upon further study. Because most are simple and offer little beyond a clearing and scattered ties, they are unlikely to qualify as most information can be collected during initial recordation. Several exceptions may exist. First, testing and excavation of buried archaeological deposits such as privy pits or substantial refuse dumps may reveal information regarding timber industry workers' lifestyles, social structures, and the workplace. Second, if the collection point was large and complex, it may enhance the current understanding of how producers moved ties from forest to consumer.

Eligible collection points must possess physical integrity relative to one of the tie industry Periods of Significance. Integrity may be on an archaeological level because most collection points lacked structures or buildings. Instead, they tended to consist of tie stacks, roads, and possibly earthen platforms. For archaeological remains to possess sufficient integrity, they should permit the virtual reconstruction of the collection point and movement of ties. Common features encountered at collection points are noted below.

Most of the seven aspects of integrity defined by the NRHP apply to collection points, although not all need be present. Intact structures and tie stacks must be in their original places to retain integrity of *location*. For a resource to retain integrity of *design*, the collection point's material remains, including archaeological features, must convey the facility's organization and operation. To retain *setting*, the area around the resource, and the resource itself, must not have changed a great degree from its Period of Significance. Collection points were usually isolated, in a natural landscape, with areas of stumpage. If the resource lies adjacent to a railroad grade, then the grade should retain integrity at least on an archaeological level. In terms of *feeling*, the resource should convey the perception of tie production. Integrity of *association* exists where structures and other features convey, to a contemporary observer, tie collection and transfer.

PROPERTY TYPE: FLUME

A flume was an engineered water system conveying raw logs from forest to sawmill, or finished lumber from sawmill to distribution point. A cost-effective, functional flume required three critical resources including a reliable source of water, capital to engineer the structure, and enough timber to justify the expense. Although lumber companies generally preferred flumes

over wagons and railroads, those in the I-70 corridor had difficulty securing the requisite resources. Timber stands were inadequate, companies small and undercapitalized, and water rights costly, providing any available. Few lumber companies in the I-70 corridor built flumes as a result, but several did complete short systems. The Clear Creek Fluming Company constructed what may have been the longest in 1881 (see Illustration A 2.4). Its flume carried both logs and sawed lumber from the High Line Sawmill at Fisk's Station near Loveland Pass down to a company yard in Silver Plume.⁶⁸²

Although most flumes were vernacular, custom-built, engineered structures, they were based on a common template. In overview, a flume was a watertight, wooden trough 2' to 4' in depth and as wide, supported by framing. The flume had to descend a gentle and continuous angle from head to tail to establish a current, while contouring across existing topography. These characteristics required formal surveying and engineering. Workers usually excavated a bed for the flume when on a slope, poured fill into minor drainages, and built the subframe directly at grade.

To save costs, lumber companies kept structural elements as simple as possible. The trough itself was either in box form with plank walls and a floor, or in V form with angled plank sides. Closely spaced box-frame sets wrapped around the floor and walls, tying them to a subframe underneath. The typical subframe consisted of two or four parallel timber stringers supporting the trough, sometimes over cross-members and a second layer of stringers.

Whenever possible, lumber companies laid the flume directly on an earthen bed, with rocks and logs filling in low areas. Occasionally, trestles spanned substantial drainages and crossed rock outcrops where a bed was impossible, but their use was limited due to cost. Where vertical relief and distance was short, the trestle may have been little more than pairs of log posts supporting the flume's subframe. Otherwise, the trestle was formally engineered with a series of piers on timber footers and tied together with horizontal braces and timber stringers.

The flume head featured two facilities vital to its function as a transportation system. One was a water diversion structure, usually a low dam, in a stream. The dam, often log cribbing filled with gravel, was designed to slow the stream, elevate the water level, and shunt some of the flow through a headgate. The other facility was a loading station where workers transferred logs or lumber into the flume for shipment. A loading station consisted of little more than a ramp or platform of log cribbing allowing logs to slide into the trough.

The flume tail featured another station where workers retrieved the logs and lumber. The products either dropped out of the end and into a pond or bumped against a screen and were lifted out. In general, flumes ranged from hundreds of feet to miles in length. Like railroad grades and roads, flumes should be recorded as linear resources.

Flumes, in entirety or segmented, should be recorded as linear resources. To describe and evaluate contributing segments, consult Appendix VI in *National Register Bulletin 16A: How to Complete the National Register Registration Form*. Although flumes are not specified in the Bulletin, they can be treated similarly to railroads.

⁶⁸² Ellis, Erl H. and Ellis, Carrie Scott. *The Saga of Upper Clear Creek: A Detailed History of an Old Mining Area, Its Past and Present*. Frederick, CO: Jende-Hagan Book Corporation, 1983,150.

Flume Significance

The most relevant NRHP Areas of Significance for flume resources are: Engineering, Industry, and Transportation. The Period of Significance 1860 to 1920 covers the timber industry throughout the I-70 corridor, but narrower timeframes may be applicable to specific regions: 1877 to 1920 in Clear Creek drainage; 1879 through 1912 in Summit County; and 1886 to 1920 along the Eagle and Colorado rivers. Level of significance was local.

Areas of Significance: Industry and Transportation: In the Areas of *Industry* and *Transportation* flumes improved the efficiency of lumber companies, allowing them to increase production. Those flumes that delivered crude logs from an area of harvest to a sawmill enhanced the ability of lumber outfits to work deep in the forest and transport logs great distances to the sawmill. Those flumes that carried finished lumber from a sawmill to distribution station or yard improved the ability of logging companies to move their products to market. Over the long term, this lowered operating costs and increased productivity, prolonging the lives of associated lumber companies.

Area of Significance: Engineering: Flumes were significant in the area of *Engineering* as components of designed, large-scale transportation systems. In particular, flumes were integral to moving logs from forest to sawmill, delivering products to a distribution point. When planning a flume, a logging outfit had to consider a number of variables to ensure the system functioned efficiently. The company had to secure a source of water, build a durable diversion structure, extend the flume through areas being logged, incorporate loading stations, and establish a station at the sawmill. If the flume carried finished lumber, the flume had to end at an appropriate yard.

The overall route had to account for the water source, logging operations, topography, local land features, and exacting specifications. The bed required consistent gradient, while trestles over low points had to support considerable weight. The flume itself had to be watertight and withstand the impacts of logs and lumber. When constructing flumes, logging outfits adapted known engineering techniques to the most primitive environmental conditions including difficult terrain, inaccessibility, and an undeveloped landscape. In so doing, the outfits collectively contributed to lumber production practices and water structure engineering and systems.

Flume Registration Requirements

To qualify for the NRHP, flumes must meet at least one of the Criteria listed below and possess adequate physical integrity to convey their significance.

Criterion A: Resources eligible under Criterion A must be associated with at least one Area of Significance noted above as well as a contribution to a broad pattern of history.

Criterion B: Flumes may be eligible under Criterion B provided association with the life of an important person significant in our past. Presence will most likely be through employment with the logging operation. The associated resource must retain physical integrity relative to that person's productive life. A brief biography is necessary to detail the individual's significant contributions. In some cases, important people invested in lumber operations or flumes but did not occupy the property. Such an association does not meet the registration requirements outlined

here. The individual of note must have been present on-site. In general, applying Criterion B is complex, and *National Register Bulletin 32: Guidelines for Evaluating and Documenting Properties Associated with Significant Persons* can provide further guidance.

Criterion C: Flumes may be eligible under Criterion C in two general circumstances. Isolated segments may be individually eligible if they clearly represent the flume structure. Defining characteristics including the bed and subframe must be present to represent the structure's design, construction methods, and materials. The end points of the eligible segment should be clearly defined.

Flumes can be eligible in their entirety only when the head and tail points are evident, and most of the connecting bed or route discernible. Further, the bed should possess archaeological or engineering features clearly representing the flume itself and structures built to overcome obstacles. For a flume bed to retain integrity on an archaeological level, the material evidence should clearly represent the flume route, end points, and intermediate stations. In general, intact structures such as the trough, its subframe, and trestles are uncommon, significant representations of water system engineering and technology.

Criterion D: An entire flume system, or individual segments, may be eligible under Criterion D if further studies will yield important information upon further study. For the entire system to qualify, it must be discernible from end to end with important facilities in between identifiable. The flume should be examined in the context of the logging operation feeding the system. Areas of inquiry include route engineering, how the flume interacted with the logging operation, how materials transportation was managed, and how the flume affected patterns of timber harvest. Water management is a potential area of inquiry, in terms of source, input controls, tail, and where water flowed. Individual flume segments may be eligible if structural elements remain intact. They may reveal information regarding how flumes were designed and constructed and what materials were incorporated. In general, lumber production systems, water management, and flume design and construction are important topics of inquiry because their presence in the Rocky Mountains is not well documented.

Eligible flumes must possess physical integrity relative to one of the Periods of Significance noted above. For archaeological sites to possess sufficient integrity, material evidence should represent most of the flume bed as well as segments of the flume structure. Common features encountered at flumes are noted below.

Most of the seven aspects of historic integrity defined by the NRHP apply to flumes, but not all need be present. Intact structures must be in their original places to retain integrity of *location*. For a flume to retain *design* on a system-wide scale, the flume or its bed must reflect planning, engineering, and integration with the logging operation and terrain. Individual segments retain integrity of *design* when elements of the flume structure represent the planning and design of the trough and its support system. To retain *setting*, the area around the flume, and the resource itself, must not have changed a great degree from its Period of Significance. If the flume is isolated, then the natural landscape and areas of stumpage should be preserved. In terms of *feeling*, the resource should convey the perception of logging and the transportation of forest products. Integrity of *association* exists where structures and other features convey a strong connection between logging and a contemporary observer's ability to discern the flume function.

PROPERTY TYPE: RURAL HISTORIC TIMBER INDUSTRY LANDSCAPE

As large-scale cultural resources, rural historic landscapes can reveal the history of an area's human occupation, life ways, and the relationship with the land. The National Park Service explains Rural Historic Landscapes in detail in its *National Register Bulletin: Guidelines for Evaluating and Documenting Rural Historic Landscapes*. In overview, the Bulletin states:

A rural historic landscape is defined as a geographical area that historically has been used by people, or shaped or modified by human activity, occupancy, or intervention, and that possesses a significant concentration, linkage, or continuity of areas of land use, vegetation, buildings and structures, roads and waterways, and natural features.⁶⁸³

By contrast to designed historic landscapes, rural historic landscapes evolved organically over time. In the I-70 corridor, rural, historic landscapes can provide broader context for historic resources left by the timber industry.

The National Park Service defines eleven characteristics of rural historic landscapes. The first four are a result of processes instrumental in shaping the land, and the last seven are physical attributes apparent on the land.⁶⁸⁴ All are tangible evidence of the activities, values, and beliefs of the people who occupied, developed, used, and shaped the land to serve human needs. The categories are: land uses and activities; patterns of spatial organization; response to the natural environment; cultural traditions; circulation networks; boundary demarcations; vegetation related to land use; buildings, structures, and objects; clusters; archaeological sites; and small-scale elements.

The defining characteristics of a rural historic landscape also can be described in terms of "landscape of work."⁶⁸⁵ When loggers developed large tracts of the natural environment for their operations, they molded the landscape for efficiency, organization, and suitability of timber harvest. Landscapes of work for logging feature defining characteristics and patterns. A common pattern included a central sawmill and satellite logging camps in the surrounding forest. Within each complex, the buildings and facilities were often clustered for efficiency of industrial operations and domestic work. Circulation systems in the form of roads and skid trails linked the cut areas with associated nodes of activity such as loading stations and the sawmill. Although industry preferred the geometry of straight boundaries, age and tree species within a forest stand determined harvest area shape and size.

Few timber industry landscapes of work are still being logged, but most offer some evidence of associated use. The logging industry had tangible impacts on I-70 corridor by changing its vegetation patterns, contributing to the development of road and railroad networks, and providing the physical materials used for many buildings and structures. Timber industry sites and aspects of the natural environment are interspersed, and both should be considered together as a whole.

⁶⁸³ McClelland, Linda Flint; Keller, J. Timothy; Keller, Genevieve P.; Melnick, Robert Z. *National Register Bulletin: Guidelines for Evaluating and Documenting Rural Historic Landscapes* National Park Service, 1999, 1.

⁶⁸⁴ McClelland, et al., 1999:3.

⁶⁸⁵ Messick, Denise P.; Joseph, J.W.; Adams, Natalie P. *Tilling the Earth: Georgia's Historic Agricultural Heritage, A Context* Stone Mountain, GA, New South Associates, 2001, 62.

Rural Historic Timber Industry Landscape Significance

Because timber industry landscapes are large in scale, their significance as cultural resources can be assessed in a broad sense. The most relevant NRHP Areas of Significance include Architecture, Economics, Engineering, Exploration/Settlement, Industry, and Transportation. Because timber industry landscapes are diverse, complex, and exhibit numerous historic resources, most will be significant under multiple NRHP Areas and criteria. The Period of Significance 1860 to 1920 covers the timber industry throughout the I-70 corridor, but narrower Periods of Significance may be applicable to specific regions: 1877 to 1920 in Clear Creek drainage; 1879 through 1912 in Summit County; and 1886 to 1920 along the Eagle and Colorado rivers.

Area of Significance: Architecture: Those historic landscapes with standing buildings may be important in the Area of *Architecture*. Loggers adapted familiar building forms, designs, and methods of construction to the Rocky Mountain forests. In their adaptation, loggers responded to topography, natural landscape features, local climate, and available building materials. When distributed amid a landscape, buildings can represent the evolution of rural architecture specific to logging.

Area of Significance: Conservation: Timber industry landscapes may be significant in the Area of *Conservation* when involved in purposeful forest management. By the 1890s, federal and state foresters began regulating logging in the I-70 corridor to preserve and manage timber resources threatened by unsustainable and damaging harvest practices. Through purposeful management, they defined tracts for harvest and others for preservation, and even specified the minimum ages for target trees. Through these policies and others, conservation shaped the land.

Area of Significance: Economics: In the Area of *Economics*, timber industry landscapes are a direct manifestation of converting natural resources into capital. Entire forests in the corridor were cut, milled, and used locally or shipped. Each processing stage and the trees themselves generated income, as well as other types of exchange. Much wealth remained within the corridor and became a major contribution to regional economic systems. The capital used to organize, equip, and support logging companies shaped the land through their development and timber harvests.

Area of Significance: Engineering: Rural historic landscapes can represent the widespread adaptation of *Engineering* practices to the central Rocky Mountains. Representation may be through small-scale resources or large systems expressed across an entire landscape. With small-scale resources, logging operations may have adapted familiar types of structures and machinery to the mountain environment. Logging operations may have also innovated new ways of solving problems posed by the land and its resources. On a large scale, landscapes may feature engineered systems such as transportation networks or represent the incremental process of turning trees into lumber

Area of Significance: Exploration/Settlement: Timber industry landscapes can be important in the Area of *Exploration/Settlement* if they reveal settlement and land use patterns. Landscapes

can reflect development patterns of individual logging camps, logging as a regional industry, and its influence on regional communities.

Area of Significance: Industry: Logging was one of the few long-term regional industries, and although it suffered during periods of depression and resource exhaustion, logging provided jobs and converted natural resources into capital. Further, many products were vital to settlement and other industries in the corridor. Logging generated timbers for mining and firewood, the most common heating fuel. Lumber companies made possible local construction, and tie outfits had a like relationship with the railroads.

Area of Significance: Transportation: Logging depended on transportation systems to haul trees to sawmills and finished products to market. Because of this, the timber industry fostered entire networks of skid trails, roads, and railroads in the corridor. The transportation systems were significant to logging and that industry's impact on the land. The systems were also significant because they affected other industries, settlement, historic trends, and land use.

Rural Historic Timber Industry Landscape Registration Requirements

To qualify for the NRHP, timber industry landscapes must meet at least one of the Criteria listed below and possess adequate physical integrity to convey their significance.

Criterion A: Resources eligible under Criterion A must be associated with at least one Area of Significance noted above as well as a contribution to a broad pattern of history.

Criterion B: Large-scale and small-scale landscapes may be eligible under Criterion B through association with the life of an important person significant in our past. Presence will most likely be through residence, employment, or other involvement with a logging operation. The landscape must retain physical integrity relative to that person's occupation during their productive life. A brief biography is necessary to detail the individual's significant contributions. In some cases, important people invested in lumber operations or owned sawmills but did not occupy the property. Such an association does not meet the registration requirements outlined here. The individual of note must have been present on the ground. In general, applying Criterion B is complex, and *National Register Bulletin 32: Guidelines for Evaluating and Documenting Properties Associated with Significant Persons* can provide further guidance.

Criterion C: Rural historic landscapes may be eligible under Criterion C if buildings, structures, and landscape features represent logging operations, manipulation of the natural environment for timber resources, or development patterns of associated communities. Because landscapes were occupied for extended periods of time, the patterns can reflect the evolution of general land use through the Period of Significance. Intact buildings may be significant representations of architecture specific to logging in the central mountains. Multiple buildings within a single landscape may represent the evolution of type, style, methods, workmanship, and materials. Similarly, structures may be significant representations of engineering specific to logging, and multiple structures within a single landscape may represent the evolution of function, design, methods, workmanship, and materials. Buildings and structures may also exemplify characteristics distinct to the corridor. Natural features often are contributing elements.

Criterion D: Buildings, structures, and land modifications often left archaeological evidence when removed or abandoned. When this evidence clearly represents land use patterns, then the landscape retains integrity on an archaeological level. For archaeological remains to retain integrity, material evidence should represent the general layout of individual sites as well as their relationships to communities and the land. If archaeological features and artifacts offer important information regarding land use, the application of engineering, or logging practices, then the landscape may qualify under Criterion D.

If complexes within the landscape possess building platforms, privy pits, and refuse dumps, testing and excavation of these buried archaeological deposits may reveal important information regarding lifestyle and demography of the occupants. When the results from multiple complexes are compared, regional patterns may become apparent. Important areas of inquiry include but are not limited to diet, health, and substance abuse. Other areas of inquiry relate to the distribution of gender, families, ethnicities, professional occupation, and socioeconomic status.

Rural historic timber industry landscapes eligible for the NRHP must possess physical integrity relative to their Period of Significance. According to the rural historic landscape National Register Bulletin: “Integrity requires that the various characteristics that shaped the land during the historic Period be present today in much the same way they were historically.”⁶⁸⁶ Continued occupation and use, however, changed logging landscapes in the corridor to some degree. Occupation and use are compatible with integrity when they maintain the character and feeling of historic logging operations. Recreation, forestry, and continuation of logging are compatible, while modern intrusions should be few and unobtrusive. The presence of some landscape characteristics is more important to integrity than others. Areas of stumpage, preserved forests, historic circulation systems, and the types of small-scale features typical of logging should be evident.

Many of the seven aspects of historic integrity defined by the NRHP apply to logging landscapes, although not all need be present. *Location* is the place where significant activities that shaped land took place. A rural landscape whose characteristics are in their historic place has integrity of location. For integrity of *design*, the landscape features, both manmade and natural, must convey organization and planning typical of logging. *Setting* is the physical environment within and surrounding a historic property. To retain integrity of setting, a landscape and bordering area must not have changed a great degree in overall character. Because the timber industry worked in the natural environment and especially forests, aspects of both should be present. For integrity of *feeling*, the landscape should convey logging and associated settlement identifiable from a historical perspective and in the context of today’s perceptions. Integrity of *association* exists where a combination of natural and manmade features conveys a strong connectedness between the landscape and a contemporary observer’s ability to discern the historic timber industry and settlement.

⁶⁸⁶ McClelland, et al., 1999:21.

TIMBER INDUSTRY SITE FEATURES

Sawmill Feature Types

The types of features specific to sawmill complexes are listed below. As recipients of logs and distributors of lumber, sawmills were centers of transportation networks that included skid trails, roads, and sometimes flumes. Lumber companies also provided housing for loggers and the sawmill crew. Given this, today's sawmill sites often include related buildings, structures, and archaeological features (see Illustration B 2.3).

Features Representing the Sawmill

Boiler: A boiler was a vessel that generated steam for a sawmill's drive engines. Most boilers were portable upright, locomotive, or Pennsylvania types. *Upright boilers* were the least costly and easiest to transport, but also the most inefficient. They featured a vertical shell over a firebox and a smokestack on top. To heat water inside the shell, flue gases rose from the firebox through a cluster of tubes in the shell and exited the smokestack. Upright boilers were self-contained and stood on a cast-iron base requiring no foundation, although workers often placed them on rock pads. The shells ranged from 2' in diameter and 7' high to 5' in diameter and 12' high.

The *locomotive boiler* was one of the most popular and derived its name from its application in railroad locomotives. The boiler consisted of a horizontal shell perforated with flue tubes, a firebox underneath one end, and an attachment for a smokestack at the other. The firebox and shell were manufactured as a single, riveted iron unit, which stood on skids. To heat water, hot flue gases left the firebox, traveled through the tubes, and exited the smokestack. Small boilers featured a shell 2' in diameter, 4' high including the fire box, and as long as 8'. Large units featured a 5' diameter shell, stood 9' high, and were up to 23' long. Medium-sized boilers, in between in size, were usually employed at sawmills.

The *Pennsylvania boiler* was similar in appearance to locomotive units and stood on skids, but the flue gases traveled a different and more efficient path. They left the firebox, traveled through the shell via a set of lower tubes, gathered in a chamber at the shell rear, returned through an upper set of tubes, and exited the smokestack. Pennsylvania boilers featured a horizontal shell with a firebox under one end, a sealed rear, and a manifold for a smokestack over the firebox.

Boiler Foundation: Because portable boilers were self-contained and free-standing, their sites required little formal preparation beyond an earthen platform adjacent to the sawmill. Some lumber outfits installed *upright boilers* on square or circular dry-laid rock pads or over shallow pits that collected ashes from the firebox. *Pennsylvania* and *locomotive boilers* stood on skids, which usually required no support. Where the ground was soft or uneven, workers often laid parallel rock alignments to prevent the boiler from settling. In the absence of rock supports, the skids occasionally created two parallel depressions the length and width of the boiler. The artifact assemblage around a foundation or platform should include clinker, unburned bituminous coal, ash, water-level sight-glass fragments, and pipe fittings.

Engine Foundation: Drive engines, steam and petroleum, powered saws and other machinery via canvas drive-belts. This required a location adjacent to the mechanical components of a saw-frame. The engines were bolted to timber footers fastened either to the saw-frame or anchor logs embedded in the ground.

Flume: Cutting logs into lumber generated high volumes of sawdust that had to be disposed of as waste. Most sawmills had a plank flume, 1'x1' to 2'x2' in height and width, extending underneath the saw-frame to carry the sawdust to a dump somewhere downslope from the mill.

Flume Remnant: The collapsed remnants of a flume.

Loading Platform: The head of the sawmill featured an elevated platform where workers staged raw logs to be cut into lumber. The platform, concurrent in elevation with the mill's saw-frame, was either a framework of logs or an earthen pad with log bolsters. Workers rolled logs off the platform and fastened them to a dolly on the saw-frame.

Loading Platform Remnant: The decayed remnants of a loading platform.

Log Dolly: A log dolly was a carriage that rolled on a track of steel or timber rails the length of the saw-frame. The dolly braced individual logs for reduction into lumber. Workers clamped the log in place and winched the dolly toward the mill's saw blades.

Log Stockpile: A pile or stack of raw logs staged for reduction into lumber.

Mill Slab Pile: Mill slabs were the bark-clad rinds cut away from raw logs during milling. Because mill slabs had little commercial value, lumber companies stacked them in piles as waste.

Platform: An intentionally graded flat area or workspace.

Sawdust Dump: Sawmills usually relied on a small flume to carry sawdust away and downslope from the saw-frame. The flume dumped the sawdust directly onto the ground, creating a thick deposit over time.

Saw-Frame: The saw-frame, the principal component of a sawmill, was a linear timber structure that supported mechanical saws, dollies, and the engine. Saw-frames were 30' to 100' long, 3' to 6' wide, and as high. The frame was bolted to a foundation of timber footers and stringers usually laid on an earthen platform.

Saw-Frame Platform: Saw-frames stood on linear, flat areas often paved with earthen fill. When the frame was removed, its platform typically remains. The platform approximates the frame's footprint and usually features impressions left by the frame's timber footers and stringers. Sawdust, wood chips, and mechanical artifacts should be present.

Saw-Frame Remnant: The decayed remnants of a saw-frame.

Sawmill Building: To shelter workers and equipment from adverse weather, lumber companies enclosed the saw-frame and drive mechanism in a frame building vernacular in design and construction. Based on a shed, most were open on one side, and elongated to enclose the saw-frame. The lumber outfit adapted conventional construction methods to meet its needs, budget, and integration with the sawmill.

Sawmill Building Platform: When dismantled, sawmill buildings usually left an earthen platform and impressions from the foundation footers. These aspects generally outline the building's footprint and encompass evidence of the saw-frame and drive mechanism.

Steam Engine: Prior to the 1920s, steam donkey engines powered sawmills. The apparatuses were either vertical or horizontal in configuration and had flywheels for canvas drive-belts.

Utility Engine: By the 1920s, lumber companies used petroleum engines to drive sawmill machinery. The engine was usually bolted to a timber foundation adjacent to the saw mechanism on the mill's saw-frame. Engines of the 1920s and 1930s may have been single-cylinder units with large flywheels that powered machinery via canvas drive-belts. Later engines were similar to those in trucks, with a cowling, radiator, and chassis.

Sawmill Support Facilities

Building Platform: Sawmills had ancillary buildings that usually stood on earthen platforms amid the complex. In most cases, the buildings were removed, leaving the platform and associated artifacts. The archaeological feature can be recorded as a generic building platform if the building function cannot be determined.

Building Ruin: The collapsed debris left by an ancillary building.

Cistern: Sawmills powered by steam occasionally included cisterns to store boiler water. Cisterns were vernacular structures countersunk into the ground and constructed with rock masonry, concrete, or planks.

Corral: Lumber companies relied on draft animals to deliver logs to the mill and haul away finished lumber. Most sawmills had corrals for the animals, and they were fenced with piles of rocks, debris, wires lashed to trees, and rails fixed to posts.

Corral Remnant: The decayed remains of a corral.

Incinerator: When in one location for a prolonged time, lumber companies installed incinerators to burn waste. Incinerators were often prefabricated structures similar to inverted cones, and they ranged from 8' to 20' in diameter and as high. The base featured a doorway, and screens at top arrested sparks.

Incinerator Foundation: When an incinerator was removed, it left either an earthen pad or concrete foundation engulfed by ash and charcoal.

Shop: Most sawmills included a shop in which a worker fabricated and maintained tools and hardware. Simple shops usually featured a blacksmith forge, anvil, workbench, and hand-powered appliances such as a drill press. At large sawmill complexes, the shop may have been equipped for carpentry, as well. The buildings were vernacular in materials and construction, gabled or shed in form, and usually less than 20'x30' in area. Workers designed shops in the field for function and cost and assembled them with logs and occasionally lumber. Wide doorways, a window, and a stovepipe port over the forge are defining characteristics. Anthracite coal and forge clinker should blanket the floor.

Shop Platform: Blacksmith shops usually stood on earthen platforms, which represent the facility after the building was dismantled. Shop platforms often feature forge remnants and artifacts such as forge-cut iron scraps, anthracite coal, and clinker, which is a scorious, ashy residue created by burning coal.

Shop Ruin: The collapsed remnants of a shop.

Shop Refuse Dump: Prolonged shop work generated waste that blacksmiths threw outside their buildings. Over time, they created a distinct artifact assemblage of forge clinker, forge-cut iron scraps, cut pipe scraps, and pieces of

hardware. Forge clinker consists of small pieces of scorious, ashy residue and unburned anthracite coal. Carpentry shops left an abundance of cut wood scraps, sawdust, and hardware.

Stable: Sawmill complexes often featured stables to house draft animals. The buildings were vernacular in materials and construction, gabled or shed in form, and usually less than 20'x30' in area. Workers designed stables in the field for function and cost and assembled them with logs and occasionally lumber. Wide doorways, open gaps in the walls, a manger, and possibly an oat box are defining characteristics. Because stables were not residences, they offer few if any domestic artifacts.

Stable Ruin: The collapsed remains of a stable.

Logging Camp Feature Types

The types of features specific to logging camps are listed below. The camps were also centers of transportation networks that included skid trails, roads, and sometimes flumes.

Logging Camp Buildings

Log Boardinghouse – Character-Defining Features

See Mining Settlement Building Types.

Frame Boardinghouse – Character-Defining Features

See Mining Settlement Building Types.

Log Bunkhouse – Character-Defining Features

See Mining Settlement Building Types.

Frame Bunkhouse – Character-Defining Features

See Mining Settlement Building Types.

Single-Pen Log Cabin – Character-Defining Features

See Mining Settlement Building Types.

Double-Pen Log Cabin – Character-Defining Features

See Mining Settlement Building Types.

Rectangular Plan Frame Cabin – Character-Defining Features

See Mining Settlement Building Types.

Privy – Character-Defining Features

See Mining Settlement Building Types.

Logging Camp Structures and Archaeological Features

Boardinghouse Platform: Boardinghouses usually stood on earthen platforms, which represent a building after the architectural elements are gone. The platform may feature rock or log footers for the building and a collapsed root cellar for food storage underneath. The platform or footers often outline the building's size and footprint.

Boardinghouse Ruin: The structural remnants of a boardinghouse.

Bunkhouse Platform: Bunkhouses stood on the same types of earthen platforms described above for boardinghouses, but without root cellars. The platform should feature few food-related artifacts because meals were generally prepared and consumed elsewhere.

Bunkhouse Ruin: The structural remnants of a bunkhouse.

Cabin Platform: Cabins usually stood on earthen platforms, which represent a building after the architectural elements are gone. The platform may feature rock or log footers outlining the building's size and footprint.

Cabin Ruin: The collapsed remains of a cabin.

Cellar Pit: Cellars, mistaken for dugout residences, were subterranean structures underneath cabins and boardinghouses for cold storage of perishable food. They usually had plank or log walls retaining an earthen pit, surrounded by the building foundation or platform.

Cistern: Organized, well-capitalized camps occasionally included cisterns to store potable water. Cisterns were countersunk into the ground and were constructed with rock masonry, concrete, or planks.

Corral: Because the logging industry relied on draft animals, camps almost always included a corral. Some fences were properly constructed with wire and posts, and most were bounded by alignments of stumps, cut slash, and logs with natural features.

Corral Remnant: After abandonment, corrals may feature evidence of their boundaries such as wires, branches, upended stumps, individual fence posts, and cobble alignments marking a fence line. The interior should either be open or feature vegetation younger than in the surrounding area.

Developed Spring: Loggers and their draft animals depended on water for existence, and preferred springs because of their purity. When water was difficult to collect, loggers developed the spring by excavating a chamber, lining it with planks or masonry, and diverting drainage around the excavation.

Ditch: Some residential complexes feature ditches that delivered fresh water for consumption and other uses. Such ditches are minor excavations and may descend through the camp at a steep pitch.

Domestic Refuse Dump: In camp, loggers threw their household refuse downslope from boardinghouses and cabins. Over time, they created substantial concentrations of food-related and other household artifacts such as food cans, fragmented bottles and tableware, and personal articles.

Domestic Refuse Scatter: A disbursed scatter of domestic refuse, usually extending downslope from a residential feature.

Privy Pit: Privy pits were excavated in the ground to receive waste from privies. When a pit became full, camp residents relocated the privy building, topped the depression off with domestic refuse, and shoveled over a soil cap. The cap subsided as the pit contents leached away and decayed, creating a depression usually less than 6' in diameter. Pits often feature backdirt downslope, some domestic refuse in the interior, and ashy soil. The pit may be surrounded by more refuse and footers for the privy building.

Root Cellar: Residences and businesses that handled high volumes of perishable food had root cellars for storage. Root cellars, often mistaken for dugouts, were excavated into the ground near their associated buildings. Walls usually made of rocks, logs, or lumber retained earthen sides and a roof covered with more earth. Because root cellars were not residences, they usually offer few domestic artifacts and lack stovepipe ports.

Shop: Because logging camps were centers of operations, they usually included a shop where workers maintained tools and fabricated hardware. The shops were like those at sawmills, described above.

Shop Platform: See description above with sawmill features.

Shop Ruin: See description above with sawmill features.

Shop Refuse Dump: See description above with sawmill features.

Spring Box: A spring box was a small enclosure built over a developed spring. The structures had plank walls, often a masonry or concrete chamber, a roof, and an entry door.

Stable: Because logging camps were centers of operations, they usually included a stable to house draft animals. See description above with sawmill features.

Stable Ruin: See description above with sawmill features.

Transportation System Feature Types

Corduroy Road: Erosion and mud created by logging traffic often rendered roads impassable in wet areas. In response, logging outfits paved wet sections with available resources, which in forests, were trees. They laid a tight series of logs 90 degrees across the road, and although the rough surface was unpleasant for pedestrians and wagons, it eased the task of skidding logs.

Road: When not on a railroad, sawmills relied on wagons to ship their lumber to market. Wagons required roads, which were usually 7' to 12' wide and lined with cobbles loosened by traffic.

Skid Trail: Skid trails were ruts and furrows that muleskinners created by dragging logs out of the forest with draft animals. The trails descended downslope along paths of fewest obstacles, and usually ended at a sawmill, loading station, or tie collection point. Over time, traffic eroded the trails into channels less than 8' wide. Trails descending steep slopes were also known as timber slides.

Timber Slide: A timber slide was another name for a skid trail, described above.

Loading Station and Tie Collection Point Feature Types

The types of features specific to loading stations and tie collection points are listed below. By nature, the stations and collection points were centers of transportation networks that included skid trails, roads, and sometimes flumes. Related aspects are described below under Transportation and Flume features.

Building Platform: Loading stations and tie collection points occasionally featured utilitarian buildings for storage or shelter. When removed, the building often left an earthen platform approximating its footprint.

Building Ruin: The collapsed remnants of a utilitarian building or storage shed.

Hoisting Derrick Foundation: Hoisting derricks were primitive cranes, and lumber companies occasionally erected them at loading stations to move cumbersome logs. A derrick had a mast timber, a boom timber, and a winch, all on a turntable. The mast was nearly vertical, fixed to the turntable, and guyed with ropes. The boom hinged at the mast base, and it was raised and lowered with ropes. The hoisting cable lifted the logs, and it passed from the winch through pulleys on the mast and over the boom. The turntable was proportional to the size of the derrick, and the ones for logging ranged from 2'x2' to 5'x5' in area. A foundation slightly larger in size anchored the turntable. The foundation was typically made with short log stringers bolted to more logs buried with rock ballast.

Loading Frame: A structure made of logs or timbers that allowed teamsters to roll raw logs from a stockpile onto their wagons for shipment to a sawmill. Workers usually built the frame on a slope adjacent to and above a road. Most were around 12' wide, 4' high, and constructed with log cribbing. Long-term versions consisted of milled timbers. Tie collection points with high volumes of traffic also had loading frames, although rare. The frames were around 6' wide and 4' high.

Loading Platform: Loading platforms were similar in shape, size, and location to loading frames. The difference was that platforms consisted of earth usually retained by log cribbing.

Log Stockpile: A collection of cut logs staged for transportation.

Loop Road: Because wagons had great difficulty turning around and backing up, loading stations featured loop roads that directed a one-way flow of traffic past the loading frame. The teamster could pull alongside, transfer the logs, and continue around the loop.

Refuse Dump: Loading stations used for prolonged periods of time also served as maintenance centers where loggers repaired equipment and manufactured items. They threw hardware, structural materials, and other refuse into piles along the edges of the clearing.

Shop: Large loading stations and tie collection points also served as bases of logging operations. Some featured shops where loggers serviced tools and fabricated hardware. For a description, see sawmill features above.

Shop Platform: See sawmill features above.

Shop Ruin: See sawmill features above.

Stable: Occasionally, loading stations and collection points included stables to house draft animals. See sawmill features above.

Stable Ruin: See sawmill features above.

Tie Stack: Most tie collection points lacked transfer structures. Instead, workers neatly stacked their ties for shipment to a railroad. They crosshatched layers of ties as high as around 8' on log bolsters.

Tie Stockpile: In some cases, tie producers chose to stockpile finished ties in arrangements other than crosshatched stacks. They laid rows over a platform or log bolsters, or simply dumped them in a jumbled pile on the ground.

Winch Anchor: Some logs were too heavy and large to be dragged by draft animals. In such cases, lumber companies substituted donkey winches and reeled the logs to loading stations. Prior to the 1920s, the winches were steam-powered, and afterward, driven by gasoline engines. In either case, the winches were self-contained on a bedplate that rested on the ground. Cables lashed to several anchor points held the winch in place.

Flume Feature Types

Diversion Dam: A diversion dam was a structure that shunted stream flow into the headgate of a flume. The dam was intended to raise the water to headgate level but not entirely block the stream. Dams were vernacular in construction and design and usually consisted of log cribbing cells filled with gravel, although some were made of lumber.

Flume: A flume was an engineered structure that carried water, logs, and lumber from loading stations at the head down to receiving stations at the tail. Flumes ranged from 2'x4' in width and as high, and were hundreds of feet to

miles in length. Box flumes featured plank walls and a floor bound on all sides with box-frame sets. V flumes had plank walls joined at the bottom. Both rested on a subframe of cross-members and timber stringers.

Flume Bed: Where possible, lumber companies built flumes directly on the surface of prepared earthen beds graded across slopes. The beds were flat, 2' to 6' wide, and descended at gentle angles to maintain a flow from head to tail.

Flume Ruin: The structural remnants of a flume.

Headgate: The top end of a flume featured a headgate to admit or shut off the flow of water. A headgate typically featured plank slats or a sliding steel panel in tracks.

Loading Frame: Loading frames allowed workers to stockpile logs and lumber at a loading point and gently drop the materials into the flume. Frames consisted of either log cribbing or milled timbers.

Loading Platform: A loading platform performed the same function as a loading ramp, consisting of an earthen pad retained by log cribbing.

Storage Frame: When workers retrieved lumber and logs from the tail of the flume, they stacked the material on a frame to dry it while in storage. The frame consisted of either logs or lumber.

Storage Platform: A storage platform performed the same function as a storage frame, consisting of an earthen pad retained by log cribbing. Workers elevated the lumber or logs above the ground on bolsters.

Trestle: Trestles carried flumes over substantial drainages and other low points. Short trestles may have consisted of little more than pairs of log posts supporting the flume's subframe. Long or high trestles featured timber piers, footers, and stringers supporting the subframe.

Trestle Remnant: The collapsed ruins of a trestle. Usually, footers, posts, and abutments remain extant.

Section B 3: High-Altitude Agriculture Property Types and Registration Requirements

Section B provides descriptions of and registration requirements for the historic property types associated with homesteads, farms, and ranches in the I-70 corridor. In 1999, Thomas H. and R. Laurie Simmons (Front Range Research Associates) produced *Historic Ranching Resources of South Park, Colorado*, a Multiple Property Documentation Form for evaluating historic agricultural resources in Park County.⁶⁸⁷ The discussion of property types and subtypes for the I-70 corridor follows the Simmons' precedent because of similarities in theme and resources. Itemized descriptions of archaeological, structural, and architectural features have been added to refine the interpretation of the historic resources expected in the corridor. Because the movement of goods, people and animals was paramount to successful agriculture, all the Property Types except for the simplest homesteads include road segments. To describe and evaluate contributing segments, consult Appendix VI in *National Register Bulletin 16A: How to Complete the National Register Registration Form*, available at History Colorado and the National Park Service.⁶⁸⁸

The following property types and subtypes are developed in this section:

- Homestead
 - Residential Buildings
 - Homestead Support Facilities
 - Livestock and Crop Storage Facilities
- Ranch
 - Residential Buildings
 - Ranch Support Facilities
 - Livestock and Crop Storage Facilities
- Farm
 - Residential Buildings
 - Farm Support Facilities
 - Livestock and Crop Storage Facilities
- Agricultural Rural Historic Landscape

PROPERTY TYPE: HOMESTEAD

A homestead can often be characterized as a primitive agricultural settlement arranged on a tract of previously undeveloped rural land, usually in a frontier environment. An individual could secure a single homestead plat of 160 acres (quarter-section), and as many as four families settled adjoining plats and built their houses for mutual assistance. In some cases, logging

⁶⁸⁷ Simmons, Laurie R. and Simmons, Thomas H. *National Register of Historic Places, Multiple Property Documentation Form: Historic Ranching Resources of South Park, Colorado* Denver, CO, 1999, Front Range Research Associates.

⁶⁸⁸ *National Register Bulletin 16A: How to Complete the National Register Registration Form*. National Park Service, 1997 [1977].

companies and ranchers convinced individuals to plat homesteads and convey the land to their operations not for agriculture, but instead for the natural resources. These plats do not qualify as a Homestead property type.⁶⁸⁹

Homesteads depended on agriculture for subsistence and income, and by definition, produced goods in limited quantities. In the Clear Creek and Blue River drainages, the high altitude climate limited agriculture to livestock such as cattle, hogs, and fowl, and cold-weather crops including hay, root vegetables, and greens. The climate along the Eagle and Colorado rivers was gentler and allowed homesteaders to produce a greater variety of crops. When agriculture became commercial in scale, the homestead can be redefined as a ranch or farm. Homesteaders sometimes used their complexes as bases for other businesses to supplement income. Blacksmithing, horseshoeing, and woodcutting were common. When on popular routes, homesteaders advertised their establishments as stage stops where travelers could billet overnight. Some homesteads also originated formal settlements, exemplified by the evolution of John Bocco's establishment on the Eagle River into the town of Minturn.

Homesteads consisted of much more than a primitive residence in a frontier setting. They also had facilities to support daily life and agricultural operations and fields for crops and livestock. The facilities for living included a well or spring, root cellar, outhouse, and an area where the residents disposed of solid waste. To support agriculture, the homesteader maintained a blacksmith shop, barn, stable, corral, feed trough, and additional water sources. Most of these improvements were buildings and structures clustered around the residence, while those for livestock were far enough away to minimize vermin. Agricultural fields surrounded the homestead complex, and those for crops were fenced, plowed, and the cobbles removed. Irrigation ditches provided water, and the homesteaders threw the cobbles into piles at the field corners or along the downslope edges.

Because homesteads were built in open territory, or by individuals with limited resources, the buildings tended to be small and simple, consisting of local materials. Logs were a universal resource throughout the I-70 corridor, although some settlers also used native stone. Lumber became widely available by 1873 in Clear Creek drainage, 1880 in Blue River drainage, and 1886 on the Eagle and Colorado rivers. Concurrently, homesteaders turned to frame construction for principal buildings, although many continued to use logs into the 1910s. Corrugated sheet iron became popular for roofs by around 1900, regardless of location.

Today, few homesteads appear exactly as they did when founded. Many deteriorated following abandonment, and those continually occupied likely evolved over time to serve changing needs. Although core buildings such as the residence and barn may date to the original time of settlement, homesteaders added facilities during continued occupation. Thus, buildings and structures often feature a variety of construction materials, methods, and workmanship. Many complexes have suffered demolition by neglect, or their structures and buildings removed, nevertheless leaving distinct archaeological evidence. When the evidence clearly represents the homestead and its history, the assemblage may qualify for the NRHP as an archaeological expression of a homestead.

⁶⁸⁹ Defebaugh, James Elliott *History of the Lumber Industry of America* Chicago, IL: The American Lumberman, 1906, 387; Steen, Harold K. *The U.S. Forest Service: A History* Seattle, WA: University of Washington Press, 1976, 8; Wroten, William H. *The Railroad Tie Industry in the Central Rocky Mountain Region, 1867-1900* University of Colorado, CO: 1956, 192.

Homestead Property Subtypes

Property Subtype: Homestead Residential Building: Early settlers erected three general types of homestead residences: dugouts, log cabins, and small houses of wood-frame construction. These three types are described below. All served a similar function as a center of life at the homestead. The dwelling was where settlers slept, cooked, dined, attended to domestic duties, and conducted business. Because the I-70 corridor was generally settled from east to west, homestead residences in Clear Creek County date from circa 1860 to 1880, while those in the Blue River Valley in Summit County date from circa 1865 to 1890, and those in the Eagle and Colorado River valleys date from circa 1870 to 1920. The oldest, most rudimentary, residences are therefore likely in the Clear Creek drainage, with newer, more elaborate homestead dwellings located on the western side of the Continental Divide. Nearly all residences can be expected to be vernacular in form and construction. Those in Clear Creek and Summit counties are likely to be built from locally available materials and heavily influenced by the local climate, topography, availability of water, and other physical characteristics specific to the region. Residences in the Eagle and Colorado River Valleys, conversely, are more likely to be built with dimensional lumber and manufactured materials, brought to the region by the railroad and purchased from local suppliers. The newer dwellings are also more likely to display stylistic influences and ornamental details, disseminated by pattern books and popular architectural magazines. Character-defining features of homestead residences are summarized at the subsection's end.

Dugout: Dugouts were the earliest and most primitive homestead residences. They were usually erected by impoverished individuals who had little time and few resources when initially developing homestead claims. Settlers almost always considered dugouts to be temporary residences, replacing them when they had enough money and materials.

The settler excavated a deep incision in a slope, smoothed the earthen sides and rear as walls, added a façade front, and installed a low-angle roof over a log ridge-beam. Excavating a chamber out of a slope simplified construction, minimized building materials, and afforded protection from the elements once the dugout was complete. Dugouts may appear similar to root cellars, although they possess distinguishing characteristics that reflect domestic occupation instead of cold-storage. First, dugouts are rectangular and at least 12'x15' in area and 6' high inside, which provided sufficient living space. Second, the façades featured frame doorways, windows, and roof extensions sheltering the entry. The windows may have been without glazing, and doors were often made of wood planks. Third, homesteaders cooked food in their dugouts, usually either in open hearths or on cast-iron stoves. Thus, dugouts usually had a stone chimney or stovepipe port in their roofs for the stove. Last, dugouts feature domestic artifacts left from residential occupation.

Because dugouts were typically built into hillsides, their façades were a primary element above grade. The façade consisted of locally harvested logs, rocks, or lumber when available. Most of lumber was rough-cut and true in dimension, instead of slightly smaller than designated stock. When homesteaders used logs for the façade, they treated them in three ways. The simplest were to leave them round with bark intact. Another was to peel the bark away. The third was to hand hew the logs into timbers with an axe or adz. The logs were assembled into the wall with saddle- or square-notched corner joints. Gaps between the logs were chinked with

combinations of small stones, sand, straw, animal hair, moss, newspapers, bits of wood, and other available materials. Split strips or rough mortar or clay held the chinking in place. Sill logs were placed either directly on the ground, or on a dry-laid stone foundation designed to keep the dugout from settling.

Homesteaders usually covered their dugouts with front-gabled or barrel-shaped roofs, sometimes referred to as boxcar roofs. Regardless of era, most roofs were based on similar elements. A center ridge-beam extended lengthwise across the dugout, and depending on the structure's size, may have been flanked by additional beams. Rafters and plank decking often supported sheet-iron cladding or earth. Settlers often substituted closely spaced logs for decking.

The earliest entry doors were made of planks split from hand-hewn, squared logs. Somewhat later, entry doors, door frames, and window frames, were made of rough-cut lumber or mill-slabs, which were the rinds of trees cut away at a local sawmill. Homesteaders preferred mill-slabs because lumber companies considered them waste and gave the material away. Early in an area's history, glass was very costly if not difficult to obtain. Thus, homesteaders often substituted wax paper or white cloth for proper glazing.

Cabin: Homesteaders constructed dugouts primarily as temporary shelters with an understanding that they would be replaced by a permanent residence as time and money allowed. The earliest type of permanent residence was a log cabin, followed by progressively more elaborate houses of wood-frame construction. As explained in Section A, dugouts, early homestead cabins, and frame houses were vernacular, as well as traditional. Their construction was influenced by local materials, the climate, topography, soil conditions, availability of water, and other physical characteristics specific to the region. Cabins were traditional because they were a product of the construction methods and techniques employed by their builders, passed down through generations, and adapted to the Colorado frontier.

Later in the homesteading movement, settlers constructed their dwellings with a combination of indigenous materials, dimensional lumber, and manufactured supplies. Early homestead residences also reflected the needs and visions of their builders. For example, an unmarried homesteader did not require as large or elaborate a dwelling as a homesteader with a family. Such cabins were vernacular and rarely conformed to an architectural style, but some were stylistically influenced.

Homestead cabins follow some continuity in architectural materials, workmanship, and form. Prior to 1900, homesteaders extensively used hand-hewn or peeled logs, and stone masonry less often. Afterward, homesteaders increasingly used lumber with timeframe specific to region. Homesteaders assembled cabin walls with square, saddle, or V-notch joints, and laid sill logs as foundations.

Log cabins may be categorized by an architectural terminology pertaining to their core plan, roof type, materials, door and window placement, number of rooms, and ancillary features such as porches. Most cabins were rectangular in plan with a gable roof and featured either a single room (single-pen cabin) or two rooms (double-pen cabin). Rectangular, double-pen cabins may be subdivided into the Shotgun and Hall-and-Parlor plans. Gabled-L and Gabled-T type cabins featured several rooms in L-shaped or T-shaped floorplans covered by cross-gabled roofs. The following list summarizes common homestead residence types, and all are described individually at the subsection's end, as well as Section B 8.

- Single-Pen Cabin: Rectangular, front-gabled roof, one room.
- Double-Pen Cabin: Rectangular, front-gabled roof, two rooms.

- Shotgun Cabin: Rectangular, front-gabled roof, one-room wide, two or more rooms deep.
- Hall-and Parlor: Rectangular, front-gabled roof, two rooms with one larger than the other.
- Gabled-L: L-Shaped, with a cross-gabled roof, a parlor in the side-gabled wing, a bedroom in the front-gabled wing, and kitchen at rear.
- Gabled-T: T-Shaped, cross-gabled roof, usually with a side-gabled front wing and a centered rear gable. An enclosed shed-roofed rear porch often fills one of the voids formed by the T-shaped plan.

Wood-Frame House: Homesteaders built frame residences primarily after railroads increased availability and decreased costs of manufactured materials. Timeframe varied according to corridor segment history. Frame residences were based on a dimensional lumber skeleton, sided on the exterior with sheathing boards, and clad with lapped horizontal wood or horizontal weatherboard siding. Exterior walls were sometimes re-clad with rolled asphalt, particularly on the windward side to provide additional protection from the elements.

Homesteaders erected their frame houses on several types of foundations, almost always arranged on cut-and-fill earthen platforms. The simplest and least expensive were impermanent footers of logs, timbers, or dry-laid rocks. The footers outlined the building footprint and often included interior pilings or dividers for center support. After a house was removed, it may be represented by the above archaeological features.

Lasting foundations were made of native stone, poured concrete, and by the 1910s, cinderblocks. Early stone foundations were often later coated with concrete pargeting. Poured concrete foundations consisted of cement, sand, gravel and water poured into plank forms, which left patterns from the wood grain and joints when dismantled. Hollow cinderblocks were usually purchased commercially; although some homesteaders made their own by pouring concrete into block-shaped molds.

Frame homestead houses were covered by front-gabled, side-gabled, cross-gabled, or hipped-roofs, with 1" plank decking on 2" thick rafters. The decking was clad with shingles, sheet metal, rolled asphalt, or corrugated sheet iron. The rafter ends were exposed beneath the eaves, covered by a fascia board, or boxed. A stone or brick chimney, or stovepipe, typically extended up from the rear of the house. Door and window placement depended on the core plan.

Many frame houses were based on the same forms and plans as the log cabins described above, as well as other types. Those that may exist in the I-70 corridor include the L-Shaped plan, T-Shaped plan, I-House plan, Hipped-Roof Box type, Pyramid Cottage, Foursquare type, Classic Cottage, and Bungalow type. The following list summarizes the additional types, and all are described individually at the subsection's end, as well as Section B 8.

- I-House: Enlarged version of Hall-and-Parlor plan. The design is two-rooms wide, one-room deep, with a central passage or hallway separating the rooms.
- Hipped-Roof Box: a simple rectangular (nearly square) plan covered by a hipped roof. The type is usually slightly shorter across the façade than the length. The core plan was often modified by an enclosed, shed-roofed rear mud porch.
- Pyramid Cottage: a small, usually square version of the Hipped-Roof Box house.
- Foursquare House: a 2½-story version of the Hipped-Roof Box.
- Classic Cottage: a stylized, 1½-story version of the Foursquare house. Classic Cottage houses are usually of brick or stone masonry, and frame examples are rare.
- Bungalow: this type features low, horizontal lines; low-pitched, gabled or hipped roofs; often with knee braces in the upper gable ends. Facades are dominated by a broad stairway leading to a full or nearly full-width front porch. Porch roofs are supported by battered pedestals, topped by large, square-post piers, creating a heavy, horizontal emphasis.

Property Subtype: Homestead Support Facilities: Homestead residences were too small and primitive to enclose all the functions that supported daily life, and they lacked sanitation. Settlers built exterior facilities around the residence to provide water, heating fuel, food storage, and waste disposal. The support facilities were important because they administered to the necessities of frontier life. Outbuildings enclosed some facilities such as wood storage or a spring, and structures and objects served other functions.

In many cases, support facilities decayed due to neglect or were intentionally dismantled, leaving material evidence in various states of preservation. When reduced to manifestations that are buried or on ground-surface, the facilities can be categorized as archaeological features. Such remnants may be evaluated as contributing elements of the homestead complex or for individual eligibility. Below is a list of the most common support outbuildings. Their character-defining features, associated facilities, and archaeological manifestations are detailed at the subsection's end.

- **Blacksmith Shop:** A building where a settler fabricated and maintained tools and hardware. Simple shops usually featured a blacksmith forge, workbench, and possibly hand-powered appliances such as a drill press or lathe.
- **Privy:** A building that served as a toilet facility. Privies stood over pits, were around 4'x5' in area, and featured a bench with a cut-out as a toilet seat.
- **Root Cellar:** Root cellars were independent structures used for food storage. They often manifest as small dugouts with earthen roofs and façades of rocks, logs, or lumber.
- **Spring House:** When possible, settlers relied on springs for drinking water because of their purity. The settler erected a small masonry or frame enclosure over the spring to keep out debris, and provided an outlet for overflow water. The enclosure usually had a gabled or shed roof.
- **Storehouse:** Storehouses were small buildings of lumber or logs for the storage of goods other than food.
- **Woodshed:** Because wood was a primary heating and cooking fuel, a supply kept dry in a shed was critical. Sheds were small, of log or frame construction, and may have been open.

Property Subtype: Homestead Livestock and Crop Storage Facilities: Homesteads had outbuildings, structures, and objects that supported agricultural operations. These facilities were important because they directly affected the settlers' livelihood, allowing them to realize income if not merely surviving. Some facilities were specific to livestock, and they were usually clustered together. Because homesteaders practiced agriculture on a limited scale, the support facilities were smaller and simpler than those on ranches and farms. A common design included a stable, chicken coop, rabbit hutch, tack shed, and water source clustered around a barn and corral. Facilities for crops were close to the fields and included a grain shed and a potato cellar.

In many cases, the support facilities decayed due to neglect or were intentionally dismantled, leaving material evidence in various states of preservation. When reduced to manifestations buried or on ground-surface, the facilities can be categorized as archaeological features. Such remnants may be evaluated as contributing elements of the homestead complex, or for individual eligibility. Below is a list of the most common livestock and crop outbuildings, with character-defining features and archaeological remnants described at the subsection's end.

- **Barn:** A barn was a multipurpose building that housed fodder, tack, agricultural equipment and tools, and draft animals. Depending on location and era, settlers used logs, lumber, or a combination for walls and roofs. Large barns had at least lumber roofs, if not lumber walls. Most were drafty and had wide doorways and lofts.
- **Chicken Coop:** Chicken coops were usually small, made of lumber, divided into shelves, and had one open face.

- Grain Shed: Settlers erected grain sheds to store grain in bulk form. They were shed or gabled in form and of frame construction with plank siding on the interior face. Inside, the shed was divided for different grain types.
- Potato Cellar: Potato cellars, similar to bunkers, were countersunk into the ground, lagged on the interior with planks, and covered with earth. The cellars were at least 8'x10' in area with broad doorways.
- Rabbit Hutch: Rabbit hutches were small sheds elevated on legs with an open face of chicken wire. The interior was divided into several cells for rabbits.
- Stable: Horses were a principal means of transportation around ranches, and they were housed in stables separately from common livestock. Stables were similar to but smaller than barns. Their interiors were divided into stalls with feed troughs, and lofts for the storage of fodder.
- Tack Shed: A small building in which settlers stored tack and hardware for managing animals. Tack houses were usually shed in form and of logs or lumber. The interior should feature nails and hooks for hanging tack and shelves for tools.

Homestead Significance

As historic resources, homesteads were associated with a variety of important trends and historical patterns. These are summarized as the NRHP Areas of Significance below, including Agriculture, Architecture, Commerce, Exploration/Settlement, Industry and Politics/Government.

Period of Significance must be considered when determining the historical importance of homesteads. Although the general Period applicable to agriculture in the I-70 corridor spans 1860 to 1960, each corridor segment had slightly different years. The relevant Period of Significance for homesteading in Clear Creek County spanned 1860 to 1880, and in the Blue River drainage from 1865 through 1890. Along the Eagle and Colorado rivers, homesteading was important from 1870 until 1920. Level of significance was local.

Area of Significance: Agriculture: Homesteading was an important agricultural institution in the central mountains for several reasons. The earliest homesteaders adapted known agricultural practices to the rigorous mountain climate. Through trial and error, they determined which crops would grow, when to plant and harvest, and how to keep animals. Settlers planned property improvements according to their perception of efficiency, influenced by tradition, experience, and environmental constraints. They considered the needs of residential occupation, animal husbandry, cultivation, and irrigation. For individual structures, the settlers combined known construction methods with local building materials for functional facilities. The designs were often informal and vernacular while meeting financial budgets and the homesteader's needs. Cumulatively, the body of knowledge became a foundation for ranching and farming, which succeeded homesteading.

Area of Significance: Architecture: Homesteads were important in the Area of Architecture for several reasons. Settlers adapted familiar building designs and methods of construction to the frontier conditions of the Rocky Mountains. Some of the conditions included topography, natural landscape features, local climate, and available building materials. In many cases, tight economic constraints influenced how settlers adapted designs and materials. As a result, homesteaders contributed to existing patterns of functional and yet cost-effective rural frontier architecture.

Area of Significance: Commerce: Homesteaders were an important link in the early frontier economy of the central mountains. They produced food for miners, loggers, and their animals,

selling these materials to local markets. In so doing, homesteaders pioneered the agricultural segment of mountain commerce and contributed to the growing complexity of regional economies.

Area of Significance: Exploration/Settlement: Homesteaders were among the first permanent settlers in the central mountains. In the Clear Creek and Blue River drainages, they arrived within a short time after prospectors and miners, establishing a permanent Euro-American presence. Homesteaders altogether pioneered several sections of the Eagle and Colorado rivers and settled in advance of other forms of industry. In so doing, homesteaders anchored permanent settlement. Homesteads fostered the growth of some communities in the corridor. The Floyd homestead on Floyd Hill, Clear Creek County, and an establishment on the Blue River, Summit County, served as important stations on key road networks. These and other homesteads provided support to travelers who then settled the corridor. Individual and groups of homesteads also were the seeds for permanent towns such as Dillon, Dotsero, Eagle, and Minturn.

Area of Significance: Industry: Although homesteads were not voluminous producers of agricultural goods, they nonetheless played an important role in the agricultural industry. Collectively, homesteads were the foundation of agriculture as a business in the mountains, being among the earliest local producers to sell vegetables and fodder to mining communities in Clear Creek and Summit counties, as well as Leadville and Aspen. The industry became one of the most important economic sectors with its evolution into farming and ranching.

Area of Significance: Politics/Government: Homesteads were physical manifestations of federal policies designed to encourage settlement of the West. The Homestead Act of 1862 provided title to 160 acres after five years occupation and payment of application fees. The Timber Culture Act of 1873 allowed settlers to buy 160 acres for \$1.25 per acre if they planted one-quarter with trees and maintained them for ten years. The Desert Land Act of 1877 conveyed 640 acres for \$.25 per acre if the claimant proved irrigation within three years. All three acts fostered homesteading as a movement, resulting in the settlement of entire regions. Collectively, the homesteaders established a permanent Euro-American presence and economic foundation in those regions.

Homestead Registration Requirements

To qualify for the NRHP, homesteads must meet at least one of the Criteria listed below and possess adequate physical integrity to represent the Property Type and convey its significance.

Criterion A: Resources eligible under Criterion A must be associated with at least one Area of Significance noted above as well as a contribution to a broad pattern of history.

Criterion B: Homesteads may be eligible under Criterion B provided an association with the life of an important person significant in our past. The associated resource must retain physical integrity relative to that person's productive life. A brief biography is necessary to detail the individual's significant contributions. In some cases, important people filed homestead plats but did not occupy the property and instead rented or leased the land out. Such an association does not meet the registration requirements outlined here. The individual of note must have been

present on-site. Applying Criterion B is complex, and *National Register Bulletin 32: Guidelines for Evaluating and Documenting Properties Associated with Significant Persons* can provide further guidance.

Criterion C: Homesteads may be eligible under Criterion C if the buildings are good representative examples of significant architectural types or styles. Similarly, a homestead may be eligible if the structures and objects are good representative examples of significant types or designs. The overall assemblage of buildings, structures, and archaeological features may also be a sound example of design, agricultural practices, and land use specific to homesteads. Discernible patterns of cultivation, irrigation, or animal husbandry may be expressed as a rural historic landscape. In such cases, the homestead may qualify as the historic landscape property type discussed below.

Criterion D: Buildings, structures, and land use modifications often left archaeological evidence when removed or abandoned. When this evidence clearly represents the homestead during the Period of Significance, the site retains integrity on an archaeological level. For archaeological remains to constitute integrity, the material evidence should permit the virtual reconstruction of the homestead complex and land use patterns. If archaeological features and artifacts offer important information regarding homestead design and operation, settlement patterns, or aspects of homesteader demography and lifestyle, then the site may qualify under Criterion D.

If the homestead possesses building platforms, privy pits, and refuse dumps, testing and excavation of these buried archaeological deposits may reveal important information regarding agricultural lifestyle and demography on the frontier. Areas of inquiry may include but are not limited to diet, health, gender and family, ethnicity and cultural practices, socioeconomic status, agricultural practices, and animal husbandry.

Homesteads must possess physical integrity relative to the Period of Significance for its region. Few homesteads will appear as they did when initially established. Some were occupied for extended periods and modified over time. Such homesteads represent the evolution and, most likely, the expansion of agricultural complexes. Most homesteads were, however, abandoned when the settlers sold the land or moved to superior complexes. These resources tend to be in advanced states of decay and can qualify as archaeological sites.

Many of the seven aspects of historic integrity defined by the NRHP may apply to homesteads, although not all need be present. Integrity must be sufficient to convey the Property Type and its significance. To retain integrity of *location*, a structure or building should be on the homestead, although some buildings and structures may have been moved short distances from their original place of construction. For a resource to retain integrity of *design*, the homestead's material remains must convey the organization and planning of the residential complex, the support facilities, cultivation, and animal husbandry. To retain the aspect of *setting*, the homestead complex and the surrounding agricultural land must not have changed a great degree from its period of occupation. In terms of *feeling*, the homestead should convey a perception of frontier settlement and agriculture from a historical perspective and in the context of regional land use today. Integrity of *association* exists where structures, buildings, and archaeological features convey a connection between homesteading and a contemporary observer's ability to discern the historic activity.

PROPERTY TYPE: RANCH

A ranch was a business enterprise that specialized in breeding, raising, and grazing livestock in commercial numbers. Many ranches began as homesteads, but when they crossed the threshold into commercial livestock, they became ranches by definition. Isolation in primitive conditions required operations to be self-sufficient to some degree, and they grew produce and also feed for livestock. Given this, ranches commonly featured some attributes characteristic of the farm property type defined below. Most ranches in the I-70 corridor worked with cattle, which were infrastructure-intensive, and some also kept sheep that had simple needs.

The size and content of a ranch was a function of its business model, era, and location. Early ranches run by families tended to be small with only the most essential buildings and structures, while companies invested capital in specialized facilities for large numbers of workers and livestock. Many ranches that started small grew over time, and their complexes tend to include a spectrum of buildings and structures sequential in age.

In form, ranches followed traditional agricultural land use patterns, consisting of a cluster of residential buildings, support structures, and other facilities on expansive tracts of rural land. Most were arranged according to variations of concentricity. The residential buildings formed a core, and the support facilities were scattered around the outside. This complex was center to a band of maintained, cultivated, and fenced fields, surrounded in turn by open range land, usually publically owned. Large ranching outfits erected satellite support facilities in distant range land, including corrals, wells, hay barns, and line camps.

Like homesteaders, ranchers sited their residences near sources of water, preferring springs because of their purity. Small ranches usually had a substantial house for the family and a cabin for several cowboys. Large ranches added a bunkhouse and cookhouse for a workforce, and even a guesthouse for visiting investors. Nearly all ranches had other facilities supporting daily life such as a well or spring, root cellar, smokehouse, outhouses, and an area where the residents disposed of solid waste.

Ranch complexes always included facilities that supported the business of tending livestock. Outfits arranged barns, stables, corrals, loading chutes, and feedlots in connected systems to move, segregate, and feed animals. These distinguishing characteristics tend to be large in scale to accommodate livestock in commercial numbers. Associated support facilities typically included a blacksmith shop, tack shed, and water system, however primitive. In the interest of self-sufficiency, ranching outfits built chicken coops, rabbit hutches, and milking sheds and maintained produce gardens.

Era and location influenced the materials, construction, and sizes of individual buildings and structures. Buildings erected when an area was in a frontier state were often simple, small, and made of local materials. Logs were universal throughout the I-70 corridor, and some ranchers also used native stone. Lumber became widely available by 1870 in Clear Creek drainage, 1880 in Blue River drainage, and 1886 on the Eagle and Colorado rivers. Ranchers then transitioned into frame construction for principal buildings, although many continued to use logs into the 1910s. Corrugated sheet iron became popular for roofs by around 1900.

At present, few ranches appear exactly as they did when founded. Many have been continually occupied, evolving over time to suit changing needs and land use patterns. Although

core buildings such as the residence and barn may date to the original time of settlement, property owners added and removed facilities and outbuildings. Thus, buildings and structures may feature a variety of construction materials, methods, and workmanship. Some complexes have suffered demolition by neglect, or their structures and buildings removed altogether, nevertheless leaving distinct archaeological evidence. When the evidence clearly represents the ranch and its history, the assemblage may qualify for the NRHP as an archaeological expression of a ranch.

Ranch Property Subtypes

Property Subtype: Ranch Residential Building: The primary residential building at a ranch was the ranch house, where the family slept, cooked, dined, attended to domestic duties, conducted their livestock business, and otherwise interacted as a family. The kitchen was a center of life, and it was usually large and well-appointed. At large-scale company ranches, some houses had quarters for visiting investors and a dining room for hands.

Most ranches also had cabins performing one of several functions. Company ranches sometimes maintained a cabin as a guesthouse, which tended to be small but well-appointed. Ranchers also allotted cabins or bunkhouses for cowboys and ranch hands who lived communally. Such cabins housed several individuals in shared bedrooms and a common room. Companies with large operations employed workforces that were too numerous for simple cabins. Instead, the cowboys and hands lived in bunkhouses featuring small bedrooms, a common room, and sometimes a kitchen. The workers usually dined together and shared sleeping space.

Ranch houses went through a similar evolution as homestead houses. Further, many early ranch houses were transitional residences originally built for a homestead. These were typically small, single-story, rectangular-shaped cabins of log or wood frame construction (as described above under the Homestead property subtypes). As ranches became economically viable enterprises, transitional dwellings were replaced with more substantial 1½-story, Gabled-L, and Gabled-T shaped houses and eventually by recognizable types such as the I-House, Hipped-Roof, Foursquare, and Bungalow (see below).

Early ranch houses were vernacular, and their form and construction was influenced by a number of factors. They were not architect-designed or built by professional contractors, and instead were influenced by the perceived needs and abilities of their owners. Construction was affected by the climate, topography, soil conditions, availability of building materials, and other physical characteristics specific to a region. Ranch houses were also a product of economic factors and of time by the dissemination of popular building materials, techniques, styles, and details. Early ranch houses were traditional because they reflected the construction techniques, traditions, and cultural influences passed down through generations, brought west by early ranchers, and adapted to the Colorado frontier.

After commercial lumber became available, ranch houses were predominantly built of frame construction, and less often, of brick or stone. Although many were still vernacular in form, they displayed stylistic influences and ornamental details reflecting the ranchers' individual tastes and traditions, and increasingly, the architectural fashions then in vogue.

By the 1890s, the spread of architectural styles and ornamental details, popularized by architectural pattern books and magazines, increasingly influenced the appearance of ranch houses. House plans and ornamental details became available through Sears, Roebuck &

Company and popular magazines such as *House Beautiful* and *Ladies Home Journal*. Around the same time, architectural publications such as the *Craftsman*, *Western Architect* and *Architectural Record* began promoting and distributing plans for specific types of houses, notably the Craftsman Bungalow. The influence of such publications, and the availability of manufactured materials, was first seen in ornamental details such as porch rails, columns, brackets, and other decorative elements, which were applied to vernacular residences. Newer houses tended to reflect the latest architectural trends and styles, although vernacular and traditional influences were common well into the twentieth century. Following is a list of common ranch house types. For greater detail, including character-defining features, see the list at the subsection's end, and Section B 8.

- Single-Pen Cabin: Rectangular, front-gabled roof, one room.
- Double-Pen Cabin: Rectangular, front-gabled roof, two rooms.
- Shotgun Cabin: Rectangular, front-gabled roof, one-room wide, two or more rooms deep.
- Hall-and Parlor: Rectangular, front-gabled roof, two rooms with one larger than the other.
- Gabled-L: L-Shaped, with a cross-gabled roof, a parlor in the side-gabled wing, a bedroom in the front-gabled wing, and kitchen at rear.
- Gabled-T: T-Shaped, cross-gabled roof, usually with a side-gabled front wing and a centered rear gable. An enclosed shed-roofed rear porch often fills one of the voids formed by the T-shaped plan.
- I-House: Enlarged version of Hall-and-Parlor plan. The design is two-rooms wide, one-room deep, with a central passage or hallway separating the rooms.
- Hipped-Roof Box: a simple rectangular (nearly square) plan covered by a hipped roof. The type is usually slightly shorter across the façade than the length. The core plan was often modified by an enclosed, shed-roofed rear mud porch.
- Pyramid Cottage: a small, usually square version of the Hipped-Roof Box house.
- Foursquare House: a 2½-story version of the Hipped-Roof Box.
- Classic Cottage: a stylized, 1½-story version of the Foursquare house. Classic Cottage houses are usually of brick or stone masonry, and frame examples are rare.
- Bungalow: this type features low, horizontal lines; low-pitched, gabled or hipped roofs; often with knee braces in the upper gable ends. Facades are dominated by a broad stairway leading to a full or nearly full-width front porch. Porch roofs are supported by battered pedestals, topped by large, square-post piers, creating a heavy, horizontal emphasis.

Property Subtype: Ranch Support Facilities: Houses and cabins served basic needs of ranch life, but were unable to fulfill all functions. Other facilities around the residences provided water, heating fuel, food storage, and waste disposal. The support facilities were important because they provided for necessities in addition to shelter and food preparation.

In many cases, support facilities decayed due to neglect or were intentionally dismantled, leaving material evidence in various states of preservation. When reduced to manifestations buried or on ground-surface, the facilities can be categorized as archaeological features. Such remnants may be evaluated as contributing elements of a ranch complex or for individual eligibility. Following is a list of the most common support outbuildings. Character-defining features, associated facilities, and related archaeological manifestations are at the subsection's end.

- Blacksmith Shop: A building where a settler fabricated and maintained tools and hardware. Simple shops usually featured a blacksmith forge, workbench, and possibly hand-powered appliances such as a drill press or lathe.
- Cookhouse: Companies erected cookhouses at large farms and ranches to feed workforces en masse. A cookhouse was a building, usually vernacular in form, with a large kitchen and dining area.

- Icehouse: Ranchers used icehouses both to store ice for warm months and as primitive refrigerators. Icehouses usually were countersunk into the ground and consisted of stone masonry for insulation, and they featured storage shelves.
- Privy: A building that served as a toilet facility. Privies stood over pits, were around 4'x5' in area, and featured a bench with a cut-out as a toilet seat.
- Root Cellar: Root cellars were independent structures used for food storage. They often manifest as small dugouts with earthen roofs and façades of rocks, logs, or lumber.
- Smokehouse: Ranch families preserved meat by jerking and smoking in small, insulated buildings. Windows were few, and the buildings had drying racks, chimneys, or stovepipes.
- Spring House: When possible, settlers relied on springs for drinking water because of their purity. The settler erected a small masonry or frame enclosure over the spring to keep out debris, and provided an outlet for overflow water. The enclosure usually had a gabled or shed roof.
- Storehouse: Storehouses were small buildings of lumber or logs for the storage of goods other than food.
- Woodshed: Because wood was a primary heating and cooking fuel, a supply kept dry in a shed was critical. Sheds were small, of log or frame construction, and may have been open.

Property Subtype: Ranch Livestock and Crop Storage Facilities: Breeding, grazing, and shipping livestock in commercial numbers required facilities specific to the industry. The most iconic were barns and systems of corrals, which are synonymous with ranching. Cattle had to be branded, dehorned, separated by breed or gender, and divided into groups for shipping. Systems of corrals were an interface between the range and ranch complex, allowing cowboys to accomplish these tasks. After driving a herd into a central corral, cowboys pushed them deeper into the system, and by opening gates, sent cattle to specific destinations such as a feedlot, dehorning cage, or loading chute. Most corral systems had water sources and feed troughs. Facilities for tending cattle and also horses were nearby and included tool sheds, tack sheds, and stables.

Most ranches were self-sufficient to some degree, and they had facilities for livestock other than cattle, for growing fodder, and to process some agricultural products. These facilities were important because they granted ranch families some independence and allowed them to realize income from surplus products. Livestock-specific facilities were located away from the residences and could have included a pig pen, chicken coop, and rabbit hutch. Facilities for crops were close to the fields and included a grain shed or silo and haystacks.

In many cases, the support facilities decayed due to neglect or were intentionally dismantled, leaving material evidence in various states of preservation. When reduced to manifestations buried or on ground-surface, the facilities can be categorized as archaeological features. Such remnants may be evaluated as contributing elements of a ranch complex or for individual eligibility. Following is a list of the most common livestock and crop outbuildings. Character-defining features, associated facilities, and related archaeological manifestations are at the subsection's end.

- Barn: A barn was a multipurpose building that housed fodder, tack, agricultural equipment and tools, and draft animals. Depending on location and era, settlers used logs, lumber, or a combination for walls and roofs. Large barns had at least lumber roofs, if not lumber walls. Most were drafty and had wide doorways and lofts.
- Chicken Coop: Chicken coops were usually small, made of lumber, divided into shelves, and had one open face.
- Grain Shed: Settlers erected grain sheds to store grain in bulk form. They were shed or gabled in form and of frame construction with plank siding on the interior face. Inside, the shed was divided for different grain types.

- **Rabbit Hutch:** Rabbit hutches were small sheds elevated on legs with an open face of chicken wire. The interior was divided into several cells for rabbits.
- **Stable:** Horses were a principal means of transportation around ranches, and they were housed in stables separately from common livestock. Stables were similar to but smaller than barns. Their interiors were divided into stalls with feed troughs, and lofts for the storage of fodder.
- **Tack Shed:** A small building in which settlers stored tack and hardware for managing animals. Tack houses were usually shed in form and of logs or lumber. The interior should feature nails and hooks for hanging tack and shelves for tools.

Ranch Significance

Ranches were associated with and participated in a variety of important trends. These are summarized as the Areas of Significance: Agriculture, Architecture, Commerce, Economics, Exploration/Settlement, Industry, and Politics/Government. Period of Significance must be considered when determining the historical importance of ranches. Although the period applicable to the I-70 corridor spans 1860 to 1960, the significance of ranching varies slightly by corridor segment. Ranching was important in Clear Creek County between 1870 and 1900 and in the rest of the corridor from 1875 until 1960. Level of significance was local.

Area of Significance: Agriculture: Ranching was an important agricultural institution in the central mountains for several reasons. The earliest ranchers adapted known livestock practices to the rigorous mountain climate. Through trial and error, they determined which breeds were the most suitable, how to ensure reliable sources of feed, and how to manage open rangeland. Ranches were also a vehicle for the adaptation of agricultural and livestock operations on the Rocky Mountain frontier. Cattlemen planned overall property improvements according to their perception of efficiency in several arenas. They considered the needs of residential occupation by the family and workforce within the context of the immediate environment. Ranchers arranged crop storage facilities to enhance cultivation processes and handle harvested products. They planned irrigation to deliver water from a source to fields and livestock. Most important, ranchers designed systems of barns, stables, and corrals to process livestock in commercial numbers. Cumulatively, their knowledge became a foundation for sustainable ranching, vital to the economy and permanent Euro-American presence.

Area of Significance: Architecture: Ranches were important in the Area of Architecture for several reasons. Ranchers adapted familiar building designs and methods of construction to the frontier conditions of the Rocky Mountains. Some of the conditions included topography, natural landscape features, local climate, and available building materials. In many cases, economic constraints influenced how ranchers adapted designs and construction methods. Ranchers were also influential in introducing formal building design and elements of architectural style to the central mountains. They did so primarily with residential buildings, contributing to the development of rural architecture in the central mountains. For a list of significant types, see the list at the subsection's end, as well as Section B 8.

Area of Significance: Commerce: Ranching began its commercial significance as an important link in the early frontier economy of the central mountains. Ranchers produced meat for miners and loggers, and fodder for their animals, selling these materials at local market. In so doing,

ranchers fostered the agricultural segment of mountain commerce and contributed to the growing complexity of regional economies.

By the 1880s, ranching became one of the most stable forms of commerce in the mountains. Mining and logging were the principal industries, but they underwent cycles of boom and bust because these industries were based on resource extraction. The effect was general instability. Ranching, by contrast, was mostly sustainable and depended on distant markets as much as local outlets, which translated into greater stability for their associated communities. The permanent ranching population and its economic contributions moderated the bust periods and helped some towns such as Dillon, Gypsum, and Eagle to weather the depressions affecting mining communities.

Area of Significance: Economics: Ranching was significant in the Area of Economics for the wealth it brought to associated communities. In producing and selling food to regional mining and logging towns, ranchers generated income. They disbursed some of the money among their associated communities in turn by purchasing goods and paying for services. Cumulatively, the ranches became important economic contributors, supporting local business and providing the communities with income.

Area of Significance: Exploration/Settlement: Ranches may be associated with several important aspects of exploration and settlement. Cattlemen were among the first permanent settlers in the Blue River drainage, arriving within a short time after miners and homesteaders. Ranchers pioneered several sections of the Eagle and Colorado rivers as well, settling in advance of other forms of industry. When defining their grazing ranges, early ranchers explored those areas missed by prospectors, contributing to a growing body of knowledge regarding regional geography and natural resources.

Ranching fostered the settlement of some communities in the corridor. Towns such as Dillon, Dotsero, Eagle, and Gypsum depended on the ranching economy as much as mining or railroads. Because ranching was sustainable, these towns remained stable and even grew during times when mining towns went bust.

Area of Significance: Industry: Independent ranchers, but especially company operations, brought one of the first organized industries into the corridor besides mining and logging. Ranching was one of the few sustainable industries, and although it suffered during periods of depression, ranching provided some economic stability. The industry produced food, provided employment, and supported the towns of Dillon, Dotsero, Eagle, Gypsum, and Minturn.

Area of Significance: Politics/Government: Ranches were physical manifestations of federal policies designed to encourage settlement of the West. The Homestead Act of 1862 provided title to 160 acres after five years occupation and payment of application fees. The Timber Culture Act of 1873 allowed settlers to buy 160 acres for \$1.25 per acre if they planted one-quarter with trees and maintained them for 10 years. The Desert Land Act of 1877 conveyed 640 acres for \$.25 per acre if the claimant proved irrigation within three years. Ranchers used all three acts to secure prime ranch land that remained in service for decades.

The livestock industry directly influenced the federal government's change in attitude toward public land from passive to active management. In response to overgrazing and other lapses in stewardship, the Department of Agriculture began issuing grazing permits on Forest

Reserve land in 1899, and the General Land Office followed with Department of the Interior land in 1901. The government passed the Newlands Act the following year and initiated large water diversion projects that benefitted ranching. Last, the cattle industry demanded better policy for setting aside public lands, and the government instituted the Taylor Grazing Act in 1934. All in turn shaped the livestock industry.

Ranch Registration Requirements

To qualify for the NRHP, ranches must meet at least one of the Criteria listed below and possess adequate physical integrity to convey their significance.

Criterion A: Ranches eligible under Criterion A must be associated with at least one Area of Significance noted above as well as a contribution to a broad pattern of history.

Criterion B: Ranches may be eligible under Criterion B provided an association with the life of an important person significant in our past. Presence will most likely be through residence, employment, or other involvement with the ranching operation. The associated resource must retain physical integrity relative to that person's productive life. A brief biography is necessary to detail the individual's significant contributions. In some cases, important people invested in livestock operations or owned a ranch, but did not occupy the property. Such an association does not meet the registration requirements outlined here. The individual of note must have been present on-site. *National Register Bulletin 32: Guidelines for Evaluating and Documenting Properties Associated with Significant Persons* can provide further guidance.

Criterion C: A ranch may be eligible under Criterion C if its buildings are good representative examples of significant architectural types or styles. Similarly, a ranch may be eligible if its structures and objects are good representative examples of significant types or designs. The overall assemblage of buildings, structures, and archaeological features may also be a sound example of design, agricultural practices, and land use specific to ranches. Discernible patterns of cultivation, irrigation, or animal husbandry may be expressed as a rural historic landscape. In such cases, the homestead may qualify as the historic landscape property type discussed below.

Criterion D: Buildings, structures, and land use modifications often left archaeological evidence when removed or abandoned. When this evidence clearly represents the ranch during the Period of Significance, the site retains integrity on an archaeological level. For archaeological remains to constitute integrity, the material evidence should permit the virtual reconstruction of the ranch complex and aspects of the livestock operation. If archaeological features and artifacts offer important information regarding ranch design and operation, then the site may qualify under Criterion D. The site may also qualify if the material remains reflect settlement patterns, or aspects of the demography and lifestyles of the ranch family, operator, or workforce.

If the ranch possesses building platforms, privy pits, and refuse dumps, testing and excavation of these buried archaeological deposits may reveal important information regarding lifestyle and demography within the livestock industry. Areas of inquiry may include but are not limited to diet, health, gender and family, ethnicity and cultural practices, socioeconomic status, agricultural practices, and animal husbandry.

Ranches must possess physical integrity relative to the Period of Significance outlined in Section A. Few ranches will appear as they did when initially established. Many were occupied for extended periods and modified over time. Such ranches represent the evolution and, most likely, changes in the livestock operation. Ranchers abandoned obsolete or worn structures and buildings in favor of new ones and moved some buildings and structures to fulfill needs. Thus, some buildings and structures may not be in their exact location of construction, and others may be in advanced states of decay.

Many of the NRHP aspects of historic integrity apply to ranches, although not all need be present. Integrity must be sufficient to convey the Property Type and its significance. To retain integrity of *location*, a structure or building should be on the ranch in a location of functional use. For a resource to retain integrity of *design*, the ranch's material remains must convey the organization and planning of the residential complex, support facilities, and cultivation. To retain *setting*, the ranch complex and the surrounding agricultural land must not have changed a great degree from its occupation. In terms of *feeling*, the resource should convey ranching from a historical perspective and in the context of land use today. Integrity of *association* exists where structures, buildings, and archaeological features convey a strong connection between ranching and a contemporary observer's ability to discern the historic activity.

PROPERTY TYPE: FARM

A farm was an agricultural business specializing in growing grain and produce on a commercial scale. Many farms began as homesteads, but when they crossed the threshold into commercial agriculture, they became farms by definition. Isolation required operations to be self-sufficient to some degree, and they kept livestock and grew fodder. Such farms featured some attributes characteristic of the ranch property type defined above. Most farms in the I-70 corridor produced cold weather vegetables, tree fruit, and grain.

The size and content of a farm was a function of its business model, era, and location. Early and remote farms, usually run by families, tended to be small and consisted of essential buildings and structures. Companies invested capital in advanced irrigation systems, mechanization, and workers' housing. Many farms that started small grew over time, and their complexes tended to include a variety of buildings and structures different in age.

Farms followed traditional agricultural land use patterns, consisting of a cluster of residential buildings, support structures and outbuildings, and expansive tracts of cultivated land. Most were concentrically arranged around a water supply, preferably a spring because of purity. The residential buildings formed a core, and the support facilities were scattered around the outside. This complex was center to irrigated fields of crops that required intensive cultivation, and they were in turn surrounded by dry fields planted with fodder or grain.

Small farms usually had substantial houses for the family and cabins for several hands, and agricultural companies added bunkhouses and cookhouses for seasonal workforces. Nearly all farms had other facilities that supported daily life such as a well or spring, root cellar, smokehouse, outhouses, and an area where the residents disposed of solid waste.

Farm complexes included facilities supporting the business of growing and harvesting crops. Most of these improvements were near the residence, although some were adjacent to produce fields. Farmers relied on draft animals for motive power and other livestock as food. Cattle produced milk, chickens laid eggs, and these animals, as well as pigs, were also butchered

for meat. Barns, stables, corrals, coops, and poultry houses typically sheltered the livestock. Farmers kept produce in storehouses, root vegetables in potato cellars, eggs and dairy in cold cellars, and grain in silos and grain sheds. In the arid mountains, irrigation was necessary for agriculture on a commercial scale, and most farms had water systems of varying sophistication. At a minimum, feed ditches collected water from a source, often a stream or water company canal, and distribution ditches then carried portions of the flow to high points on the field. By the 1910s, pumps extracted water from wells and piped it into ditches, and during the 1950s, rotary spray systems distributed water over fields. In general, crop storage buildings and structures and substantial irrigation systems are distinguishing characteristics of farms. Other outbuildings typically included a blacksmith shop, tack shed, equipment barns, and milking sheds.

Era and location influenced the materials, construction, and sizes of individual buildings and structures. Early buildings were simple, small, and made of local materials. Logs were universal throughout the I-70 corridor, and farmers made extensive use of native stone for storage buildings. Lumber became widely available by the 1870s in the Clear Creek and Blue River drainages and by the 1880s on the Eagle and Colorado rivers. Farmers then transitioned into frame construction for principal buildings, although many continued to use logs into the 1910s. Corrugated sheet iron became popular for roofs by around 1900.

At present, few farms appear exactly as they did when founded. Many have been continually occupied, evolving over time to suit changing needs and land use patterns. Although core buildings such as the residence and barn may date to the original time of settlement, property owners added and removed facilities and outbuildings. Thus, buildings and structures may feature a variety of construction materials, methods, and workmanship.

Some complexes have suffered demolition by neglect, or their structures and buildings removed altogether, nevertheless leaving distinct archaeological evidence. When the evidence clearly represents the farm and its history, the assemblage may qualify for the NRHP as an archaeological expression of a farm.

Farm Property Subtypes

Property Subtype: Farm Residential Building: The primary residential building at a farm was the farmhouse, where the family slept, cooked, dined, attended to domestic duties, conducted their agricultural business, and otherwise interacted as a family. The kitchen was a center of life, and it was usually large and well-appointed. Some houses at company operations had quarters for visitors and a dining room for hired hands. Most farms also had cabins for extended family and hands. The cabins were small and had several bedrooms and a common room. Families occupied cabins as self-contained households, and in such cases, the cabins featured kitchens. Farm hands typically shared quarters and dined together on meals provided by the farmer. Companies with large operations employed workforces that were too numerous for simple cabins. Instead, the hands lived in bunkhouses that featured bedrooms and a common area. The occupancy of cabins and bunkhouses by farm hands tended to be somewhat seasonal, corresponding with planting and harvest.

Farmhouses went through a similar evolution as ranch and homestead houses. Many early farmhouses were transitional dwellings built by a homesteader. These were typically small, single-story, rectangular-shaped dwellings of log or wood frame construction (as described above under the Homestead property subtypes). As farms became economically viable enterprises, transitional dwellings were replaced with more substantial 1½-story, Gabled-L, and

Gabled-T shaped dwellings and eventually, by recognizable dwelling types such as the I-House, Hipped-Roof Box, Foursquare, Classic Cottage, and Bungalow (see below).

Early farmhouses were vernacular, with form and construction influenced by a number of factors. They were rarely architect-designed or built by professional contractors, and instead were influenced by the perceived needs and abilities of their owners. Construction was affected by climate, topography, soil conditions, availability of building materials, and other physical characteristics specific to the region. Farmhouses were also a product of economic factors and of time by the dissemination of popular building materials, techniques, styles and details. Early farmhouses were traditional because they reflected the construction techniques, traditions, and cultural influences passed down through generations and adapted to the Colorado frontier.

Because most farms postdated railroads and the rise of the lumber industry, houses were predominantly built of frame construction and occasionally of brick or stone masonry. In time, they also displayed stylistic influences and ornamental details, expressing a farmer's individual tastes and traditions, and increasingly, architectural fashions then in vogue. Although such farmhouses were vernacular, they were not constructed with local materials, but rather with manufactured lumber and other building supplies, delivered by the railroad and purchased from local retail suppliers.

Although farmhouses continued to reflect their owners' traditions, they also were increasingly influenced by the spread of architectural styles and ornamental details, made popular by the diffusion of architectural pattern books and magazines. House plans and ornamental details became available through Sears, Roebuck & Company and popular magazines such as *House Beautiful* and *Ladies Home Journal*. Around the same time, architectural publications such as the *Craftsman*, *Western Architect* and *Architectural Record* began to promote and distribute plans for specific types of houses, notably the Craftsman Bungalow. The influence of such publications, and the availability of manufactured materials, initially manifested as ornamental details such as porch rails, columns, brackets, and other decorative elements, often applied to vernacular residences. New houses tended to reflect the latest architectural trends and styles, although vernacular and traditional influences were common well into the twentieth century. Below is a list of the predominant types of farmhouses. Character-defining features are summarized at the subsection's end, as well as Section B 8.

- Single-Pen Cabin: Rectangular, front-gabled roof, one room.
- Double-Pen Cabin: Rectangular, front-gabled roof, two rooms.
- Shotgun Cabin: Rectangular, front-gabled roof, one-room wide, two or more rooms deep.
- Hall-and Parlor: Rectangular, front-gabled roof, two rooms with one larger than the other.
- Gabled-L: L-Shaped, with a cross-gabled roof, a parlor in the side-gabled wing, a bedroom in the front-gabled wing, and kitchen at rear.
- Gabled-T: T-Shaped, cross-gabled roof, usually with a side-gabled front wing and a centered rear gable. An enclosed shed-roofed rear porch often fills one of the voids formed by the T-shaped plan.
- I-House: Enlarged version of Hall-and-Parlor plan. The design is two-rooms wide, one-room deep, with a central passage or hallway separating the rooms.
- Hipped-Roof Box: a simple rectangular (nearly square) plan covered by a hipped roof. The type is usually slightly shorter across the façade than the length. The core plan was often modified by an enclosed, shed-roofed rear mud porch.
- Pyramid Cottage: a small, usually square version of the Hipped-Roof Box house.
- Foursquare House: a 2½-story version of the Hipped-Roof Box.
- Classic Cottage: a stylized, 1½-story version of the Foursquare house. Classic Cottage houses are usually of brick or stone masonry, and frame examples are rare.

- **Bungalow:** this type features low, horizontal lines; low-pitched, gabled or hipped roofs; often with knee braces in the upper gable ends. Facades are dominated by a broad stairway leading to a full or nearly full-width front porch. Porch roofs are supported by battered pedestals, topped by large, square-post piers, creating a heavy, horizontal emphasis.

Property Subtype: Farm Support Facilities: Houses and cabins served many basic needs of farm life, but they were unable to fulfill all functions. Other facilities around the residences provided water, heating fuel, food storage, and waste disposal. The support facilities were important because they provided for necessities in addition to shelter and food preparation.

In many cases, support facilities decayed due to neglect or were intentionally dismantled, leaving material evidence in various states of preservation. When reduced to manifestations buried or on ground-surface, the facilities can be categorized as archaeological features. Such remnants may be evaluated as contributing elements of the farm complex or for individual eligibility. Following is a list of the most common support outbuildings. Greater detail, associated facilities, and archaeological manifestations are described at the subsection's end.

- **Blacksmith Shop:** A building where a settler fabricated and maintained tools and hardware. Simple shops usually featured a blacksmith forge, workbench, and possibly hand-powered appliances such as a drill press or lathe.
- **Cookhouse:** Companies erected cookhouses at large farms and ranches to feed workforces en masse. A cookhouse was a building, usually vernacular in form, with a large kitchen and dining area.
- **Icehouse:** Ranchers used icehouses both to store ice for warm months and as primitive refrigerators. Icehouses usually were countersunk into the ground and consisted of stone masonry for insulation, and they featured storage shelves.
- **Privy:** A building that served as a toilet facility. Privies stood over pits, were around 4'x5' in area, and featured a bench with a cut-out as a toilet seat.
- **Root Cellar:** Root cellars were independent structures used for food storage. They often manifest as small dugouts with earthen roofs and façades of rocks, logs, or lumber.
- **Smokehouse:** Ranch families preserved meat by jerking and smoking in small, insulated buildings. Windows were few, and the buildings had drying racks, chimneys, or stovepipes.
- **Spring House:** When possible, settlers relied on springs for drinking water because of their purity. The settler erected a small masonry or frame enclosure over the spring to keep out debris, and provided an outlet for overflow water. The enclosure usually had a gabled or shed roof.
- **Storehouse:** Storehouses were small buildings of lumber or logs for the storage of goods other than food.
- **Woodshed:** Because wood was a primary heating and cooking fuel, a supply kept dry in a shed was critical. Sheds were small, of log or frame construction, and may have been open.

Property Subtype: Farm Livestock and Crop Storage Facilities: Commercial farming required facilities specific to the industry. The most iconic were barns and crop storage buildings and structures, and these are characteristic of the property subtype. Farms also had facilities for livestock and processing some agricultural products such as dairy. These facilities were important because they allowed farming operations some diversity of income and economic independence. Livestock-specific facilities were located away from the residences and included a corral, pig pen, chicken coop, and rabbit hutch. Facilities for crops were close to the fields and included a grain shed or silo, potato cellars, and haystacks.

In many cases, the support facilities decayed due to neglect or were intentionally dismantled, leaving material evidence in various states of preservation. When reduced to manifestations buried or on ground-surface, the facilities can be categorized as archaeological features. Such remnants may be evaluated as contributing elements of the farm complex or for individual eligibility. Below is a list of the most common livestock and crop outbuildings. Their

character-defining features, related facilities, and archaeological manifestations are described at the subsection's end.

- **Barn:** A barn was a multipurpose building that housed fodder, tack, agricultural equipment and tools, and draft animals. Depending on location and era, settlers used logs, lumber, or a combination for walls and roofs. Large barns had at least lumber roofs, if not lumber walls. Most were drafty and had wide doorways and lofts.
- **Chicken Coop:** Chicken coops were usually small, made of lumber, divided into shelves, and had one open face.
- **Grain Shed:** Settlers erected grain sheds to store grain in bulk form. They were shed or gabled in form and of frame construction with plank siding on the interior face. Inside, the shed was divided for different grain types.
- **Milking Barn:** Dairy products were an important source of income for many farms, and cows were milked in buildings known as dairy barns, milking barns, and milk houses. Most milking barns were of frame construction and sided with planks or, by the 1950s, corrugated sheet iron. The interiors were designed to be washed and featured stalls lined with sheet iron, as well as concrete floors with drainage systems.
- **Potato Cellar:** Potato cellars, similar to bunkers, were countersunk into the ground, lagged on the interior with planks, and covered with earth. The cellars were at least 8'x10' in area with broad doorways.
- **Poultry House:** Some farmers raised chickens and turkeys in commercial numbers and kept the fowl in elongated frame buildings. The interior featured two or more rows of cubicles for the birds usually on concrete floors. The structures were shed or gabled in form and based on lumber frames sided with planks or, by the 1950s, corrugated sheet iron.
- **Rabbit Hutch:** Rabbit hutches were small sheds elevated on legs with an open face of chicken wire. The interior was divided into several cells for rabbits.
- **Stable:** Horses were a principal means of transportation around ranches, and they were housed in stables separately from common livestock. Stables were similar to but smaller than barns. Their interiors were divided into stalls with feed troughs, and lofts for the storage of fodder.
- **Tack Shed:** A small building in which settlers stored tack and hardware for managing animals. Tack houses were usually shed in form and of logs or lumber. The interior should feature nails and hooks for hanging tack and shelves for tools.

Farm Significance

As historic resources, farms were associated with and participated in a variety of important trends. These are summarized as the Areas of Significance: Agriculture, Architecture, Commerce, Economics, Industry, and Politics/Government. Significance is local, but could be statewide depending on further research.

Period of Significance must be considered when determining the historical importance of farming. Although the Period applicable to the I-70 corridor spans 1860 to 1960, farming was an important movement for a smaller portion of this timeframe. Further, the significance of farming varies slightly by corridor segment. Commercial farming was unimportant in Clear Creek County because the region was not conducive to agriculture, and the railroad hauled in agricultural products from elsewhere. Farming was important along the Eagle and Colorado rivers from 1885 until 1960 and along the Blue River from around 1900 until 1920.

Area of Significance: Agriculture: Farming was a significant agricultural institution in the central mountains for several reasons. The earliest farmers adapted known agricultural practices to the rigorous mountain climate. Through trial and error, they determined which crops were the most suitable, what the growing seasons were, and appropriate cultivation methods. The growers planned overall property improvements according to their perception of efficiency in several

arenas. They considered the needs of residential occupation for the family and workforce within the context of the immediate environment. Farmers arranged support facilities to enhance cultivation processes, and crop storage facilities for harvested products. Equally important, farmers also directly fostered the local development of irrigation systems, which were a requisite for successful agriculture. Farmers built some of the systems, and subscribed to water companies that built others. The systems were lasting and allow agriculture to continue today. Cumulatively, their knowledge became a foundation for sustainable farming, which was vital to the economy and for providing food to Colorado.

Area of Significance: Architecture: Farms were important in the Area of architecture for several reasons. Farmers adapted building designs and methods of construction already established for agriculture to the frontier conditions of the Rocky Mountains. Some of the conditions included topography, natural landscape features, local climate, and available buildings materials. In many cases, economic constraints influenced how farmers adapted designs and materials. Farmers participated in the introduction of formal building design and elements of architectural style to the Eagle and Colorado River valleys. They did so primarily with residential buildings, and although most were vernacular, some farmers relied on formal designs and incorporated elements of architectural style. For a list of significant types, see the subsection's end, as well as Section B 8.

Area of Significance: Commerce: Farming was commercially significance as an important component in economy of the central mountains. In selling produce and fodder to regional mining and logging towns, farmers contributed heavily to the agricultural segment of mountain commerce.

By 1900, farming became one of the most stable forms of commerce in the mountains. Mining and logging were the principal industries, but they underwent cycles of boom and bust because these industries were based on resource extraction. The effect was general instability. Farming, by contrast, was sustainable and depended on distant markets as much as local outlets, which translated into greater stability for their associated communities. The permanent agricultural population and its economic contributions moderated the bust periods and helped some towns such as Gypsum and Eagle weather the depressions affecting mining communities.

Area of Significance: Economics: Farming was significant in the Area of Economics for the wealth it brought to associated communities. In producing and selling food to regional mining and logging towns, farmers generated income. They disbursed some of the money among their associated communities in turn by purchasing goods and paying for services. Cumulatively, the farmers became important economic contributors, supporting local business and providing the communities with income.

Area of Significance: Industry: Independent farmers, but especially company operations, brought one of the most important organized industries into the corridor besides mining and logging. Farming was also one of the few sustainable industries, and although it suffered during periods of depression, farming provided some economic stability. Overall, the industry produced food, provided employment, and supported the towns of Dillon, Dotsero, Eagle, and Gypsum.

Area of Significance: Politics/Government: The agricultural industry directly influenced politics and government in several ways. First, the industry was largely reliant on irrigation, based on water captured from streams and rivers. In some cases, farmers controlled their own supply, but most farmers subscribed to cooperatives and companies. Such organizations secured water rights to ensure reliable supplies. In so doing, and by defending their rights against other claimants, the organizations contributed to the complex field of water law and associated government administrations. Second, farming influenced the federal government's change in policy regarding publicly held natural resources from passive to active management. In 1902, the government passed the Newlands Act to foster the growth of the agricultural industry. The act charged the Bureau of Reclamation with creating large-scale water diversion and distribution systems, supporting agriculture in otherwise arid lands.

Farm Registration Requirements

To qualify for the NRHP, a farm must meet at least one of the Criteria listed below, and possess adequate physical integrity to represent the Property Type and convey its significance.

Criterion A: Resources eligible under Criterion A must be associated with at least one Area of Significance noted above as well as a contribution to a broad pattern of history.

Criterion B: Farms may be eligible under Criterion B provided an association with the life of an important person significant in our past. Presence will most likely be through residence, employment, or other involvement with the farming operation. The associated resource must retain physical integrity relative to that person's productive life. A brief biography is necessary to detail the individual's significant contributions. In some cases, important people invested in or owned farms but did not occupy the property. Such an association does not meet the registration requirements outlined here. The individual of note must have been present on-site. In general, applying Criterion B is complex, and *National Register Bulletin 32: Guidelines for Evaluating and Documenting Properties Associated with Significant Persons* can provide further guidance.

Criterion C: Farms may be eligible under Criterion C if the buildings are good representative examples of significant architectural types or styles. Similarly, a farm may be eligible if the structures and objects are good representative examples of significant types or designs. The overall assemblage of buildings, structures, and archaeological features may also be a sound example of design, agricultural practices, and land use specific to farms. Discernible patterns of cultivation, irrigation, or animal husbandry may be expressed as a rural historic landscape. In such cases, the homestead may qualify as the historic landscape property type discussed below. See the subsection's end, and Section B 8, for significant resource types.

Criterion D: Buildings, structures, and land use modifications often left archaeological evidence when removed or abandoned. When this evidence clearly represents the farm during the Period of Significance, the site retains integrity on an archaeological level. For archaeological remains to constitute integrity, the material evidence should permit the virtual reconstruction of the farm complex and aspects of the agricultural operation. If archaeological features and artifacts offer important information regarding farm design and operation, the site may qualify under Criterion D. The site may also qualify if the material remains reflect settlement patterns, or aspects of the

demography and lifestyles of the farm family, operator, or workforce. Common architectural, structural, and archaeological features are noted under the feature types below.

If the farm possesses building platforms, privy pits, and refuse dumps, testing and excavation of these buried archaeological deposits may reveal important information regarding lifestyle and demography within the farming industry. Areas of inquiry may include but are not limited to diet, health, gender and family, ethnicity and cultural practices, socioeconomic status, agricultural practices, and animal husbandry.

Farms must possess physical integrity relative to the Period of Significance outlined in Section A. Few farms will appear as they did when initially established, as many were occupied for extended periods and modified over time. Such farms represent the evolution and, most likely, mechanization of an agricultural operation. Farmers abandoned obsolete or worn structures and buildings in favor of new ones, moving some buildings and structures to fulfill new needs. Thus, some buildings and structures may not be in their exact location of construction, and others may be in advanced states of decay.

Many of the seven aspects of historic integrity defined by the NRHP may apply to farms, although not all need be present. Integrity must be sufficient to represent the Property Type and convey its significance. To retain integrity of *location*, a structure or building should be on the farm in a location of functional use. For a resource to retain integrity of *design*, the farm's material remains must convey the organization and planning of the residential complex, the support facilities, agricultural facilities, and cultivation. To retain integrity of *setting*, the farm complex and the surrounding agricultural land must not have changed a great degree from its period of occupation. In terms of *feeling*, the resource should convey a perception of farming from a historical perspective and in the context of regional land use today. Integrity of *association* exists where structures, buildings, and archaeological features convey a strong connection between farming and a contemporary observer's ability to discern the historic activity.

PROPERTY TYPE: RURAL HISTORIC AGRICULTURAL LANDSCAPE

Rural Historic Landscapes are large-scale cultural resources that, in a broad sense, represent the history of an area's human occupation, life ways, and the relationship with the land. For the National Register, the National Park Service recognizes other types of landscapes such as designed historic landscapes. Rural historic landscapes possess characteristics that distinguish them from the other categories. Designed historic landscapes, for example, were consciously planned according to specific principals, often of landscape architecture. Rural historic landscapes, in contrast, evolved organically over time. The National Park Service explains Rural Historic Landscapes in detail in its *National Register Bulletin: Guidelines for Evaluating and Documenting Rural Historic Landscapes*. In overview, the Bulletin states:

A rural historic landscape is defined as a geographical area that historically has been used by people, or shaped or modified by human activity, occupancy, or intervention, and that possesses a

significant concentration, linkage, or continuity of areas of land use, vegetation, buildings and structures, roads and waterways, and natural features.⁶⁹⁰

Within the theme of agriculture, rural historic landscapes form a physical context for homestead, ranch, and farm resources in the I-70 corridor. The individual resources are components of a greater whole in terms of geography, history, and community, even when disbursed. In general, the extensive tracts of land combined with natural features and smaller scale historic resources represent the history, people, and traditions of homesteading, ranching, and farming.

Historic landscapes possess defining characteristics, and the National Park Service organized them into 11 categories. The first four are a result of processes, and the last seven are physical attributes.⁶⁹¹ The categories are relevant to agricultural landscapes in the I-70 corridor, and include the following: land uses and activities; patterns of spatial organization; response to the natural environment; cultural traditions; circulation networks; boundary demarcations; vegetation related to land use; buildings, structures, and objects; clusters; archaeological sites; and small-scale elements.

The defining characteristics of a rural historic landscape also can be described in terms of “landscape of work.”⁶⁹² When settlers converted large tracts of the natural environment for their agricultural operations, they molded the landscape for efficiency, organization, sustainability, and suitability of crops and grazing. Landscapes of work for agriculture feature defining characteristics and patterns. A common pattern included a central residence, nearby outbuildings and structures for occupant needs, and more outbuildings and facilities in support of agriculture. Further, the residential outbuildings and facilities were often clustered for efficiency of domestic work and likewise for the agricultural facilities. Fields and pasture were also organized for efficiency of work. Crops requiring intensive cultivation were nearest the residential complex for ease of accessibility, and grazing pasture and fields for less intensive crops were farther away. Circulation systems in the form of roads and paths linked the fields and associated nodes of activity, such as grain sheds and corrals, with the farm or ranch complex. Irrigation systems connected water-intensive crops with sources such as streams and community ditches. Although topography, stream channels, and available flat ground dictated the shape of some fields, farmers and ranchers preferred the geometry of straight boundaries. Fences, irrigation systems, circulation systems, and tracts of natural landscape also conformed to the linear preference.

In many cases, landscapes of work are still in use for agriculture and support the continuation of rural cultural traditions. Homesteaders, ranchers, and farmers had tangible impacts on I-70 corridor by converting natural areas into fields, changing stream patterns and redistributing water, and erecting their residential complexes in locations with specific conditions. Agricultural facilities and aspects of the natural environment may be interspersed, and both should be considered together as a whole. Because landscapes were used continually over time, most will probably encompass combinations of resources specific to the property types of homesteads, ranches, and farms.

⁶⁹⁰ McClelland, Linda Flint, Keller, J. Timothy, Keller, Genevieve P., and Melnick, Robert Z. *National Register Bulletin: Guidelines for Evaluating and Documenting Rural Historic Landscapes*. National Park Service, 1999 [1989], 1.

⁶⁹¹ McClelland, et al., 1999:3.

⁶⁹² Messick, Denise P., Joseph, J.W., and Adams, Natalie P. *Tilling the Earth: Georgia's Historic Agricultural Heritage, A Context*. Stone Mountain, GA: New South Associates, 2001, 62.

Rural Historic Agricultural Landscape Significance

Because multiple historic resources and natural features make up rural historic landscapes, significance can be assessed in terms of the broad, historical theme of agricultural settlement and industry. Further, significance can be assessed within the narrower subsets of homesteading, ranching, and farming. The most relevant NRHP Areas of Significance include Agriculture, Architecture, Community Planning and Development, Industry, and Landscape Architecture. Because of complexity, diversity of constituent historic resources, most landscapes will be significant under multiple NRHP Areas and criteria.

Period of Significance must be considered when determining the historical importance of rural historic landscapes. Although the Period applicable to the I-70 corridor spans 1860 to 1960, the effective timeframe for agriculture varies slightly by corridor segment and land use. See the introduction of agriculture in Section A for the timeframes.

Area of Significance: Agriculture: Historic landscapes can represent the widespread adaptation of agricultural practices to the central Rocky Mountains. Homesteaders, ranchers, and farmers experimented with cultivation and grazing, determining which practices were suited for the climate and environment. Over time, they were successful, creating a foundation for an agricultural industry on a scale large enough to support a regional economy and contribute food to a large market.

Farmers and ranchers also contributed to the development of irrigation systems, a requisite for successful agriculture. These were part of and influenced the development of landscapes. In particular, the systems allowed agriculture to spread across expansive tracts of land, with some still serving this function today.

Area of Significance: Architecture: Those historic landscapes with standing buildings are important in the Area of Architecture for several reasons. Homesteaders, ranchers, and farmers adapted building designs and methods of construction already established for agriculture to the frontier conditions of the Rocky Mountains. Some of the conditions included topography, natural landscape features, local climate, and available buildings materials. Settlers also participated in the introduction of formal building design and elements of architectural styles. In the context of a landscape, a spectrum of buildings can represent the evolution of rural architectural development.

Areas of Significance: Community Planning and Development: Rural landscapes can be important in the Area of Community Planning and Development if they reveal settlement and land use patterns. Landscapes can reflect the patterns for the development of individual agricultural enterprises, the development of agriculture as a regional industry, and its influence on entire communities.

Area of Significance: Industry: Homesteaders, ranchers, and farmers, and their companies, brought one of the most important recognized industries into the corridor besides mining and logging. Agriculture was one of the few sustainable industries, and although it suffered during periods of depression, agriculture provided some economic stability. The industry produced food, provided employment, and supported the towns of Dillon, Dotsero, Eagle, Gypsum, and Wolcott.

Area of Significance: Landscape Architecture: By nature, agriculture involved the modification of extensive land tracts. Homesteaders and farmers purposefully converted natural areas into fields, and ranchers changed vegetation patterns by grazing their cattle and sheep. The above participants also impacted stream patterns, redistributed water, and erected their residential complexes in locations with specific conditions. On a large scale, agriculture changed the appearance of landscapes and their ecosystems.

Rural Historic Agricultural Landscape Registration Requirements

To qualify for the NRHP, a landscape must meet at least one of the Criteria listed below, and possess sufficient physical integrity to convey significance.

Criterion A: To be eligible under Criterion A, landscapes relevant to the theme of agriculture must be associated with events and broad trends of importance. Examples of broad trends include, but are not limited to, the Areas of Significance noted above.

Criterion B: Large-scale landscapes may be eligible under Criterion B provided that they were directly associated with the life of an important person significant in our past. At small-scale landscapes such as individual homesteads, ranches, and farms, association may be through residence, employment, or other involvement by a significant individual. The associated resource must retain physical integrity relative to that person's productive life. The researcher must detail the individual's significant contributions in a brief biography. In some cases, important people invested in agricultural enterprises or owned land but did not occupy the property. Such an association does not meet the registration requirements for Criterion B. The individual of note must have been present on the site. In general, applying Criterion B is complex, and *National Register Bulletin 32: Guidelines for Evaluating and Documenting Properties Associated with Significant Persons* can provide further guidance.

Criterion C: Historic landscapes may be eligible under Criterion C if buildings, structures, and landscape features represent agricultural land use and community development patterns. Because landscapes were occupied for extended periods of time, the patterns can be expected to reflect the evolution of general land use through the Period of Significance. Intact buildings may be significant representations of agricultural architecture in the central mountains. Multiple buildings within a single landscape may represent the evolution of type, style, methods, workmanship, and materials. Similarly, structures may be significant representations of agricultural practices, and multiple structures within a single landscape may represent the evolution of function, design, methods, workmanship, and materials. Buildings and structures may also exemplify characteristics distinct to the corridor. Natural features often are contributing elements.

Criterion D: Buildings, structures, and land modifications often left archaeological evidence when removed or abandoned. When this evidence clearly represents land use patterns, then the landscape retains integrity on an archaeological level. For archaeological remains to constitute integrity, the material evidence should represent the general layout of individual homesteads, ranches, and farms, as well as their relationships to the community. If archaeological features

and artifacts are likely to yield important information regarding land use, community development, or agricultural practices, then the landscape may qualify under Criterion D.

If complexes within the landscape possess building platforms, privy pits, and refuse dumps, testing and excavation of these buried archaeological deposits may reveal important information regarding lifestyle and demography of the occupants. When the results from multiple complexes are compared, regional patterns may become apparent. Important areas of inquiry may include but are not limited to diet, health, distribution of gender, families, ethnicities, professional occupation, and socioeconomic status.

Historic landscapes eligible for the NRHP must possess physical integrity relative to the region's Period of Significance. According to the National Park Service: "Integrity requires that the various characteristics that shaped the land during the historic Period be present today in much the same way they were historically."⁶⁹³ All the landscapes in the I-70 corridor changed in varying degrees due to continuity in occupation and use. Continuations of agricultural traditions and use can be compatible with integrity by maintaining the character and feeling of agriculture. Modern intrusions can compromise integrity if out of keeping with agricultural land use patterns. Such intrusions should be few and unobtrusive.

The presence of some characteristics is more important to integrity than others. In terms of agriculture, land use patterns, vegetation, circulation systems, and the types of small-scale features typical of farms and ranches should be present.

Many of the seven aspects of historic integrity defined by the NRHP may apply to rural historic landscapes, although not all need be present. Integrity must be sufficient to convey the landscape's significance. *Location* is the place where the significant activities that shaped land took place. A rural landscape whose characteristics retain their historic location has integrity of location. For integrity of *design*, the landscape features, both manmade and natural, must convey organization and planning relative to agricultural land use. *Setting* is the physical environment within and surrounding a historic property. Both large-scale and small-scale features form a setting that conveys agricultural land use, settlement patterns, and cultural traditions. To retain integrity of setting, a landscape and bordering area must not have changed a great degree in overall character. For integrity of *feeling*, the landscape should convey agriculture and associated settlement from a historical perspective, and in the context of today's perceptions. Integrity of *association* exists where a combination of natural and manmade features conveys a strong connectedness between the landscape and a contemporary observer's ability to discern the historic agricultural industry and settlement.

⁶⁹³ McClelland, et al., 1999:21.

HIGH-ALTITUDE AGRICULTURE SITE FEATURES

Homestead, Ranch, and Farm Residence Types

Homestead Dugout – Typical Character-Defining Features

- One-story rectangular plan, at least 12' wide, 15' long, and 6' high.
- Built into slope.
- Horizontal round or hand-hewn log walls, with chinking, assembled with square-notched, V-notched, or saddle-notched front corners.
- Earthen floor, with sill logs resting directly on grade or crude stone foundation.
- Front-gable roof, with ridge-beam, log rafters, decking of split logs, mill-slabs, or planks, covered with earth.
- Stone chimney or stovepipe.
- Roof gable often overhangs the entry.
- Door and window frame members are 1" or 2" thick by 4" to 8" wide.

Single-Pen Log Cabin – Typical Character-Defining Features

- Core Plan: Rectangular, one room.
- Stories: 1 or 1½
- Foundation: Log or timber footers on earthen platform, crude stone foundation, or stone piers at the corners. Later foundations were concrete or concrete pargeting over stone.
- Walls: Horizontal logs, round or hewn, with chinking, assembled with square, V, saddle, or dovetailed joints. Corners may also display "hog trough" construction, with flush-sawn log ends nailed to end-plates.
- Roof: Front-gabled, with log beams or rafters, plank decking, and sheet metal or shingle cladding. Corrugated sheet iron, rolled asphalt, or asphalt shingles were common by around 1900.
- Chimney: Stone chimney or stovepipe, typically near the rear of the roof.
- Entry Door: Usually located in the gable end (front), with roof extension sheltering the entry. Early doors were made on-site of vertical planks and later were manufactured panel doors. Wooden door frames split from hand hewn logs or made of 1" or 2" thick milled lumber.
- Windows: Square or rectangular with frames split from hand hewn logs or made of 1" or 2" thick milled lumber.
- Porch: Small wood plank porch floor at the entry door, covered by the extended overhang of the roof eave or by a gable or shed porch roof with knee brace supports.

Double-Pen Log Cabin – Typical Character-Defining Features

- Core Plan: Rectangular, two rooms.
- Stories: 1 or 1½
- Foundation: Log or timber footers on earthen platform, rudimentary stone foundation, or stone piers at the corners. Later foundations were of concrete or concrete pargeting over stone.
- Walls: Same construction as Single-Pen above.
- Roof: Same construction as Single-Pen above.
- Entry Door: Same construction as Single-Pen above.
- Windows: Same construction as Single-Pen above.
- Porch: Small wood plank porch floor at the entry, covered by a roof overhang or by a gable or shed porch roof with knee brace supports.

Shotgun Log Cabin – Typical Character-Defining Features

A Shotgun Cabin is one-room wide, two or more rooms deep, with entry in the gable end (regarding front-gabled plan). There are no interior hallways, and the rooms are divided by transverse interior walls with doorways. The front room was usually the parlor, with the kitchen to the rear. Both log and wood frame examples may exist.

Hall-and-Parlor Log Cabin – Typical Character-Defining Features

- Core Plan: Rectangular, two rooms, with one room larger than the other. The larger room typically served as the kitchen and living space, while the smaller room served as a bedroom.
- Stories: 1 or 1½
- Foundation: Log or timber footers on earthen platform, rudimentary stone foundation, or stone piers at the corners. Later foundations were of concrete or concrete pargeting over stone.
- Walls: Same construction as Single-Pen above.
- Roof: Same construction as Single-Pen above.
- Chimney: Stone chimney or stovepipe, typically near the rear end of the roof.
- Entry Door: Located on the side elevation, beneath the roof eave (regarding side-gable plan), offset from center and entering the larger of the two rooms.
- Windows: Same construction as Single-Pen above.
- Porch: Small, wood plank porch floor at the entry door, covered by the roof eave or by a gable or shed porch roof with knee brace supports.

Gabled-L Log Cabin – Typical Character-Defining Features

- Core Plan: L-Shaped, with a cross-gabled roof, a parlor in the side-gabled wing, a bedroom in the front-gabled wing, and kitchen at rear.
- Stories: 1½, often with room for sleeping quarters in the upper half story.
- Foundation: Low, uncoursed stone foundation. Beginning circa 1900, foundations were made of poured concrete or stone with concrete pargeting.
- Walls: Same construction as Single-Pen above.
- Roof: Same construction as Single-Pen above. Some 1½-story Gabled-L cabins had dormers, usually over the façade.
- Chimney: Same construction as Single-Pen above.
- Entry Door: Usually in the side-gabled wing, entering the house from a porch in the building's L-shaped plan.
- Windows: Vertical sash windows, often with a 2/2 glazing pattern and wood frames made of 1" or 2" thick milled lumber.
- Porch: An open, narrow porch often extended along the front of the building's L-shaped plan. Floors were wood planks, or, later tongue-in-groove. Shed or low-pitched hipped roof, supported by vertical logs, 4x4" square posts, or turned columns. Some Gabled-L cabins feature porch railings made of small-diameter logs, mill slabs, or dimensional lumber.

Gabled-T Plan Log Cabin – Typical Character-Defining Features

- Core Plan: T-Shaped, cross-gabled roof, usually with a side-gabled front wing and a centered intersecting rear gable. An enclosed shed-roofed rear porch, either original or an early addition, often filled in one of the voids formed by the T-shaped plan.
- Stories: 1½, with small bedrooms in the upper half story.
- Foundation: Low, uncoursed stone foundation. Beginning circa 1900, foundations were often poured concrete or stone with concrete pargeting.
- Walls: Same construction as L-Shaped Cabin above.
- Roof: Cross-gabled, with sheet metal or shingles over 1" plank decking fastened to rafters with collar ties. Later clad with corrugated sheet iron, rolled asphalt, or asphalt shingles. Some Gabled-T log dwellings feature dormers, usually with gable or shed roofs.
- Chimney: Stone chimney or stovepipe, typically on the roof ridge or just below the ridge on the rear slope.
- Entry Door: Often centered in the side-gabled wing, with a separate rear entry door into an enclosed, one-story, shed-roofed rear porch. Wooden door frames were usually made of 1" or 2" thick milled lumber.
- Windows: Vertically oriented sash windows, most often originally with a 2/2 glazing pattern, and with wood frames made of 1" or 2" thick milled lumber.
- Porch: Same construction as L-Shaped Cabin above.

Rectangular Plan Frame Cabin – Typical Character-Defining Features

- Core Plan: Rectangular.
- Stories: 1 or 1½.

- Foundation: Some foundations were log or timber posts, or footers laid on an earthen platform. Others were made of coursed stone, later with concrete pargeting, poured concrete, or concrete blocks.
- Walls: Horizontal planks or horizontal weatherboard siding, over 1" wood sheathing and 2" thick wood framing.
- Roof: Front-gabled or side-gabled with wood shingles, rolled asphalt, asphalt shingles, or smooth or corrugated metal, over 1" wood decking fastened to 2" thick wood rafters with 1" or 2" thick wood collar ties.
- Chimney: Stone or brick chimney or stovepipe.
- Entry Door: Located either under the gable for front-gable plan or beneath the eave for side-gable plan. Entries were usually vertical plank doors, and later manufactured panel doors. Elaborate, paneled doors feature vertical panels, sash lights, and occasionally decorative scrollwork in the rails.
- Windows: Vertical sash windows, often with a 2/2 glazing pattern, and wood frames made of 1" or 2" thick milled lumber.
- Porch: Small plank floor at the entry, covered by an extended roof eave or a gable or shed roof with knee brace supports. Porches are occasionally somewhat larger, with shed or low-pitched hipped roofs supported by 4x4" square posts or turned columns.

Shotgun House (Rectangular Plan Subvariant)

A Shotgun House is a specific design one-room wide, two or more rooms deep, and with entry in the gable end (front). Interior hallways are absent, and the rooms are divided by transverse interior walls and doorways. The front room was usually a parlor, with a kitchen to the rear. Other Shotgun House character defining features are similar to those described above for rectangular plan, wood frame dwellings.

Hall-and-Parlor House (Rectangular Plan Subvariant)

A Hall-and-Parlor plan is two-rooms wide and one-room deep. One room is somewhat larger than the other and typically served as a kitchen and communal living space. The smaller room was a bedroom. Hall-and-Parlor plan houses are covered by side-gable roofs, with the entry door on the side elevation and offset from center. Other character-defining features are similar to those described above for rectangular plan wood frame dwellings.

Gabled-L Plan Frame House – Typical Character-Defining Features

- Core Plan: L-Shaped, with a side-gabled roof over a parlor in main portion, a bedroom in a front-gabled wing, and the kitchen to the rear.
- Stories: 1½, with small bedrooms in the upper half story.
- Foundation: Same construction as Rectangular Frame Cabin above.
- Roof: Cross-gabled in form, clad with wood shingles, rolled asphalt, asphalt shingles, or smooth or corrugated metal over 1" wood decking fastened to 2" thick wood rafters with 1" or 2" thick wood collar ties. Some Gabled-L houses feature dormers with gable or shed roofs, usually over the façade.
- Chimney: Stone or brick chimney or metal stovepipe, typically on the roof ridge or below the ridge on the rear slope.
- Entry Door: Usually located in the main, side gabled wing, in the open area formed by the building's L-shaped plan. Early entry doors were of vertical planks, and later manufactured vertical panel doors. Elaborate panel doors feature upper sash lights and occasionally decorative scrollwork in the rails.
- Windows: Vertical sash windows, most often originally with a 2/2 glazing pattern, in frames of 1" or 2" thick milled lumber.
- Porch: An open, narrow porch extends along the front of the main, side-gabled wing in the void formed by the building's L-shaped plan. Early floors were made of planks, supplanted by tongue-in-groove planks. Shed or low-pitched hipped roofs, supported by 4x4" square posts or turned columns.

Gabled-T Plan Frame House – Typical Character-Defining Features

- Core Plan: T-Shaped, cross-gabled roof, usually with a side-gabled main portion and a centered intersecting rear gable. An enclosed shed-roofed rear porch, either original or an early addition, often filled one of the notches in the T-shaped plan.
- Stories: 1½, with small bedrooms in the upper half story.
- Foundation: Same construction as L-Plan Frame House above.
- Walls: Same construction as L-Plan Frame House above.
- Roof: Same construction as L-Plan Frame House above.

- Chimney: Stone or brick chimney or metal stovepipe, typically on or near the roof ridge of the intersecting rear gable.
- Entry Door: Often centered in the main portion, with a rear door opening into an enclosed, one-story, shed-roofed porch in one of the voids formed by the T-shaped plan.
- Windows: Same construction as L-Plan Frame House above.
- Porch: Same construction as L-Plan Frame House above.

I-House Wood Frame Dwelling – Typical Character-Defining Features

The I-House is an enlarged version of the Hall-and-Parlor plan. The design is two-rooms wide, one-room deep, with a central passage or hallway separating the rooms. Beginning circa 1840, this floor plan proliferated in rural Midwestern states beginning with the letter I (Illinois, Indiana, and Iowa) and became known as the I-House. With a three-bay façade, rather than the two-bay façade of Hall-and-Parlor plan houses, the design presents an illusion of being substantial. I-Houses in Colorado were built primarily in rural areas between circa 1875 and 1910.

- Core Plan: Rectangular
- Stories: 1 or 1½
- Foundation: Same construction as L-Plan Frame House above.
- Walls: Same construction as L-Plan Frame House above.
- Roof: Same construction as L-Plan Frame House above.
- Chimney: Brick or stone chimney, usually centered on the roof ridge.
- Entry Door: Centered in the main portion beneath the roof eave, and entering the central passageway between the two rooms. Early doors are usually of vertical planks, supplanted later by manufactured paneled doors. Elaborate panel doors may feature upper sash lights and occasionally decorative scrollwork in the rail.
- Windows: Same construction as L-Plan Frame House above.
- Porch: Small, often uncovered, plank porch at the entry. Porches typically lack ornamentation, and are often uncovered.

Hipped-Roof Box House – Typical Character-Defining Features

A Hipped-Roof Box type house is a simple rectangular (nearly square) plan covered by a hipped roof. The type is usually slightly shorter across the façade than the length, with typical dimensions of 24'x26', 26'x28', and 28'x30'. The core plan was often modified by the construction of an enclosed, shed-roofed rear mud porch, either as part of the original construction or as an early addition. The Hipped-Roof Box was a dominant type in modest residential neighborhoods and rural areas throughout Colorado into the 1930s.

- Core Plan: Rectangular (nearly square)
- Stories: 1
- Foundation: Same construction as L-Plan Frame House above.
- Walls: Same construction as L-Plan Frame House above.
- Roof: Hipped, often covered with asphalt shingles, rolled asphalt, or smooth or corrugated iron over 1" wood decking boards fastened to 2" thick wood rafters.
- Chimney: Brick or stone chimney, usually centered on the roof ridge or slightly below the ridge on the rear-facing roof slope.
- Entry Door: Entries are primarily manufactured panel doors centered in the front. Elaborate doors feature upper sash lights and occasionally decorative scrollwork in the rail.
- Windows: Vertically oriented sash windows, often with 1/1 or 2/2 glazing patterns, in wood frames made of 1" or 2" thick milled lumber.
- Porch: Small plank floor at the entry, typically covered by a shed or low-pitched hipped roof. Knee brace supports or square wood posts may hold up the porch roof.

Pyramid Cottage (Hipped-Roof Box Dwelling Subvariant)

A Pyramid Cottage is a small, usually square, version of the Hipped-Roof Box house. Its primary defining features are its pyramidal hipped roof, square shape, and minimal ornamentation.

Foursquare House – Typical Character-Defining Features

Also known as the American Foursquare, the Foursquare House is a 2½-story version of the Hipped-Roof Box. Foursquare houses are rectangular (nearly square) in plan and covered by hipped roofs with a hipped-roof

dormer centered on the roof slope overlooking the façade. Foursquares are usually slightly shorter across the façade than in length, with typical dimensions of 28'x30', 30 by 32' and 34'x36'. The core plan was often modified by the construction of an enclosed, shed-roofed rear mud porch, either as part of the original construction or as an early addition. Usually of frame or brick construction, the Foursquare was a dominant housing type in residential neighborhoods, and to a lesser extent in rural areas in Colorado, into the 1930s.

- Core Plan: Rectangular (nearly square)
- Stories: 2½
- Foundation: Same construction as Hipped-Roof Box House above.
- Walls: Horizontal plank or weatherboard siding, over 1" wood sheathing and balloon framing, or brick or sandstone masonry exterior walls.
- Roof: Hipped, often covered with asphalt shingles, or smooth or corrugated iron, over 1" decking boards fastened to 2" thick wood rafters. Some versions feature a hipped-roof dormer centered over the façade.
- Chimney: Brick or stone chimney, usually centered on the roof ridge or slightly below on the rear roof.
- Entry Door: Same door type and location as Hipped-Roof Box House above. Entry doors on masonry Foursquares may be spanned by a sandstone lintel or by a segmental brick arch.
- Windows: Vertical sash windows, often with 1/1 or 2/2 glazing patterns, and painted frames of 1" or 2" thick milled lumber. Windows on masonry Foursquares may feature sandstone lugsills and lintels or sandstone lintels and segmental brick arches.
- Porch: Foursquare houses feature broad front porches covered by low-pitched, hipped roofs, and less often by shed roofs. Frame Foursquares often have tongue-in-groove floors, Tuscan columns or squared posts, and an open or closed railing. Masonry Foursquares may feature tongue-in-groove plank or concrete floors, Tuscan columns, or brick pillars with sandstone capping.

Classic Cottage House – Typical Character-Defining Features

The Classic Cottage is a stylized, 1½-story version of the Foursquare house. It has a rectangular (nearly square) plan, a hipped roof often with flared eaves, and a hipped-roof dormer centered over the façade. Classic Cottage houses are usually of brick or stone masonry, and frame examples are rare. The core plan was often modified with an enclosed, shed-roofed mud porch at rear, either original in construction or an early addition. The Classic Cottage was a relatively common type in both residential neighborhoods and in rural areas throughout Colorado between circa 1905 and the early 1930s.

- Core Plan: Rectangular (nearly square)
- Stories: 1½
- Foundation: Low perimeter walls made of coursed stone or poured concrete.
- Walls: Brick or stone masonry, and rarely frame construction.
- Roof: Hipped with flared eaves, covered with asphalt shingles or rolled asphalt, over 1" wood decking boards fastened to 2" thick wood rafters. Hipped-roof dormer with flared eaves centered over the façade.
- Chimney: Brick or stone chimney, usually centered on the roof ridge or slightly below on the rear slope.
- Entry Door: Manufactured panel doors offset from center. The doors feature vertical panels, upper sash lights, and occasionally decorative scrollwork in the rail. The doorframes occasionally feature transom lights and sidelights. In masonry Classic Cottages, sandstone lintels or segmental brick arches spanned the doorways.
- Windows: Vertically oriented sash windows, often with a 1/1 glazing pattern in painted wood frames made of 1" or 2" thick milled lumber. Windows on brick and stone Classic Cottages may feature sandstone lugsills and lintels or sandstone lintels and segmental brick arches.
- Porch: Classic Cottage houses feature broad front porches with concrete floors, closed knee walls, and heavy, square pillars or Tuscan columns. Those with brick walls usually have brick knee walls and pillars, often with sandstone capping. Porches are usually covered by low-pitched, hipped roofs or are recessed under the front eave of the house's hipped roof.

Bungalow House – Typical Character-Defining Features

Inspired by the Arts and Crafts movement in America and the Craftsman architectural style, the Bungalow is a modest, 1-story or 1½-story version of the Craftsman style house. Popularized by trade journals and magazines, the Bungalow became the most common type of modernistic house built throughout America between circa 1905 and the early 1930s. By 1920, a variety of pattern books provided plans for Bungalow homes, and precut packages could be purchased via mail order and delivered by rail. The Bungalow reached its peak in the early 1920s when

Bungalow Magazine went into publication extolling the virtues of “Bungalow-living.” Numerous Bungalows were erected throughout Colorado’s urban neighborhoods, small towns, and rural areas.

Bungalows feature low, horizontal lines; low-pitched, gabled or hipped roofs; exposed rafter ends beneath widely overhanging eaves; and exposed purlins and ridgepoles, often with knee braces in the upper gable ends. Facades are dominated by a broad stairway leading to a full or nearly full-width front porch. Porch roofs are supported by battered pedestals, topped by large, square-post piers, creating a heavy, horizontal emphasis. Windows are predominantly double-hung with divided (ribbon-style) lights in the upper sash and a single pane in the lower sash. Foundations and walls are often painted warm, natural colors to help tie the dwelling into its natural landscape.

- Core Plan: Rectangular
- Stories: 1 or 1½
- Foundation: Coursed stone or poured concrete, sometimes faced with stone, or painted a warm, natural color.
- Walls: Horizontal wood siding or brick masonry.
- Roof: Broadly pitched, front-gabled, side-gabled, or occasionally hipped, with asphalt shingles over 1” decking boards fastened to 2” thick wood rafters. Eaves extend in long overhang with exposed rafter ends, decorative purlins, and ridgepoles, and knee braces in the upper gable ends. False half-timbering or stick work may appear under the gable ends, which are sometimes clipped. Side-gabled Bungalows often have a low-profile dormer centered over the façade, with a low-pitched gable, hipped, or shed roof.
- Chimney: Brick or stone chimney, usually centered on the roof ridge or slightly below on the rear slope. Many Bungalows also feature a brick fireplace chimney on one side.
- Entry Door: Manufactured panel doors or solid slabs, often stained natural brown. Vertical sash lights are common. Entries may feature transom lights and sidelights. Entry doors on brick Bungalows are sometimes spanned by sandstone lintels.
- Windows: Usually vertical with divided (ribbon-style) lights in the upper sash and a single pane in the lower sash. Frames are painted or stained and made of 1” or 2” thick milled lumber. Window frames on brick Bungalows may have sandstone lugsills and lintels.
- Porch: An open, full-width, or nearly full-width Craftsman style porch is a dominant feature of a Bungalow house. The porch floor may be concrete and feature a set of wide concrete or sandstone steps often flanked by knee walls. The porch is surrounded by a closed brick knee wall, battered brick pedestals, tapered wood piers, and a low-pitched gable roof.

Secondary Support Facility Feature Types

Blacksmith Shop: A building where a settler fabricated and maintained tools and hardware. Simple shops usually featured a blacksmith forge, workbench, and possibly hand-powered appliances such as a drill press or lathe. Blacksmith shops that are no longer intact qualify as archaeological features. If the building collapsed but most of the materials are present, they may be recorded as a blacksmith shop ruin. If the building materials are gone as well, then the leveled earthen footprint on which the building stood is a blacksmith shop platform. Shop platforms may feature forge remnants and artifacts such as forge-cut iron scraps, anthracite coal, and clinker, which is a scoriaceous, ashy residue created by burning coal.

Cookhouse: Companies erected cookhouses at large farms and ranches to feed workforces en masse. A cookhouse was a building, usually vernacular in form, with a large kitchen and dining area. The kitchen often included an institutional cookstove, a brick chimney, counters, and plumbing. If the building collapsed but most of the materials are present, it may be recorded as a cookhouse ruin. If the building materials are gone as well, then the leveled earthen footprint on which the building stood is a cookhouse platform. A foundation for the walls and masonry oven, if one existed, may be present. Artifact assemblages typically include high volumes of food preparation items, tableware fragments, cans, and stove ash, but few general domestic materials.

Domestic Refuse Dump: A substantial concentration of domestic refuse, usually downslope from a residential feature. Domestic refuse dumps consist primarily of food-related and other household artifacts such as food cans, fragmented bottles and tableware, and personal articles.

Domestic Refuse Scatter: A disbursed scatter of domestic refuse, usually downslope from a residential feature.

Garden Plot: To be self-sufficient, homesteaders and ranch families dedicated small plots of ground near the house for growing produce. The plot was fenced, and soils were rich and well cultivated. If the fence no longer stands, it may be represented by postholes, vegetation, or raised earthen berms.

Icehouse: Ranchers used icehouses both to store ice for warm months and as primitive refrigerators. Icehouses usually were countersunk into the ground and consisted of stone masonry for insulation, and they featured storage shelves. Collapsed icehouses may be recorded as ruins.

Privy: A building that served as a toilet facility. Privies stood over pits, were around 4'x5' in area, and featured a bench with a cut-out as a toilet seat.

Privy Pit: Privy pits manifest as minor depressions surrounded by backdirt and may retain footers from the privy structure.

Root Cellar: Root cellars were independent structures used for food storage. They often manifest as small dugouts with earthen roofs and façades of rocks, logs, or lumber. When collapsed, a root cellar may be recorded as a root cellar ruin.

Smokehouse: Ranch families preserved meat by jerking and smoking in small, insulated buildings. Windows were few, and the buildings had drying racks, chimneys, or stovepipes.

Spring House: When possible, settlers relied on springs for drinking water because of their purity. The settler erected a small masonry or frame enclosure over the spring to keep out debris, and provided an outlet for overflow water. The enclosure usually had a gabled or shed roof. Collapsed remnants of spring houses may be recorded as ruins.

Storehouse: Storehouses were small buildings of lumber or logs for the storage of goods other than food. Collapsed remnants of storehouses may be recorded as ruins.

Well: Where surface water was unavailable, settlers sank wells to supply domestic needs. Early wells are circular and usually lined with open masonry. Later wells were pipes with hand pumps.

Woodshed: Because wood was a primary heating and cooking fuel, a supply kept dry in a shed was critical. Sheds were small, of log or frame construction, and may have been open. Wood scraps and sawdust should encompass the structure, if no cordwood remains. Collapsed remnants of woodsheds may be recorded as ruins.

Wood Stack: A stack of cordwood.

Work Platform: An intentionally graded flat area for domestic activities such as laundry, chopping wood, and butchering meat.

Livestock and Crop Storage Facility Feature Types

Barn: A barn was a multipurpose building that housed fodder, tack, agricultural equipment and tools, and draft animals. Depending on location and era, settlers used logs, lumber, or a combination for walls and roofs. Large barns had at least lumber roofs, if not lumber walls. Most were drafty and had wide doorways and lofts. If the barn collapsed but most of the materials are present, they may be recorded as a barn ruin. If the building materials are gone as well, then the leveled earthen footprint on which the barn stood is a barn platform. They may feature a large area, manure deposits, and artifacts such as agricultural hardware and tack.

Chicken Coop: Chicken coops were usually small, made of lumber, divided into shelves, and had one open face. A chicken run fenced with chicken wire surrounded the coop.

Corral: Corrals were fenced enclosures that impounded cattle and draft animals, usually adjacent to a barn or stable. Fences often consisted of logs or wire. If the fences collapsed or are represented by posts and alignments of postholes, the corral may qualify as a corral remnant.

Dehorning Cage: Cowboys cut the horns off some cattle, and because the cattle strenuously protested, they were held fast in cages. Steel braces engaged by a lever clamped the head and steel combs pressed down on the body. The cage was at the end of a narrow chute that linked two corrals.

Feed Trough: Feed troughs contained fodder for draft animals and cattle, and they were usually located in a corral. Most troughs were V-shaped, 3' wide, as deep, and 6' to 8' long.

Grain Shed: Settlers erected grain sheds to store grain in bulk form. They were shed or gabled in form and of frame construction with plank siding on the interior face. Inside, the shed was divided for different grain types. If the shed collapsed, it can be recorded as a grain shed ruin.

Loading Chute: By the 1930s, farmers and ranchers used trucks to haul cattle either to market or to a railroad shipping point. Inclined ramps with fenced sides directed cattle into the trucks, and they were connected to corrals.

Milking Barn: Dairy products were an important source of income for many farms, and cows were milked in buildings known as dairy barns, milking barns, and milk houses. Most milking barns were of frame construction and sided with planks or, by the 1950s, corrugated sheet iron. The interiors were designed to be washed and featured stalls lined with sheet iron, as well as concrete floors with drainage systems. The collapsed remnants of a milking

barn may be recorded as a ruin, and if most of the structural material is gone, then the concrete floor qualifies as a foundation. The floors often feature raised dividers marking the stalls, drains, and channels to shunt rinse water.

Potato Cellar: Potato cellars, similar to bunkers, were countersunk into the ground, lagged on the interior with planks, and covered with earth. The cellars were at least 8'x10' in area with broad doorways. Collapsed potato cellars can be recorded as ruins.

Poultry House: Some farmers raised chickens and turkeys in commercial numbers and kept the fowl in elongated frame buildings. The interior featured two or more rows of cubicles for the birds usually on concrete floors. The structures were shed or gabled in form and based on lumber frames sided with planks or, by the 1950s, corrugated sheet iron. Collapsed remnants may be recorded as ruins, and the concrete floors qualify as foundations.

Rabbit Hutch: Rabbit hutches were small sheds elevated on legs with an open face of chicken wire. The interior was divided into several cells for rabbits.

Refuse Dump: Settlers cached debris, old structural material, surplus fencing, and obsolete equipment in scatters near the barn.

Silo: Silos were tall, cylindrical structures at least 8' in diameter for the storage of bulk grain. Most were made of masonry or concrete, and a few were of planks bound with steel hoops. One side had ports for loading and unloading grain. Because of their size and weight, silos required foundations of masonry or concrete, which have circular footprints. Such features can be recorded as silo foundations.

Stable: Horses were a principal means of transportation around ranches, and they were housed in stables separately from common livestock. Stables were similar to but smaller than barns. Their interiors were divided into stalls with feed troughs, and lofts for the storage of fodder. The collapsed remnants of a stable may be recorded as a ruin, and when most of the structural debris is gone, the earthen footprint qualifies as a stable platform. Outlines of the walls, manure deposits, and postholes for the stalls are often evident.

Tack Shed: A small building in which settlers stored tack and hardware for managing animals. Tack houses were usually shed in form and of logs or lumber. The interior should feature nails and hooks for hanging tack and shelves for tools. When collapsed, the tack shed can be recorded as a tack shed ruin.

Water Trough: Water troughs were usually located in corrals, and they provided livestock with water. They consist of planks, are usually 3' wide and as deep, have flat bottoms, and a feed pipe.

Well: Where surface water was unavailable, settlers sank wells to provide water for livestock. Most wells were pipes with pumps.

Windmill: A windmill featured a fan atop a tower that stood over a well. The fan powered a pump via linkage hardware. Prior to the 1890s, the towers were made of timbers, and afterward, of steel. Windmills provided water to livestock or for crop irrigation. Collapsed remnants of windmills are ruins.

Rural Historic Agricultural Landscape Feature Types

Fence: Fences were erected to control the movement of livestock and to define property boundaries. Prior to the 1890s, log rail fences were common, and afterward, wire and barbed wire were common. Isolated posts, postholes, and linear cobbles or vegetation may represent abandoned fence lines.

Field: A field dedicated to growing crops. Cultivated fields were usually fenced, plowed, irrigated, and cleared of rocks, which were thrown in piles along the edges.

Irrigation System: Systems of supply ditches delivered water to a crop field, and lateral ditches distributed the water over the field. Supply ditches may have captured water from nearby streams or may have been filled from wells. Early ditches were channels in the ground, and by the 1940s, growers increasingly lined them with concrete to prevent seepage. Gates admitted the water into lateral ditches.

Livestock Path: When livestock wandered a landscape, they often followed the same routes between areas of shelter, feed, and water. Over time, the traffic created distinct trails similar to graded footpaths.

Natural Landscape Features: Rural landscapes usually possess natural features such as rock outcrops, historic groves of old-growth trees, steep slopes, and areas of unaltered vegetation or ground.

Open Range: Open range was unimproved, often fenced, and dedicated to feeding livestock.

Orchard: Farmers who grew fruit in commercial volumes planted rows of trees bordered by fences and access roads.

Pasture: A field dedicated to growing hay for forage by livestock. The fields were usually fenced, plowed, and cleared of rocks. Pastures often featured facilities for moving cattle, such as corrals and loading chutes.

Road: Roads were components of circulation systems and facilitated the movement of people, wagons, and equipment. Within farms, ranches, and homesteads, roads linked fields and support facilities. Abandoned roads may be represented by raised beds, linear vegetation patterns, and cuts.

Rock Pile: When growers cleared fields of rocks during plowing, they usually piled them on the edges of the field. The presence of a rock pile in an overgrown and abandoned field indicates that it was cultivated.

Spring: Springs were important sources of water in rural landscapes and issued from subsurface geological features. When in a natural state, a spring is often surrounded by cottonwoods or willows and lush grass. In many cases, homesteaders and ranchers developed springs for livestock. Such springs may manifest as a pool in an excavation, possibly with adjacent water troughs or springhouses.

Stock Pond: Settlers and ranchers excavated large depressions in drainage floors to collect water for livestock.

Vineyard: Farmers who grew grapes in commercial volumes planted rows of grapevines supported by rows of stakes and trellises. Vineyards were often bordered by fences and access roads. Rows of stakes and knotty stumps may remain from abandoned vineyards.

Streams: Landscapes often featured drainages that carried permanent streams. Some segments were unaltered while agricultural operations modified others for livestock or water diversion.

Well: Where surface water was unavailable, growers sank wells to provide water for irrigation. Most wells were on the edges of fields and featured pipes with pumps.

Wellhouse: A small frame building that enclosed a well and pump, usually on the edge of a field. Wellhouses were made of lumber, brick, or stone masonry.

Windmill: See livestock and crop storage.

Windmill Ruin: See livestock and crop storage.

Section B 4: Electric Power Property Types and Registration Requirements

Historic resources left from the power industry can be expected throughout the I-70 corridor. Some are still in use, others are abandoned, and most have been dismantled and now manifest as archaeological sites. It should be noted that archaeological sites have as much potential for significance as intact facilities. Nearly all the power plants, their infrastructures, and substations were built at corridor towns and mines rather than remote areas in between. Other types of power-related resources, such as electrical lines, water systems, and reservoirs, can be found anywhere in the corridor. When isolated, these resources should be traced to their parent systems and evaluated for significance in this context. During the 1960s and 1970s, Public Service modernized portions of the grid by replacing aging equipment, structures, and buildings. Although this may impact a given resource's character-defining attributes, the resource may be eligible if integrity sufficiently conveys significance. If a resource is less than fifty years old, it may qualify for nomination under a later Period of Significance as time passes and this context is updated. The resource can also be evaluated under NRHP Criterion Consideration G, recognizing exceptionally important properties that achieved significance within the last fifty years.

Section B 4 defines historic electrical generation resources common to the I-70 corridor and their registration requirements. Itemized descriptions of archaeological, structural, and architectural features are offered at the section's end to refine resource interpretation. Appendix VI in *National Register Bulletin 16A: How to Complete the National Register Registration Form* provides guidelines for recording electrical systems, power plants, their pipelines, and dams. The bulletin is available at History Colorado and the National Park Service.⁶⁹⁴

The following Property Types are developed in this section:

- Powerplant Site
- Substation
- Powerline
- Infrastructure Components
- Reservoirs

PROPERTY TYPE: POWER PLANT SITE

Power plants were fundamental to every electrical system because they generated current and directed it onto a network of transmission lines. Most power plants were individual, free-standing buildings whose sizes were proportionate to their generating capacity. Small plants were similar in size to today's single-family residences, featuring at least one generator also known as a dynamo, its motive source, a switchpanel, electrical transformers, and wiring. High-capacity plants were multistory edifices with rooms for two or three dynamos, multiple transformers, and switchpanels.

Generating facilities employed two sources of motive power to turn their dynamos. From the 1880s through the 1910s, most electric and mining companies preferred hydropower because

⁶⁹⁴ *National Register Bulletin 16A: How to Complete the National Register Registration Form*. National Park Service, 1997 [1977].

water was abundant and relatively inexpensive. The companies merely provided capital for the power plant and hydropower infrastructure, allowing the water to do the work. By the 1890s, electric companies installed steam engines for backup in hydropower plants, and even used steam exclusively at a few plants.

In hydro plants (see Illustration B 4.1), a carefully engineered infrastructure system delivered the water under pressure to the power plant for generation. Inside, a high-pressure water jet played against a bronze or iron waterwheel belted to a dynamo. The infrastructure system began with a diversion structure, capturing flow from a stream or reservoir outlet higher in elevation than the plant, and sometimes miles away. Screens removed coarse debris, and the water flowed into a flume or large-diameter pipeline. Immediately above the plant, the pipeline or flume emptied into an exchange structure known as a pressure box. Most pressure boxes were at least 4'x6' in plan and as high, assembled with concrete or timbers, with an inlet at the top and a penstock leaving the bottom.

The penstock was the final pipeline to the hydro plant, delivering water under pressure. Descent downslope increased the water current's force, and a series of diameter reductions boosted the velocity. As the pipeline approached the powerhouse, it became horizontal and then forked. One branch drained the penstock for maintenance, and the other was a live line passing underneath the power plant's floor. Inside the plant, the line entered a narrow channel featuring the waterwheel and ended with a nozzle playing a jet against the wheel's cups. The channel was a fully enclosed masonry or concrete slot with a splash-guard preventing spray from soaking the powerhouse interior. The waterwheel was geared to a solid driveshaft rotating in heavy bearings, and the assembly was bolted to concrete or masonry pylons. Either a canvas belt, a drive-chain, or gearing transferred motion from the driveshaft to the dynamo, bolted to another, nearby pylon. Large powerhouses had multiple waterwheels and dynamos, each with its own foundation pylon. Electricity went to an interior transformer station and then switchpanel, and finally out the building to a substation (see Substation Property Type).

In the Rocky Mountains, most electricity providers found that winter presented significant problems for hydropower operations. Severe cold often froze water sources, pipelines, and valves, and interfered with generation. In response, the companies installed steam engines in their hydro plants as a standby in the event the water system failed. A few power plants relied exclusively on steam as a motive source, such as the Seaton Mountain facility rebuilt in 1901 at Idaho Springs. In such plants, a steam engine turned a main driveshaft usually through a chain-drive or gearing. The driveshaft then powered one or more dynamos through the same coupling as hydro plants. Small steam plants had single-cylinder, straight-line engines; large facilities used dual cylinder duplex engines, and both models were bolted to stout concrete or masonry foundations. One or more boilers supplied the steam, and they were usually sequestered in a separate room to keep the engine and dynamos free of grit. Boilers required bins for coal and plumbing systems for feed water. Return-tube boilers were universal, although large power plants such as the United Light & Power facility built in 1900 at Georgetown had water-tube boilers because of their efficiency.⁶⁹⁵ As can be inferred from above, power plant design was complicated, drawing from several disciplines including fluid dynamics and electrical, mechanical, and structural engineering. An understanding of architecture was also necessary because the generating system required a powerhouse building, and ancillary outbuildings.

In general, powerhouses were professionally designed, often by the system engineer, and assembled with standard materials such as dimension lumber, factory-made hardware, and

⁶⁹⁵ *Georgetown Courier* (8/4/1900) p3 c4.

commercial sheet iron. Each building was a custom design reflecting the engineer's interpretation of how best to meet the needs of a specific plant. The engineer adapted structural elements and other aspects of industrial architecture to the configuration and size of the generating system. As a building type, powerhouses can be described as industrial vernacular in design, form, and appearance. Vernacular refers to adaptation of familiar design and construction principals to the specific needs of the plant, available materials and equipment, and the immediate environment. Such buildings tended to express the builder's financial resources, skills, and experience.

Although no two powerhouses were identical in the I-70 corridor, all shared a few general characteristics. In materials, early buildings consisted of wood framing and plank siding, and sheet-iron siding by around 1900 because of its fire resistance. In form, small powerhouses tended to be rectangular with gabled roofs, multiple vertical windows, and broad doorways. Large versions featured extensions for equipment, storage, and an office (see Illustrations B 4.2 and B 4.3). Hydro facilities were always located at the base of a slope so gravity could pressurize the penstock, and steam-powered plants had smokestacks for the boilers. The buildings usually stood on well-graded platforms, with walls resting on impermanent foundations such as timber footers. But because of its weight, movement, and horizontal stress, the machinery was almost always anchored to masonry or concrete foundations. Each piece of equipment had its own distinct pylon, whose footprint corresponded to the machine's bedplate. The tops of the foundations were usually the same in elevation so a plank floor could surround the entire assemblage.

In some cases, mining companies operated power plants that were too small and simple to justify their own buildings. These in-house power plants were no more than a dynamo installed in a mill, and they were usually coupled to the mill's steam engine. At some mines, such as the Stanley near Idaho Springs, the dynamo was in the compressor house and belted to an existing steam engine.

Nearly all the power plants in the I-70 corridor were dismantled when retired, except for the Shoshone (1909), Georgetown (1900), and Cabin Creek (1964) facilities, and are now represented primarily by archaeological features. Ditches, pipeline beds, concrete pylons, and cisterns often remain from water systems. Earthen platforms and wall footers typically outline powerhouse building footprints. Within these, dynamo and steam engine foundations manifest as concrete or masonry blocks, and channels reflect the waterwheels. Mounds of scorched brick surrounded by coal and clinker denote the location of steam boilers. Powerhouses also left distinct industrial debris such as electrical hardware, plumbing, and large pressure fittings.

PROPERTY TYPE: SUBSTATION

All electrical systems relied on substations, also known as transformer stations, to convert current generated by powerhouses. In general, substations converted voltage and current in an inverse relationship for either transmission or consumption. Thus, substations were usually located at both ends of a transmission line and at distribution points in between. Most power plants featured a substation where the system's transmission lines began. Step-up transformers increased voltage and reduced current for long-distance transmission over the main lines. At key points on the lines, more substations converted the current for distribution to consumers. There,

step-down transformers decreased the voltage and increased the current, sending the power to points of use over distribution lines. For systems with extremely high voltage, such as the Shoshone line, a series of substations converted the power for consumption. In general, a transformer consisted of an oblong casing around current-conversion equipment. Sizes ranged from around 1'x2' in area and 3' high to 2'x4' in area and 8' high. Early transformers featured plank casings, by 1910 they had cast iron shrouds, and later versions were ribbed or fluted to dissipate heat. Most included mounting brackets and insulated wire couplings.

Substations varied in size, configuration, and equipment according to service area. Transformers accomplished the conversion at nearly all substations, and their number depended on voltage, current, and distribution lines. At small facilities, utility poles carried a transmission line to several transformers, and distribution lines sent the reduced voltage to consumers. Early substations featured the transformers in a shed, while substations built after around 1930 featured the transformers on a frame mounted to utility poles. At large substations, a transformer house enclosed multiple transformers, circuit-breakers, and a switchpanel. Large facilities also had arrays of utility poles and occasionally storage sheds for transformer fluid and electrical supplies. When a substation is part of a power plant site, the substation would not be an independent property type in itself, and instead belong to the encompassing power plant complex. Substations presently exist the I-70 corridor, many having been improved or replaced within the last fifty years. Although alterations could impact integrity, a resource may be eligible if its design and a majority of equipment dates to a Period of Significance and conveys significance.

PROPERTY TYPE: POWERLINE

Powerlines were fundamental to the operation of any electrical system. They carried electricity from the power plant to substations, and then distributed the current from those stations to consumers throughout a provider's service area. Powerlines should be recorded as linear resources because of their length and configuration.

Powerlines can be divided into categories of transmission lines and distribution lines. Transmission lines were main arteries carrying high-voltage electricity from a substation at the power plant across an electric company's service territory. At line's end, and points between, step-down substations drew current from the transmission line and converted it to a lower voltage for use. Distribution lines then carried the reduced current through concentrations of consumers. Tap lines connected each consumer with the distribution line, and in later years, a small transformer served as the physical junction. Both transmission and distribution lines were engineered structures assembled with factory-made parts. Because of their importance and function, transmission lines were often professionally designed by an electrical engineer and constructed according to planned specifications. Distribution lines may have been professionally designed or planned in the field in response to immediate conditions and needs.

Power companies built transmission lines according to specifications different from distribution lines. For small-scale systems such as those in Clear Creek and Summit counties, a typical transmission line consisted of tall poles crowned with cross-members reinforced with iron brackets. The cross-members featured high-voltage glass, or, after around 1900, porcelain insulators screwed to wooden pegs. Solid copper wires, lashed to the insulators, carried the electricity. One transmission line may have actually featured three or four wires and their insulators. To protect the system from storm lightning, several grounding wires were pinned to

the wooden cross-members in hopes that they would intercept strikes. The poles were often numbered with tags, some with date nails featuring the last two digits of the year when erected.

Large-scale systems, such as that for the Shoshone power plant, transmitted the electricity in very high voltages, requiring lines superior in materials and construction to local systems. The towers were steel constructs bearing weight of heavy cables and withstanding strong wind shear. The wires consisted of copper cables braided around hemp cores, and they were anchored to the towers with chains of disk insulators. In the I-70 corridor, Central Colorado Power Company installed such towers when it began building the Shoshone system in 1907, and United Hydro-Electric Company replaced wooden poles with steel on its line from Georgetown to Lamartine in 1910. Although the general function changed little and steel continued to be used, most if not all early towers were replaced with those in existence today.⁶⁹⁶

Distribution lines were similar in design and materials to the small-scale transmission lines described above. But distribution lines had several distinguishing characteristics. One was a greater number of cross-members and individual wires. Each wire served a local zone of consumers, such as a city block or a heavy power user like a mine or mill. Another difference was that distribution lines featured connections at many of the poles for tap lines, which descended to individual consumers. Last, the cross-members also carried telephone lines.

PROPERTY TYPE: INFRASTRUCTURE COMPONENTS

Infrastructure components are a broad resource category including constructs and facilities other than power plants, substations, and powerlines, in direct support of building and operating an electrical system. Most components were concentrated around power plants because these facilities depended on an infrastructure to generate and transmit electricity.

Infrastructure components can be divided into two categories. In one, the components are individual pieces of larger systems. Infrastructure systems associated with the power industry can include water collection and distribution, roads and bridges, and steam. Ditches, pipelines, and penstocks, for example, are components in themselves but are more important as aspects of a hydro plant water delivery system (see Illustration B 4.4). In such cases, components of a system should be recorded and evaluated in the context of the greater infrastructure to which they belong. The second category of infrastructure components includes independent facilities serving the overall electrical system. Offices, storehouses, machinery, and equipment yards are examples.

Nearly all components of infrastructure were purposefully constructed to fulfill a specific role in an electrical system. Some components were professionally designed by an engineer and assembled with standardized building materials and factory-made hardware. Often, the same components were integral with a larger system. Pipelines and headgates are examples, and they were usually parts of greater water systems. Other infrastructure components, usually small-scale structures, were vernacular in that they were assembled with available materials in the field by experienced workers to fulfill an immediate need. Solitary objects and structures, such as poles, fences, and signs, can qualify as independent resources unless associated with a larger site. In such cases, they should be recorded as features of their associated complexes. The researcher should refer to the feature descriptions at the section's end for a list of infrastructure components.

⁶⁹⁶ "Current News" *Mining Science* (9/1/10): 211.

PROPERTY TYPE: RESERVOIR

Hydropower plants were only as reliable as their water source. Initially, electric companies attempted to secure water directly from constantly flowing streams, but drought and freezes quickly proved this insufficient for plant reliability. In response, nearly all companies in the I-70 corridor constructed reservoirs to impound water for a constant, all-year flow. The Central Colorado Power Company and several independent mining companies were exceptions. The mining companies ran small power plants requiring little water, and they found that directly diverting large streams provided them with enough. Central Colorado originally planned a series of reservoirs for its Shoshone plant, but it settled for the Colorado River's natural flow.

Most of the electric companies built two types of reservoirs. One was modifying and adapting existing lakes because they already were natural storage basins. Modifications focused on increasing storage capacity by raising the water level, and improving outflow for deeper discharge. Low dams of earth and rock rubble across the lake mouth sufficiently elevated the water level, and with little engineering and capital. A concrete or masonry spillway may have been the only professionally designed portion of the dam. The natural outflow channel was deepened to give the entire water body a greater head to draw from. The channel passed underneath the dam and may have been improved with more concrete or masonry and a gate valve. The channel mouth, below the dam, may have had a diversion structure that split the outflow between the power plant's water system and the original stream bed. Sometimes, the diversion structure was far downstream because of the water system's engineering requirements, or if the power plant lacked senior water rights. Between 1900 and 1905, the United Light & Power Company modified Clear, Green, Murray, and Silver Dollar lakes above Georgetown. It should be noted that not all lakes with improved outlets in the I-70 corridor were for power plants, as some were harnessed for other uses.⁶⁹⁷

Artificial water bodies were the second type of reservoir, and they were smaller than natural lakes. The power companies secured a suitable drainage featuring a natural constriction with an open area behind and built a dam in the constriction. The dams were often earthen berms retained on the inside with rock rubble or log cribbing. A ditch delivered water, captured elsewhere, to the reservoir's head, and an outlet channel directed release flows into the original drainage. The channel, extending under the dam, was often a box culvert lined with concrete, masonry, or planks. Its intake was a drain fitted with debris screens and a gate valve at the dam base. Artificial reservoirs tended to be small because power companies lacked the funds for dams with enough structural integrity to impound high volumes of water.

ELECTRIC POWER PROPERTY TYPE SIGNIFICANCE

Although power plants, substations, powerlines, infrastructure components, and reservoirs are described as individual Property Types, they constituted electrical systems in the I-70 corridor. Every system included most if not all these Property Types, none functioning without them. In overview, power plants generated the electricity, and substations converted it either for transmission or use by consumers. Powerlines carried electricity as generated through

⁶⁹⁷ Colorado Power Company. "General Description of Reservoirs, Pipe Lines, Generating Stations, and Substations and Transmission Lines" Manuscript WH 1367, Box 1, Folder FF55, Denver Public Library. 1920, 4; Gidlund, H.F. "Public Service Co. of Colorado: History and Plant Information." Manuscript WH 1367, Box 1, Folder FF5, Denver Public Library. 1925.

the corridor, and distributed an adjusted current to consumers. Infrastructure components provided support for entire electrical systems or their individual facilities and delivered water to hydro plants. Reservoirs contained reliable sources of water for hydro plants, which generated most of the electricity in the corridor.

The electrical systems and their Property Types were important in the following Areas of Significance: Architecture, Economics, Engineering, Industry, and Invention. As parts of greater electrical systems, the Property Types also share the same general registration requirements. The Period of Significance 1883 to 1962 covers electrical generation as a theme throughout the corridor. But the industry's history was not uniform, and narrower Periods of Significance are more applicable to specific regions: 1883 to 1962 in Clear Creek drainage, 1898 through 1936 in Summit County, and 1906 to 1962 along the Eagle and Colorado rivers. Level of significance will be local, although some resources may be statewide or national, depending on further research.

Area of Significance: Architecture: Electric generation resources with standing buildings may be important in the Area of *Architecture* for several reasons. In erecting power plants and associated service buildings, engineers adapted familiar industrial architecture practices and concepts to meet the needs of generating power and running an electrical system. They responded to topography, natural landscape features, local climate, and available financial resources and buildings materials. Most powerhouses were custom-designed but followed a general template characteristic of their type (see powerhouse descriptions above). In service buildings, engineers adapted familiar forms and methods but added features to fulfill required functions and duties, such as insulator brackets and powerline ports in walls. By constructing these types of buildings, engineers contributed to patterns of functional and yet cost-effective industrial architecture in the mountains.

Area of Significance: Economics: Electrical systems were significant in the Area of *Economics* because they directly supported industry and the income it generated. Between 1883 and 1910, electricity increasingly benefitted mining and dependent industries, the financial cornerstones of Clear Creek and Summit counties. With electricity, mining and milling companies were able to convert greater tonnages of ore into wealth over a longer period of time. When the Shoshone system was brought on line in 1910, it not only continued to support mining in Clear Creek and Summit counties, but now Eagle and Lake counties as well. Because this trend affected such a large area, level of significance might be statewide depending on further research. The mining industry underwent a substantial revival during the Great Depression due to increases in the values of gold and silver. Electricity underwrote the revival and allowed mining companies to convert ore into income, desperately needed in the counties at the time. The contribution was also important to Colorado's economy, which suffered due to the poor economic climate.

Electricity supported other industries and commercial business. On a local level, manufacturing, equipment servicing, and a tourist trade, as examples, followed trends similar to mining. When the Shoshone grid was completed to Denver in 1911, it fostered industry and business throughout central Colorado, and the cumulative economic impact was substantial.

Reservoirs were involved in a separate set of economic impacts. Although built to serve powerplants, reservoirs supported other forms of business that contributed to diversified local economies. In particular, reservoirs were used for recreation such as fishing, camping, and resorts. Their reliable water also supported industry such as mining, logging, and manufacturing.

Areas of Significance: Engineering and Invention: Some electrical systems were important for their participation in the development of electrical engineering and technology. Systems predating 1910 were built at a time when electrical engineering, and especially hydropower, was in a nascent state of development. Further, engineers grappled with difficult environmental conditions including hostile terrain, an undeveloped landscape, high winds, and arctic winter conditions. By functioning correctly in an adverse environment, the systems contributed to the empirical body of knowledge regarding plant design, equipment, operations, and associated infrastructure. This was especially true of DC systems predating 1900, AC systems predating 1910, and the Shoshone power plant, completed in 1909.

The Shoshone plant contributed to the development of large-scale hydropower projects and knowledge regarding extensive electrical systems. The Shoshone system was the largest in the state for its time, generated the second-highest voltage in the nation, and required adaptation of existing technology to withstand the environmental rigors of the Rocky Mountains. The powerline and substations joined the system with independent grids in Summit and Clear Creek counties, Leadville, Denver, and Boulder. In so doing, they contributed to the development of grid unification. The powerline was a major engineering accomplishment in itself. The route crossed some of the most rugged topography attempted, required exacting surveying, and had to be carefully planned. In addition, the cable had to carry an unusually high voltage and withstand extreme winds. To this end, the Central Colorado Power Company invented a special steel cable with couplings for use over high mountain passes. Conventional transmission cables, copper wound around hemp cores, proved inadequate for mountain conditions.

Prior to 1900, water system engineering for hydropower was in a nascent state of development. Similarly, the use of steam engines to run the dynamos in a power plant was still being developed. By functioning correctly, water and steam systems contributed to the empirical body of knowledge of how to keep a power plant running in a constant and reliable nature. This was particularly important in the West, where water was scarce and had to be carried great distances to the power plants.

Area of Significance: Industry: Electrical systems made numerous contributions in the Area of Industry. Benefit to mining is one of the most important. Electricity lowered the cost of ore production at the mines, and as a result, companies were able to extract lower grades of payrock than before. Similarly, electricity reduced the costs of ore treatment in the mills, which were then able to accept the low-grade payrock. The net result was a prolonged mining industry, which was the economic foundation local to Clear Creek and Summit counties until approximately 1920. Electricity directly fostered a revival of mining during the Great Depression, and the industry had an important impact throughout the central mountains during this time. When the industry revived, it provided numerous jobs and economic contributions in an era when these were in short supply and dearly needed. Electricity available from the grid underwrote the revival because many mining operations relied on the power source to run machinery. The grid provided service to mines throughout the central mountains, including Clear Creek, Eagle, Lake, and Summit counties.

Besides its impact on mining, electricity dramatically improved other forms of industry, commercial business, and the quality of life. Prior to unification of grids in Clear Creek and Summit counties with the Shoshone system, the impact was on a local level. When the grids were connected with the Shoshone system, the impact increased in geography.

Electric Power Property Type Registration Requirements

To qualify for the NRHP, electric power resources must meet at least one of the Criteria listed below and possess adequate physical integrity to convey their significance.

Criterion A: Resources eligible under Criterion A must be associated with at least one Area of Significance noted above as well as contribution to a broad pattern of history.

Criterion B: Electric power resources may be eligible under Criterion B provided an association with the life of an important person significant in our past. Presence will probably be through employment, operations management, or construction. The resource must retain physical integrity relative to the person's productive life. A brief biography is necessary to detail the individual's significant contributions. Important people invested in power companies or owned property, but did not personally occupy a site. Such an association does not meet the registration requirements for Criterion B. The individual of note must have been present on-site.

Powerplants are the most likely resource to qualify because they were workplaces where individuals spent periods of time. The other Property Types are less likely to qualify because establishing a direct association is more difficult. Construction of a facility is the principal exception, providing that the individual was personally involved on-site. In general, applying Criterion B is complex, and *National Register Bulletin 32: Guidelines for Evaluating and Documenting Properties Associated with Significant Persons* can provide further guidance.

Criterion C: A resource may be eligible under Criterion C when it clearly embodies its Property Type and possesses integrity relative to one of the Periods of Significance. Because most equipment and buildings were removed when a facility was retired, integrity is usually on an archaeological level. A site retains sufficient integrity on an archaeological level when the material evidence clearly conveys function, overall design, structures and equipment, operations, and timeframe. Intact buildings, structures, and machinery are rare and important, and may qualify individually as examples of engineering, technology, and architecture specific to early power generation. For a site to be eligible, it should possess character-defining attributes even if on an archaeological level.

At *power plants*, the dynamos, their motive source, and drivetrain should be discernible from intact components or their archaeological manifestations. For hydro-plants, this includes the water system, waterwheel channels, and machinery foundations. For steam plants, the engine, boiler, dynamo, and driveshaft foundations are included. The powerhouse footprint and indication of associated facilities should be interpretable.

At *substations*, sufficient integrity requires either equipment and structures older than fifty years, or their clear representation through distinguishable archaeological evidence. The locations of utility poles, transformers, other electrical equipment, and buildings, if any, need be identifiable.

For *powerlines*, integrity requires a series of utility poles older than fifty years, representing the design, engineering, and function of a power transmission or distribution system. If a powerline has been dismantled, the archaeological evidence is usually insufficient to represent the Property Type.

Infrastructure components must be older than fifty years and convey their design, engineering, and function. In the case of water systems, the diversion structure, pipeline or flume route, pressure box, and penstock route should be discernible. In the case of small-scale components, the facility, its function, and relationship to the electric system should be identifiable.

For *reservoirs*, the resource must clearly represent improvements made for water storage and diversion. Included are the water inlet, basin, dam, outflow, and diversion structures. The Property Types may also be eligible if they are contributing elements of historic landscapes. When in an urban setting, nearby buildings and structures should be similar in age, and the Property Type should contribute to the community's historic feeling. When in a mining district, the Property Type, or its archaeological remnants, should contribute to the feeling of industry imparted by surrounding resources.

Criterion D: Property Types may be eligible under Criterion D if they are likely to yield important information upon further study. If a site possesses structures and buildings, detailed examination may reveal how engineers adapted architecture or engineering to generate, convert, or convey electricity in difficult, high-altitude conditions. *Power plant* sites predating 1910 could contribute to knowledge of early plant design, technology, operations, and equipment. *Substations* and *powerlines* may reveal information about early electrical current transmission, conversion, and distribution. Electrical system and grid interface is another arena of inquiry. *Infrastructure components* can contribute to facility planning and organization, routing electricity, and the support facilities required for an electrical system. Intensive studies of water systems and reservoirs may enhance the existing knowledge of early diversion, distribution, storage, and hydropower generation.

Eligible Property Types must possess physical integrity relative to their regional Period of Significance. In some cases, system components were dismantled when a facility was retired, leaving archaeological evidence. Integrity on an archaeological level is sufficient when material evidence clearly represents the facility, its operation, timeframe, and significance. In other instances, Public Service may have replaced aging equipment, structures, and buildings, impacting integrity. A resource may be eligible if present character-defining attributes convey its significance. Common Property Type features and character-defining attributes are at the section's end.

Most of the seven aspects of integrity apply to the Property Types, although not all need be present. Intact buildings, structures, and machinery must be in their original places of use to retain integrity of *location*. For a resource to retain integrity of *design*, the material remains, including archaeological features, must convey the facility's organization, planning, and engineering. To retain integrity of *materials*, the structures and machinery should date to a Period of Significance. To retain integrity of *setting*, the area surrounding the resource must not have changed a great degree from its operational timeframe. If the resource is isolated, then the natural landscape should be preserved. If the resource lies in a mining landscape, then the surrounding mines and industrial features should retain integrity at least on an archaeological level. If the site lies in an urban setting, then adjacent buildings and structures should be compatible in age. In terms of *feeling*, the resource should convey the perception of its function from a historical perspective. Integrity of *association* exists where structures, machinery, and archaeological features convey a strong connection between the resource and a contemporary observer's ability to discern its historic function.

ELECTRIC POWER SITE FEATURES

Powerplant Feature Types

Hydropower System Features

Hydropower plants depended on water to generate electricity, and a system of ditches, pipelines, and other structures to deliver the water. A variety of structural and archaeological features currently represent water delivery systems, some of which were extensive. The features described below include only those close to or integral with a power plant. Other features commonly associated with the rest of the system, away from the power plant, are described under the category of Infrastructure Components.

Driveshaft: In hydro plants, waterwheels were the motive source for the dynamos. A driveshaft was an intermediary mechanism that transferred motion from the waterwheels to dynamos. The waterwheels turned the shaft via gearing, and the shaft transferred the power to the dynamo via a canvas belt, drive-chain, or more gearing. The shaft was a solid steel rod at least 6' long, and rotated in bearings bolted to concrete or masonry pylons.

Driveshaft Foundation: Driveshafts rotated in heavy bearings that had to be firmly anchored to pylons of concrete or masonry. The pylons are typically at least 1'x1' in plan, feature anchor bolts on top, and are arranged in rows.

Nozzle: A nozzle squirted a high-pressure jet of water against the cups of a waterwheel to turn the device. Nozzles were of brass, bronze, or cast iron, and fastened to the end of a pressure pipe in a waterwheel foundation.

Nozzle Mount: A bracket or brace that held a nozzle steady in a waterwheel foundation.

Outflow Channel: An outflow channel conveyed spent water from a waterwheel out of a powerhouse. The channel passed from the waterwheel foundation, under the powerhouse floor, and downslope and away from the building. At powerplants with multiple waterwheels, several channels may have joined into a common ditch.

Penstock: A penstock was the pipeline that delivered water under pressure to the powerhouse. The pipeline began at a pressure box above the plant and descended so gravity could increase the force of the water falling within. Distinct diameter reductions further boosted the velocity of the water. When the penstock reached the slope base by the powerhouse, it became nearly horizontal and forked. Pressure pipelines continued into the powerhouse.

Penstock Bed: Penstocks were usually laid in depressed beds, which may have featured concrete footings to secure the pipe.

Penstock Remnant: A partially disassembled penstock and its bed.

Pipeline: A large-diameter pipe that carried water to or from the power plant.

Pipeline Bed: A raised or depressed bed for a pipeline, sometimes with concrete footings.

Pipeline Remnant: A partially disassembled pipeline and its bed.

Pressure Box: A wooden or concrete tank, upslope from a power plant, that directed water into a penstock for final pressurization. A ditch or pipeline delivered water to the pressure box from a stream or reservoir. The pressure box's elevation and the penstock's descent created enough force for the water to turn a waterwheel in the powerhouse.

Pressure Box Platform: Pressure boxes stood on earthen platforms below a ditch or reservoir. A penstock, or its bed, will descend from the platform, which may feature concrete, masonry, or timber footers.

Pressure Pipeline: A pressure pipeline was the final link between a penstock and the waterwheels inside the powerhouse. The pipeline carried water under great pressure beneath the powerhouse floor to the waterwheel channel, and ended with a nozzle. The pipeline was assembled with bolted steel segments, and had to be anchored to concrete pylons.

Valve: Penstocks and pipelines featured large valves at strategic points to redirect or stop water flows.

Valve Box: Valves were often enclosed in concrete, masonry, or plank boxes.

Waterwheel: Waterwheels converted the energy of pressurized water into mechanical motion for the dynamos. Waterwheels were of brass, bronze, or cast iron, 3' to 12' in diameter, and featured cups around the outside. A high-pressure jet against the cups spun the wheel, which rotated in heavy bearings within a waterwheel channel. The axle featured a gear that turned an adjacent driveshaft.

Waterwheel Channel: Waterwheels spun in narrow channels integral with a powerhouse foundation. The waterwheel and jet nozzle were bolted to a foundation that flanked the channel. An iron shroud covered the channel and prevented spray from soaking the powerhouse interior. In general, channels were between 1 and 3' in width, and 2' to 6' deep. An outflow carried spent water out the channel bottom.

Waterwheel Foundation: Waterwheels rotated in heavy iron bearings that had to be firmly anchored in place. The bearings were bolted to concrete or masonry blocks flanking a waterwheel channel. The blocks are symmetrical and feature two to four bolts each.

Steam Power Features

Boiler: A boiler was an iron vessel where extreme heat converted water into pressurized steam. Plumbing carried the steam from the boiler to an engine, which turned a power plant's dynamo. Electric companies relied on two types of boilers: return-tube and the water-tube units. The return-tube boiler, the most popular, consisted of a riveted plate-iron shell encased in a masonry setting. The shell was cylindrical, oriented horizontally, and featured numerous flue tubes. The most common size was approximately 5' in diameter and 16' long, and the masonry setting was 3' wider and 3' longer. The boiler's front almost always featured a cast-iron façade enshrouding a firebox underneath the shell. The façade featured a large upper door so workers could swab out the flue tubes, and lower doors to feed the fire and remove ash. When the boiler operated, the flue gases left the firebox, traveled through the setting and along the shell's bottom, rose into a smoke chamber in the setting's rear. In so doing, the gases heated the outside of the water-filled shell. The gases then returned through the flue-tubes perforating the shell, heating the water from within the shell.

Often, the boiler shell was salvaged when a power plant was retired, leaving only the masonry setting. For the researcher to record a feature as a return-tube boiler, it must possess the shell. If only the masonry is left, then it should be recorded as a *Boiler Setting Ruin* (described below).

Water-tube boilers were more efficient than return-tube units, providing the most steam for the least floor space and fuel. Water-tube boilers were also costly, complex, and required advanced engineering. In terms of design, the water-tube boiler was the antithesis of the return-tube unit. When the boiler operated, superheated gases traveled from the firebox around the tubes instead of through them, and exited via a smokestack. The tubes were filled with water, which volatilized into steam and rose into an overhead drum. The assemblage of tubes and drum stood on girders over a large brick setting, which featured iron hatches on the sides for cleaning and maintenance. A cast iron façade covered the tubes and firebox, and plumbing delivered fresh water, improved circulation, and permitted the unit to be drained.

Boiler Foundation: Boilers and their masonry settings were built on sound foundations that were flat. Most were slabs of concrete or brick masonry, although some outfits substituted rocks. Boiler foundations often feature iron braces, large-diameter pipes, and scattered bricks.

Boiler Setting Ruin: When boilers were dismantled, the hardware was usually extracted, leaving the masonry setting in a damaged state. Collapsed settings range in appearance from mostly intact masonry walls to piles of rubble. With some examination, the researcher may be able to discern enough of the walls to reconstruct the boiler type, size, and location of the firebox. Most setting remnants feature a bridge wall, which was a low brick divider in the setting's interior. The wall usually stood between the firebox and smoke chamber, and forced flue gases up against the boiler's belly. Most boiler settings consisted of common bricks on the exterior and fire bricks within.

Boiler Clinker Dump: When a boiler operated, intense heat fused impurities in the fuel coal into a scoriaceous, ashy residue termed clinker. Workers usually deposited the ash and clinker outside the powerhouse, forming a boiler clinker dump over time. Boiler clinker dumps also usually include slate fragments, unburned bituminous coal, and structural and industrial hardware.

Cistern: A concrete, masonry, or timber chamber that contained water for boilers or shop use. Because power plants usually relied on gravity to pressurize plumbing, cisterns tend to be located upslope.

Coal Bin: Coal bins contained fuel for a power plant's boiler. Most were of the sloped-floor variety and stood on a combination of cribbing and posts. Chutes projecting out of the front permitted a worker to unload coal and move it to the boiler.

Coal Bin Platform or Foundation: A platform or foundation that supported a coal bin. Sloped-floor bins usually stood on a platform and log or timber pilings. Coal fragments and dust are usually associated.

Coal Bin Ruin: The collapsed remnants of a coal bin.

Steam Engine: Prior to the 1920s, steam engines were a motive source for dynamo. Located on a power plant's central floor, the engine transferred motion to a driveshaft via a canvas belt, chain-drive, or gearing. The driveshaft was connected to the dynamo via more belts or gearing. Small power plants had horizontal engines between 2' and 4' in width and 8' to 20' long. The steam cylinder was at one end, a large flywheel was at the other end, and drive-rods connected the two. Large power plants relied on duplex engines with two steam cylinders flanking a central flywheel. A steam engine required a boiler.

Steam Engine Foundation: Steam engine foundations are often rectangular, studded with anchor bolts, and between 2' and 5' in width and 8' to 22' long. Workers built engine foundations with brick or rock masonry, or concrete, and the foundations often featured a pylon for the outboard flywheel bearing.

Water Main: Steam systems required dedicated water mains to provide the boiler with a constant supply of feed water. Mains ranged in size from 2" to 12" in diameter.

Water Tank: A large vessel, usually cylindrical, made of planks or sheet iron. To pressurize plumbing, water tanks were usually located above a power plant.

Water Tank Platform: Often a circular or semicircular platform for a tank. The platform's floor may feature a pipe.

Electrical Generation Features

Dynamo: A dynamo consisted of a wire-wound core in a cast-iron body, and it generated electricity when turning rapidly. Dynamos appeared similar to large motors, featured flywheels or gearing for motion, and were bolted to solid concrete or masonry foundations.

Dynamo Foundation: Foundations for dynamos were rectangular, 1'x2' to 6'x10' in area, and consisted of concrete or masonry. Four or six anchor bolts held the dynamo fast.

Switchpanel: A switchpanel featured switches, contacts, fuses, and indicators that completed a powerplant's electric circuitry. Switchpanels were slabs of marble, slate, porcelain, or artificial and infusible material, and usually stood upright on steel supports. Because of their function, switchpanels were convergence points for wiring and conduits.

Switchpanel Foundation: Switchpanels stood on steel legs bolted to timber or masonry footings. Clusters of small anchor bolts, and convergence points for wiring and conduits, often denote the location for a switchpanel.

Transformer Station: Within a powerhouse, a bank of transformers coordinated the electricity generated by the dynamos. Small banks were usually bolted to the powerhouse wall or support frame, and large banks were free-standing on independent frames. Electricity left the transformer station and went to a larger substation outside the powerhouse.

Transformer Station Foundation: Large banks of transformers often stood on concrete or timber footings. The foundation was rectangular, 1' to 3' wide, and 3' to 8' long.

Utility Pole: Powerplants featured numerous utility poles to carry electrical and telephone wires.

Powerhouse Features

Office: Electrical companies usually erected an office adjacent or attached to the powerhouse for administration. The building may have been professionally designed by an engineer or planned in the field by the construction crew, and assembled with standard materials. Because offices had no architectural style and were built for function and economy, they can be described as an industrial version of vernacular. In form, offices had gabled or hipped roofs, were rectangular or L in plan, and of frame construction. The interior tended to have no machinery or equipment, and the walls had large windows.

Office Foundation: The timber, concrete, or masonry footings that supported an office. The associated artifact assemblage tended to lack industrial and domestic refuse, and feature administrative and communication items.

Office Platform: An earthen platform on which an office stood. The associated artifact assemblage tended to lack industrial hardware and domestic refuse, and feature administrative and communication items.

Outhouse: Prior to the widespread adoption of flush toilets, powerhouse workers relied on outhouses for their personal use. Outhouses usually had gabled or shed roofs, were around 5'x6' in plan, featured a bench as a toilet seat, and stood over a pit.

Outhouse Pit: The pit that underlay an outhouse.

Pond: Some hydropower plants featured a pond immediately downslope to collect spent water.

Powerhouse: A powerhouse was the building that enclosed electrical generation equipment and its motive source. Most powerhouses were professionally designed by an engineer, and assembled with standard materials and factory-made hardware. When designing a powerhouse, the engineer adapted industrial architecture to the type, configuration, and size of the generating system. As a result, most if not all powerhouses were custom designs, unadorned and industrial in appearance. In size, the buildings were as small as single-family residences and as large as warehouses. In form, they ranged in plan from rectangular to complex with multiple extensions, and had gabled or cross-gabled roofs. In construction, most powerhouses were based on heavy frames, with plank, board-and-batten, or sheet-iron siding. The buildings stood on concrete or masonry foundations, often separate from the machinery mounts.

Powerhouse Foundation: Most powerhouse foundations consisted of concrete or masonry, outlined the building's footprint, and had interior piers supporting the floor. The foundation was often separate from the machinery mounts. Directly associated artifact assemblages typically include switchpanel fragments, numerous insulators, wires, and fuses.

Powerhouse Platform: Small powerhouses stood on impermanent foundations laid on earthen platforms. Workers usually graded such platforms with cut-and-fill methods and erected rock or cribbing walls to retain the cut- and fill-banks. Directly associated artifact assemblages typically include switchpanel fragments, numerous insulators, wires, and fuses.

Storehouse: An industrial building used primarily to store surplus materials and equipment. Storehouses ranged in size, had shed or gabled roofs, usually lacked windows, and featured broad doorways.

Storehouse Foundation: Large storehouses stood on well-built timber, concrete, or masonry foundations intended to bear great weight. Because storehouses were sites of little activity, they offer few artifacts.

Storehouse Platform: Small and light-duty storehouses stood on earthen platforms. Because storehouses were sites of little activity, they offer few artifacts.

Substation Feature Types

Distribution Line: Distribution lines carried adjusted current from substations to consumers. A single line could have featured numerous wires fastened to cross-members on a series of utility poles. Early wires were bare iron or copper, and later wires were sheathed with rubber or plastic.

Equipment Frame: Substations included electrical equipment in addition to transformers, such as circuit-breakers, grounds, junctions, rectifiers, and switchpanels. The equipment was usually bolted to steel or timber frames near transformers or utility poles.

Equipment Frame Foundation: Equipment frames were usually bolted to concrete or masonry pads or pylons near transformers or utility poles.

Fence: Fences often enclosed substations. Early fences consisted of planks or barbed wire, and by the 1950s, many were of chain link.

Storehouse: See Power plant Features above.

Storehouse Foundation: See Power plant Features above.

Storehouse Platform: See Power plant Features above.

Transformer Frame: Most substations had banks of transformers that were mounted to frames capable of bearing weight. At small substations, the frames were 3'x15' or less in plan, assembled from timbers, and rested on a foundation or spanned a gap between utility poles. At large substations, the frames were steel, supported several banks of transformers, and rested on a concrete foundation.

Transformer Frame Foundation: Transformers were bolted to frames were usually anchored to concrete or masonry pads or pylons with anchor bolts. The foundation may have been in a transformer house, or on an earthen platform.

Transformer House: Transformer houses were frame buildings that enclosed transformers, electric junctions, and other equipment. Inside, the transformers stood on a foundation while wiring and other equipment was fastened to the walls. Large transformer houses were professionally designed, small buildings were often planned in the field, and all were assembled with standard materials and factory-made hardware. When planning a transformer house, the builder had to consider interior equipment size and configuration, substation location, and integration with the rest of the electrical system. In form, transformer houses were square or rectangular, had gabled or shed roofs, and ranged in size from small sheds to cabins. They usually lacked windows, and wires entered through ports in the walls.

Transformer House Platform: Transformer houses usually stood on impermanent foundations laid over earthen platforms. Artifact assemblages feature high proportions of electrical hardware.

Transmission Line: A transmission line carried high voltage current from either a power plant or another substation through a provider's service area. A single line often featured several large-diameter wires fastened to chains of insulators on utility poles. Early wires were bare iron or copper, and later wires were aluminum.

Utility Pole: Utility poles are among the most common features in an electrical system. The poles carried transmission, distribution, and other lines, or supported electrical equipment. Some poles feature date nails stamped with the last two digits of the installation year.

Yard: The area around a substation was a yard kept free of vegetation, cleared of obstacles, and used for storage.

Infrastructure Feature Types

Water System Features

Water system features were components of a network that provided water to hydropower plants. Those system aspects away from the power plant are listed below, and those at the power plant are above.

Ditch: Ditches were inexpensive channels excavated into a slope, and they carried water for power generation. Ditches had to be carefully surveyed for necessary gradient, and they contoured from a diversion structure on a stream to a point upslope from the power plant. There, the ditch delivered water to a pressure box. Ditches often featured intermediary gates that drained water prior to servicing.

Diversion Dam: Those electrical companies that lacked reservoirs drew water from streams. A dam diverted some, but not all, the stream into a headgate, which captured the water for the power plant. Such dams were intended to slow the stream and create a pond, but not to completely impound the flow. Diversion dams ranged in height from 2' to 20', featured a collection ditch or headgate on one side, and had a spillway. The dams were made of gravel-filled log cribbing, rock masonry, or concrete.

Diversion Dam Ruin: The collapsed or eroded remnants of a diversion dam.

Diversion Structure: A diversion structure captured water from a stream or reservoir and directed it into a ditch or flume for the power plant. The structure featured a baffle in the stream channel that gathered water, and a headgate that admitted flow into the ditch, pipeline, or flume. A rock or concrete channel near the headgate minimized erosion, a screen prevented coarse material from passing into the flume or pipeline, and a catwalk allowed workers to access the headgate. The ditch and headgate were proportionate to the amount of water required by the power plant. Concrete or masonry prevented the baffle and ditch mouth from collapsing and eroding away. Impermanent structures were made of dry-laid rock walls and timbers.

Diversion Structure Ruin: The collapsed or eroded remnants of a diversion structure. After abandonment, even concrete and masonry structures crumbled and filled with gravel.

Flume: A flume served the same function as a ditch, and some ditches featured flume sections to carry water over and around obstructions. Most flumes consisted of plank walls and a floor nailed to the inside of box-frame sets, which were supported underneath by timber stringers. Flumes had to be carefully surveyed to maintain gradient, and they contoured from a diversion structure on a stream to a point upslope from the power plant. There, the flume delivered water to a pressure box. Flumes often featured intermediary gates that drained water prior to servicing.

Flume Bed: Flumes usually rested on a narrow bench cut out of a slope. When the flume was removed, lumber, nails, and the bench remained.

Flume Remnant: A collapsed flume.

Headgate: A headgate admitted water into the mouth of a ditch, flume, or pipeline. Small headgates featured plank walls and slots for a plank or steel gate. Large headgates had concrete or masonry walls and a steel gate raised with either a hand winch or worm gear. A catwalk over the gate provided access.

Headgate Remnant: The eroded or collapsed ruins of a headgate.

Pipeline: A pipeline served the same function as a ditch, and some ditches featured pipeline sections to carry water over and around obstructions. Most pipelines were riveted or spiral-welded steel tubes supported underneath by timber footers. They contoured from a diversion structure on a stream to a point upslope from the power plant. There, the pipeline delivered water to a pressure box. Pipelines often featured intermediary gate valves that drained water prior to servicing.

Pipeline Bed: Pipelines usually rested on timber footers laid on a narrow bench cut out of a slope. When the pipe was removed, the footers and bench remained.

Pipeline Remnant: A partially disassembled pipeline.

Pressure Box: See Power plant Features.

Pressure Box Platform: See Power plant Features.

Pressure Box Ruin: See Power plant Features.

System Maintenance Features

Electrical systems required regular maintenance, repairs to components, and the storage of materials. Facilities that carried out these functions can be found at a power plant, central yard, or individually.

Loading Dock/Platform: Maintenance yards and storehouses often featured loading docks and platforms to transfer heavy appliances and materials off trucks or railroad cars. The docks were frame structures with piling foundations and plank decking. Some were of concrete.

Maintenance Yard: Power companies responsible for extensive grids designated yards for their service facilities. Often fenced, most yards included a shop, storehouse, loading dock, and an open area for poles, cable spools, and large appliances such as transformers.

Office: Electrical companies usually erected an office adjacent to maintenance facilities to house administration. See Power plant Feature Types.

Office Foundation: See Power plant Feature Types.

Office Platform: See Power plant Feature Types.

Outhouse: See Power plant Feature Types.

Outhouse Pit: The pit that underlay an outhouse.

Shop: Electric companies repaired and serviced hardware and equipment in shop buildings. Nearly all had capabilities for blacksmithing, machining, and carpentry. Blacksmith work areas featured a forge, an anvil, hand tools, a workbench, and a bin for anthracite coal. Adjoining were machining appliances such as a lathe, drill-press, pipe cutter, power hammer, and welder. The carpentry station had a drill press, lathe, power saw, planer, and other equipment. Electric motors powered the equipment via a system of driveshafts and canvas belts. Large shops were professionally designed, small buildings were often planned in the field, and all were assembled with standard materials and factory-made hardware. When planning a shop, the builder had to consider interior equipment size and configuration, and cost. In form, shops were square or rectangular, had gabled roofs, and ranged in size from small cabins to warehouses.

Shop Foundation: The shop building and the power appliances within were anchored to concrete or timber foundations on an earthen platform. The building foundation reflected the structure's footprint, and the appliance foundations were specific to individual machines. The artifact assemblage includes shop and blacksmithing refuse.

Shop Platform: Small, light-duty shops stood on impermanent foundations of timbers on an earthen platform. When dismantled, the facility left primarily the platform and an artifact assemblage heavy with shop refuse.

Shop Ruin: The collapsed remnants of a shop.

Shop Refuse Dump: Shop work generated refuse in the form of forge-cut iron scraps, metal turnings, wood scraps, and machine parts. Employees threw these materials downslope from the building, forming concentrated dumps. The size of the dump reflected the intensity and duration of shop work.

Shop Refuse Scatter: A scatter of shop refuse, usually around the shop building.

Storehouse: See Power plant Features.

Storehouse Foundation: See Power plant Features.

Storehouse Platform: See Power plant Features.

Utility Pole: Maintenance facilities naturally relied on electricity for lighting and power. Utility poles supported the wires, light fixtures, a transformer, and switchpanel.

Reservoir Feature Types

Catwalk: Catwalks were narrow piers, walkways, or scaffolds that allowed workers to access reservoir structures and valve wheels. Most catwalks had plank decking over timber stringers, supported by timber or log piers.

Dam: Dams impounded water for long-term storage and eventual diversion into a hydro-plant's water system. Most dams blocked minor drainages or the mouths of natural lakes. Low dams consisted of concrete, masonry, or earth retained by log cribbing and boulders. High dams were almost exclusively of concrete. One side featured a spillway, and the center had a drain that directed water into a pipeline. A wheel above the drain engaged the valve that admitted water.

Dam Ruin: The breached and eroded remnants of a dam.

Ditch: Ditches were surface excavations that carried water into a reservoir, or sent diverted water away to a power plant. Ditches contoured across slopes and required exacting surveying to maintain gradient.

Diversion Structure: The base of a dam had a structure that controlled reservoir outflow, captured some of the current, screened coarse debris, and shunted the water into a ditch, flume, or pipeline. Diversion structures on large dams were usually chambers of concrete or masonry, or of planks on small dams. Water came from the dam's drain either through a pipe or outflow channel.

Inlet: Well-built reservoirs featured a structure that regulated and measured the input of water. Concrete and timber cribbing slowed the flow, decreased erosion, and had a gauge for measuring volume.

Level Gauge: The volume of water in a reservoir was measured by numbers painted on the face of a dam or vertical structure. The numbers represented common units of measure such as miner's inches, acre-feet, or gallons.

Outflow Channel: A drain, built into the dam base, siphoned water from the reservoir bottom and directed it into an outflow channel. The structure then carried the water under the dam to a diversion structure. The drain may have been a large-diameter pipe or a box culvert made of concrete or planks.

Pier: Large reservoirs had piers extending outward from the dam and over the drain pipe so a worker could manipulate the valve wheel. Some reservoirs also had piers for skiffs. The structures consisted of log pilings and plank decks.

Spillway: Nearly all dams had spillways to control the release of overflow water and prevent the erosion it otherwise caused. The spillway was usually on one end of the dam. Large dams featured concrete or masonry spillways, while those on small dams were of dry-laid rock or timber cribbing. The spillway directed the water into a drainage below the dam.

Valve: Valves controlled the amount of water exiting the reservoir's main drain and occasionally an emergency drain. On small dams, the valves were exposed gates in steel tracks, and raised by hand winches. On large dams, they were integral with the drain pipe and were raised via a gear turned by wheel.

Valve House: Large dams had valve houses, which were sheds that enclosed the valve mechanism. The sheds were small, impermanent, and planned in the field.

Valve Mechanism: Most valves were of the gate type, and a mechanism raised and lowered the heavy steel gates. The mechanism for an exposed gate was a hand winch anchored to a concrete or masonry foundation. The mechanism for a gate in a main drain was a worm gear turned by a wheel. The gear and wheel rotated in bearings bolted to steel or timber brackets.

Section B 5: Railroad Property Types and Registration Requirements

Each drainage in the I-70 corridor features historic resources from the railroad era. Abandoned grades, whole or segmented, are the most common, while some tunnels, bridges, and culverts exist. Each railroad company also built right-of-way structures and service facilities in support of ongoing operations. Many have been dismantled, leaving resources on an archaeological level. Resource of this nature could be eligible for the NRHP when material evidence clearly conveys a Property Type, timeframe, and significance.

Two railroads still operate in the corridor. The Burlington Northern Santa Fe runs regional and transcontinental trains over a modified historic grade along the Colorado River in the corridor's western portion. The grade ascends the river from Glenwood Springs east to Dotsero and branches. One branch continues east along the Eagle River to Minturn, veering southeast and leaving the corridor on its way to Leadville. The afore-mentioned line is the Leadville to Glenwood grade built in 1887 by the Denver & Rio Grande. The other branch follows the Colorado River from Dotsero north out of the corridor, and is the Dotsero Cutoff completed by the Denver & Rio Grande Western in 1934. Presently, the Dotsero Cutoff and line to Glenwood Springs are active, while the branch to Leadville is intact but abandoned. History Colorado owns the second railroad, a tourist steam operation on the Georgetown Loop in Clear Creek County, with recent bridge replacing the original. All have been impacted within the last fifty years through replacement of materials, equipment, and structures. Eligibility might not, however, be precluded. The resources in entirety, or segments therein, could be eligible if present character-defining attributes date to a Period of Significance and sufficiently convey resource significance. Resources heavily modified within the last fifty years may qualify for nomination under a later Period of Significance as time passes and this context is updated. They can also be evaluated under NRHP Criterion Consideration G, recognizing exceptionally important properties that achieved significance within the last fifty years.

In 1997, Clayton Fraser produced the Colorado statewide railroad context *Railroads in Colorado, 1858-1949: Multiple Property Submission*.⁶⁹⁸ The context discusses common railroad resources, their relevant Areas of Significance, and registration requirements. Although the context is statewide, the information directly applies to resources in the corridor because its railroads largely followed statewide patterns. Thus, for brevity, universal Property Types are noted below but refer the reader to Fraser's document for full text.

In some cases, railroad rights-of-way may include clusters of related Property Types in addition to a railroad grade itself. A depot featuring associated right-of-way structures and objects, including signs, is one example. Cohesive assemblages of resources may qualify as historic districts when contributing elements and integrity sufficiently convey the Property Types and their significance. To describe and evaluate contributing grade segments, tunnels, bridges, and trestles and viaducts, consult Appendix VI in National Register Bulletin 16A: *How to Complete the National Register Registration Form*, available at History Colorado and the National Park Service.⁶⁹⁹ Also, consult *Railroads in Colorado, 1858-1949* for context.

⁶⁹⁸ Fraser, Clayton *Railroads in Colorado, 1858-1949: Multiple Property Submission* Denver, CO, 1997, Colorado State Historic Preservation Office, Colorado Historical Society.

⁶⁹⁹ *National Register Bulletin 16A: How to Complete the National Register Registration Form*. National Park Service, 1997 [1977].

The following property types are developed in this section:

- Railroad Tracks and Roadbed
- Miscellaneous Right-of-Way Structures
- Depot
 - Combination Depot
 - Flag Depot
 - Passenger Depot
 - Temporary Depot
- Housing and Maintenance Structures
- Drainage and Separation Structures
 - Culvert
 - Bridge

PROPERTY TYPE: RAILROAD TRACKS AND ROADBED

See *Railroads in Colorado, 1858-1949*. See Illustration B 5.1 for an example.

PROPERTY TYPE: MISCELLANEOUS RIGHT-OF-WAY STRUCTURES

See *Railroads in Colorado, 1858-1949*. See Illustration B 5.2 for an example.

PROPERTY TYPE: DEPOT

Depots, covered in detail in Fraser's Colorado railroad context, are among the prominent icons of the railroad industry. The depot was a crown jewel for every mountain community served by a railroad because it symbolized rail service, local economic success, and corporate presence, strong values of the time. Depots were also focal points for movement of people and freight, and communication in the forms of newspapers, mail, telegraphs, and telephones. Railroad companies assigned great importance to depots for a number of reasons. Ticket and freight offices were principal places of business where revenues were collected. Administrative offices were centers of regional operations, coordination among trains, maintenance, and railroad communications. Some depots even offered housing for regional railroad employees. Fraser identified five general types of depots common in Colorado, including combination, flag, passenger, temporary, and terminal depots. All categories except for terminal depots either were likely or known to have existed at one time in the I-70 corridor. Further research is necessary to determine where each type was located, although historic photographs indicate that Idaho Springs had a combination depot (Illustration B 5.3), Frisco a flag depot (Illustration B 5.4), and Graymont a temporary depot (Illustration B 5.5). Terminal depots were large edifices usually serving important railroad terminals in cities such as Denver.

Depot Property Subtypes

Property Subtype: Combination Depot: See *Railroads in Colorado, 1858-1949*.

Property Subtype: Flag Depot: See *Railroads in Colorado, 1858-1949*.

Property Subtype: Passenger Depot: See *Railroads in Colorado, 1858-1949*.

Property Subtype: Temporary Depot: See *Railroads in Colorado, 1858-1949*.

PROPERTY TYPE: HOUSING AND MAINTENANCE FACILITIES

Mountain railroading came with many challenges. Keeping the system and its equipment in running order was a perpetual and costly process because conditions and climate caused heavy wear. Hardware, structural elements, tools, machinery, and rolling stock required regular maintenance if not replacement. Railroad companies completed most of this work at centralized yards located outside of the I-70 corridor. But they also had satellite facilities at strategic points within the corridor, occasionally on spurs and sidings, and primarily in centers of operation such as Georgetown, Frisco, Minturn, and Dotsero (see Illustration B 5.6). The yards also were used for freight transfer and storage, and sometimes workers' housing.

Service facilities in the mountains often included open work stations, structures, buildings, and mechanical systems usually clustered together at a small yard, a rail siding, or spur. Most were dedicated to maintenance operations, although yards were also used for storage and transfer of custom freight and railroad materials. A typical yard on a mountain railroad may have included one or two shops for machining and carpentry, and an open-air work station where large pieces of equipment were serviced. Workers stored lubricants, solvents, and other goods in a small oil house, and tools and handcars for track maintenance in a tool shed. Locomotives received coal and traction sand from bins along a spur track or siding, where train crews also stationed snowplows and empty cars. Multi-use yards sometimes had loading docks, storage sheds, and hoisting derricks for freight. For descriptions of and context for specific housing and maintenance facilities, see *Railroads in Colorado, 1858-1949*.

PROPERTY TYPE: DRAINAGE AND SEPARATION STRUCTURES

All the railroads in the I-70 corridor grappled with numerous topographic obstacles interfering with the direct, consistent grade required for locomotives and their trains of cars. The railroad companies constructed drainage structures and tunnels to overcome the impediments. Drainage structures allowed grades to pass over ditches, streams, rivers, and other low points. Bridges literally carried tracks over streams or rivers, while culverts directed runoff underneath the railroad bed. Tunnels were bores blasted through obstructions, such as bedrock outcrops, for

train passage. All were critical to the success of railroading in the corridor. For descriptions of and context for drainage and separation structures, see *Railroads in Colorado, 1858-1949*.

Drainage Structure Subtypes

Property Subtype: Culvert: See *Railroads in Colorado, 1858-1949*.

Property Subtype: Bridge: See *Railroads in Colorado, 1858-1949*.

Property Subtype: Tunnel: See *Railroads in Colorado, 1858-1949*.

RAILROAD PROPERTY TYPE SIGNIFICANCE

The railroad grades, right-of-way structures, depots, housing and maintenance structures, and drainage and separation structures were important components of railroad systems. Every railroad in the corridor included most of these Property Types, as no system could have functioned without them. Given this, the Property Types share the same general registration requirements and NRHP Areas of Significance. The Areas are: Architecture, Commerce, Community Planning and Development, Economics, Engineering, Industry, and Transportation. In general, the Period of Significance 1873 to 1962 covers railroad transportation as a theme throughout the corridor, but narrower timeframes may be regionally applicable. The Periods of Significance are: 1873 to 1940 in Clear Creek drainage; 1881 through 1937 in Summit County; and 1886 to 1962 along the Eagle and Colorado rivers. Level of significance will be local, and possibly statewide or national, depending on further research.

Area of Significance: Architecture: Depots were significant in the Area of *Architecture* as prominent icons of railroads, a highly valued and important institution. According to *Railroads in Colorado, 1858-1949*, depots were among the most architecturally accomplished buildings in a community, and may have been a railroad's only individually designed building, others having been prefabricated or constructed from standardized plans. Railroad companies often intended depots to be a visually prominent aspect of a community and, as the primary point of public contact, convey a corporate identity.⁷⁰⁰ Maintenance buildings were significant for providing support critical to on-going railroad operations. Many were designed to withstand heavy industrial use and wear within difficult environmental conditions, while costing little to construct. To meet changing needs in function and location, maintenance buildings tended to be simple, industrial in appearance, and periodically repaired, modified, or moved.

Area of Significance: Commerce: Railroads were significant in the Area of *Commerce* because they facilitated trade of high volumes of goods between regions within and outside of the corridor. Differing regions were able to ship finished products to market, import needed goods, and develop service industries based on tourism. The railroads made these trends possible on a large scale, over great distances, and during lengthy periods of time.

⁷⁰⁰ Fraser, 1997:161.

Area of Significance: Community Planning and Development: Railroads influenced settlement patterns in extant corridor communities and were the reason for the establishment of others. In particular, Graymont in Clear Creek County and Minturn in Eagle County were established by railroad companies. When railroads arrived in the corridor's extant communities, such as Idaho Springs, Georgetown, and Dillon, they changed patterns of community growth. As the communities grew, industrial facilities, transportation nodes, and residential development gravitated to railroad rights-of-way.

Area of Significance: Economics: In the Area of *Economics*, railroads were significant for several reasons. First, the railroads radically changed the economies of their service areas through low-cost freight transportation. The price of goods and industrial supplies fell, while the worth of available natural resources increased. Industry grew as a result, providing communities more money with increased purchasing power. Businesses and residents were able to buy higher volumes of goods at lower prices than before, improving daily life and conditions for industry.

Second, the railroads brought new money into communities by facilitating investment in their service areas. Railroads fostered confidence among business financiers, who were more likely to visit in the comfort of a railroad and provide capital for ventures made tangible through personal examination.

Third, railroads were the prime carrier of physical monies between regions. The money went to banks, businesses, and local government. Further, railroads shipped gold and silver bullion produced in mining districts to financial institutions in Colorado's banking centers. This movement of wealth was a cornerstone of Colorado's economy.

Area of Significance: Engineering: As components of larger mountain railroad systems, the corridor's lines are significant in the Area of *Engineering* for several contributions. The Rocky Mountains presented topographic and climatic challenges few companies had previously faced. Company engineers had to adapt conventional design principles when planning routes through tight mountain canyons, up steep grades, and across bedrock slopes. In some cases, engineers overcame restrictive topography with innovative engineering solutions. The Georgetown Loop and the Argentine Central, for example, were precedent-setting in their own ways. The Georgetown Loop featured a continuous loop with steel trestle crossing, and the Argentine Central was the highest in North America at the time. The mountain conditions presented challenges to ongoing operations once the railroad companies finished their lines. Train crews developed infrastructure systems and strategies, such as shortening trains, for climbing and descending exceedingly long grades, and used rotary snowplows to keep tracks snow-free. The carriers also improved traffic control communications and signal systems to prevent conflict. The mountain conditions presented business opportunities that stimulated engineering. In Clear Creek drainage, the Colorado Central Railroad (CCRR) integrated pavilions, services, and destinations into its system to enhance a growing tourist trade. The Denver & Rio Grande Western (D&RGW) invented observation cars to lure tourists onto its Colorado River line and used them as a basis for the California Zephyr train. Overall, these and other improvements became contributions to railroading as engineers adapted them to other systems elsewhere.

Area of Significance: Industry: The corridor's railroads contributed in the Area of *Industry* by providing their service areas with the first, inexpensive, all-season transportation capable of hauling weight and volume. In so doing, the railroads fostered the growth of associated industry,

primarily mining, logging, and dependent businesses. Operating costs fell, large machinery and other technologies could be hauled in at affordable prices, and rates for shipping ore and forest products to market decreased substantially. These trends are readily apparent in corridor history. The CCRR helped bring Clear Creek drainage into boom shortly after establishing its Floyd Hill railhead in 1873. The Denver & Rio Grande (D&RG) and Denver, South Park & Pacific (DSP&P) had the same effect in Summit County beginning in 1882. The D&RG Leadville to Glenwood Springs line boosted mining at Aspen beginning in 1887, and coal production in the Colorado River valley in the next decade. The line also supported steel smelting in Utah and Pueblo, Colorado. All the railroad lines fostered other industries throughout the corridor, such as farming, ranching, and tourism.

The railroads were important as large industries in themselves. The railroads employed hundreds, contracted with numerous service businesses, produced thousands of ties, and supported economies throughout the corridor.

Area of Significance: Transportation: In the Area of *Transportation*, railroads were the corridor's principal carriers of people, freight, and money. By carrying freight and money, the railroads supported industry and settlement. Natural resources and other industrial products flowed out of the corridor, and supplies and domestic goods for industry and residence flowed in. By carrying people, the railroads supported settlement, tourism, and the migratory pattern characteristic of the mountain west.

Depending on the outcome of further research, the D&RG Leadville to Glenwood Springs and Dotsero Cutoff lines may be significant on a national level as the only transcontinental routes through the central Rocky Mountains. The lines tied portions of the nation east of the mountains to portions in the west. From around 1900 to present, the lines carried all manner of freight and passenger traffic between the western and eastern states. This was important in the broad movement of natural resources, manufactured goods, food, mail, the military, professionals, tourists, and people in residential transition.

Railroad Property Type Registration Requirements

To qualify for the NRHP, railroad resources must meet at least one of the Criteria listed below and possess adequate physical integrity to convey Property Type and significance.

Criterion A: Resources eligible under Criterion A must be associated with at least one Area of Significance noted above as well as contribution to a broad pattern of history.

Criterion B: Railroads may be eligible under Criterion B provided an association with the life of an important person significant in our past. Presence will probably be through employment, operations management, or construction. The resource must date to the same timeframe when the individual achieved significance, and retain physical integrity relative to the person's productive life. A brief biography is necessary to explain the individual's significant contributions. Important people invested in railroad companies or owned property, but did not personally occupy a site. Such an association does not meet the registration requirements outlined here. The individual of note must have been present on-site in a meaningful capacity.

Railroad grades have high potential for eligibility under Criterion B because most were personally surveyed and built by noteworthy engineers and construction contractors. Some

tunnels, bridges, right-of-way features, and service facilities might qualify, as well. Combination, passenger, and freight depots may qualify if workplaces of important individuals. In general, applying Criterion B is complex, and *National Register Bulletin 32: Guidelines for Evaluating and Documenting Properties Associated with Significant Persons* can provide further guidance.

Criterion C: Railroad Property Types may be eligible under Criterion C when they clearly convey their timeframe, function, design, and relationship to the overall railroad. The Property Types must possess sufficient integrity to convey their significance. A resource retains integrity on an archaeological level when material evidence clearly conveys function, overall design, structures and equipment, operations, and Period of Significance. Intact buildings, structures, and machinery are rare and important, and may qualify individually as examples of Engineering and Architecture specific to mountain railroads.

Eligible *railroad grades* must possess a predominance of original aspects including surveyed route, bed surface, cuts and fills, and other adaptations to topography. Most of the corridor's railroad grades evolved since abandonment, and changes should be carefully identified and assessed. A grade may have been widened, curves straightened, cut-banks relaxed, and tracks rebuilt from narrow- to standard-gauge. Grades, whole or segmented, might represent adaptation of railroad design, planning, and construction methods to a challenging mountain environment. Small-scale features can be important contributing elements if they convey aspects of railroad engineering. Examples include track, switches, and adaptation to natural features.

Eligible *tunnels, bridges, and culverts* convey design, engineering, construction methods, and relationship with the railroad. Tunnels must possess intact portals with original appearance and minimal alteration. Bridges should retain form, materials, and features of their superstructures and substructures. If a bridge has been dismantled, its remaining archaeological or engineering features can be eligible when they clearly convey specifics of the super- and substructure. Bridges and tunnels may be also eligible as representative works of master engineers or contractors.

Right-of-way structures and objects may be eligible when they reflect their resource type and convey its significance. Small-scale features such as signs and switching devices must be relatively complete and in place. Engineered systems, such as track signals and water tanks, should reflect design, construction, and integration into the railroad. When represented by archaeological evidence, systems or their components can be eligible if remnants convey the above characteristics

Maintenance facilities should represent the design, function, timeframe, and composition of their resource types. Buildings, engineered structures, and designed complexes such as yards need not be complete to be eligible. Resources can be eligible if well represented by archaeological features and artifacts. Material evidence must convey design, function, timeframe, and relationship to the railroad.

Depots may be eligible when they reflect one of the types and date to the parent railroad's operating timeframe. Preserved depots may reflect architectural styles, floor plans, and construction methods common to the railroad industry. They also could represent how railroad companies organized and facilitated a flow of passengers and freight through stations. If a depot has been dismantled, its remaining archaeological features can be eligible for the same reasons, provided that they clearly convey design, use, and timeframe.

Property Types may also be eligible if they are contributing elements of historic landscapes. When in an urban setting, nearby buildings and structures should be compatible in

age, with the property type contributing to the community's historic feeling. When in a rural setting, the Property Type, or its archaeological remnants, should contribute to the feeling of railroads as the principal transportation in the mountains. If the resource is in an industrial setting, then it should convey the relationship between railroads, manufacturing, or natural resource extraction. Nearby historic resources must be compatible in timeframe and possess integrity.

Criterion D: Railroad Property Types may be eligible under Criterion D if they will yield important information upon further study. In general, the researcher must state the arena of inquiry, why it is important, and how the resource will address the questions. If a resource possesses structures and buildings, detailed examination may reveal how engineers adapted architectural, structural, and mechanical design to run and maintain railroads in difficult, high-altitude conditions. Intensive inventories and analyses of artifact assemblages around service facilities and depots may enhance existing knowledge regarding railroad operations, maintenance, and behaviors of workers and travelers.

Eligible Property Types must possess physical integrity relative to the timeframe when their parent railroad operated. In some cases, railroad system components were dismantled when retired, leaving archaeological evidence. Integrity on an archaeological level is sufficient when material evidence clearly represents the facility, its operation, timeframe, and significance. In other instances, railroad companies replaced aging equipment, structures, and buildings, impacting integrity. A resource may be eligible if present character-defining attributes convey its significance. Common Property Type features and character-defining attributes are at the section's end.

Most of the seven aspects of integrity defined by the NRHP apply to railroad property types, although not all need be present. Intact buildings, structures, and machinery must be in their places of functional use to retain integrity of *location*. For a resource to retain integrity of *design*, material remains, including archaeological features, must convey the facility's organization, planning, engineering, and integration with the railroad. To retain integrity of materials, the physical substance used in buildings, structures, and machinery should date to a railroad's timeframe. To retain *setting*, the area surrounding the resource must not have changed a great degree from operational timeframe. If the resource is isolated, then the natural landscape should be preserved. If the resource lies in a mining or logging landscape, then the surrounding resources should retain integrity at least on an archaeological level. If the site lies in an urban setting, then adjacent buildings and structures should be compatible in age. In terms of *feeling*, the resource should foster a perception of its function and relationship to the railroad from a historical perspective, and from today's standpoint. Integrity of *association* exists where buildings, structures, machinery, or archaeological features convey a connection between the resource and a contemporary observer's ability to discern its historic function.

PROPERTY TYPE: RURAL HISTORIC RAILROAD LANDSCAPE

Rural historic landscapes are large-scale cultural resources revealing the history of an area's human occupation, life ways, and relationship with the land. In the I-70 corridor, rural historic landscapes provide broader physical context for resources left by railroads. The extensive tracts of land traversed by railroads, combined with natural features and smaller scale historic resources, represent the history, people, traditions of railroading, and their relationship with the rest of the region.

The National Park Service defines eleven characteristics of rural historic landscapes. The first four are a result of processes instrumental in shaping the land, and the last seven are physical attributes apparent on the land.⁷⁰¹ All are tangible evidence of the activities, values, and beliefs of the people who occupied, developed, used, and shaped the land to serve human needs. The categories include: land uses and activities; patterns of spatial organization; response to the natural environment; cultural traditions; circulation networks; boundary demarcations; vegetation related to land use; buildings, structures, and objects; clusters; archaeological sites; and small-scale elements.

The defining characteristics of a rural historic railroad landscape also can be described in terms of "landscape of work."⁷⁰² When railroad companies graded lines through the natural environment, they molded the landscape for efficiency, organization, and technology of trains. Landscapes of work for railroad transportation feature defining characteristics and patterns. The most common broad-scale pattern was a route along paths of least resistance while linking key communities and centers of industry. The railroad companies sited stations, freight yards, and service facilities in communities and industrial areas. Within each complex, buildings and facilities were often clustered for efficiency in materials-handling, loading, movement of people, and ongoing operations. Circulation systems in the form of roads linked the stations and freight yards with centers of industry and population.

Although most railroad landscapes of work are no longer used for their original purpose, they offer evidence of associated cultural traditions. Railroading had tangible impacts on the I-70 corridor by facilitating vegetation change, contributing to the development of road networks, and influencing spatial patterns of settlement and industrial development. Railroad resources and aspects of the natural environment are interspersed and should be considered together as a whole.

Rural Historic Railroad Landscape Significance

Because railroad landscapes are large in scale, their significance as cultural resources can be assessed in a broad sense. The most relevant NRHP Areas of Significance include Architecture, Commerce, Community Planning and Development, Economics, Engineering, Industry, and Transportation. Because railroad landscapes are diverse, complex, and exhibit numerous historic resources, most will be significant under multiple NRHP Areas and criteria.

The Period of Significance 1873 to 1962 encompasses railroading throughout the I-70 corridor, but narrower timeframes may be applicable to specific regions: 1873 to 1940 in Clear Creek drainage; 1882 to 1937 in Summit County; and 1886 to 1962 along the Eagle and Colorado rivers.

⁷⁰¹ McClelland, et al., 1999:3.

⁷⁰² Messick, Denise P.; Joseph, J.W.; Adams, Natalie P. *Tilling the Earth: Georgia's Historic Agricultural Heritage, A Context* Stone Mountain, GA, New South Associates, 2001:62.

Area of Significance: Architecture: Those historic landscapes with standing buildings may be important in the Area of *Architecture*. Railroad engineers and contractors adapted previously established building forms, designs, and methods of construction to Rocky Mountain rail systems. In their adaptation, builders considered natural landscape features, local climate, available materials, cost, and integration with the railroad. Multiple buildings distributed in a landscape can represent the evolution of architecture specific to railroads.

Area of Significance: Commerce: Railroads facilitated the movement of raw materials, finished goods, and people through the corridor, and to trade and transfer points within. The commerce directly supported communities, rural development, industry, and regional economies. The railroads also made broad commercial systems possible by connecting various regions in Colorado. The commerce supported by the railroads was expressed in the landscape through settlement, development, and natural resource extraction.

Area of Significance: Community Planning and Development: Railroad landscapes may be important in the Area of *Community Planning and Development*. They reflect the direct influence that rail service had on settlement, industry, and related land use patterns. The development of rail lines, trends in industrial growth and decline, and the effect on communities are often evident in the landscape.

Area of Significance: Economics: Railroads were conduits for a flow of wealth through the corridor. Carriers shipped huge amounts of natural resources and products to market, where they were exchanged for cash and finished goods. The money and goods were then hauled into the corridor and distributed among residents and industry, with wealth changing hands in each transaction. The railroads also brought new monies into the corridor in the form of capital investment. Financiers accustomed to comfort were more likely to invest in the corridor when they could travel by rail. Personal examination of an industry or area often increased confidence among financiers, who were then more willing to invest. Money and investment manifest in the landscape as settlement, development, and industry. The railroads themselves were economically important, funding infrastructure and operations and distributing income along their routes. The infrastructure became a direct expression of wealth in the landscape.

Area of Significance: Engineering: Railroad landscapes may convey implementation of period transportation engineering in the central Rocky Mountains. Representation may be through small-scale resources, in turn reflecting adaptation of railroad equipment and structure design, form, and construction to the mountain environment. Large-scale systems, especially grades, can convey how railroad engineering principals were molded to the unique topographical conditions of the mountains. The railroad companies also may have innovated new ways of solving problems posed by the land and its resources, exemplified by the Georgetown Loop. Multiple structures arranged in a landscape can represent the evolution of engineering and construction specific to railroads.

Area of Significance: Industry: Railroads impacted growth of industry in the corridor by reducing transportation costs, increasing availability of industrial supplies, hauling in large pieces of machinery, and carrying natural resources and other products to market. Industry

boomed, expanded, exhausted available natural resources, and then contracted or disappeared altogether. These patterns are expressed in the evolution of land use. The railroads were an important industry in themselves, using the land in their own way and creating systems landscape in scale.

Area of Significance: Transportation: Railroads were significant transportation systems, underwriting how corridor's landscapes were shaped. In moving materials and people in volume, they influenced patterns of industrial and community development, and other forms of land use such as agriculture and tourism. Railroad landscapes are expressions of this important form of period transportation and its impacts on the natural environment.

Rural Historic Railroad Landscape Registration Requirements

To qualify for the NRHP, railroad landscapes must meet at least one of the Criteria listed below, and possess adequate physical integrity to convey their significance.

Criterion A: Resources eligible under Criterion A must be associated with at least one Area of Significance noted above as well as a contribution to a broad pattern of history.

Criterion B: Large-scale and small-scale landscapes may be eligible under Criterion B through association with the life of an important person significant in our past. Presence will most likely be through employment, railroad development, or other involvement with a railroad. The landscape must retain physical integrity relative to that person's occupation during their productive life. A brief biography is necessary to detail the individual's significant contributions. In some cases, important people invested in railroads or were train passengers but did not occupy the property. Such an association does not meet the registration requirements outlined here. The individual of note must have been present on the ground. In general, applying Criterion B is complex, and *National Register Bulletin 32: Guidelines for Evaluating and Documenting Properties Associated with Significant Persons* can provide further guidance.

Criterion C: Historic landscapes may be eligible under Criterion C if buildings, structures, and landscape features represent a railroad and its relationship with associated industry and communities. Because landscapes were occupied for extended periods of time, the patterns can reflect the evolution of land use during the Period of Significance. Intact buildings may be significant representations of architecture specific to railroads in the central mountains. Multiple buildings within a single landscape may represent evolution in type, style, methods, workmanship, and materials. Similarly, structures may be significant representations of engineering specific to railroads, and multiple structures within a single landscape may represent evolution of function, design, methods, workmanship, and materials. Buildings and structures may also exemplify characteristics distinct to the corridor. Natural features are contributing elements.

Criterion D: Buildings, structures, and land modifications often left archaeological evidence when removed or abandoned. When this evidence clearly represents land use patterns, then the landscape retains integrity on an archaeological level. For archaeological remains to retain integrity, the material evidence should represent the general layout of individual complexes, as

well as their relationships to industry, communities, and the land. If archaeological features and artifacts offer important information regarding land use, community development, engineering, or railroad operations, then the landscape may qualify under Criterion D.

If complexes within the landscape possess building platforms, privy pits, and refuse dumps, testing and excavation of these buried archaeological deposits may reveal important information regarding lifestyle and demography of the occupants. When the results from multiple complexes are compared, regional patterns may become apparent. Important areas of inquiry include but are not limited to diet, health, and distribution of gender, families, ethnicities, professional occupation, and socioeconomic status.

Historic landscapes eligible for the NRHP must possess physical integrity relative to their Period of Significance. According to the rural historic landscape National Register Bulletin: “Integrity requires that the various characteristics that shaped the land during the historic Period be present today in much the same way they were historically.”⁷⁰³ Continued occupation and use, however, changed railroad landscapes in the corridor to some degree. Occupation and use are compatible with integrity when they maintain the character and feeling of railroads and their relationship with the land. Forestry, logging, underground mining, and ongoing railroad operations are compatible, while modern intrusions should be few and unobtrusive. The presence of some landscape characteristics is more important to integrity than others. Railroad grades, historic industrial sites, natural features, and the types of small-scale features typical of railroads should be present.

Many of the seven aspects of historic integrity defined by the NRHP apply to railroad landscapes, although not all need be present. *Location* is the place where significant activities that shaped land took place. A landscape whose characteristics retain their historic place has integrity of location. For integrity of *design*, the landscape features, both manmade and natural, must convey aspects of railroad organization and planning. *Setting* is the physical environment within and surrounding a historic property. To retain integrity of setting, a landscape and bordering area must not have changed a great degree in overall character. Because corridor railroads traversed the natural environment, preserved forests, streams, and mountainsides should be present. For integrity of *feeling*, the landscape should convey railroad systems from a historical perspective and in the context of today’s perceptions. Integrity of *association* exists where natural and manmade features convey a strong connection between the landscape and a contemporary observer’s ability to discern historic railroad operations.

RAILROAD SITE FEATURES

Railroad Grade Feature Types

Clinker Dump: Clinker is a dark, scoriaceous residue byproduct of burning fuel coal in locomotives, and it had to be shoveled out of boiler fireboxes regularly. Often this was done in yards, on sidings, and when locomotives took on fuel and water. Over time, the repeated disposal created distinct dumps.

Ditch: Ditches flanked rail beds and diverted drainage water.

⁷⁰³ McClelland, et al., 1999:21.

Grade: A grade is the rail bed and associated earthwork such as cuts, fills, and ditches. Grades were usually elevated berms with flattened surfaces, and paved with ballast such as gravel. Pitch rarely exceeded five percent, the traction limit of locomotives, and slope changes were gradual.

Main Line: A main line is the principal railroad track.

Rail Bed: A rail bed is the carefully leveled surface on a grade for the track.

Refuse Dump: When railroad companies conducted maintenance on their lines, they often threw unwanted refuse such as old ties, worn rails, stumps and junk into piles.

Siding: A siding was a minor track parallel and adjacent to a main line, and it allowed trains to stop for fuel, water, and to wait for passing traffic.

Spur: A spur was a dead-end track that diverted off the main line, and it was used to park cars and load freight.

Switch: A switch was the union of two tracks.

Track, Narrow-Gauge: A track was the assemblage of rails and ties on a rail bed. Narrow-gauge tracks were 3' wide between rails.

Track, Standard-Gauge: Standard-gauge tracks were 4' 8½" wide between rails.

Track Remnant: When tracks were dismantled, often only the rails and spikes were removed, leaving the ties in place. The ties, impressions left by ties, and scraps of rail in place constitute the remnant.

Wye: A wye was a type of intersection that joined two tracks at oblique angles. The wye featured curved approaches to the oblique extension that allowed trains to sweep from one track onto the other without breaking.

Drainage Structure and Tunnel Feature Types

Bent: A bent, also known as a pier, was a vertical structure supporting a bridge span. Bents were assemblages of posts tied with cross-members and diagonal braces. The outside posts were usually set at a batter, leaning inward from the structure base.

Bridge Abutment: An abutment was the bulwark that supported the ends of a bridge. Where possible, bedrock was used to support the bridge's structural elements. When this was unavailable, platforms had to be created. In early years, logs and timbers retained benches of rock fill, and in later years, footings of stone masonry and concrete were constructed.

Bridge, Multi-Span: A multi-span bridge featured segments supported by piers or bents.

Bridge, Single-Span: A single-span bridge featured one segment extending from abutment to abutment.

Culvert, Box: A box culvert consisted of a flat floor, vertical walls, and a flat ceiling buried by the railroad grade. Wood and concrete were the most common construction materials.

Culvert, Concrete: A concrete culvert usually featured a flat floor, vertical walls, and either an arched or flat ceiling. The size of the opening was significantly larger than that of a box culvert, and it usually featured headwalls.

Culvert, Masonry: A masonry culvert usually featured a flat floor and an arched ceiling made of stones.

Culvert, Pipe: A pipe culvert was little more than one or several pipes buried by railroad grade fill. Early pipes were wood or terracotta. By the 1890s, cast-iron pipes were common, and during the 1940s, corrugated iron and concrete pipes were popular.

Ditch: Ditches were excavated in minor drainages to direct runoff into and out of culverts.

Flume: A wooden, masonry, or concrete structure that carried water into or away from a culvert.

Tunnel: A tunnel was a bore through a rock obstruction. Tunnels had to be large enough to accommodate a steam locomotive.

Tunnel Portal: The entry into a tunnel was known as a portal, and it was usually finished with timber, rock masonry, or concrete facing.

Waste Rock Dump: Waste rock was the material generated by boring a tunnel. The waste rock was usually dumped at the tunnel mouth, where it formed a broad fan or lobe.

Right-of-Way Structure and Object Feature Types

Bumper Stop: Dead-end rail spurs and sidings featured bumper stops to prevent locomotives and cars from rolling off the end of the track. Most bumper stops were custom-made and assembled from salvaged rails or timbers, and others were factory-made of steel and featured spring-loaded bumpers.

Cistern: Where railroad tracks passed steep mountainsides, cisterns provided water for steam locomotives instead of traditional elevated water tanks. The cistern was located above the track and the water conveyed to the locomotive via a pipe and hose. A cistern was usually square or rectangular, assembled with stone masonry or poured concrete, and featured a pipe at bottom.

Coal Bin: Steam locomotives consumed enormous tonnages of fuel coal and had to stop at strategic points to replenish their supplies. Coal bins contained the fuel, and they were sloped-floor structures with chutes that unloaded the coal directly into locomotive tenders. The bins were rectangular, substantial, and elevated on pilings.

Coal Bin Ruin/Platform: When a coal bin was dismantled, it left archaeological evidence in the form of pilings, rock foundations, and an earthen footprint usually blanketed with bituminous coal.

Coal Dock: Coal docks were a smaller, less expensive alternative to formal bins. Docks were open, flat-bottom structures with low sidewalls, and they were similar in elevation to station platforms. Workers manually shoveled the coal from the dock into the locomotive tender.

Coal Dock Ruin/Platform: When coal docks were dismantled, they left archaeological evidence similar to coal bins, only the assemblage of materials was simpler.

Fence, Right-of-Way: Railroad companies constructed fences in open areas to both define their rights-of-way and keep livestock off tracks. Initially, fences featured wooden posts, later replaced with steel posts.

Fence, Snow: In the mountains, windblown snow had the potential to form drifts that blocked tracks and impeded railroad traffic. In response, railroad companies erected fences to alter localized wind currents and cause the snow to collect off the tracks. Picket fences assembled with slats and baling wire were the most effective but also costly, and where the wind was not fierce, railroad companies substituted buck-and-rail log fences.

Loading Dock: A loading dock was little more than an elevated plank platform that facilitated the transfer of freight into railroad cars.

Loading Dock Ruin: Ruins of loading docks can manifest as collapsed structures and outlines of pilings.

Mile Post: Mile posts usually stood at regular intervals along railroad lines and marked sequential distances from an important point such as a yard or station. Posts were either of wood or concrete and painted white with black numbering.

Pipeline: Pipelines conveyed water from collection points to places of use, usually a locomotive water tank. Collection points may have been springs, wells, or cisterns.

Pump: Pumps, mostly hand-operated, were anchored adjacent to locomotive water tanks, and they forced water up into the tank for storage.

Retaining Wall: In the mountains, retaining walls independent of the road grade were necessary on steep slopes to prevent loose material from rolling down onto the tracks. They ranged in construction from log cribbing to dry-laid masonry.

Road Crossing: Road crossings allowed wagons and automobiles to cross over railroad tracks. They featured ramp approaches, timber fillings between the rails, and occasionally warning signs.

Road Crossing Signal: Busy road crossings often featured electric signals that warned vehicles of approaching trains. The signals had electric lights, and occasionally audible warnings, signs, and gates.

Sand Bin: Railroad locomotives sprinkled sand on rails in front of the driving wheels to provide them with traction. The sand was stored in wooden bins alongside the tracks and shoveled into hoppers on the locomotive. The bins were similar to but smaller than coal docks.

Sand Bin Ruin/Platform: When sand bins were dismantled, they left structural evidence similar to that associated with coal docks, described above. Sand can be expected amid and around the ruin.

Sand House: Sand houses were sophisticated versions of the sand bins described above in the section on right-of-way structures. The typical structure included an enclosed bin elevated on piers so gravity could draw the sand into locomotives. In later years, a small conveyor lifted the sand into the bin.⁷⁰⁴

Snowshed: Railroad companies built snowsheds for two principal reasons. First was to protect rail lines from avalanches. In such cases, the sheds stood over tracks that crossed or passed below steep mountainsides. Second was to prevent snowdrifts from blocking rail lines. Avalanche snowsheds were robust, featured sloped roofs, stout walls, and presented a low profile. These characteristics bolstered the structures against the crushing forces of avalanches and allowed the snow to skim over the top. Snowsheds built for snowdrifts were not as stout and instead were lengthy frame buildings.

Snowshed Ruin: When collapsed, snowsheds left distinct archaeological evidence. Avalanche snowsheds tend to feature a heavily constructed upslope wall and structural debris on the downslope side for the length of the structure. Drift snowsheds offer light structural debris along their lengths, as well as timber footers.

⁷⁰⁴ Fraser, 1997:175.

Switching Device: A switching device consists of the mechanism and linkage that activated a track switch. For much of mountain railroad history, hand switches engaged with levers were common, and in later years, electric and pneumatic models were employed on main lines. The switch stand, where the controls were located, usually featured a sign.

Track Sign: Railroad companies installed signs at important points along tracks to convey information or warnings to train crews, maintenance employees, and the public. Examples include bridge and culvert numbers, derail points, highway signs, road crossings, road stop signs, section numbers, siding signs, slow points, snowplow posts, speed limits, station names, warning signs, whistle points, and yard limits.

Traffic Signal: Traffic signals, a twentieth century invention, helped different trains avoid conflict. By the 1910s, railroad companies installed signals with moveable arms that directed trains onto sidings or spurs. By the 1940s, signal lights became more common. The mechanical signals and light stands were parts of complex systems that were wired together, such that when one train was given the signal to proceed, trains in the opposite direction were directed to pull onto the nearest siding.

Traffic Signal Shed: The communications switches and wiring for traffic signal systems were enclosed in sheds alongside railroad tracks. The sheds were usually small frame structures or prefabricated sheet-iron boxes.

Utility Pole: Nearly all railroad tracks featured a series of utility poles off the road bed, and they carried wires for telephones, track signals, and occasionally electric power. Poles were typically logs with cross-members fitted with glass insulators, and some feature date nails.

Watchman's Cabin: Railroad companies employed watchmen who regularly surveyed sections of main lines for problems such as rockfall, fires, and bridge damage. They lived in small cabins at strategic points on the line where problems were most likely to occur. The cabins were simple, impermanent, one-room structures without facilities such as plumbing.

Watchman's Cabin Platform: When a watchman's cabin was removed, as most were, they left archaeological evidence in the form of cut-and-fill platforms with assemblages of domestic artifacts.

Water Tank: Steam locomotives consumed high volumes of water and had to replenish every five to ten miles in the mountains. Thus, railroad companies built tanks at various points along their lines. The typical tank was cylindrical, between 12' and 30' in diameter, elevated on pilings, and featured a hinged spout to direct water into a reservoir on the tender or locomotive. Nearly all tanks built prior to around 1900 consisted of wooden staves bound with steel hoops, and afterward, they were factory-made of sheet iron. Tanks required a source of water which, in the mountains, was usually piped from a spring or small reservoir. If the tank stood near a slope, then the pipe delivered the water directly into the top, and if not, then a worker operated a hand pump to lift the liquid.

Water Tank Platform: Railroad companies commonly relocated water tanks for use elsewhere, leaving evidence reflecting the tank's original placement. Remaining are concrete or stone footers for the pilings, an outline of the tank based on soil differentials, and structural debris, all adjacent to a rail bed.

Maintenance Facility Feature Types

Service Buildings

Blacksmith Shop – Typical Character-Defining Features

Blacksmiths manufactured hardware, sharpened tools such as picks, and repaired steel and iron parts. They did so in shops equipped with a forge, workbenches, hand tools, and mechanical appliances. The buildings were often vernacular in that they were designed by workers in the field to meet needs of blacksmithing, at little cost, with available materials. Shops were functional, industrial in appearance, and rarely followed an architectural style.

- Core Plan: Rectangular, open interior.
- Stories: 1 or 1½
- Foundation: Timber footers, crude stone, or concrete on earthen platform.
- Walls: Frame sided on exterior with planks, sheet iron, or tarpaper.
- Roof: Front- or side-gabled, with rafters, plank decking, and sheet metal or shingle cladding. Corrugated sheet iron, rolled asphalt, or asphalt shingles were common by around 1900.
- Chimney: Large-diameter stovepipe.
- Entry Door: Usually located in the front, broad, and made of vertical planks.
- Windows: Square or rectangular with frames made of milled lumber.

Car Shed – Typical Character-Defining Features

Car sheds were elongated buildings over one or two spur tracks, and they sheltered important railroad cars such as Pullman sleepers and snowplows. When building the sheds, the railroad company may have followed a standardized design or planned the building according to need, function, and budget.

- Core Plan: Rectangular, open interior.
- Stories: 1 but tall
- Foundation: Timber or concrete footers.
- Walls: Frame sided on exterior with planks, sheet iron, or tarpaper.
- Roof: Front-gabled, with rafters, plank decking, and sheet metal or shingle cladding. Corrugated sheet iron, rolled asphalt, or asphalt shingles were common by the 1900s.
- Chimney: None.
- Entry Door: Double doors usually located in both ends.
- Windows: Square or rectangular with frames made of milled lumber.

Carpentry Shop – Typical Character-Defining Features

Carpenters were extremely important to railroad operations because they maintained rolling stock and fabricated fine woodwork. Carpentry shops were equipped with mechanical appliances powered by a central steam engine or later by electric motors. The shops tended to be substantial in size, sometimes large enough to fit a rail car, and based on a standardized design or planned according to need, function, and budget.

- Core Plan: Rectangular, open interior.
- Stories: 1 or 1½
- Foundation: Timber footers, crude stone, or concrete on earthen platform.
- Walls: Frame sided on exterior with planks, sheet iron, or tarpaper.
- Roof: Front- or side-gabled, with rafters, plank decking, and sheet metal or shingle cladding. Corrugated sheet iron, rolled asphalt, or asphalt shingles were common by around 1900.
- Chimney: Large-diameter stovepipe.
- Entry Door: Usually located in the front, broad, and made of vertical planks.
- Windows: Square or rectangular with frames made of milled lumber.

Engine House – Typical Character-Defining Features

Engine houses were rare in the I-70 corridor, and those that may have existed were similar to enlarged barns. Known as square houses, they were rectangular in footprint, large enough for one or two locomotives, and stood over an equal number of spur tracks. The interiors were usually open and floored with earth, concrete, or asphalt.⁷⁰⁵ The design may have been standardized for the railroad industry or produced by the company engineer.

- Core Plan: Rectangular, open interior.
- Stories: 1 but tall, with clerestory
- Foundation: Masonry or concrete footers.
- Walls: Frame sided on exterior with planks, sheet iron, or tarpaper.
- Roof: Front-gabled, with rafters, plank decking, and sheet metal or shingle cladding. Corrugated sheet iron, rolled asphalt, or asphalt shingles were common by around 1900.
- Chimney: Louvered cupolas.
- Entry Door: Double doors usually located in both ends.
- Windows: Square or rectangular with frames made of milled lumber.

Machine Shop – Typical Character-Defining Features

Machine shops were among the most important railroad facilities because they serviced and fabricated parts for railroad equipment. Machine shops were equipped with mechanical appliances such as lathes, trip hammers, and threaders. Early shops were powered by a central steam engine and later by electric motors. The shops tended to be substantial in size, sometimes large enough to fit a rail car, and based on a standardized design or planned according to need, function, and budget.

- Core Plan: Rectangular or L-shaped, sometimes divided into rooms.
- Stories: 1 or 1½
- Foundation: Timber footers, crude stone, or concrete on earthen platform.

⁷⁰⁵ Fraser, 1997:167.

- Walls: Frame sided on exterior with planks, sheet iron, or tarpaper.
- Roof: Front- or side-gabled, with rafters, plank decking, and sheet metal or shingle cladding. Corrugated sheet iron, rolled asphalt, or asphalt shingles were common by around 1900.
- Chimney: Large-diameter stovepipe.
- Entry Door: Double doors made of planks usually located in front, and broad side-door made of vertical planks.
- Windows: Square or rectangular with frames made of milled lumber.

Oil House – Typical Character-Defining Features

Oil houses were storage sheds for petroleum products such as diesel fuel, gasoline, and lubricating oil. Fuels were usually stored in tanks plumbed to spigots and hoses, and lubricants were in barrels and cans. The structures were small, of frame construction, and sided with fireproof materials. In design, they may have been based on standardized plans or constructed as needed. Even when emptied of goods, tanks and petroleum stains are distinguishing characteristics.

- Core Plan: Rectangular or square.
- Stories: 1 or 1½
- Foundation: Timber footers or concrete on earthen platform.
- Walls: Frame sided on exterior with planks, sheet iron, or tarpaper.
- Roof: Front- or side-gabled, or shed, with rafters, plank decking, and sheet metal or shingle cladding. Corrugated sheet iron, rolled asphalt, or asphalt shingles were common by around 1900.
- Chimney: None.
- Entry Door: Vertical plank door in front.
- Windows: Square or rectangular with frames made of milled lumber.

Powerhouse – Typical Character-Defining Features

Power houses enclosed equipment that generated power for mechanical appliances in maintenance and switchyards. Prior to the 1910s, when steam drove most machinery, the buildings enclosed a boiler, a coal bin, a water tank for the boiler, plumbing, and possibly a pump. By the 1910s, electricity became popular, and small generators with steam drive engines were included. Powerhouses tended to be substantial in size and based on a standardized design or planned according to need, function, and budget.

- Core Plan: Rectangular or L-shaped, divided into engine and boiler rooms.
- Stories: 1
- Foundation: Timber footers, crude stone, or concrete on earthen platform.
- Walls: Frame sided on exterior with planks, sheet iron, or tarpaper.
- Roof: Front- or side-gabled, with rafters, plank decking, and sheet metal or shingle cladding. Corrugated sheet iron, rolled asphalt, or asphalt shingles were common by around 1900.
- Chimney: Boiler smokestack.
- Entry Door: Double doors made of planks usually located in front, and broad side-door made of vertical planks.
- Windows: Square or rectangular with frames made of milled lumber.

Privy – Typical Character Defining Features

A privy was a primitive toilet, consisting of a small building over an open pit. The interior featured a bench seat along one wall with one or two cut-out holes as a toilet seat.

- Core Plan: Rectangular or square.
- Size: 3'x4' to 5'x8' in plan.
- Foundation: Log or timber posts, log footers, or corner rocks around open pit.
- Walls: Post-and-girt frame, or corner posts with cross-members, sided with planks or sheet iron on the exterior.
- Roof: Front- or side-gabled, or shed, with plank decking, and rolled asphalt, asphalt shingles, or smooth or corrugated metal. Decking may span the walls or be fastened to wood rafters.
- Entry Door: Entries were usually vertical plank doors, sometimes opening onto a plank deck.

Storehouse – Typical Character-Defining Features

Storehouses were buildings for railroad materials and supplies. The buildings were rectangular, single-story, with gabled roofs and open interiors. Small storehouses stood on timber footers or concrete foundations, while large

versions were elevated on pilings or fill pads alongside railroad tracks. Windows were few and doorways broad. Railroad companies may have followed a standardized design or planned the building as needed.

- Core Plan: Rectangular, open interior.
- Stories: 1 or 1½
- Foundation: Timber footers, crude stone, or concrete. Pilings when adjacent to railroad track.
- Walls: Frame sided on exterior with planks, sheet iron, or tarpaper.
- Roof: Front- or side-gabled, with rafters, plank decking, and sheet metal or shingle cladding. Corrugated sheet iron, rolled asphalt, or asphalt shingles were common by around 1900.
- Chimney: None.
- Entry Door: Double doors or sliding doors made of planks usually located in front, and broad side-door made of vertical planks.
- Windows: Square or rectangular with frames made of milled lumber.

Warehouse – Typical Character-Defining Features

Freight was an economic mainstay of railroad companies, and they built warehouses at all principal points of commerce to receive and store goods. Small warehouses stood on timber footers or concrete foundations, while large versions were elevated on pilings or fill pads alongside railroad tracks. Windows were few and doorways broad. Railroad companies may have followed a standardized design or planned the building as needed.

- Core Plan: Rectangular, open interior.
- Stories: 1 or 1½
- Foundation: Timber footers, crude stone, or concrete. Pilings when adjacent to railroad track.
- Walls: Frame sided on exterior with planks, sheet iron, or tarpaper.
- Roof: Front- or side-gabled, with rafters, plank decking, and sheet metal or shingle cladding. Corrugated sheet iron, rolled asphalt, or asphalt shingles were common by around 1900.
- Chimney: None.
- Entry Door: Double doors or sliding doors made of planks usually located in front, and a broad side door made of vertical planks.
- Windows: Square or rectangular with frames made of milled lumber.

Tool House – Typical Character-Defining Features

Railroad companies built tool houses at almost every important node along a main line. The simple, frame buildings contained equipment and a hand car needed for regular maintenance work. The buildings were rectangular, single-story, rarely larger than 10'x15' in plan, with shed or gabled roofs.

- Core Plan: Rectangular or square.
- Stories: 1
- Foundation: Timber footers on earthen platform.
- Walls: Frame sided on exterior with planks, sheet iron, or tarpaper.
- Roof: Front- or side-gabled, or shed, with rafters, plank decking, and sheet metal or shingle cladding. Corrugated sheet iron, rolled asphalt, or asphalt shingles were common by around 1900.
- Chimney: None.
- Entry Door: Vertical plank door in front.
- Windows: Square or rectangular with frames made of milled lumber.

Service Structures and Archaeological Features

Blacksmith Shop Platform: Blacksmith shops left distinct forms of archaeological evidence when dismantled. The building's footprint, usually on an earthen platform, is often readily apparent and manifests as an outline of scorious dark clinker, which was residue created by burning coal in the forge. High portions of anthracite coal, clinker, and forge-cut iron scraps are characteristic artifacts.

Carpentry Shop Platform: Carpentry shops left distinct forms of archaeological evidence when dismantled, such as a footprint or an earthen platform, and an artifact assemblage of cut wood scraps, machine parts, and broken tools.

Clinker Dump: Clinker dumps can be found anywhere along railroad tracks, and they consist of the scorious residue left from burning coal, known as clinker. The dumps are created when the material is shoveled out of locomotive fireboxes.

Equipment Storage Area: Companies usually dedicated a small plot of ground near a rail spur to store ties, rails, supplies, and parts.

Fuel Tank: Diesel railroad engines and refrigerator cars needed to replenish fuel reserves en route across the mountains. Tanks at principal maintenance centers contained the fuel, and they were large steel cylindrical vessels on concrete foundations. Pipes directed the fuel to filling nozzles.

Fuel Tank Foundation: When removed, fuel tanks can be represented by circular or rectangular concrete pads, often stained with petroleum, and featuring plumbing.

Hoisting Derrick: A hoisting derrick was a primitive type of crane used to transfer heavy materials onto and off rail cars. The apparatus featured a timber boom, a mast, and a winch that pivoted on a small turntable bolted to a stout foundation. Derricks could be found on loading docks, in yards where pieces of equipment were stored, and near warehouses.

Hoisting Derrick Foundation: When dismantled, hoisting derricks left foundations of timbers, concrete blocks, or masonry pads studded with anchor bolts. The foundations should be located near a rail line.

Ice House: Prior to the widespread adoption of refrigeration, railroad companies kept tons of ice for three general purposes. The first two were company consumption among passengers and for shipping perishable goods in freight cars. The third was as a commercial commodity harvested in the mountains during winter, stored by railroad companies in ice houses, and distributed to urban areas as needed. Ice houses were relatively small, frame buildings insulated with sawdust, clinker, or sand, and often countersunk in the ground. Ventilation ports in the walls, fitted with coverings, prevented condensation in the interior.⁷⁰⁶

Ice House Ruin: Collapsed ice houses, which qualify as archaeological features, may be distinguished by their insulation-filled walls, countersunk arrangement, and ventilation ports.

Industrial Refuse Dump: Railroad workers often disposed of unwanted industrial debris in concentrated areas alongside railroad tracks and spurs, and around the fringes of yards. When substantial, the accumulation became a dump.

Loading Dock: Loading docks were traditional elevated plank platforms adjacent to rail lines, and they eased the transfer of freight and other materials into and out of rail cars.

Loading Dock Ruin/Platform: Loading docks, when dismantled, left archaeological evidence such as a footprint of debris, a raised earthen platform, or an outline of pilings.

Machine Shop Platform: Machine shops left distinct archaeological evidence when dismantled, such as a footprint or an earthen platform outlining the building, timber or concrete foundations for shop appliance, and metalwork debris.

Power House Foundation/Platform: When dismantled, powerhouses left characteristic archaeological features and artifacts. Foundations for the boiler, generator, drive engine, and coal bin lie within the building's footprint. The artifact assemblage includes a high portion of boiler clinker and small parts.

Privy Pit: The pit that underlay a privy. Privy pits are often less than 5' in diameter, feature a small pile of backdirt, and may be surrounded by refuse and ash. Footers for the privy building may be present.

Shop Dump: Shop employees threw debris generated by repair and fabrication work beside or behind shop buildings. When the accumulation became substantial, it became a dump.

Water Tank: Maintenance and service yards almost always featured a water tank for locomotives. The tanks were like those described above under right-of-way structures.

Yard, Freight: A freight yard was a set of features dedicated to receiving, storing, transferring, and shipping materials for customers. Freight yards often included a warehouse, hoisting derrick, loading dock, and storage area.

Yard, Maintenance: A maintenance yard was the entire collection of facilities dedicated to maintaining and servicing a railroad system and its equipment. Most of the features described above, as well as rail spurs, railroad grades, and workers' housing were usually located in such yards.

⁷⁰⁶ Fraser, 1997:175.

Section B 6: Pack Trail and Road Property Types and Registration Requirements

The I-70 corridor's transportation routes began as primitive pack trails and wagon roads, evolving into an engineered system designed to overcome topographic challenges in a mountainous environment. The end result is today's road and interstate system. Historic wagon routes, the basis for today's road network, allowed high country economies and communities to flourish. Most of the road network was constructed over original trails and wagon routes, modified and enlarged. Following are descriptions of the most common road Property Types in the corridor and registration requirements for evaluating them in terms of the NRHP. The information is a starting point for resource identification and evaluation. In 2002, Associated Cultural Resource Experts (ACRE) developed *Highways to the Sky: A Context and History of Colorado's Highway System* for CDOT. In 2003, the Colorado Office of Archaeology and Historic Preservation adapted *Highways to the Sky* into *Colorado Roads and Highways, National Register of Historic Places Multiple Property Submission*.⁷⁰⁷

The draft MPS outlines relevant Areas of Significance and registration requirements for roads, highways, and freeways post-dating 1909. Although the context is statewide, the information directly applies to resources in the corridor because its roads and highways largely followed statewide patterns. Thus, for brevity, universal Property Types are noted below but refer the reader to the statewide context or MPS for full descriptions.

Pack trails and roads should be recorded as linear resources, when whole or segmented. To describe and evaluate contributing segments, consult Appendix VI in *National Register Bulletin 16A: How to Complete the National Register Registration Form*. For information on bridges, consult the *Highway Bridges in Colorado: Multiple Property Submission*.⁷⁰⁸ Other common transportation-related buildings are mentioned in this context's Section A 10 on architecture. Segments of historic roads and trails exist, but few resources in entirety are expected to be in their original as-constructed condition. Early roads were altered through realignment, periodic paving, and other improvements. This can affect integrity by changing or removing character-defining attributes, but does not preclude eligibility if the resource sufficiently conveys its historic significance. The resources may qualify for nomination under a later Period of Significance as time passes and this context is updated. They can also be evaluated under NRHP Criterion Consideration G, recognizing exceptionally important properties that achieved significance within the last fifty years. Additional archival research will be required for specific resources.

The following Property Types are developed in this section:

Pack Trail

Wagon Road

Engineered State Roads and Highways

⁷⁰⁷ Autabee, Robert and Deborah Dobson-Brown. *Colorado State Roads and Highways: National Register of Historic Places Multiple Property Submission*. Denver, CO: Colorado State Historic Preservation Office, Colorado Historical Society, (draft) 2003.

⁷⁰⁸ Fraser, Clayton. *Highway Bridges in Colorado: Multiple Property Submission*. Denver, CO: Colorado State Historic Preservation Office, Colorado Historical Society, 2000.

PROPERTY TYPE: PACK TRAIL

Pack trails were crude, narrow transportation routes intended to accommodate pedestrians and pack animals. Many were intentionally graded; others evolved organically, and were in use beginning with the 1859 gold rush in Clear Creek drainage until automobiles became common by the 1920s. Two general categories of pack trails are relevant, defined by destination and era. The first are early trails predating wagon roads, traversed by miners and settlers moving through the I-70 corridor's valleys. In traveling between destinations, they chose the easiest routes with minimal climbing, shallowest stream crossings, and lowest mountain passes. Trails emerged from repeated and regular use, with minimal improvement. In constitution, the trails were one or several tracks constantly joining and separating, and cleared of principal obstacles. Those most heavily traveled eventually evolved into wagon and then auto roads, and so only short segments are likely to remain of early routes.

In the second category, pack trails were localized networks linking remote industrial or agricultural operations with settlements and transportation centers. Miners purposefully graded trails to difficult-to-reach mountain properties. Logging traffic created trails into areas of timber harvest. Cowboys established paths to line camps. Trails of organic origin were 2' to 6' wide, wound around obstacles, and featured a depressed surface. Steep ascents and slope contouring were common. Intentionally created trails were often improved with cut-and-fill construction on slopes, occasional retaining walls, and relatively constant and steep pitches. These trails were in use from the 1860s through the 1910s, and sometimes as late as the 1930s.

PROPERTY TYPE: WAGON ROAD

Wagon roads were the first well-developed and formally planned transportation network in the I-70 corridor. The gold rush and its need for efficient transportation, particularly wagons, incentivized entrepreneurs to construct roads into Clear Creek drainage as early as 1859. Mining drove road development on the Blue River during the 1860s, Ten Mile Canyon in 1878, and the Eagle and Colorado river valley during the 1880s. In choosing routes negotiable by wagon, toll road companies followed previously established pack trails. Initially, these toll roads were little more than wagon ruts cleared of the largest obstacles, but quality improved slightly after 1865 when the territorial legislature issued maintenance requirements.

Road builders employed rudimentary techniques in construction, primarily pick, shovel, earthen fill for divots, and cuts for the steepest slopes. The early roads were capable of accommodating wagons, but rough and narrow enough to restrict travel. Routes were as straight and direct as possible, favoring open and well-drained ground, gradual ascents, and few natural obstacles. But such routes were limited in the mountains, forcing road builders to adapt to immediate conditions. They constructed the earliest roads by clearing trees, stumps, and large rocks, and filling the deepest gullies and depressions with cobbles.

As wagon traffic and load weight increased, entrepreneurs, stagecoach companies, and mining companies invested more capital and manpower in better roads. Grades were widened to 20' in some areas and surfaces improved, with routes contouring across mountainsides on cut-and-fill beds. Pitches were usually steeper than the six percent defined for later automobile roads

and rarely paved with any material. Occasionally, however, roads were surfaced with small stones, screened gravel, or waste rock recovered from mines. Heavy rainstorms and spring snowmelt wreaked havoc by washing away road edges, eroding surfaces, and creating mud bogs in low areas. To combat washouts and erosion, road builders constructed primitive drainage control ditches and log cribbing or dry-laid rock walls to retain cut- and fill-banks. Planks covered perpetually muddy segments, although more often small trees or branches were laid across for a corduroy surface. Stream crossings were largely unimproved because most waterways in the I-70 corridor could be easily forded. But principal streams such as Clear Creek and Ten Mile Creek were too deep, especially in spring, requiring bridges. These structures typically consisted of logs spanning between gravel ramps retained by log cribbing or rock walls. If a river was too wide for a bridge, however, like the Eagle and Colorado, toll companies offered ferry crossings.

Few if any wagon roads are presently complete in entirety, having been segmented by the extant interstate, secondary highways, and other roads. Further, many remaining segments are no longer in their as-built condition due to later widening, resurfacing, reconfiguration, or bulldozing. Remaining segments retain integrity when they possess original surfaces, cuts and fills, pitches, and retaining walls and corduroy if used.

PROPERTY TYPE: ENGINEERED STATE ROADS AND HIGHWAYS

Engineered roads are routes purposefully designed for transportation, linking destinations as directly as practical. Aesthetics were a secondary consideration, and not at all for many roads. The Property Type ranges from rural gravel roads to two-lane drives to divided highways. *Colorado Roads and Highways, National Register of Historic Places Multiple Property Submission* defines a subtype entitled Limited Access, Multiple Lane, Divided Highway/Freeway. I-70 is likely the only highway in the corridor that qualifies for the category. For a full description of Property Type, subtype, and character-defining features, see the context.

PACK TRAIL AND ROAD PROPERTY TYPE SIGNIFICANCE

The Property Types above were components of local, regional, and statewide road transportation systems. Roads and pack trails fulfilled numerous functions important on local and regional levels. Initially, early roads and pack trails carried a flow of settlers into the I-70 corridor, facilitating initial exploration and settlement. Subsequently, roads and pack trails served local transportation needs, allowing an expansion of industry, communities, and other land uses. Eventually, the corridor's road network became links in statewide and national systems, with some highways, including U.S. 6 and U.S. 40, as vital segments. The Property Types can convey a number of NRHP Areas of Significance including Commerce, Community Planning and Development, Economics, Engineering, Industry, and Transportation.

The Period of Significance 1859 to 1962 covers pack trail and road transportation as a theme throughout the corridor. But individual roads and trails were important only when in service, thus narrower timeframes are applicable when assessing individual resources by region. Applicable Periods of Significance are: 1859 to 1962 in Clear Creek drainage, 1859 to 1962 in

Summit County, and 1870 to 1962 along the Eagle and Colorado rivers. Level of significance will be local, and possibly statewide or national depending on further research.

Area of Significance: Commerce: Roads were significant in the Area of *Commerce* because they facilitated trade of high volumes of goods among corridor communities, and with regions elsewhere in Colorado. Initially, drayage companies imported needed goods and hauled out products such as gold, silver ore, and agricultural yield. After railroads arrived, roads continued their key role linking stations with points of population and industry. Trucking companies resumed the import-export pattern in Clear Creek and Summit counties after railroads ceased operation in these regions. The roads also fostered tourism from the 1860s through 1962, one of the longest-lived forms of commerce.

Area of Significance: Community Planning and Development: Pack trails and roads were significant in the Area of *Community Planning and Development* because they influenced settlement patterns and were the reason for some corridor communities' existence. Pack trails and wagon roads facilitated initial settlement and subsequent growth of all towns in the corridor, reliant on pack trains, wagons, omnibuses, and stagecoaches for movement of freight and people. Those towns at crossroads eventually dominated as transportation centers, continuing this role as autos and trucks supplanted wagons. Roads navigable by automobile also allowed resource extraction communities to adapt to tourism and other forms economy when their resource bases became exhausted. Outdoor recreation in particular flourished because roads provided access. Those settlements without auto roads were unable to adapt and were abandoned.

Area of Significance: Economics: Roads were significant in the Area of *Economics* because they were a basis for regional economies and the movement of cash. Wagon roads and pack trails directly supported mining and logging on substantial scales in the Clear Creek and Blue River regions, economically dependent on these industries. Wagon roads allowed resource extraction companies to ship products to market and exchange them for wealth, some of which circulated through corridor communities. When railroads arrived, roads and pack trails carried local freight, still critical to industry and its economic impacts. Agriculture followed similar patterns along the Eagle and Colorado rivers. Auto roads facilitated a transition from natural resource extraction to tourism-based economies. Tourists then brought new money into corridor communities, spending it on lodging, services, and goods. Road construction and maintenance were local economic contributors in themselves, paying workers' wages and contractor fees.

Area of Significance: Engineering: The corridor's roads and highways are significant in the Area of *Engineering* as components of larger transportation networks. Regional roads may be significant on a local level while highways may be significant on a statewide level. Further research, however, is required to demonstrate this. Road builders overcame geographic obstacles when designing and constructing routes through the mountains, and many roads exhibit engineering principles common to the era in which they were constructed. Wagon road builders adapted route, width, curvature, and roadbed to existing conditions in mountains and canyons. Auto road builders, in contrast, modified mountain topography to accommodate the speed, performance limitations, traffic volume, and safety of autos.

Area of Significance: Industry: The corridor's pack trails and roads contributed in the Area of *Industry*. Pack trails, the earliest routes into the mountains, opened remote regions for small-scale industrial development. Wagon roads facilitated the first inexpensive transportation capable of hauling freight in commercial volume. In so doing, wagon roads fostered the growth of associated industry, primarily mining and logging in Clear Creek and Blue River drainages, and agriculture along the Eagle and Colorado rivers. Operating costs fell, machinery and other technologies could be hauled in at affordable prices, and rates for shipping products to market decreased substantially. Trucks traveling auto roads and, later, highways, had a twofold impact. They not only continued supporting industry as wagons previously did, but also replaced railroads when these carriers ceased service. Without trucks, industry would have otherwise declined with the railroads.

Area of Significance: Transportation: In the Area of *Transportation*, pack trails and roads were significant as the first constructed overland transportation system in the corridor. Pack trails and roads were primary in opening the corridor to industry, economic adaptation, and permanent settlement. Wagon roads subsequently supported ongoing growth of industry and communities by facilitating the movement of people, freight, and money. Products flowed out of the corridor, and industrial supplies, domestic goods, and money flowed in. The roads also made travel easier for people, enhancing the migratory pattern characteristic of the mountain west. Regional auto roads not only continued the above trends, but also encouraged the rise of auto tourism, which supplanted waning natural resource extraction industries. State highways may be significant on a statewide level as components of Colorado's state highway system, linking numerous regions and granting industries better access to markets. National highways may be significant on a national level as components of a national system and conduit for interstate trade and travel. Further research is, however, required for determination in both cases.

Pack Trail and Road Property Type Registration Requirements

To qualify for the NRHP, road resources must meet at least one of the Criteria listed below and possess adequate physical integrity to convey their significance.

Criterion A: Resources eligible under Criterion A must be associated with at least one Area of Significance noted above as well as contribution to a broad pattern of history.

Criterion B: Roads and pack trails may be eligible under Criterion B provided an association with the life of an important person significant in our past. Presence will probably be through employment, operations management, or construction. The resource must date to the same timeframe when the individual achieved significance, and retain physical integrity relative to the person's productive life. A brief biography is necessary to explain the individual's significant contributions. Important people invested in road companies or directed construction, but did not personally occupy a site. Such an association does not meet the registration requirements outlined here. The individual of note must have been present on-site in a meaningful capacity. In general, applying Criterion B is complex, and *National Register Bulletin 32: Guidelines for Evaluating and Documenting Properties Associated with Significant Persons* can provide further guidance.

Criterion C: Road Property Types may be eligible under Criterion C when they clearly exemplify or embody the distinctive characteristics of a type, period, or method of construction. Roads and trails can also be eligible if they are the work of a master engineer or contractor, or possess high artistic or engineering values. The last remaining segment of a previously larger road may qualify if it is representative example of that route.

Eligible roads and trails must possess a predominance of as-built aspects including surveyed route, bed and surface, cuts and fills, and other adaptations to environment during the Period of Significance. Most of the corridor's main roads have remained in use but have been widened, regraded, curves straightened, cut-and-fill slopes relaxed, and retaining walls updated. Such roads may be eligible if integrity sufficiently conveys design, materials, and workmanship during the period.

Eligible tunnels, retaining walls, and drainage facilities convey design, engineering, construction methods, and integration with the road. Tunnels must possess intact portals with original appearance and minimal alteration. Retaining walls should embody form, materials, and features of their structures. Drainage structures must be fairly intact, possess original components, and impart their design and function.

Small-scale features can be important contributing elements if they clearly convey their type, function, relationship with the road, and timeframe. Signs, mile posts, guardrails, streetlights, and similar small aspects must be relatively complete and in place.

Road Property Types may also be eligible if they are contributing elements of historic landscapes. When in an urban setting, the streetscape should be compatible in age with the road's physical embodiment, with the road contributing to the community's historic feeling. When in a rural setting, a road or pack trail should contribute to the feeling of period transportation in the area. If the resource is in a mining or logged setting, then it should convey its relationship between the industry and transportation. Nearby historic resources must be compatible in timeframe and possess integrity.

Criterion D: Road Property Types may be eligible under Criterion D if they are likely to yield important information upon further study. In general, the researcher must state the area of inquiry, why it is important, and how the resource will address the questions. Charting pack trail routes may reveal patterns of foot and draft animal traffic in remote areas. Detailed examination of road-related resources may reveal how engineers adapted road construction to challenging geographic conditions. Intensive survey and/or analyses of artifact assemblages may enhance existing knowledge regarding road construction and operations, maintenance, and behaviors of workers and travelers.

Eligible road Property Types must possess physical integrity relative to the Period of Significance. Roads and pack trails possess sufficient integrity when clearly conveying route, design, construction, materials, and use during the Period. Most principal routes have been continually traveled but heavily modified through widening, resurfacing, regrading of cut-and-fill-banks, and improved drainage. Heavily altered roads lack sufficient integrity for eligibility when alterations compromise Period characteristics.

Most of the seven aspects of integrity defined by the NRHP apply to road Property Types. A road or trail retains integrity of *location* when in its place of use during a Period of Significance. Realignment, for example, may compromise integrity of location. Intact structures and small-scale features must be in their original places of use to retain integrity of location. For integrity of *design*, material remains must convey the road's organization, planning, engineering,

and use. To retain integrity of materials, the physical substance used in structures should date to a road's Period of Significance. To retain the aspect of *setting*, the area surrounding the resource must not have changed a great degree from its operational timeframe. In terms of *feeling*, the road and associated aspects should foster a perception of period transportation from a historical perspective and from today's standpoint. Integrity of *association* exists where a road or trail conveys a strong connection between the resource and a contemporary observer's ability to discern historic transportation.

ROAD FEATURES

Roads possess a wide variety of engineered structures and objects representing their design, construction, maintenance, and use. The most common manifestations are explained as the Feature Types below, but the descriptions are brief. For greater detail, context, and uncommon types, researchers should also review three publications. One is *Colorado Roads and Highways, National Register of Historic Places Multiple Property Submission* for general descriptions of Colorado's roads, and other is *Highway Bridges in Colorado: Multiple Property Submission* for bridges. The third is *A Policy on Geometric Design of Highways and Streets*, also known as the *Green Book*, published by the American Association of State Highway and Transportation Officials beginning in 1937. Periodically updated, the manual provides specifications for all aspects of roadway design, with early editions a source of contemporary data.

Road Right-of-Way Feature Types

Ditch: Ditches flanked roadbeds and diverted drainage water.

Guardrail: Government agencies installed guardrails along road shoulders for both safety and to mark the roadway. Before standardization during the 1950s, guardrail types included post-and-cable, post-and-plank, post-and-rail, vertical pipe segments, and rock walls. Semi-rigid guardrails were introduced during the late 1930s, consisting of a convex steel band, or beam, fastened to springs bolted to timber posts. The W-beam, introduced during the 1950s and presently in use, is similar with a corrugated band.

Intersection: An intersection is a junction of two or more roads. To manage traffic, roads often joined at right angles, with a stop sign or traffic light stopping one or both directions. Intersections were key nodes in transportation systems, featuring information signs and sometimes businesses. By the 1970s, intersections were widened for turn lanes and pedestrian crosswalks.

Rest Area: Constructed on primary highways, rest areas were places for motorists to pause on long trips. They evolved from pullouts with trash receptacles to designed, park-like environments with picnic tables and bathrooms. Most in the corridor, and all those along I-70, are less than fifty years old.

Ramp: I-70 features on- and off-ramps to carry traffic onto or off the roadbed. Ramps follow design guidelines, with markers or structures separating them from directional lanes, and signs designating function and destination.

Retaining Wall: Where roads crossed steep terrain, walls were necessary to retain loose material, roadbeds, and the sides of cuts. Construction and materials varied in time, place, and need. Types include log or timber cribbing, planks retained by posts, rock masonry, concrete blocks, poured concrete, and chain link fencing.

Roadbed: A roadbed is the carefully leveled surface on a grade for the road surface, often pavement. Slightly elevated for drainage, beds featured a basement layer of crushed rock and a layer of sand or fine gravel. Macadam was a type of basement layer in which cobble size increased with depth, facilitating drainage. Beds were wide enough for the pavement and a shoulder, 4' during the 1920s and 1930s, and 10' wide for highways by the 1950s.

Road Right-of-Way: A road grade is an engineered route consisting of roadbed, shoulders, right-of-way structures, and associated earthwork such as cuts, fills, and ditches. In surveying grades, engineers sought consistency in pitch, preferably less than six percent, and in radii of curves, modifying topography with cuts and fills as needed when budget allowed.

Road Pavement: Pavement was a prepared surface intended to interface between traffic and a roadbed. Pavement types evolved over time, with overlapping, gradual transitions. Primary roads: gravel or oiled surfaces, 1890s-1920s; concrete, 1910s-1950s; asphalt, 1940s-present. Secondary and tertiary routes were paved with any of the above, depending on traffic volume and jurisdiction. By the 1950s, directional lanes on highways were 15' wide.

Runaway Truck Ramp: I-70 features several runaway truck ramps on both sides of the Eisenhower-Johnson Tunnel crossing, the west side of Vail Pass, and in Mount Vernon Canyon. The ramps utilize combinations of soft substrate such as gravel, collision barrels, and gravity to slow vehicles with faulty brakes. Well-marked, the ramps provide immediate transition from pavement to deep gravel.

Scenic Overlook: A character-defining feature of aesthetic roads and highways, scenic overlooks were pullouts or, on I-70, ramps allowing motorists to stop at observation points. Pullouts usually had identifying signs, and deceleration and acceleration lanes.

Drainage Structure and Tunnel Feature Types

Bent: A bent, also known as a pier, was a vertical structure supporting a bridge span. Bents were assemblages of posts tied with cross-members and diagonal braces. The outside posts were usually set at a batter, leaning inward from the structure base.

Bridge Abutment: An abutment was the bulwark supporting the ends of a bridge. Where possible, bedrock was used to support the bridge's structural elements. When this was unavailable, platforms had to be created. In early years, logs and timbers retained benches of rock fill, and in later years, concrete on earthen fill was used.

Bridge, Multi-Span: A multi-span bridge featured segments supported by piers or bents.

Bridge, Single-Span: A single-span bridge featured one segment extending from abutment to abutment.

Bridge Pier: Multi-span bridges were supported by piers, which were columns of poured concrete, precast concrete sections, or steel girders.

Culvert, Box: A box culvert consisted of a flat floor, vertical walls, and a flat ceiling buried by the road grade. Wood and concrete were the most common construction materials.

Culvert, Concrete: A concrete culvert usually featured a flat floor, vertical walls, and either an arched or flat ceiling. The size of the opening was significantly larger than that of a box culvert, and it usually featured headwalls.

Culvert, Masonry: A masonry culvert usually featured a flat floor and an arched ceiling made of stones.

Culvert, Pipe: A pipe culvert was little more than one or several pipes buried by roadbed. Early pipes were cast-iron, and during the 1940s, corrugated iron and concrete pipes were common.

Ditch: Ditches were excavated in minor drainages to direct runoff into and out of culverts.

Flume: A wooden, masonry, or concrete structure that carried water into or away from a culvert.

Tunnel: A tunnel was a bore through a rock obstruction. Tunnels had to be large enough to accommodate trucks and overhead lighting and utilities.

Tunnel Portal: The entry into a tunnel was known as a portal, and it was usually finished with rock masonry or concrete facing.

Utility Box: Utility boxes often stood at one of a tunnel's portals, enclosing circuitry for electric lighting and traffic signals. The boxes were prefabricated steel, usually on concrete pads.

Waste Rock Dump: Waste rock was the material generated by boring a tunnel. The waste rock was usually dumped at the tunnel mouth, where it formed a broad fan or lobe.

Right-of-Way Structure and Object Feature Types

Fence, Right-of-Way: CDOT and FHWA constructed fences along highways to both define rights-of-way and keep people and animals away from traffic. Initially, fences featured single or double strands of barbed wire stapled to wooden posts. By the 1960s, they had three strands of barbed or smooth wire lashed steel posts.

Fence, Snow: In the mountains, windblown snow had the potential to form drifts impeding traffic. In response, government agencies erected fences to alter localized wind currents and cause the snow to collect off the road. Picket fences assembled with slats and baling wire were the most effective but also costly. Rows of evergreens or buck-and-rail log fences were substituted where the wind was not fierce.

Jersey Barrier: Jersey barriers became common during the 1970s for a variety of separation, safety, and retaining functions. Pre-cast in sections for portability, they are around 3' high and flare outward at the base for stability. The concave sides were designed to maximize safety during impact, redirecting vehicles back onto the roadway with minimal risk of rollover.

Mile Marker: Replacing mile posts, mile markers were steel signs marking distance at regular intervals along federally designated highways. Black numbering was painted, and later in decal, on white steel sheet.

Mile Post: Mile posts stood at regular intervals along federally designated highways marking sequential distances from an important point. Posts were either of wood or concrete and painted white with black numbering.

Retaining Wall: In the steep terrain, retaining walls independent of the road grade were necessary to prevent loose material from rolling down onto pavement. On wagon roads, the walls took form as log cribbing or dry-laid masonry. On engineered roads, they were timber cribbing, mortared masonry, concrete blocks, poured concrete, chain link, or jersey barriers.

Road Sign: Government agencies installed signs at important points along roads to convey information, safety warnings, control traffic, and identify route. Examples include bridge and culvert numbers, travel distances, railroad crossings, stop and yield signs, speed limits, place names, warning signs, whistle points, and yard limits.

Traffic Signal: Traffic signals, a twentieth century invention, controlled traffic at busy intersections. Suspended from overhead wires, and later by dedicated poles, signals featured a series of red, yellow, and green lights informing motorists whether to stop, prepare to stop, or proceed.

Traffic Signal Control Box: The switches and wiring for traffic signal systems were enclosed in prefabricated steel boxes alongside intersections.

Utility Pole: Many primary and secondary roads featured a series of utility poles carrying wires for telephones and electric power. Poles were typically pressure-treated logs with cross-members fitted with porcelain insulators, and some feature date nails.

Section B 7: Tourism and Recreation Property Types and Registration Requirements

The Property Types described below reflect recreation and tourism common in the I-70 Mountain Corridor between 1859 and 1962. Itemized descriptions of specific resource features have been added to the section's end to refine the interpretation of historic resources.

The following property types and subtypes are developed in this section:

- Ski Area
- Resort
- Outdoor Recreation Site
 - Fishing Camp
 - Hunting Camp
 - Campground
 - Picnic Ground
 - Trailhead/Trail

PROPERTY TYPE: SKI AREA

A ski area is a large tract of ground, often an entire mountainside, where the natural environment has been modified for alpine skiing, also known as downhill skiing. Private interests developed the earliest ski areas in the I-70 corridor during the mid-1930s, with the sport growing in popularity, sophistication, and land use through 1962. Although specific attributes evolved over time, the basic ski area template remained largely constant. A developer, at first in the form of local ski clubs and later as corporations, cut ski runs through forest by felling trees so skiers could enjoy an unbroken descent. From the mid-1930s through 1960s, runs tended to be narrow, short, fairly straight, and on natural terrain. During the 1960s, developers and industry experts began planning runs for increased numbers of skiers, faster speeds, and improved ability. Runs became wider, longer, and curved, traversing varied topography. Developers also planned runs in groupings designed to funnel skiers down to a base area.

The base area was a collection of skier facilities at the bottom of the runs. At most early resorts, the base area was little more than a heated building known as a warming hut, with nearby outhouse or toilet, and parking. Warming huts were frame or log cabins with open interior, bench seats, and tables. Ski area operators improved base areas during the 1950s and 1960s, attracting greater numbers of skiers. Lodges with bathrooms, waiting rooms, offices, and even food and rental service replaced warming huts. Over time, operators added individual buildings for equipment, ski patrol, instructors, generators, and air compressors for snow-making systems.

Methods and technology for moving skiers to the top of a run evolved over time. Prior to the late 1940s, skiers had to walk at primitive areas, with tow ropes dragging them up at company-run operations. A tow rope consisted of an endless cable loop passing around pulleys at the run's top and bottom, and skiers held a handle or sat on a seat attached to the cable. A gasoline engine powered the system. By the 1950s, ski area developers began installing chairlifts that ferried skiers to the top. Similar to the Hallidie aerial tramway used for mining, the lift featured a series of seats suspended from an endless cable loop, passing around large sheave

wheels in top and bottom terminals. A motor kept the loop in constant motion, and a skier quickly sat on a seat as it passed around the wheel for the trip up to the top. The operator controls were originally in the open, and by the 1950s, in booths at top and bottom terminals.

In some cases, ski areas feature clusters of related Property Types. A base area, for example, may include a lodge, skier services building, maintenance facilities, and a lift. Cohesive assemblages of resources may qualify as historic districts when contributing elements and integrity sufficiently convey the Property Types and their significance. Operating ski areas are complex with multiple components, and may require further guidance for recordation and evaluation. If the ski area qualifies as a designed landscape, readers may refer to *National Register Bulletin 18: How to Evaluate and Nominate Designed Historic Landscapes*. To describe and evaluate contributing road segments and ski lifts, consult Appendix VI in *National Register Bulletin 16A: How to Complete the National Register Registration Form*. Both publications are available at History Colorado and the National Park Service.⁷⁰⁹ Ski lifts are not specified in the Bulletin but can be addressed similarly to railroads. Common ski area features are listed at the subsection's end, and universal building types in and around ski areas in Section B 8.

Two of the corridor's four operating ski areas, Copper Mountain and Beaver Creek, are less than fifty years old, and do not qualify as historic resources. They may, however, qualify for nomination under a later Period of Significance as time passes and this context is updated. They can also be evaluated under NRHP Criterion Consideration G, recognizing exceptionally important properties that achieved significance within the last fifty years.

The corridor's other two areas, Loveland and Vail, are more than fifty years old but have been impacted through replacement of materials, equipment, and structures, as well as new runs and facilities. Eligibility might not, however, be precluded. The resources in entirety, or portions therein, could be eligible if present character-defining attributes date to a Period of Significance and sufficiently convey resource significance. The portions heavily modified within the last fifty years may qualify under a later Period of Significance or NRHP Criterion Consideration G as noted above.

Ski Area Significance

Ski areas and cross-country trail networks may be significant in the Areas of Architecture, Conservation, Economics, Engineering, Entertainment/Recreation, Industry, Landscape Architecture, and Politics/Government. In general, the Period of Significance 1860 to 1962 covers skiing as recreation in the I-70 corridor. But the development of skiing was not uniform in the corridor, and narrower timeframes may be more applicable in specific regions. The Periods of Significance, by region, began in 1860 in Clear Creek drainage, 1878 in Summit County, and 1887 along the Eagle and Colorado rivers. Designed ski areas may have their own individual Periods of Significance, as well, covering operating years. Level of significance will be local, although some resources may be statewide or national, depending on further research.

Area of Significance: Architecture: Early warming huts, dating to the 1930s and 1940s, were significant as predecessors to ski lodges, among the most important buildings associated with the ski industry. Warming huts served as meeting points for skiers, as well as places of shelter and warmth during rest periods. Some offered services including food and equipment rental, also

⁷⁰⁹ Keller, J. Timothy; Keller, Genevieve P.; and Land and Community Associates *National Register Bulletin 18: How to Evaluate and Nominate Designed Historic Landscapes* National Park Service, n.d.; *National Register Bulletin 16A: How to Complete the National Register Registration Form*. National Park Service, 1997 [1977].

housing administrative offices. Although small and simple buildings, the huts provided a model in function, accessibility, and integration into a ski area that ski lodges later emulated.

Ski lodges and associated skier services buildings were significant as prominent icons of downhill ski areas. The buildings were among the most architecturally accomplished around a ski area, intended to be visually prominent as a primary point of public contact. Through these qualities, the buildings conveyed an identity of skiing as recreation and business.

Service buildings were significant for providing support critical to on-going ski area operations. Some were custom-designed and others prefabricated, and all were expected to withstand heavy use and wear within difficult environmental conditions, while costing little to construct. To meet changing needs in function and location, maintenance buildings tended to be simple, utilitarian in appearance, and periodically modified or moved.

Areas of Significance: Conservation and Politics/Government: Skiing contributed to the rise of *Conservation* and related *Politics/Government* in Colorado. Ski areas in particular were a vehicle that helped public land agencies transition from an emphasis on natural resource production to recreation. Ski areas depended on large acreages of mountain terrain, primarily owned by the U.S. Forest Service. During the 1940s, the Forest Service began examining land under its jurisdiction for suitable sites in an effort to promote skiing and associated economic benefits. When a ski industry took form, the Forest Service became a partner in area planning and land use for winter recreation in general. This trend applied to cross-country skiing, as well. As skiing grew in importance, Forest Service policy and culture gradually shifted toward managing land for recreation as much as other uses. Due in part to skiing, the Forest Service now considers recreation the primary use of its land in Colorado.

Skiing also factored into the development of conservation policies. Heavy recreational use and the development of ski areas impacted public land and the quality of its natural environment. In response, the Forest Service developed its own conservation policies and, after 1969, began applying other federal policies such as the National Environmental Protection Act for recreational development. Application of the policies ranged in geography from individual districts, to National Forests, to the Rocky Mountain region. In parallel, county governments also devised their own conservation policies due in part to ski areas and related development, applicable to local public land. Summit County was among the earliest, passing local ordinances in response to the development of Keystone ski area in 1970.

Area of Significance: Economics: The sport of skiing, and ski areas in particular, was significant in the Area of *Economics* on a local level. Cross country skiing and ski areas had a substantial local impact in several ways. They were mechanisms that drew money from distant sources, funneling it into mountain communities. Tourists coming from elsewhere in Colorado, the nation, and even the world spent money on food, lodging, ski area and event tickets, and other services. Also, ski area investors provided additional money as capital for property acquisitions and development, and ski area operations. The contributions helped many mountain communities transition from cyclical natural resource extraction industries to sustainable economies.

Area of Significance: Engineering: Ski areas were significant as places where advanced engineering was applied in unique ways to outdoor recreation. Engineering was essential for designing and constructing a competitive ski area attractive to users. On a macro scale, skiing experts and engineers considered numerous factors in overall ski area design, integrating runs, catwalks, access roads, service facilities, lifts, and mechanical systems with available topography, vegetation, and other natural features. Construction of individual runs and their

designation as beginner, intermediate, or expert was a function of technical data including slope gradient, run width, line-of-sight, and small-scale features. Lifts were complex engineered systems requiring exacting surveying and construction, and knowledge of performance and capacity for selection of appropriate components. Usually, ski area developers contracted with lift manufacturers for necessary guidance. Other mechanical systems involved advanced engineering, such as a localized electric power and lighting grid, and artificial snow-making, a complex network of water and compressed air plumbing. Further research may reveal specific contributions in the field among the corridor's ski areas. All, however, contributed to some degree through their individual adaptations of engineering for outdoor recreation.

Area of Significance: Entertainment/Recreation: Skiing was significant in the Area of *Entertainment/Recreation* for evolving from a practical form of winter transportation to an important means of enjoyment, socializing, and developing a relationship with the natural environment. Colorado's early settlers skied out of necessity, but established an activity that mountain communities adopted for recreation within a short time. Between 1880 and 1920, both cross-county and downhill skiing became an important activity for social events, fitness, and enjoyment of nature. By the 1950s, leisure-driven American culture accepted the sport as a mainstream form of recreation, which then exerted an influence on a culture that increasingly valued outdoor activities.

Area of Significance: Industry: Ski areas were significant in the Area of *Industry* by supporting their host communities and neighboring towns. As major employers, a foundation of general tourism, and engines of commercial growth, ski areas increased property values and real estate development. Ski areas also extended seasonal economies, previously peaking with tourism and natural resource extraction during snow-free months.

Beyond immediate communities, ski areas were part of and contributed to complex commercial and economic systems. Ski area operators often acquired machinery and other goods from suppliers in Denver and outside Colorado, with European firms often providing chairlifts and trained experts needed for their engineering. Similarly skiers came from within Colorado, elsewhere in the nation, and even Europe, spending money on travel, communications, food, and retail. Given this, ski areas supported economic systems extending outside of their host communities.

Area of Significance: Landscape Architecture: Ski areas and cross-country trail systems are significant in *Landscape Architecture* because they represent the molding of entire mountains and drainages for recreation. Ski industry planners purposefully altered the landscape with systems of trails, ski runs, infrastructure, and skier services. No longer a simple sport by the 1950s, skiing came to depend on large-scale landscape design, engineering, and mechanical systems.

Ski Area Registration Requirements

To qualify for the NRHP, ski areas and cross-country trail systems must meet at least one of the Criteria listed below and possess adequate physical integrity to convey their significance.

Criterion A: Resources eligible under Criterion A must be associated with at least one Area of Significance noted above as well as a contribution to a broad pattern of history.

Criterion B: Ski areas and cross-country trail systems may be eligible under Criterion B provided an association with an important person. The resource must date to the same timeframe when the individual achieved significance, and retain physical integrity relative to the person's productive life. A brief biography of the individual is necessary to detail their significant contributions and involvement with the property. In some cases, important people established or invested in ski areas but did not occupy the property. Also, important people such as famous cultural figures and leaders visited ski areas. Such an association does not meet the registration requirements outlined here. The individual of note must have been present on-site in a meaningful capacity. In general, applying Criterion B is complex, and *National Register Bulletin 32: Guidelines for Evaluating and Documenting Properties Associated with Significant Persons* can provide further guidance.

Criterion C: Downhill and cross-country ski areas may be eligible under Criterion C if the built environment is a good representative example of significant architecture adapted to skiing as recreation. Similarly, a ski area may be eligible if its structures and objects are good examples of significant recreational engineering types or designs. The overall assemblage of buildings, structures, and environmental modifications may also be a sound example of design and land use specific to skiing. Character-defining features must be evident, even if on an archaeological level. The ski runs, lift system if any existed, base area, associated buildings, and other facilities should be discernible. Ski areas may be further eligible under Criterion C if they are a product of an important architect, planner, or builder. The buildings and structures, or the entire complex itself, may be an example of the individual's skills, style, interpretations, and vision for skiing. Ski areas may be eligible as historic recreational landscapes. Even when a building or structure appears unimportant individually, it may provide context or belong to a larger district representing an area's recreational history.

Criterion D: Buildings, structures, and land use modifications often left archaeological evidence when removed or abandoned. When this evidence clearly represents a ski area during an important timeframe, then the site retains integrity on an archaeological level. For archaeological remains to retain integrity, the material evidence should permit the virtual reconstruction of the ski area and characteristic land use patterns. If archaeological features and artifacts are likely to yield important information regarding ski area design and operation, or skiing as recreation, then the site may qualify under Criterion D.

Eligible downhill and cross-country ski areas must possess physical integrity relative to their Period of Significance. Some ski areas have been abandoned and their buildings and structures dismantled, leaving archaeological features. A ski area possesses sufficient integrity on an archaeological level when material evidence clearly represents time period, design, facilities, and general function. Those ski areas presently in operation have been modified during the last fifty years with varying impacts to integrity. Most were expanded with additional runs,

lifts, other structures, and buildings. Further, aging facilities have been replaced by newer versions at all the areas. Eligibility of the areas, in entirety, might not be precluded if present character-defining attributes sufficiently convey significance. The resources may otherwise qualify for nomination under a later Period of Significance as time passes and this context is updated. They can also be evaluated under NRHP Criterion Consideration G, recognizing exceptionally important properties that achieved significance within the last fifty years.

Many of the NRHP aspects of historic integrity apply to ski areas, although not all need be present. To retain integrity of *location*, a structure or building should be in a place of functional use. To retain integrity of *design*, a ski area's material remains must convey the organization and planning of the run network, chairlifts, support facilities, and base area. To retain *setting*, the ski area and the surrounding mountainside must not have changed a great degree from its period of use. In terms of *feeling*, the resource should convey skiing from a historical perspective and in the context of land use today. Integrity of *association* exists where structures, buildings, and archaeological features convey a connection between a ski area and a contemporary observer's ability to discern skiing during the Period of Significance.

PROPERTY TYPE: RESORT

Resorts were businesses specializing in lodging, dining, and recreation for vacationing tourists. Although this resource category existed in the corridor between 1866 and 1941, it saw peak popularity from 1878 until 1920. Most resorts of the era were quality hotels and restaurants where tourists came for extended time. At a minimum, the enterprises included a hotel building, carriage house, storehouse, privies, and manicured gardens when land was available.

The hotel itself was a large building designed to accommodate numerous guests in private quarters and provide them with expected services. Most if not all hotels were architect-designed, but basic in overall form. They were usually stately, two stories in height, rectangular or L-plan, with front massing and porches intending to impart a sense of permanence. Roofs were side- or front-gabled, sometimes hipped, with dormers, and the walls were brick or stone masonry or frame construction sided with clapboards or lapped planks. Ornate trim and established architectural style of the era such as Queen Ann conveyed elegance.

Carriage houses, usually to one side or behind the hotel, housed buggies, tack hardware, supplies, and sometimes staff. The buildings ranged widely in form, construction, appearance, and origin. Simple versions were vernacular, planned on the grounds by the contractor for function, and unadorned in appearance. They were front- or side-gabled, rectangular, one to one and one-half stories in height, with barn doors. Luxury hotels had professionally designed carriage houses rectangular or L-shaped in plan, one to two stories high, with gabled roofs, multiple doorways, and an architectural style compatible with the hotel.

One of the most important roles of a resort was a base from which guests enjoyed recreational activities, either at the resort or elsewhere in the region. In fulfillment of the latter, resorts were usually located near areas of interest, connecting guests with services for outdoor excursions. Inclusive resorts themselves often provided the services, such as box meals, guides, and transportation on horses or buggies. Stables, carriage houses, and small corrals were usually somewhere close to such hotels, and associated with access roads. To describe and evaluate

contributing segments, consult Appendix VI in National Register Bulletin 16A: *How to Complete the National Register Registration Form*.

Large resorts built their own facilities and amenities for outdoor recreation on or near the grounds. Gardens and maintained landscapes were common at resorts with available land, planted with imported and native species tolerant of local climate. Indigenous trees were thinned, with fruit trees, shrubs, and ornamentals capable of surviving drought and freezes added. Gazebos, pavilions, and outdoor benches were not only built in gardens, but also at nearby vantage points, streams, and meadows. Resorts at or near lakes, such as Green Lakes above Georgetown, took advantage of their environment, featuring docks, skiffs, and fishing platforms.

Of all the resorts, those involving hot springs were the most elaborate, luxurious, and complex. The Natatorium and other Idaho Springs resorts, and Siloam Springs east of Glenwood Springs, drew tourists interested in luxury and bathing. In addition to the buildings and grounds described above, they also had facilities celebrating their heated and mineralized water, used for both bathing and drinking. Hot springs resorts featured steam rooms, bathhouses, indoor and outdoor pools, and ornamental and drinking fountains. Infrastructure such as wells, developed springs, channels, and pipes tapped water from the ground, blended it to tolerable temperatures, and shunted it to points of use. When examining resort sites today, researchers should look for evidence of all the above aspects. Other support facilities may be present at isolated resorts, such as fresh water cisterns or wells upslope, privy pits behind, and sewer outlets and refuse dumps downslope. A list of common resort features can be found at the subsection's end. Motels and universal building types are detailed in Section B 8.

Resort Significance

Resorts, a cornerstone of tourism and recreation in the I-70 corridor, were associated with Areas of Significance including: Architecture, Economics, and Entertainment/Recreation. Although the general Period of Significance applicable to recreation as a theme spans 1860 to 1962, narrower timeframes may be regionally applicable. Clear Creek County spanned 1866 to 1941, and the Blue River drainage from 1882 through 1920. Along the Eagle and Colorado rivers, resorts thrived between 1887 until 1893. Level of significance will be local.

Area of Significance: Architecture: Resorts were significant in the Area of *Architecture* for several reasons. Tourist-oriented hotels in corridor towns were among the earliest large-scale architectural foci, continuing as local icons to the community. Hotels contributed to the introduction and evolution of urban architecture in mountain communities through their design, construction, function, and overall appearance. Further, the hotels conveyed architectural style, influencing local precedent. Resorts, especially those involving hot springs, reflected adaptation of professionally designed commercial architecture to the mountains. In planning resorts, architects molded contemporary design, form, and construction to local conditions, materials, and needs of mountain tourism as a business. Influential conditions included capital, natural landscape features, local climate, and available building materials.

Area of Significance: Economics: Resort tourism contributed to the economies of mountain communities during initial development. When tourists stayed in hotels, dined, and used local services, their demand directly supported business sectors such as lodging, transportation, and food suppliers. Also, tourists brought money from the outside and spread it through the

community. In so doing, tourists fostered mountain commerce and contributed to the growing complexity of regional economies. By the 1880s, resort tourism became one of the most sustainable economic contributors in the mountains. Mining and logging, the principal industries, were foundations for regional economies. But because these industries were based on resource extraction, they underwent boom and bust cycles, creating instability. Resort tourism, by contrast, depended on patrons from distant cities and towns unaffected by local and even statewide economic cycles. Tourists continued coming during local economic downturns, translating into greater stability. Further, resort tourism was sustainable as long as resorts and the natural environment existed.

Area of Significance: Entertainment/Recreation: Resorts were places of enjoyment, relaxation, entertainment, and health for thousands of people over many decades. People used resorts to temporarily escape their daily routines, urban settings, and stress of modern life. Resorts also provided structure and a safe environment for recreation, which was relatively new during the nineteenth century. At the time, recreation was perceived as primarily for the wealthy. But as affordable resorts increasingly became available from the 1860s through the 1910s, recreation gradually evolved into a cultural norm and even rite among a growing middle class. Resorts were platforms by which the dominant culture valued the natural environment and outdoor activities. Tourists came to resorts and hotels in the corridor specifically to enjoy the Rocky Mountains. By hiking, picnicking, fishing, and enjoying excursions, tourists learned to appreciate nature for its various qualities, and even developed lifelong relationships with the environment. The trend expressed in the corridor was part of a broader national shift.

Resort Registration Requirements

To qualify for the NRHP, a resort must meet at least one of the Criteria below and possess adequate physical integrity to convey its significance.

Criterion A: Resorts eligible under Criterion A must be associated with at least one Area of Significance noted above as well as a contribution to a broad pattern of history.

Criterion B: Resorts may be eligible under Criterion B provided an association with the life of an important person significant in our past. Presence will most likely be through residence, employment, or other involvement with the tourist operation. The resource must retain physical integrity relative to that person's productive life. A brief biography is necessary to detail the individual's significant contributions. In some cases, important people established or invested in hotels and resorts but did not occupy the property. Also, important people such as famous cultural figures and leaders vacationed at resorts. Such an association does not meet the registration requirements outlined here. The individual of note must have been present on-site for a sustained time. In general, applying Criterion B is complex, and *National Register Bulletin 32: Guidelines for Evaluating and Documenting Properties Associated with Significant Persons* can provide further guidance.

Criterion C: Resorts may be eligible under Criterion C if the buildings are representative examples. The overall assemblage of buildings, structures, and landscape may also be a sound example of design and land use specific to resort tourism. Character-defining features must be evident. Resorts may further be eligible under Criterion C if they are a product of an important architect, planner, or builder. The principal resort buildings, or the entire complex itself, may be

an example of the individual's style, interpretations, and vision for recreational resorts. Contributing resources may provide context or belong to a larger district representing an area's recreational history.

Criterion D: Buildings, structures, and land use modifications often left archaeological evidence when removed or abandoned. When this evidence clearly represents a resort during a Period of Significance, then the site retains integrity on an archaeological level. For archaeological remains to retain integrity, material evidence should permit the virtual reconstruction of the resort and characteristic land use patterns. If archaeological features and artifacts are likely to yield important information regarding resort design and operation, or aspects of resort-based recreation, then the site may qualify under Criterion D. The property can also qualify if its surface artifacts or buried archaeological deposits are capable of addressing important research questions. The demography and behavior of tourists and resort staff are areas of inquiry not well documented in the past. Narrower fields include socioeconomic status, gender, ethnicity, cultural traditions, diet, health, and substance abuse.

Recreation resources must possess physical integrity relative to a Period of Significance. Few intact resorts and hotels will appear as they did when initially established, having been occupied for extended periods and modified over time. Such resorts and hotels could represent evolution and changes in operation, tourist preferences, and transportation. Other resorts in the corridor were abandoned and may possess integrity on an archaeological level.

Many of the NRHP aspects of historic integrity apply to resorts, although not all need be present. To retain integrity of *location*, a structure or building should be in a place of functional use at the resort. For a resort complex to retain integrity of *design*, the material remains must convey the complex's planning including grounds, support facilities, and ancillary buildings. Individual buildings retain integrity of design when their period footprint, form, and architectural features are evident. Rural resorts retain *setting* when the surrounding land appears today as during historic occupation. Similarly, hotels in communities retain setting when the streetscape is largely unchanged. In terms of *feeling*, the resource should convey resort recreation from a historical perspective and in the context of land use today. Integrity of *association* exists where structures, buildings, and archaeological features convey a strong connection between the historic resort and a contemporary observer's ability to perceive the activities that occurred at the property.

PROPERTY TYPE: OUTDOOR RECREATION SITE

Outdoor recreation sites are a category of resources that people created when using and enjoying the natural environment. The category only includes those types of clearly identifiable recreation-related resources common in the I-70 corridor. The resources exhibit an emphasis on outdoor activities, purposeful experience with nature, and resultant constructs, land use modifications, and other tangible evidence. Property Subtypes, outlined below, include Fishing Camps, Hunting Camps, Campgrounds, Picnic Grounds, and Trailheads. All but fishing and hunting camps included roads for vehicle access. To describe and evaluate contributing road and trail segments, consult Appendix VI in National Register Bulletin 16A: *How to Complete the National Register Registration Form*. A list of common site features is at the subsection's end, and universal building types, including cabins, are listed in Section B 8.

Some resources such as campgrounds feature clusters of related Property Types. A campground, for example, may include campsites, a pavilion, and trailhead. Cohesive assemblages of resources may qualify as historic districts when contributing elements and

integrity sufficiently convey the Property Types and their significance. If the resource qualifies as a designed landscape, readers may refer to *National Register Bulletin 18: How to Evaluate and Nominate Designed Historic Landscapes* for further guidance on documentation and nomination. Some resources have been impacted within the last fifty years through replacement of materials, buildings, and structures, but this may not preclude eligibility. The resources in entirety, or portions therein, could be eligible if present character-defining attributes date to a Period of Significance and sufficiently convey resource significance. Resources heavily modified within the last fifty years may qualify for nomination under a later Period of Significance as time passes and this context is updated. They can also be evaluated under NRHP Criterion Consideration G, recognizing exceptionally important properties that achieved significance within the last fifty years.

Historic Forest Service buildings are likely in several of the corridor's principal towns, as regional offices exist in Idaho Springs and Dillon. Readers might refer to *Administering the National Forests of Colorado: Assessing the Architectural and Cultural Significance of Historical Administrative Properties* (1996) as a context for type and style of Forest Service administrative buildings. The context is available on-line and through the Forest Service.⁷¹⁰

Outdoor Recreation Property Subtypes

Property Subtype: Fishing Camp: A fishing camp was a temporary base of operations where people camped while fishing, primarily on a recreational basis. Although camps ranged in origin, size, and sophistication, all were in or on the edge of trees near fishable streams and lakes.

When occupied, the smallest and most primitive camps involved one or two wall-tents, a fire ring, activity area, and little else. Anglers often pitched their tents on cut-and-fill earthen platforms featuring baling wire loops at the corners and rocks or logs retaining the fill. The fire ring, a focal point of the camp, was used for cooking, warmth, and entertainment at night. To serve these functions, most rings were 2' to 4' in diameter with high walls of stacked cobbles. Frequently used camps sometimes had rectangular, mortared masonry fireplaces fitted with grills. The activity area, nearby for convenience, was a heavily trampled plot used for food preparation, readying fishing equipment, and chopping wood. Although anglers occasionally provided their own tables, large rocks and downed logs sufficed. An impoundment for storing catch was a distinguishing characteristic of fishing camps. Impoundments were alignments of cobbles and small boulders in a stream or lakeshore nook, which prevented fish from washing away while allowing water to circulate. Because the shore environment is often unstable, most impoundments have been destroyed, leaving only those well constructed of boulders still extant.

Fishing camps maintained by packers, guides, and resort operators tended to offer better facilities for angler comfort. Frame and log cabins were alternatives to wall-tents, with privies providing sanitation. Masonry fireplaces were routinely substituted for crude fire rings, and activity areas featured picnic tables and logs for seating.

Because fishing camps were temporary, seasonal in use, and consisted of impermanent constructs, most are now represented by archaeological features. The tent platforms, fire rings, fireplaces, and activity areas may be overgrown and eroded. The artifact assemblage is important for site identification and interpretation and should include fishing hardware.

⁷¹⁰ Hartley, Ralph and Schneck, James *Administering the National Forests of Colorado: Assessing the Architectural and Cultural Significance of Historical Administrative Properties* Lincoln, NE: U.S. Forest Service, Midwest Archaeological Center, 1996.

Property Subtype: Hunting Camp: Hunting camps were similar in content and configuration to fishing camps, but were distinguished by several differences (see Illustration B 7.1). In location, hunting camps were not restricted to major streams and lakes and instead were established in environments historically favored by game. Hunters chose valleys, meadows, and fringe ecosystems in the mountains, but rarely deep forest or extreme topography. A game rack used to hang quarry was among the defining characteristics of a hunting camp. The typical rack consisted of one or two thin logs nailed at least 5' above the ground between trees. Usually represented by archaeological features, hunting camps can be identified by an artifact assemblage with numerous cartridge casings, dressing hardware, and butchered game bones.

Property Subtype: Campground: Recreational campgrounds existed in the I-70 corridor as early as the 1870s but did not become popular until the 1920s, when automobiles granted tourists autonomy and a means of carrying equipment. Early campgrounds differed in form and content from those designed to accommodate auto tourists. Originally, campgrounds were located in roadless areas because packers used draft animals to bring tourists and their camping equipment to a site. The preferred environment was flat ground at the edge of a clearing, near water, vistas, or interesting natural features. Most early campgrounds identifiable today were used regularly by packers and guides and were even maintained by resort operators. Because campgrounds were center to group excursions, they were fairly well developed with multiple wall-tent platforms, large fire rings or masonry fireplaces, and logs for seating. Campgrounds used by professional packers and guide services may have included a privy, food hutches, cooking hearth, and shelter.

Campgrounds changed in configuration to accommodate auto tourists. Auto-friendly camps, built by the Forest Service and private interests, had to be near a road and provide enough flat land for multiple parties and their automobiles. Typically, a drive led from a main road to the campground, and a circulation road or large open area allowed the tourists to park by individual campsites. On level or gently sloped ground, campsites offered a tent pad, table, masonry fireplace, and food hutch. Centrally located were privies, a wood supply, water, and often an office and pavilion with fire ring.

Federal and state agencies began campground construction programs during the 1930s and continued through the 1960s. Most agency-built campgrounds were professionally planned for aesthetics, privacy, and managing traffic and impact. The types of amenities and facilities were largely the same as previous decades, although water systems and trash service were more common. Campgrounds did change, however, in size and layout. They were larger and had multiple circuits and loops with more campsites. Amenities were well built with natural materials for longevity and an organic appearance. Tables consisted of thick planks, and fireplaces were stone masonry with grills, hinged shrouds, and chimneys. Station buildings and pavilions were also constructed with natural materials, often combining stone, logs, and lumber. Faucets provided running water, and outhouses offered toilets. Small-scale structures changed by the 1970s, increasingly assembled from prefabricated materials or were factory-made such as free-standing fire pans. But in form, campgrounds remained largely the same.

Property Subtype: Picnic Ground: In overall content, small-scale structures, and setting, picnic grounds were similar to campgrounds. Further, many picnic grounds previously were campgrounds redesignated due to maintenance and use issues. The two resource types, as designed for function, can be differentiated by several distinguishing characteristics. First, picnic

grounds usually featured table sites in a perimeter around a parking lot or pull-through drive. Second, the table sites were generally closer together with less privacy than campgrounds. As a result, picnic grounds were smaller and more compact. Third, table sites lacked tent platforms, with the ground around the picnic table and fireplace the only level area. Fourth, primitive picnic grounds often lacked running water and flush toilets. Last, picnic grounds, however small, were often associated with trailheads and fishing areas.

Property Subtype: Trailhead/Trail: Hiking has been a popular recreational activity in the I-70 corridor almost continually since the 1870s. Few trails were purposefully constructed for recreational hiking from this time through around 1900, and tourists generally walked wagon roads, paths along streams, logging trails, and pack trails established by miners. The routes lacked formal trailheads, way markers, or distance and destination signs. Between 1900 and 1920, the Colorado Mountain Club, Forest Service, Denver Mountain Parks, and private groups built recreational trails, adding to a growing system during the next five decades. Some trails were primarily access arteries for early firefighters and timber managers, while others were graded specifically for recreation, starting from a defined trailhead and ending at a destination chosen for natural attributes. En route, trails passed through a variety of topography, scenery, and ecosystems for enjoyment and an intimate experience with the environment.

By the mid-1930s, the Forest Service began publishing standards for transportation and recreational trails, recognized as primary and secondary. In general, tread, the surface walked on, was 24" wide for secondary trails and 30" for primary trails, leveled and incised into slopes, with gradient varying for localized conditions. Vegetation was cleared to arms' length, stumps left in place for soil stability, with minimal rockwork unless absolutely required. For trails ascending steep slopes, the Forest Service recommended switchbacks with 4' diameter segment junctions and, in extremely steep terrain, rock retaining walls and even guardrails. In wet areas, ditches on the tread's upslope side provided drainage, culverts of local rock carried streams under trails, and elevated treads or corduroy afforded solid footing. Blazes cut through tree bark marked trail routes in forest, and posts or rock cairns in meadows and exposed slopes. Signs were spared for intersections and distance points, and ranged in type from painted wood, to wood with incised lettering, to sheet steel with cutout lettering. For greater detail on trails and their bridges, signage, and construction methods, see *Forest Trail Handbook*, published by the Forest Service in 1935 and available on-line.⁷¹¹

Trailheads were in open areas and featured parking, signs, and gateway improvements denoting the trail, usually well beaten. The most popular also offered several picnic tables, trash service, privies, and later vault toilets. Gateway improvements could have been split-rail fences, gates, cairns, and multiple signposts with trail names, destinations, distances, and information panels. Early signs were wood planks with incised figures, those dating from the 1930s through 1950s were sheet steel with cutout or painted lettering, and subsequently factory-painted sheet steel with stickers and reflective tape. Signs, cairns, and blazes on trees served as route markers farther long the trail.

Outdoor Recreation Site Property Type Significance

The fishing and hunting camps, picnic and campgrounds, and trailheads/trails described above were manifestations of the outdoor recreation movement. From the 1870s to present,

⁷¹¹ U.S. Forest Service *Forest Trails Handbook* U.S. Department of Agriculture, U.S. Forest Service, 1935.

tourists came to the I-70 corridor specifically to enjoy the natural environment. They did so for fishing, hunting, camping, and hiking, often combining several of these activities in a single outing or vacation. Popularity of these activities changed over time, with camping and hiking increasing during the 1920s when automobiles became more common. The trend is reflected in type and timeframe of outdoor recreation sites in the corridor. Most date to the 1930s and later, with trails and campgrounds in particular exhibiting evidence of evolution since then. Although small-scale aspects have been removed or replaced within recent decades, many sites retain their original form, design, and configuration.

Outdoor recreation sites reflect several Areas of Significance, including Conservation, Entertainment/Recreation, Landscape Architecture, and Politics/Government. As manifestations of the overall outdoor recreation movement, the Property Subtypes share the same general registration requirements. In general, the Period of Significance 1860 to 1962 covers outdoor recreation as a theme throughout the corridor. But the theme's history was not uniform in geography, and narrower timeframes may be more applicable to specific regions: 1860 to 1962 in Clear Creek drainage, 1878 to 1962 in Summit County, and 1887 to 1962 along the Eagle and Colorado rivers. Level of significance will be local, although some resources may be statewide, depending on further research.

Areas of Significance: Conservation and Politics/Government: Through its dependence on the natural environment, outdoor recreation contributed to the rise of *Conservation* and *Politics/Government* in Colorado. Trails, and picnic and campgrounds, were vehicles that helped public land agencies transition from an emphasis on natural resource production to recreation management. Camping, hiking, and picnicking required large areas of land retaining natural appearance, and fishing and hunting were only viable with clean water, fish, and game. In the I-70 corridor, the U.S. Forest Service owned huge tracts with these qualities, but that agency initially managed the land primarily for industrial uses. Between 1907 and 1920, natural resource extraction declined in influence, while outdoor recreation increased. Hunters and anglers demanded conservation of waterways, fish, game, and a suitable environment. Forest Service policy and culture gradually shifted toward managing land for recreation as much as for other uses. By the 1930s, the Forest Service partnered with other federal and state agencies in promoting outdoor recreation, purposefully planning trails, fishing areas, and picnic and campgrounds. The policy shift continued through the 1950s and 1960s, ultimately resulting in conservation and the National Environmental Protection Act of 1969. Due to a century of use by hunters, anglers, campers, and hikers, the Forest Service now considers recreation the primary use of its land in Colorado.

Area of Significance: Entertainment/Recreation: Outdoor recreation sites were places of enjoyment, relaxation, entertainment, and growth for more than 100 years. People fished, hunted, camped, and hiked to escape their daily routines, urban settings, and stress of modern life. They also developed personal relationships with nature and improved physical fitness. Picnic grounds and the various types of camps were vehicles by which the dominant culture increasingly valued the natural environment. This was particularly ascendant during the nineteenth century, when the dominant culture emphasized recreation either indoors or in controlled outdoor settings. Tourists came to the corridor specifically to enjoy the Rocky Mountain environment, and picnic grounds and the various types of camps provided them with safe and predictable places for an intimate experience. By hiking, picnicking, fishing, and camping, tourists learned to appreciate nature and even developed lifelong appreciation for the outdoors. Over time, thousands of nature-based tourists influenced the dominant culture by disseminating their experiences and changing values.

With the support of organized picnic grounds and camps, outdoor recreation gradually became a cultural norm and even a rite among a growing middle class. By the 1950s, American culture accepted outdoor activities as a mainstream form of recreation.

Area of Significance: Landscape Architecture: In the Area of *Landscape Architecture*, picnic and campgrounds and trail systems represent the adaptation of the natural environment for recreation. Outdoor interests and planners purposefully designed properties to fit within natural features, topography, and ecosystems for an intimate experience with the outdoors. Further, some planners and government agencies considered impacts to the natural environment in their designs, with an interest in preserving the environment for its own sake. These trends differed from urban and industrial planning, where the built environment emphasized functionality with little thought of the natural environment. In general, landscape architecture for outdoor recreation reflects changing cultural values toward conservation and appreciation of nature.

Outdoor Recreation Site Registration Requirements

To qualify for the NRHP, an outdoor recreation site must meet at least one of the Criteria listed below, and possess adequate physical integrity to convey its significance.

Criterion A: Resources eligible under Criterion A must be associated with at least one Area of Significance noted above as well as a contribution to a broad pattern of history.

Criterion B: Recreation sites may be eligible under Criterion B provided an association with the life of an important person significant in our past. Presence will most likely be through residence, caretaking, or regular visits and use. The resource must retain physical integrity relative to that person's productive life. A brief biography is necessary to detail the individual's significant contributions. In some cases, important people were involved with establishing camps but did not occupy the property. Also, important people such as famous cultural figures and leaders vacationed at camps. Such an association does not meet the registration requirements outlined here. The individual of note must have been present on-site for a sustained period of time. In general, Criterion B is complex, and *National Register Bulletin 32: Guidelines for Evaluating and Documenting Properties Associated with Significant Persons* can provide further guidance.

Criterion C: Camps and picnic grounds may be eligible under Criterion C as representative examples. The overall assemblage of buildings, structures, and landscape modifications may also be a sound example of design and land use specific to outdoor recreation. For a site to be eligible, it should possess character-defining features even if only on an archaeological level.

At *fishing and hunting camps*, tent platforms, cabin locations, fire rings and hearths, and activity areas should be discernible. Game racks should be interpretable at hunting camps.

At *campgrounds predating 1920*, tent platforms, fireplaces or rings, seating and activity areas, and other facilities should be evident.

Campgrounds postdating 1920 should feature individual campsites, the drive or pull-through, and support facilities such as privy pits or a pavilion. All campsites need not be identifiable, but a representative sample should be evident.

Picnic grounds should feature table sites, a drive or pull-through, and support facilities such as privy pits or a pavilion. All table sites need not be identifiable, but a representative sample should be evident.

Eligible *trailheads/trails* must offer a parking area, the trail, and gateway improvements. Resources consisting only of a parking area and trail with no improvements or evidence of early development are not eligible under this Property Type.

Outdoor recreation sites may be the product of an architect, planner, or builder. Sites may be eligible as historic recreational landscapes. Similarly, small-scale camps, buildings, and structures may be eligible as contributing elements of a larger district or site.

Criterion D: Buildings, structures, and land use modifications often left archaeological evidence when removed or abandoned. When this evidence clearly represents a camp or picnic ground, then the site retains integrity on an archaeological level. Material evidence should permit the virtual reconstruction of the site and characteristic land use patterns. If archaeological features and artifacts are likely to yield important information regarding camp or picnic ground design and use, then the site may qualify under Criterion D. The property can qualify if its surface artifacts or buried archaeological deposits are capable of addressing important research questions. The demography and behavior of tourists in the outdoors are areas of inquiry not well documented. Narrower fields include socioeconomic status, gender, ethnicity, cultural traditions, diet, health, and substance abuse.

Outdoor recreation sites must possess physical integrity relative to their Period of Significance. Because intact resources have been used for extended periods and modified over time, few will appear as they did when initially established. In such cases, they can represent evolution and changes in recreational activities, traditions, and preferences. Most early fishing and hunting camps, and campgrounds were abandoned and their buildings and structures collapsed or removed. Integrity in these instances may be on an archaeological level. Many picnic and campgrounds are still in use, and are expected to feature a combination of original and replacement features. Integrity requires that most of the original buildings and structures be present. Although still in use, picnic and campgrounds often conform to their original design and layout, retaining integrity of design.

Many of the NRHP aspects of historic integrity apply to outdoor recreation sites, although not all need be present. To retain integrity of *location*, a structure, building, or object should be in a place of functional use at the site. For a site to retain integrity of *design*, the material remains must convey the complex's planning including grounds, support facilities, and land use modifications. Sites retain *setting* when the surrounding land appears today as during its Period of Significance. This requires a preserved natural landscape in most cases. In terms of *feeling*, the resource should convey outdoor recreation from a historical perspective and in the context of land use today. Integrity of *association* exists where structures, buildings, and archaeological features convey a strong connection between the historic site and a contemporary observer's ability to perceive the patterns of recreation or land use that occurred at the property.

TOURISM AND RECREATION SITE FEATURES

Ski Area Feature Types

Ski Area Building Types

Compressor Station – Typical Character-Defining Features

Dry winters with little snowfall presented ski area operators with the problem of a short ski season, and hence reduced income. By the 1970s, well-capitalized outfits solved this by artificially making snow. A compressor pressurized a plumbing system with frigid air, released through special nozzles strategically placed along ski runs. A

trickle of water introduced into the nozzle blasted out under pressure and became snow. The compressor was usually a stationary unit at a compressor station on the mountain. A single building, prefabricated or designed for the purpose, enclosed the machinery.

- Core Plan: Rectangular, open interior.
- Stories: 1
- Foundation: Concrete footers or slab on earthen platform.
- Walls: Frame sided on exterior with planks and corrugated or ribbed sheet iron.
- Roof: Front- or side-gabled with rafters, plank decking and sheet iron. Often sheet iron on rafters for small buildings.
- Entry Door: Usually located in the front, broad, and made of planks or sheet metal.
- Windows: Square or rectangular with fixed frames.

Equipment Shed – Typical Character-Defining Features

Ski area operators constructed buildings throughout a property to store equipment, materials, and large machinery. On the mountain, the buildings tended to be small, simple, and located near ski runs and chairlifts. Stored materials typically included fencing, signs, tools, and snow-making equipment. At the base area, the buildings were larger to accommodate machinery, snowmobiles, parts, and even vehicles. Some buildings were prefabricated, while others were planned in the field by developers and assembled with purchased materials.

- Core Plan: Rectangular, open interior.
- Stories: 1
- Foundation: Timber footers or concrete on earthen platform.
- Walls: Frame sided on exterior with planks, corrugated or ribbed sheet iron, or tarpaper.
- Roof: Front- or side-gabled, or shed, with rafters, plank decking and sheet metal. Often sheet metal on rafters for small buildings.
- Entry Door: Usually located in the front, broad, and made of planks or sheet metal.
- Windows: Square or rectangular with fixed frames.

Lodge – Typical Character-Defining Features

Developers began building lodges at principal ski areas during the 1950s and at all areas by the 1960s. The purpose was to attract greater numbers of skiers, and especially families, by providing indoor amenities and a warm place to wait. The typical lodge, center to the base area, featured a dining hall, waiting area, food service, restrooms, and ticket and administration offices. Usually professionally designed, each lodge was a unique expression of a ski area's available capital, popularity and status, and expectations for future growth. Given this, lodges ranged widely in size, footprint, roofline, and construction. Minor ski areas had small and simple buildings erected at little cost, while prominent areas featured large, complex, and sophisticated versions. Each lodge was also unique in appearance and rarely followed a particular architectural style.

Skier Services Building – Typical Character-Defining Features

Ski areas had buildings for skier services and other functions not housed in the lodge. Ticket and administration offices, ski schools, and ski equipment rentals were built at some base areas. First aid and ski patrol stations could be anywhere in the ski area. Although most buildings were designed by an architect, they were utilitarian in appearance and ranged widely in construction, footprint, and size.

- Core Plan: Rectangular, L-shaped, or complex.
- Stories: 1 or 2
- Foundation: Concrete footers or slab, or cinderblock.
- Walls: Frame sided on exterior with paneling or planks over plywood. Cinderblock walls were common during the 1950s and 1960s.
- Roof: Front- or side-gabled with rafters, plank or plywood decking, and sheet iron or rolled asphalt cladding.
- Entry Door: Usually located in the front, factory-made steel or solid wood composite.
- Windows: Square or rectangular with steel, aluminum, or wood frames.

Warming Hut – Typical Character-Defining Features

Prior to the 1950s, popular ski areas had buildings known as warming huts where skiers could eat, thaw, and wait for others. Warming huts preceded later base areas and were located at the bottom of the most heavily used ski runs. Although some of the buildings could have been designed by architects, most were planned in the field and

constructed by the ski area organizer to fill need at minimal cost. Further, the area organizer used available materials, primarily logs or locally cut lumber. In this sense, most warming huts were vernacular.

- Core Plan: Rectangular, L-shaped, or complex.
- Stories: 1
- Foundation: Cinderblock, or timber or log footers.
- Walls: Frame sided on exterior with planks, or logs.
- Roof: Front- or side-gabled with rafters, plank decking, and sheet iron or rolled asphalt cladding.
- Entry Door: Usually located in the front, factory-made panel or custom-made of planks.
- Windows: Square or rectangular with wood frames, often salvaged from elsewhere.

Ski Area Structures and Archaeological Features

Catwalk: A catwalk was a multipurpose path, usually a road, traversing across a mountainside and its ski runs. In summer, catwalks provided service vehicle access to important portions of the ski area. In winter, skiers used catwalks to move about the mountainside and shortcut or avoid difficult runs.

Chairlift: A chairlift, also known as a ski lift, carried skiers from the bottom to the top of a ski run. Area operators began installing chairlifts during the 1950s to attract greater numbers of skiers, who previously had to walk. The typical apparatus consisted of seats attached to an endless cable loop suspended from a series of towers. The bottom and top terminals had large-diameter sheave wheels for the cable, mounted in heavy frames. Although steel beams were standard by the 1950s, some early frames could have consisted of timbers. Short lifts had one drive-motor at the top terminal while long lifts had motors in both terminals. Originally, both terminals featured control panels in the open, and later in booths.

Chairlift Terminal: A chairlift terminal refers to the top and bottom end-points of a chairlift system. A terminal consists of a sheave wheel in a steel or timber frame, the structure's foundation, drive mechanism, and controls.

Chairlift Tower: A chairlift featured a series of towers supporting the endless cable loop and suspended chairs. A distinguishing characteristic of a lift, a typical tower consisted of a steel pole anchored to a substantial concrete footing. The crown featured a cross-member with idler pulleys for the cable, and telephone and electrical lines.

Light Pole: During the 1960s, some ski areas experimented with night skiing in hopes of extending hours and, hence, income. Powerful lights on tall poles lined ski runs designated for night skiing. Poles were steel or treated wood, crowned with spotlights, and spaced at regular intervals along the edges of a run.

Pipeline: By the 1970s, large ski areas featured compressed air and water plumbing systems for artificial snowmaking. The compressed air system consisted of a main extending from a compressor station up the mountain, and distribution pipes along ski runs. Connections for hoses and snow guns were at regular intervals. The water system featured a pipeline tapping a water source from above, and distribution lines paralleling the compressed air pipes.

Sign: A sign is a small-scale object and distinguishing characteristic of ski areas. Colorful, made of metal or wood, and with colloquial names, they marked ski runs for user navigation,

Ski Run: The most important aspect of an area, a ski run provided a line of descent down the mountain for skiing. Developers cut the runs through forest, clearing logs and stumps, and often using natural topography for variety.

Early runs were narrow, short, and fairly straight but changed during the 1970s. Developers widened runs so greater numbers of skiers could go faster and lengthened them as improvements in lift technology allowed. Developers also thinned, but did not completely clear, swaths of forest for tree runs.

Ski Jump: Ski jumping, popular in the late nineteenth and early twentieth centuries, required ramps at the bottoms of long runs. The ramps consisted of snow piled over an earthen base, possibly retained with logs.

Ski Tow: Predecessor to the chairlift, ski tows dragged skiers from the bottom to the top of a run. In general design, tows consisted of an endless cable loop passing around sheave wheels in top and bottom terminals. Long circuits had poles in between with idler pulleys guiding the cable. Skiers grabbed hold of handles fixed to the cable and were tugged up the slope, although some versions offered sleds. In tows built in the 1930s and 1940s, structural elements were assembled from logs and timbers, and salvaged automobile engines provided power. Afterward, steel was used for structural elements, motors provided power, and skiers squatted over a bar fixed to the cable.

Resort Feature Types

Resort Building Types

Hotel and Resort Building – Typical Character-Defining Features

The character-defining features applicable to hotels and principal resort buildings are covered in the section on Architecture. Large, custom-designed resort buildings are difficult to classify according to a common building typology because of their uniqueness. Each should be considered individually.

Cabin – Typical Character-Defining Features

Resorts and campgrounds often had cabins for tourists interested in private, indoor accommodations. Cabin form and construction varied, and a typology can be found in the section on High- Altitude Agriculture.

Carriage House – Typical Character-Defining Features

Until the 1920s, carriage houses were used for storage of carriages, buggies, tack hardware, parts, and supplies. Afterward, many were converted to garages. Occasionally, the buildings included resort staff quarters at the rear or in a loft above. In form, most buildings were rectangular, one to one-and-one-half stories high, covered by a front- or side-gabled roof, with open interior. The core plan was often modified with an enclosed shed-roofed storeroom at rear or on one side. Large carriage houses were L-shaped in footprint with a second story. Trim may have imparted stylistic elements compatible with the hotel or resort building.

- Core Plan: Rectangular or L-shaped
- Stories: 1 to 2
- Foundation: Some foundations were log or timber posts, or footers laid on an earthen platform. Others were made of coursed stone, later with concrete pargeting, or poured concrete.
- Walls: Horizontal planks, horizontal weatherboard, or board-and-batten siding over wood sheathing 2"x4" or 2"x6" framing.
- Roof: Front- or side-gabled, often covered with wood or asphalt shingles, or rolled asphalt over plank decking fastened to lumber rafters. Large carriage houses may have featured hipped roofs.
- Chimney: Brick chimney or stovepipe for forge, usually at one end of the building.
- Entry Door: Main entries are primarily barn doors, custom-made of planks, centered in the front. Secondary panel doors may be in the side or rear.
- Windows: Vertically oriented sash windows, often with 1/1 or 2/2 glazing patterns, in milled lumber frames.

Garage – Typical Character-Defining Features

A garage was a building for storage of automobiles, fuel, parts, and supplies. Early garages, pre-dating 1930, may have doubled as carriage houses. Occasionally, the buildings included resort staff quarters at the rear or in a loft above. In form, most buildings were rectangular, 20' wide for two vehicles, one to one and one-half stories high, covered by a front- or side-gabled roof, with open interior. Large garages were L-shaped in footprint with a second story.

- Core Plan: Rectangular, square, or L-shaped
- Stories: 1 to 2
- Foundation: Some foundations were footers laid on an earthen platform. Others were made of concrete pargeting, poured concrete, or cinderblocks.
- Walls: Horizontal planks, horizontal weatherboard, or rolled asphalt siding over plank sheathing and 2"x4" or 2"x6" framing.
- Roof: Front- or side-gabled, often covered with asphalt shingles, or rolled asphalt over 1x plank decking fastened to lumber rafters. Large garages may have featured hipped roofs.
- Chimney: Brick chimney or stovepipe for forge, usually at one end of the building.
- Entry Door: Main entries are primarily barn doors, custom-made of planks, centered in the front. Secondary panel doors may be in the side or rear.
- Windows: Vertically oriented sash windows, often with 1/1 or 2/2 glazing patterns, in milled lumber frames.

Stable – Typical Character-Defining Features

A stable was a building for horses, draft animals, tack, and feed. In form, most buildings were square or rectangular, one story high, covered by a front- or side-gabled roof, with interior divided into stalls. Tack and hardware may have been stored in a separate room, and feed in a loft. Trim may have imparted stylistic elements compatible with the hotel or resort building.

- Core Plan: Rectangular or square
- Stories: 1
- Foundation: Most foundations were log or timber posts, or footers laid on an earthen platform. Others were made of coursed stone.

- Walls: Horizontal planks, horizontal weatherboard, or board-and-batten siding over plank sheathing and 2"x4" or 2"x6" framing.
- Roof: Front- or side-gabled, often covered with wood or asphalt shingles, or rolled asphalt over plank decking fastened to lumber rafters.
- Entry Door: Main entries are 3' to 4' wide and custom-made of planks. Secondary plank doors may be in the side or rear.
- Windows: Vertically oriented sash windows in milled lumber frames. Also, open windows, no panes, with wood shutters.

Resort Structures and Archaeological Features

The category includes structures, constructs, and archaeological features more likely found at resorts than other Property Types. The features described below under Outdoor Recreation Sites also may be encountered at resorts and should be reviewed.

Carriage House Foundation/Platform: Carriage houses stood on leveled earthen platforms similar in footprint to the building's plan. The platform may feature the timber, concrete, or masonry foundation footings that supported the building, and in such cases, should be recorded as a foundation. Discolored soil or vegetation patterns may outline the building's footprint, and the artifact assemblage will include draft animal hardware or vehicle parts.

Cistern: Resorts often had indoor plumbing pressurized by a water source somewhere upslope. Cisterns were the most common containment, and were large, rectangular tanks countersunk into the ground. Construction ranged from tongue-and-groove planks to concrete to stone masonry. An outlet pipe introduced water, and a drain drew it away.

Cistern Ruin: The collapsed, rubble-filled depression remaining from a cistern.

Garden: Gardens usually encircled the main resort building and featured orderly arrangements of indigenous and non-native species, beds outlined with cobbles, open areas, and walkways. In abandoned gardens, native vegetation is likely but may follow historic planting patterns. Vestiges of introduced plantings are probably apparent and frequently include iris, rose, dogwood, and fruit trees. Remnants of decorative elements such as gazebos, ponds, and bird baths may be present.

Gazebo: Gazebos were small, freestanding structures in gardens, at vantage points, and near streams and lakes. They featured elevated plank floors, roofs supported by lathed columns, and railing around the perimeter.

Gazebo Remnant: The structural ruins of a gazebo.

Hotel Foundation/Platform: Because of their size and weight, most hotels stood on foundations of rock or brick masonry. A cellar and evidence of plumbing may be present. The foundation was usually built on a large earthen platform, which often had two or more terraces when on a slope. The artifact assemblage will likely include a high proportion of ornate domestic hardware, glass, and tableware.

Picnic Area: Picnic areas existed on resort grounds and may include picnic tables and benches, shelters, water pumps, and fire hearths.

Pond: Constructed ponds existed in hotel gardens and on or adjacent to nearby streams. An excavated pond is shallow and typically features a low dam and berms of backdirt.

Pool: Hot springs resorts featured pools for bathing, both indoors and outdoors. Pools range in size, are usually rectangular, 2' to 6' deep, and rock masonry or concrete in construction. An inlet channel or pipe is at the shallow end, an overflow outlet at the deep end, and a drain at bottom.

Pool Remnant: When abandoned, pool walls and rim typically crumble, leaving a depression filled with earth and rubble approximating the pool footprint.

Refuse Dump: At isolated resorts, hotel staff tended to throw refuse away from and behind the building. Over time, they created a concentrated deposit of general domestic rubbish, broken bottles, food cans, and tableware. Dumps can be important for their archaeological potential.

Stable Platform: Stables stood on leveled earthen platforms similar in footprint to the building's plan. Post holes and linear berms within the platform may outline stalls. Discolored, loose, and highly organic soil or vegetation patterns may outline the building's footprint, and the artifact assemblage will include draft animal hardware.

Walkway: Walkways were designed to direct foot traffic between important points at a resort and its grounds. Some were packed earth or sod, and many were flagstone, cobble, brick, or concrete.

Outdoor Recreation Site Feature Types

Bench: Benches are common to resort, picnic, and campgrounds, and trailheads. Heavy plank seats were fastened to stone masonry or angled timber legs. Concrete and steel were common by the 1960s.

Cabin Platform: Cabins usually stood on earthen platforms graded with cut-and-fill methods. Foundation footers and a high proportion of structural materials may distinguish a platform as that for a cabin instead of a wall-tent. Because cabins were universal residential buildings, their association may be difficult to interpret without material evidence. Characteristic artifacts, location by a major stream or lake, or presence of a game rack, may confirm a cabin as that for fishing or hunting.

Cabin Ruin: Some frequently used hunting and fishing camps had cabins for lodging instead of tents. After abandonment, they often collapsed and became ruins.

Dam: Often, recreation interests raised the water level of ponds and lakes with dams to improve fish habitat. The dams, constructed with earth and rock rubble, were low and spanned the natural outflow channel. Rarely were they professionally engineered.

Dock: Ponds and lakes featured docks for fishing and mooring recreational skiffs. The docks were vernacular designs built as needed. The structure consisted of plank decking nailed to timber stringers supported by log pilings.

Fence: Fences delineated boundaries around picnic and campgrounds, marked trailheads, and defined corrals at hunting camps and resorts. They usually consisted of natural materials for economy and aesthetics. Split rail, post, and buck-and-rail types were most common.

Fence Ruin: The collapsed remnants of a fence.

Fire Pan: Fire pans were factory-made, freestanding steel boxes for fires. Common at campground and picnic grounds by the 1970s.

Fireplaces: Fireplaces were popular for outdoor cooking, heating, and entertainment at resorts, camps, and picnic grounds. They ranged in size from 3'x4' to 4'x6' in area, were several feet high, with grills and hinged shrouds. Construction was mortared local stone.

Fire Ring: Fire rings served the same purposes as fireplaces and were common at primitive camps and picnic areas. They were circular, 2' to 4' in diameter, of stacked cobbles. By the 1960s, welded steel grates with skirts, often hinged over concrete pads, became common.

Food Hutch: To prevent wildlife from consuming food, picnic and campgrounds often featured plank lockers with hinged doors. Most stood on plank legs.

Game Racks: Hunting camps featured racks for hanging game above the ground. Most racks were several thin logs nailed between stout trees.

Hunting Blind: Hunters constructed barricades with natural materials for concealment while waiting for game. Blinds, still in use today, were usually tangled or stacked branches in a strategic location. Historic blinds will be partially collapsed and consist of highly weathered material.

Parking Area: Auto-friendly recreation sites required parking areas, ranging from open ground to avenues defined by fences and drives.

Pavilion: Pavilions were common for group activities at resorts and picnic and campgrounds. They consisted of a roof supported by four or more posts. The roof consisted of wood or asphalt shingles, rolled asphalt, or corrugated sheet-iron nailed to planks supported by lumber or log rafters. The posts may have been lumber, logs, or stone masonry. One side may have been defined by a wall, and the interior often featured benches or tables.

Picnic Table: Picnic tables are common to resorts, picnic and campgrounds, and trailheads. Heavy planks served for bench seats and tabletops and were fastened to stone masonry or angled timber legs. Concrete and steel were common by the 1960s.

Privy: A building that served as a toilet facility. Privies stood over pits, were around 4'x8' in area, and featured a bench with cutouts as toilet seats.

Privy Ruin: The collapsed remnants of a privy building, often overlying a pit.

Privy Pit: Prior to indoor plumbing, hotel guests and staff relied on privies for personal use. When the pit became full, the building was moved and the pit capped with soil and rocks. Over time, the pit subsided into a depression. Domestic refuse, a berm of backdirt, and evidence of the privy foundation may remain.

Refuse Scatter: A refuse scatter is a disbursed, largely surficial deposit of domestic rubbish. Scatters are often common behind buildings and around camps and picnic areas.

Shelter: A shelter was a vernacular structure that provided temporary protection from the elements. In picnic and campgrounds, shelters may have been small versions of pavilions, with one or more open sides. They were rarely designed by architects and were built for the need with available materials. Trails and primitive camps featured crude shelters assembled from logs or stacked rocks, with roofs of branches, lumber, or sheet iron.

Shelter Ruin: Due to poor construction, most early shelters collapsed and are now in ruins.

Tent Platform: Most camps, regardless of era, featured leveled earthen pads for tents. At early camps, the platforms were usually graded with cut-and-fill methods and had rocks or a log retaining the fill material. Baling wire loops for guy lines may exist at the corners.

Trail: A trail was a well-beaten footpath for hiking or accessing outdoor recreation sites. Abandoned trails may be overgrown but defined by a concave tread, terrace across a slope, or dirt walkway flanked by cobbles.

Trail Marker: Trails were marked by a variety of constructs and objects, including cairns, signs, log posts, and blazes cut into tree trunks.

Trash Receptacle: By the 1930s, recreational sites featured cans for refuse, usually chained to a timber post.

Water Fountain: From the 1890s through 1950s, well-developed outdoor sites, especially resort, picnic, and campgrounds featured fountains for drinking water. They ranged in construction from stone masonry pylons to free-standing porcelain basins.

Water Pump: Early picnic and campgrounds had hand-operated pumps for drinking water, either free-standing or in stone masonry pylons.

Water Spigot: A water spigot provided water for general use at picnic and campgrounds. It consisted of a faucet in a stone masonry pylon or on a pipe tied to a pole.

Section B 8: Universal Architectural Property Types and Registration Requirements

The I-70 corridor includes numerous communities and towns. Most of those between Idaho Springs and Vail Pass began as mining centers, while others, farther west from Vail Pass to Glenwood Springs, had origins in agriculture or railroads. Over time, the communities adapted to changing economies, transportation systems, and broad social movements, especially outdoor recreation, tourism, and automobile travel. All of the communities are rich with architectural resources representing these and other broad trends, as well as local histories and cultural preferences.

Section B 8 focuses on the principal, universal types of historic buildings in the corridor's towns and unincorporated communities. When evaluating the significance of a building, researchers can consider it individually, as well as within the broader community. Although detailed histories of each community are not provided in this document, their general trends and patterns can be extracted from the themes in Section A. The communities, with their numerous buildings and extant populations, require additional research and context.

Three broad architectural Property Types are developed in this section: Domestic Residential Buildings, Commercial Buildings, and Cultural/Religious/Public Related Buildings. Within each category, the buildings are further classified by subtypes according to function, form, style, and materials, including both those known to exist, and those considered likely. For buildings specific to themes presented in Section A, see the end of each subsection for listing.

Architectural terminology adheres closely to the online lexicon *Colorado's Historic Architecture and Engineering – Field Guide*⁷¹² and its companion *Colorado's Historic Architecture and Engineering – Web Guide*.⁷¹³ Recognizing that scholarship regarding Colorado's historic architecture is not static, the online format allows for the introduction of newly-developed architectural styles, forms and materials, and adaptation of existing ones. The *Guide* was published online in 2008, a third edition of *A Guide to Colorado Architecture*, written by Sarah J. Pearce and published by the Colorado Historical Society in 1983. One reference useful to researchers is the *Guidance on Vernacular Building Forms* added to the Office of Archaeology and Historic Preservation's lexicon in 2010. The reference will be further developed in the future.

The following Property Types and Subtypes are developed in this section:

- Domestic Residential Buildings
 - Pioneer Log Cabin
 - Wood Frame Dwelling
 - A-Frame Dwelling
 - Greek Revival Style Dwelling
 - Second-Empire Style Dwelling
 - Italianate Style Dwelling

⁷¹² "Field Guide to Colorado's Historic Architecture and Engineering." <http://www.historycolorado.org/archaeologists/colorados-historic-architecture-engineering-field-guide>.

⁷¹³ "Field Guide to Colorado's Historic Architecture and Engineering." <http://www.historycolorado.org/oahp/colorados-historic-architecture-engineering-web-guide>.

- Queen Ann Style Dwelling
- Edwardian Style Dwelling
- Dutch Colonial Style Dwelling
- Craftsman Style Dwelling
- Rustic Style Dwelling
- Outbuilding (including barns, carriage houses, garages, privies, and woodsheds)
- Commercial Buildings
 - False-Front Commercial Building
 - Nineteenth Century Commercial Building
 - Early Twentieth Century Commercial Building
 - Automobile-Related Commercial Building
- Cultural, Religious, and Public Buildings
 - Cultural/Social Building
 - Government/Administrative Building
 - Church

PROPERTY TYPE: DOMESTIC RESIDENTIAL BUILDINGS

Domestic Residential Buildings are dwellings where individuals and families attended to domestic duties and personal business. Subtypes include Single-Family Dwellings (houses), Multiple-Family Dwellings (with more than one set of quarters such as duplexes, apartments, and boardinghouses), and Outbuildings. Following the *Field Guide's* format, the architecture of dwellings is based on nomenclature of materials, forms, types, and styles. Some early dwellings are identified by their primary building material (e.g. pioneer log); others by form or basic shape and roof type (e.g. gabled-L plan); still others by recognized architectural types and styles. The list below covers common, universal types.

Domestic Residential Building Subtypes

Property Subtype: Single-Family Dwelling: This property subtype is the most prevalent architectural resource type in I-70 corridor towns. Dwellings may range in age from a settlement's founding to present time, reflecting a correspondingly wide range of architectural materials, forms and styles.

Pioneer Log Cabin: The earliest dwellings in I-70 corridor towns were small pioneer log cabins (Illustration B 8.1), followed by progressively more elaborate houses of wood frame construction.⁷¹⁴ Constructed primarily from local materials, pioneer log cabins featured horizontal log walls, typically with square, saddle, V-notched, or dovetailed corner joints. The logs were either round or hewn square. In addition to their basic building material (log), these cabins are more specifically categorized by an architectural terminology pertaining to their core shape or plan, roof type, door and window placement, number of rooms, and ancillary features such as porches. Log cabins were usually rectangular in shape, with a gable roof, and containing either a single room (single-pen cabin, Illustration B 8.2) or two rooms (double-pen cabin). Some cabins, though, featured a more elaborate L-shaped or T-shaped plan covered by a cross-gable roof. These are termed Gabled-L and Gabled-T types. Rectangular-shaped double-pen cabins

⁷¹⁴ Pioneer Log should not be confused with Rustic Style, defined below.

may be subcategorized as Shotgun or Hall-and-Parlor plan. A Shotgun dwelling featured a basic rectangular plan one room wide, and in the case of a double-pen cabin, two rooms deep. It was covered by a front-gable roof, with the entry door in the gable end. There were no interior hallways, and the two rooms were divided by a log wall with an interior doorway. Hall-and-Parlor plan was also rectangular, but covered by a side-gable roof, with entry door on the side elevation beneath the eave. Hall-and-Parlor cabins contained two rooms, with one larger than the other. The entry door led into the larger of the two, which served as general living space and the kitchen, with the smaller primarily a bedroom. Gabled-L and Gabled-T cabins were typically larger, and usually 1½-stories with enough room in the upper half story to serve as sleeping quarters. Refer to the end of Section B 3, High Altitude Agriculture for typical character-defining features of the following pioneer log cabins:

- Single-Pen
- Double-Pen
- Shotgun
- Hall-and-Parlor Plan
- Gabled-L Plan
- Gabled-T Plan

Wood Frame Dwelling: Early wood frame dwellings followed an evolutionary pattern progressing from a basic one-story rectangular box to 1½-story Gabled-L and Gabled-T forms, and eventually to regionally or nationally identifiable forms, including the I-House, Foursquare, Bungalow, Hipped-Roof Box, Classic Cottage, and A-Frame. Architect-designed frame dwellings often exhibited traditional influences and construction techniques passed down through generations, brought west and adapted to Colorado's mountain towns. The houses were also heavily influenced by the needs and visions of their owners through economic factors and by dissemination of popular building materials, techniques, stylistic influences and architectural details. In the I-70 corridor, community growth heavily influenced the transition from logs to lumber as construction materials. Efficient transportation and the presence of sawmills made commercial lumber available in a community. Lumber being a preferred material, houses were predominantly built of wood frame construction afterward. The houses also gradually began displaying stylistic influences and ornamental details reflecting the builder's individual tastes and traditions, and increasingly, architectural fashions then in vogue. The nationwide diffusion of architectural pattern books and magazines also influenced ornamental details, architectural style, and building form. By the late 1890s, house plans and ornamentation became available through Sears, Roebuck & Company, *House Beautiful*, and *Ladies Home Journal*. Around the same time, architectural publications such as the *Craftsman*, *Western Architect* and *Architectural Record*, began promoting and distributing plans for specific types of houses, notably the Craftsman Bungalow. The influence of such publications, and the availability of manufactured materials, manifested in ornamental details such as porch rails, columns, brackets, and other decorative elements applied to existing dwellings, while new houses tended to reflect the latest architectural trends and styles. In the I-70 corridor, however, houses continued to reflect vernacular and traditional influences well into the twentieth century. Refer to the end of Section B 3, High Altitude Agriculture for a list of the character-defining features for the following wood frame dwellings common in the corridor:

- Rectangular Plan Wood Frame Dwelling
- Shotgun House Wood Frame Dwelling
- Hall-and-Parlor House Wood Frame Dwelling
- I-House Wood Frame Dwelling
- Gabled-L Plan Wood Frame Dwelling
- Gabled-T Plan Wood Frame Dwelling
- Hipped-Roof Box Wood Frame Dwelling
- Pyramid Cottage Wood Frame Dwelling
- Foursquare Dwelling
- Classic Cottage Dwelling
- Bungalow Dwelling

A-Frame Dwelling: Easily recognizable from their A-shaped form, A-Frame buildings became popular in Colorado's mountain communities in the 1960s (See Illustration B 8.3). Although often residences, A-Frames were also constructed as commercial buildings, serving as fast-food restaurants, motels, or small retail establishments. A-Frame buildings are defined by a steeply-pitched gable roof, with the roof eaves extending to grade and doubling as walls on two side elevations. Taking maximum advantage of limited space, A-Frames featured simple and open interior plans, with living, dining, and kitchen facilities on a ground-level, and a sleeping loft above. Dormer windows were occasionally used to illuminate the loft areas. The following character-defining features are typical:

- Core Plan: Rectangular footprint; A-shaped profile.
- Stories: 1 or 1½.
- Foundation: Poured concrete or concrete block, with no basement level.
- Roof/Walls: Steeply-pitched front-gabled roofs, with roof eaves extending to grade and forming the side elevations.
- Dormer: Small dormers illuminating a sleeping loft appear on some examples.
- Entry Door: Horizontal sliding glass bypass doors appear on many examples. They admitted ample light and did not require interior space for swinging open.
- Windows: Predominantly fixed-pane, horizontal sliding, or casement type windows, often with triangular-shaped fixed-pane windows in the upper gable ends.
- Porch: Open wood decks are a common feature associated with A-Frame dwellings.

Single-Family Dwelling Architectural Styles: Following is a list of frame dwellings exhibiting characteristics of defined architectural styles. They are presented chronologically, beginning with the earliest stylistically influenced dwellings built during initial settlement periods, and continuing to architectural styles popular at present.

Greek Revival Style Dwelling: Dating from circa 1860 to the mid-1870s, Greek Revival style dwellings are rare in Colorado (See Illustration B 8.4). Examples exist within the I-70 corridor, primarily in the mining towns of Idaho Springs, Georgetown, and Silver Plume. Character-defining features include:

- Modest size and scale.
- Wood frame construction.
- Pedimented wood lintels and architraves over and surrounding doors and windows.
- Pilasters at the corners, often fluted, and particularly on the façade.
- Engaged piers.
- Transom and sidelights surrounding the primary entry.

- Slim, refined, Tuscan or Doric porch columns.
- Double-hung sash windows with multiple panes in both the upper and lower sashes.
- Front-gable or side gable roof, or less often a hipped roof.

Second-Empire Style Dwelling: Dating in Colorado from circa 1860 to 1880, this style is also known as French Second-Empire from its origins in French Renaissance traditions (See Illustration B 8.5). A Mansard roof, often with concave sides and dormer windows, is a key distinguishing feature of Second-Empire style. Although modest examples may exist, most Second-Empire residences are high-style buildings. Apart from its Mansard roof, this style has many features in common with the Italianate style built around the same time period. Character-defining features of Second-Empire style residences include:

- Mansard roof, with concave or straight sides, and often with dormer windows.
- A projecting bay or tower extending above the roof line.
- Pedimented windows, often with molded surrounds.
- Quoining at the corners, particularly on the façade.
- Roof cresting.
- Bracketed cornices.

Italianate Style Dwelling: Dating in Colorado from circa 1870 to 1900, Italianate style houses are primarily defined by low-pitched hipped roofs and widely-overhanging eaves with paired decorative brackets (See Illustrations B 8.6 and B 8.7). Lack of a Mansard roof differentiates Italianate style from Second-Empire style, which otherwise share many common features. Character-defining features of the Italianate style include:

- Low-pitched hipped roof with widely-overhanging eaves.
- Cornice with decorative paired brackets.
- Tall, narrow, double-hung sash windows, with rounded or segmental arches and molded surrounds.
- High style examples may also feature a cupola or tower, arcaded porches, quoins, roof cresting, and ornate detailing especially in association with the front porch and primary entrance.

Queen Anne Style Dwelling: Dating in Colorado from circa 1875 to 1910, Queen Anne houses represent the most ornate style from the late Victorian era (See Illustrations B 8.8). Queen Anne residences exhibit a vertical orientation, with asymmetrical massing, multiple roof forms and pitches, and contrasting wall materials including the use of both brick and wood. Relatively modest, as well as richly-decorative high-style examples, exist within the I-70 corridor. Character-defining features include:

- Vertical orientation.
- Asymmetrical massing.
- Steeply-pitched roofs, with multiple intersecting forms and pitches.
- Dormers.
- Contrasting wall materials, often including both brick and wood.
- Use of contrasting colors.
- Corner towers or turrets, often with conical roofs.
- Prominent bay windows, often with bracketed cornices.
- Prominent, richly-decorative, porches, with turned columns, porch railings with turned balusters and, spindle friezes.
- Sunburst motifs over entry doors and in upper gable ends.
- Gable ornaments.

- Bargeboard.
- Decorative shingles.

Edwardian Style Dwelling: Edwardian style houses in Colorado represent a blend of late Victorian era styles, notably Queen Anne, and revival styles of the late nineteenth century and early twentieth century (See Illustrations B 8.9). They were most commonly built between circa 1900 and 1920. The form and massing of Edwardian style homes are similar to Queen Anne houses, but are not as richly decorated, often featuring Colonial and Classical detail elements. Character-defining features include:

- Predominantly brick construction.
- Most often 2 or 2½ stories.
- Asymmetrical massing.
- Cross gabled roofs or hipped roofs with intersecting gables.
- Wraparound porches.
- Colonial or Classical details.

Dutch Colonial Revival Style Dwelling: Dutch Colonial Revival style houses in Colorado were constructed between circa 1900 and 1925 (See Illustration B 8.10). They are primarily defined by a steeply-pitched gambrel roof, with the main entry on the side or end elevation. Character-defining features include:

- Steeply-pitched gambrel roof, with widely-overhanging eaves.
- Dormers.
- Prominent porches, often with Tuscan or Doric columns.
- Colonial or Classical details.
- Prominent fireplace chimneys.
- Double-hung sash windows, often with 6-over-6 or 8-over-8 glazing patterns.

Craftsman Style Dwelling: As discussed above under Bungalow type houses, the Craftsman style was inspired by the Arts and Crafts movement in America, beginning in the late nineteenth century (See Illustrations B 8.11 and B 8.12). While Bungalows represent the most prolific house type inspired by the Arts and Crafts movement, components of the Craftsman style were employed on a variety of residential building forms, including both Single-Family homes and small apartment buildings. Character-defining features of Craftsman style residences include:

- Brick or wood frame construction.
- Widely overhanging eaves with exposed rafter ends.
- Clipped gables.
- False half-timbering.
- Decorative purlins and ridgepoles with knee braces.
- Battered porch pedestals and large, often tapered, columns.
- Double-hung sash windows, with multiple (ribbon style) windows in the upper sashes.

Rustic Style Dwelling: Rustic style architecture is characterized by its natural setting and prevalence of log and stone for building materials (See Illustrations B 8.13). Designed to blend in with their natural setting, Rustic style buildings emphasized traditional building techniques and materials. The National Park Service and U.S. Forest Service embraced the style during the 1910s, with private architects and builders subsequently adopting it. The style reached a zenith

during the 1930s, popularized by its use in Civilian Conservation Corps and Depression era Works Progress Administration projects. In Colorado, early examples appear in mountainous areas in and adjacent to national forests. The style was also used at dude ranches, tourist-related facilities, and limited numbers of houses. Character-defining features include:

- Log walls; often stained natural brown manufactured horizontal half-log siding.
- Stone foundation, or a concrete foundation faced with stone.
- Battered lower walls.
- Stone chimneys.
- Small window panes.
- Widely-overhanging eaves, often with stained natural brown exposed rafter ends.
- Use of stone and log in porch floors, walls, and support elements.

Property Subtype: Multiple-Family Dwelling: This property subtype refers to multi-unit residences home to more than one household. Specific types of Multiple-Family dwellings include duplexes, apartment buildings, boardinghouses, and company housing. Boardinghouses provided basic, inexpensive lodging mostly to single men, and hence were colloquially known as bachelor halls. Often located in transitional areas between commercial, industrial, and residential neighborhoods, boardinghouses were typically two or two-and-a-half story buildings. Common architectural forms were Foursquare, Gabled-L, and Gabled-T plans, and styles included Italianate, Colonial Revival and Edwardian. Multiple dwellings, in a variety of forms and styles, were common during the Great Depression as families combined and accepted boarders to supplement income. A number of formerly large single-family homes were converted into apartments during the 1930s, with most remaining multiple dwellings from that time forward.

Property Subtype: Outbuilding: A variety of outbuildings were directly associated with residences in the I-70 corridor. These ancillary buildings reflect changing lifestyles and technologies from the 1870s well into the twentieth century. In function, early outbuildings often supported basic domestic needs and self-sufficiency. Common types included carriage houses, small barns, chicken coops, coal or woodsheds, well houses, and privies. Due to technological advances such as indoor plumbing, and the availability of goods from nearby stores, the need for outbuildings gradually decreased during the 1910s. Moreover, with society's increased dependence on automobiles, garages eventually replaced barns and carriage houses as the most prevalent outbuilding type.

Function, available materials and financial resources, and the builder's preferences influenced outbuilding form, construction and appearance. Outbuildings featured basic rectangular plans and were usually of wood frame construction, although some were built of logs or masonry. Substantial outbuildings stood on low stone or poured concrete foundations, while temporary versions were simply built on wood footers. Poured concrete began replacing masonry as a common foundation material during the early 1900s.

Domestic Residential Building Significance

Domestic residential buildings were associated with and participated in a variety of important trends. These are summarized as the Areas of Significance: Architecture, Community Planning and Development, and Exploration/Settlement. Significance is usually at the local level. The Period of Significance applicable to the I-70 corridor in entirety spans 1859 to 1962. But residential development did not occur simultaneously throughout the corridor, and instead varied in time by corridor segment. Thus, narrower timeframes are: Clear Creek drainage 1859-1962, Blue River valley 1878-1962, and the Eagle and Colorado River valley 1870-1962. The themes discussed in Section A provide more detail.

Area of Significance: Architecture: Types, styles, materials, and construction methods reflect local, regional, and national trends, socioeconomic changes, and advances in technology. They also represent traditions, cultural preferences, and the effect of transportation and industry. For example, architectural styles and ornamental detail elements were influenced by the nationwide diffusion of architectural pattern books and magazines. The railroad provided a ready supply of milled lumber and manufactured building materials for new styles and ornamentations. Indoor plumbing, the automobile, and other technological advancements impacted the styles and sizes of homes. Lot sizes, how buildings were situated relative to each other, and placement relative to streets were also impacted. Architecturally significant domestic buildings are a good representative example of a type, period or method of construction. They also may be the work of a master builder or architect.

Area of Significance: Community Planning and Development: Residential buildings directly reflect how communities in the I-70 corridor were planned and developed. Town founders filed plats and sold lots with the intent that different areas would see residential, commercial, or industrial development. They often also planned for public buildings such as courthouses, town halls, and schools, in specific areas. The built environment of each community correspondingly manifests the plats and planning efforts of the town's founders.

Area of Significance: Exploration/Settlement: The Area of *Exploration/Settlement* applies to buildings dating between 1859 and 1880 in Clear Creek drainage, 1878 through 1885 in the Dillon and Frisco area, and 1875 through 1892 in the Eagle and Colorado river valley. During these periods, architecture directly supported and was a product of the central Rocky Mountain frontier. Residences were among the earliest buildings erected on the frontier, both in new communities and in remote locations. In some cases, residences influenced settlement patterns, becoming seeds for later communities and industry. Residences also supported the frontier movement by housing individuals who made the frontier possible.

Domestic Residential Buildings Registration Requirements

To qualify for the NRHP, Domestic Residential Buildings must meet at least one of the Criteria listed below, and possess sufficient physical integrity to convey the Property Type and its significance.

Criterion A: Domestic residential buildings eligible under Criterion A must be associated with at least one Area of Significance above, or important historic events or patterns in their communities.

Criterion B: Domestic residential buildings may be eligible under Criterion B provided a direct association with the life of an important person significant in our past. A building registered under Criterion B must also retain its physical integrity relative to that person's productive life. A brief biography is necessary to detail the individual's significant contributions. In some cases, significant people initially developed or owned properties, but did not physically occupy the property. Such an association does not meet the requirements for Criterion B. The important individual must have been present in the building. Applying Criterion B is complex, and *National Register Bulletin 32: Guidelines for Evaluating and Documenting Properties Associated with Significant Persons* can provide further guidance.

Criterion C: Domestic residential buildings may be eligible under Criterion C if they are good representative examples of a type, period, style, or method of construction. Similarly, a building may be eligible under Criterion C if it represents the work of a master builder or architect, or if it possesses high artistic values.

Criterion D: Buildings, structures, and land use modifications often left archaeological evidence when removed or abandoned. A building lot may possess a standing dwelling, as well as archaeological features representing property developments, improvements, or domestic activities. Such evidence may convey patterns of domestic residential settlement and community development during a Period of Significance. If archaeological features and artifacts are likely to yield important information regarding settlement patterns, property development and design, or domestic life, then the property may qualify under Criterion D.

If the property possesses building foundations, privy pits, and refuse dumps, testing and excavation of these buried archaeological deposits may reveal important information regarding lifestyle and demography within individual communities. Areas of inquiry may include but are not limited to diet, health, gender and family, ethnicity and cultural practices, socioeconomic status, mode of employment.

Domestic residential buildings must possess physical integrity relative to the Areas and Periods of Significance outlined in Section A. Intact buildings retain integrity when the period, appearance, design, and form are clearly evident. Few residential buildings, however, appear precisely as they did when initially constructed. Instead, many were modified over time as their residents adapted to changing technologies, socioeconomic trends, values, and preferences. Such modifications may not preclude eligibility if the building clearly reflects its continued use. Contributing archaeological features retain integrity when material evidence conveys building locations, design of the residential complex, and aspects of the residents and their lifestyles. All

seven aspects of historic integrity as defined by the NRHP may apply to domestic residential buildings, although not all need be present for eligibility.

Location: Location is the place where a historic dwelling was constructed, and where associated events and trends occurred. A dwelling must be in its original place of use to retain integrity of location.

Design: Design is the combination of elements conveying form, plan, space, structure, and style of a property. Design results from decisions made during the original conception and planning of a property (or its significant alteration) and applies to activities as diverse as community planning, architecture, and landscape architecture. Design elements include organization of space, proportion, scale, technology, ornamentation, and materials. A property's design reflects historic functions and technologies, as well as aesthetics. It includes considerations such as the structural system; massing; arrangement of spaces; pattern of fenestration; textures and colors of surface materials; type, amount, and style of ornamental detailing; and arrangement and type of plantings in a designed landscape.

Design can also apply to districts, whether they are important for historic association, architectural value, information potential, or a combination thereof. In districts, design applies to the way in which buildings, sites, or structures are related. Examples include spatial relationships between major features; visual patterns in a streetscape or landscape plantings; the layout and materials of walkways and roads; and the relationship of other features such as statues, water fountains, and archeological sites.

Setting: Setting is the physical environment around a historic dwelling, with both natural and manmade elements. A dwelling retains integrity of setting when the character of the place, the surrounding features and open spaces, and functional boundaries appear as they did during the Period of Significance.

Materials: Materials are the physical elements that were assembled or deposited in a particular pattern or configuration to form a historic property. The choice and combination of materials reveal the preferences of those who built the dwelling and indicate availability of particular materials and technologies. Local materials are often the focus of regional building traditions and thereby help define an area's sense of time and place. To retain integrity of materials, a dwelling must feature the key exterior elements dating from its Period of Significance.

Workmanship: Workmanship can apply to a dwelling as a whole or its individual components. Integrity of workmanship involves the physical evidence of craft, method, labor, and skill in constructing or altering a building. It can be expressed in vernacular methods of construction or ornamental detailing. Common traditions, innovative period techniques, technological practices, and aesthetic principles may be reflected in the workmanship of a dwelling.

Feeling: Feeling is a dwelling's expression of the aesthetic or historic sense of a Period of Significance. Integrity of feeling requires the presence of physical features that, taken together, convey the property's historic character.

Association: Association is the direct link between an important historic event or person and a historic property. A dwelling retains association if it is the place where the event or activity occurred and is sufficiently intact to convey that relationship to an observer. Like feeling, association requires the presence of physical features that convey a dwelling's historic character.

PROPERTY TYPE: COMMERCIAL BUILDINGS

Commercial buildings in the I-70 corridor have been constructed from the beginning of settlement to present day. The architectural characteristics, size, scale, and placement of commercial buildings follow discernible trends. Within each town, commercial buildings were primarily concentrated along a broad main street, and located on deep, narrow, lots designed to maximize storefronts along a block face. Twenty-five feet was the most common width for a commercial lot, with large buildings expected to span multiple lots. Constructed progressively of wood, stone, and brick, commercial buildings were most often one or two stories in height. They typically fronted directly onto wide board or sidewalks, and with the side walls of adjacent buildings abutting each other. Some stand-alone commercial buildings deviated from this pattern when automobiles became common. These buildings were usually associated with single retail uses, embraced new architectural trends, and were often set well back from the sidewalk to accommodate off-street parking.

The property subtypes and architectural styles discussed below are intended to comport with relevant sections of the *Field Guide to Colorado's Historic Architecture and Engineering* available online through the OAHIP website. Presented chronologically, the property subtypes and styles include: False-front Commercial Buildings; Late Nineteenth Century Commercial Buildings (including single storefronts, double storefronts, corner buildings, and commercial blocks); Twentieth Century Commercial Buildings; Automobile-Related Commercial Buildings including motels, motor courts, filling stations, automobile dealerships, and automobile repair garages.

Commercial Buildings Subtypes:

Property Subtype: False-Front Commercial Building: False-front commercial buildings are an easily-recognized symbol of Colorado's pioneer heritage (See Illustration B 8.14). Constructed in mining, agricultural, and railroad- communities throughout the I-70 corridor, false-front commercial buildings predate 1900. Examples from as late as the 1940s are, however, possible. One to two stories in height, these buildings are typically of wood frame construction, conforming to a front-gabled rectangular form. The front façade, more substantial in lumber and construction than the other walls, extends upward to conceal most if not all the roof. Front façade walls were also typically finished with horizontal wood siding, a decorative bracketed cornice, and the name or nature of the business in decorative lettering. In general, the façade was intended to suggest a stable and successful business, while a commercial block lined with false-front buildings helped create an illusion of a substantial, prosperous town. Character-defining features include:

- Front-gable roof.
- Façade parapet extending above the roof line.
- Wood frame construction (log examples may exist).

- One to two stories.
- Elaborate cornice, often with decorative brackets.
- Rectangular or L-shaped plan.

Property Subtype: Nineteenth Century Commercial Building: Commercial buildings in the I-70 corridor, constructed between 1865 and 1900, may be categorized as single storefronts, double storefronts, corner buildings, and commercial blocks (See Illustrations B 8.15 - B 8.18). The businesses historically located in these buildings catered to the retail needs of the towns' citizens during the latter half of the nineteenth century. Common trades included general stores, bakeries, meat markets, saloons, restaurants, confectioneries, dry goods, millineries, and pharmacies. Most towns also featured one or more banks, livery stables, and saddlery shops near their commercial cores.

Single storefronts were typically 25' across, the width of a commercial lot, with a single, centered, entry. Double storefronts were typically 50' across, spanning two commercial lots, and with separate entrances for two adjacent businesses. Two-story versions had a third doorway leading to an interior staircase. Corner buildings often had angled corner entries designed to attract pedestrian traffic from intersecting streets. Commercial blocks were larger, spanning multiple lots, were and were usually two or more stories in height.

Retail stores occupied the street level of nineteenth century commercial buildings, while second stories housed hotel rooms, professional offices, or meeting space for fraternal organizations. Early examples were of wood frame construction, and one or two stories in height, while examples in principal towns were of brick or stone masonry. Roofs could have been front-gabled, sloping gently rearward, or sometimes flat, allowing for a broad façade.

Many buildings featured prefabricated cast iron elements such as kickplates, simulated columns, and cornices with parapets, recessed panels, and finials. A secondary cornice often separated the first and second stories, replicating the primary cornice at the top of the façade wall. Some cast iron façades were fabricated by regional ironworks companies, while others were shipped from manufacturers in the east. At the street level, the façade featured recessed entrances with transom lights over the entry door, flanked by fixed-pane storefront display windows. Second story windows were comparatively smaller, and were typically narrow double-hung sash type units surrounded by segmental or rounded brick arches, or flat sandstone lintels. Character-defining features buildings include:

- Four basic plans: single storefront, double storefront, corner building, commercial block.
- Kickplates.
- Recessed entrances with transom lights over the primary entry door.
- Fixed-pane storefront display windows.
- Smaller, narrow, double-hung sash second story windows with segmental or rounded brick arches, or flat sandstone lintels.
- Flat or rear sloping roofs.
- Cast iron facades, variously with simulated columns, and decorative cornices with parapets, recessed panels, and finials.
- Secondary cornices between first and second stories.

Early Twentieth Century Commercial Building: Commercial buildings in the I-70 corridor dating from the early twentieth century tend to be less ornate than their nineteenth century counterparts (See Illustrations B 8.19 and B 8.20) and often built of brick masonry. Commercial buildings during the early 1900s continued featuring rectangular plans with front-gabled, flat, or

rear-sloping roofs, and were one to three stories in height. The ground-floor housed retail establishments, while higher stories served as office and meeting space, and increasingly as small apartments. Decorative elements were often limited to corbelled brickwork and recessed brick panels along the upper façade wall. Some entry doors were flush with the façade wall, while others were deeply recessed or incorporated into angled first story façade walls. Second-story windows typically featured flat lintels. Character-defining features include:

- Brick masonry or wood frame construction.
- Flush, recessed, or angled entries.
- Translucent window transoms.
- Transom lights over entry doors and fixed-pane storefront display windows.
- Decorative brickwork, including corbelled cornices and recessed brick panels.
- Flat or rear-sloping roofs.
- Less ornamentation than late nineteenth century commercial buildings.

Property Subtype: Automobile-Related Commercial Building: Widespread adoption of automobiles during the 1920s brought change to commercial architecture and patterns of community development. Although traditional businesses continued operating in previously described Main Street commercial buildings, entrepreneurs introduced new building types conducive to automobiles and auto travel. To present day, corridor towns increasingly saw construction of motels, motor courts, filling stations, automobile repair garages and dealerships, and new and larger restaurants and stores. The buildings, either modified versions of traditional architecture or entirely new in appearance, materialized on the edges of town, where land was inexpensive and plentiful. Entrepreneurs realized they needed space for traffic and parking, and could intercept travelers entering or leaving town. When developing auto-friendly property, architects and owners broke from tradition and moved buildings away from the street, to provide convenient parking. Due in part to changing tastes and culture, and to catch attention from passing motorists, businesses began advertising with colorful signage, neon lighting, and buildings with unique, oddly-shaped roofs. Below is a list of the common commercial buildings closely associated with automobile travel.

Service Station: Service stations, also known as filling and gas stations, were essential facilities in support of automobile travel. At a minimum, they sold fuel to automobile owners, and many also had garages offering basic repair and servicing. Three station types existed in the I-70 corridor: the Cottage Service Station, House-with-Canopy station, and Oblong Box station.

Primarily dating from the 1910s and 1920s, House-with-Canopy gas stations are among the earliest automobile-specific buildings (See Illustration B 8.21). They were located at intersections and along well-traveled roads for convenience to drivers. The basic plan featured a small square or rectangular office, with a low-pitched hip or gable roof extending over a poured concrete pull-through driveway where fuel pumps were located. Some examples featured two canopy roof extensions forming an L-shaped plan over intersecting driveways. Defining characteristics are:

- Small square or rectangular plan office.
- Low-pitched roof, with canopy extending over pull-through driveway.
- Canopy supported by center-post, or twin posts at the ends.
- Multi-paned windows.
- Located at intersections or along well traveled roads.

Cottage station buildings were erected by oil companies primarily in the 1920s (See Illustration B 8.22). They featured English-Norman Cottage or modest Tudor-Revival stylistic elements, and were designed to blend in with residential neighborhoods.

- Small square or rectangular plan office.
- Steeply-pitched side-gabled roof, with closed eaves or minimal overhang.
- Steeply-pitched gable over entrance.
- Multi-paned windows.
- Located at intersections or along well traveled roads.

As the number of automobiles increased during the 1920s, filling station operators began offering repair services in addition to fuel. Most contemporary station buildings were not designed for this, requiring operators to locate service bays behind or beside the office. Grease pits, short ramps, or crank lifts provided mechanics with access to the underside of vehicles. The expansion into vehicle repair and maintenance began a shift in gas station form and function from filling station to service station, with buildings increasingly incorporating attached garages and bays into initial design.

In the 1930s, oil company executives and their architectural designers embraced new concepts in industrial design. To enhance the presentation of products and services, they gave consideration to a service station building's overall shape, interior layout, company logos and symbols, color, texture, sounds, and displays. One result was the Oblong Box type service station, commonly built through the 1970s (See Illustrations B 8.23 and B 8.24). Architecturally, these buildings embraced Art Deco, Streamline Moderne, and Industrial style elements. Most stations featured basic rectangular, flat-roofed plans, but some examples were built with butterfly, shed, gable, and neo-Mansard roof forms. Interior space was divided into a small sales room/office, a storeroom at rear, and one or two service bays to one side. The service bays had metal or wood-paneled rollaway doors, and lifts to raise and service autos. Men's and women's restrooms were usually located in the rear corner of the building behind the sales/office area, entered through doors in the rear of the side elevation. In some designs, however, the women's restroom was accessed from within the sales room for security. In the 1970s, Oblong Box service stations gave way to the convenience store type station, which dominates at present. Many Oblong Box station buildings remain in the I-70 corridor, either for autos or other retail uses.

- Rectangular plan
- Most commonly with a flat roof
- Minimalist streamlined decorative elements
- Corner sales room/office
- One or two service bays
- Men's and women's restrooms

Auto Courts, Motor Courts and Motels: Accommodations for automobile travelers, known as auto courts, motor courts and motels, were built in the I-70 corridor from the 1920s through 1960s (See Illustrations B 8.33 and B 8.34). Earlier auto courts typically consisted of a series of small detached cottages serving as motel units, arranged around or behind a detached office building, with living space for the owner/operator. In later versions, the motel units were located side-by-side in a single building, typically with a rectangular, L-shaped, or U-shaped plan. Such plans created a courtyard area providing parking, garden for picnicking, and by the 1960s, an

outdoor pool. Most complexes also featured an attractive sign, often with neon lighting, designed to capture the attention of automobile travelers. Some complexes also featured a roadside entryway, such as stone pillars spanned by an arched sign. Auto courts, motor courts, and motels were typically one-story buildings of wood frame construction, although some were built of concrete blocks. Exterior wall surfaces were often stuccoed or clad with horizontal or vertical wood siding, or wood shingle siding. Roofs were typically gabled, flat, or, less often, hipped. Most complexes were not built in a particular architectural style, although some affected architectural themes such as Rustic style with a veneer of stained half log siding. Other stylistic variants may exist. A parking place directly outside each motel unit's door was a key feature of all such complexes. The interior layout was basic, with a rectangular-plan room, space for one or two beds, a dresser, a writing table, and perhaps an armchair. Bathrooms were typically located at the rear of each unit. A front window overlooked the parking lot, while a smaller frosted glass window in the bathroom overlooked the rear of the motel property. By the early-to-mid 1960s, locally owned auto courts, motor courts, and motels began giving way to national chains, with unified architectural themes and signage, such as Holiday Inn and Best Western.

- Rectangular, L-shaped or U-shaped plans, or detached cottages
- Central courtyard /parking
- Office building with living quarters for the motel owner/operator
- Prominent signage, and occasionally an entryway near the roadway
- One-story, typically of wood frame or concrete block construction; later examples may be two stories
- Adjacent parking for each motel unit

Automobile Repair Garages: By the 1910s, automobiles and trucks were numerous enough in the corridor to support repair garages in the largest towns, and by the 1920s, smaller communities as well. Initially, garages were attached to, or integral with, filling stations as noted above (See Illustrations B 8.35 and B 8.36). Increasingly, they were stand-alone buildings operated by independent businesses, or combined with automobile dealerships, typically located on the fringes of downtown commercial districts. Garages most commonly featured rectangular plans, and were primarily built of wood frame, brick masonry, or concrete blocks. In some cases, the concrete blocks were impressed with decorative patterns or stone texturing. Building facades often featured stepped brick parapets, corbelled brickwork, or a decorative brick cornice. Roofs ranged from flat, to gabled, to barrel form. Other common features included service bay entries, industrial sash windows, and a brick chimney. Service bay entries dating from the 1910s through 1950s had double doors or bi-fold units, wood-panel or of diagonal plank in construction, often with a row of small windows. Door frames could have been steel or lumber with ornamental brickwork across the top. A smaller wood-panel door in a lumber frame provided street access for customers. During the 1940s, service bays increasingly had overhead or roll-away doors of wood, metal, or fiberglass panels. Smaller entries for staff and customers were also increasingly metal in steel frames. Garages associated with dealerships featured fixed-pane storefront display windows on the facade, while windows on the secondary elevations were industrial sash. The interior was typically divided into the service bay area with one or more grease pits or automobile hoists, an office, service counter, and small waiting room near the front.

- Rectangular plan
- Built as stand-alone facilities or in association with automobile dealerships
- Located on the fringes of downtown commercial districts
- Stepped brick parapets, corbelled brickwork, or a decorative brick cornice on the facade

- Flat, barrel, and gabled roof forms
- Service garage bay doors
- Industrial sash windows
- Storefront display windows if part of an automobile dealership

Commercial Building Significance

Commercial buildings in the I-70 corridor were associated with and participated in a variety of important trends. These are summarized below as Areas of Significance Architecture, Commerce, Community Planning and Development, and Exploration/Settlement. Level of significance is local. The Period of Significance applicable to the overall I-70 corridor spans 1859 to 1962, with commercial development an important movement during this entire timeframe. But the important periods of commercial development varied slightly for each community, which had its own history and economy. The Periods of Significance by drainage, are: 1859-1962 in Clear Creek, 1878-1962 in Blue River and Ten Mile Canyon, and 1870-1962 along the Eagle and Colorado rivers.

Area of Significance: Architecture: Commercial buildings are architecturally significant because they represent the materials, forms, and styles of the buildings where goods and services were bought and sold. The above qualities reflect local, regional, and national trends, socioeconomic changes, and advances in technology. They also represent traditions, cultural preferences, values, community development, and the effect of transportation and industry. For example, the railroad provided early developers with manufactured building materials for new styles and ornamentations. Widespread adoption of automobiles contributed to changes in preferred location in town, as well as on a property parcel. Other forms of technology including indoor plumbing, electric lighting, and central heat also influenced styles and sizes of commercial buildings. Architecturally significant commercial buildings may display the distinctive characteristics of a type, period or method of construction, or high artistic value. They also may be the work of a master builder or architect.

Area of Significance: Commerce: Commercial buildings may be significant in the Area of Commerce as places where most goods and services were bought and sold, and where people worked, shopped, and conducted other forms of business. Given this, nearly all commercial buildings were directly associated with broad patterns of commerce in the corridor.

Area of Significance: Community Planning and Development: Commercial buildings directly reflect how communities in the I-70 mountain corridor were planned and developed. Town founders filed plats and sold lots on the premise that different areas would see residential, industrial, and public uses. Further, they planned for commercial buildings and even business districts in specific areas. As a result, the early built environment of each town correspondingly manifests the plats and planning efforts of the town's founders. Automobile-related commercial buildings, erected during the twentieth century, reflect community evolution away from historic central business districts and toward businesses scattered along highways.

Area of Significance: Exploration/Settlement: The Area of *Exploration/Settlement* applies to buildings dating between 1859 and 1880 in Clear Creek drainage, 1878 through 1885 in the

Dillon and Frisco area, and 1875 through 1892 in the Eagle and Colorado river valley. During these periods, architecture directly supported and was a product of the central Rocky Mountain frontier. Commercial establishments, especially false-fronts, were among the earliest buildings erected on the frontier, both in new communities and in remote locations. In some cases, successful commercial influenced settlement patterns, becoming seeds for later communities, circulation systems, and industry. Businesses within supported the frontier movement by providing goods and services required for life on the frontier.

Commercial Building Registration Requirements

To qualify for the NRHP, Commercial Buildings must meet at least one of the Criteria listed below, and possess sufficient physical integrity to convey Property Type and significance.

Criterion A: Commercial buildings eligible under Criterion A must be associated with at least one Area of Significance above, and important events or historic patterns in their communities.

Criterion B: Commercial buildings may be eligible under Criterion B when directly associated with the life of an important person significant to our past. A building registered under Criterion B must also retain its physical integrity relative to that person's productive life. A brief biography is necessary to detail the individual's significant contributions. In some cases, significant people initially developed or owned properties, but did not physically occupy the property. Such an association does not meet the requirements for Criterion B. Applying Criterion B is complex, and *National Register Bulletin 32: Guidelines for Evaluating and Documenting Properties Associated with Significant Persons* can provide further guidance.

Criterion C: Commercial buildings may be eligible under Criterion C when they are good representative examples of a type, period, style, or method of construction. Similarly, a commercial building may be eligible under Criterion C if it represents the work of a master builder or architect, or if it possesses high artistic values.

Criterion D: Buildings, structures, and land use modifications often left archaeological evidence when removed or abandoned. A building lot may possess a commercial enterprise, as well as archaeological features representing past property developments, improvements, or uses. Outbuilding foundations or cellars are examples. Such evidence may convey patterns of commercial and community development during a Period of Significance. If archaeological features and artifacts are likely to yield important information regarding settlement patterns, property development and design, and business practices, then the property may qualify under Criterion D.

If the property possesses building foundations, privy pits, and refuse dumps, testing and excavation of these buried archaeological deposits may reveal important information regarding lifestyle and demography within individual communities. Areas of inquiry may include but are not limited to diet, health, gender and family, ethnicity and cultural practices, socioeconomic status, mode of employment.

Commercial buildings must possess physical integrity relative to an Area and Period of Significance outlined in Section A. Intact buildings retain integrity when the period, appearance, design, and form are clearly evident. Few commercial buildings appear precisely as they did

when initially established. Instead, many were modified over time to suit new businesses and changing technological and socioeconomic trends, values, and preferences. Such modifications may not preclude eligibility if the building clearly reflects continued use. Contributing archaeological features retain integrity when material evidence conveys past building locations, property development, and aspects of the residents and their lifestyles. All seven aspects of historic integrity as defined by the NRHP are relevant to commercial buildings, although not all need be present.

Location: Location is the physical place where a historic commercial building was constructed, and where events associated with its businesses, retail functions, and other occupants occurred. A commercial building must be in its original place of construction and use to retain integrity of location. Location is important for understanding the history of the building, its commercial businesses, and associated events and persons.

Design: Design is the combination of elements conveying form, plan, space, structure, and style. Design results from decisions made during the original conception and planning of the building and its related features (or their significant alteration). It also applies to the building's relationship to community planning and landscape architecture. Design elements include organization of space, proportion, scale, technology, ornamentation, and materials. A commercial building's design reflects its historic functions and technologies, as well as aesthetics. A commercial building's structural system, massing, arrangement of spaces, pattern of fenestration, textures and colors of surface materials, and type, amount, and style of ornamental detailing are all elements of design. Other considerations include setback from a sidewalk or curb, number of stories, and proximity to adjacent buildings.

Design can also apply to districts, whether they are important for historic association, architectural value, information potential, or a combination thereof. In districts, design applies to the way in which buildings, sites, or structures are related. Examples include spatial relationships between major features; visual patterns in a streetscape or landscape plantings; the layout and materials of walkways and roads; and the relationship of other features such as statues, water fountains, and archeological sites.

Setting: Setting is the physical environment around a historic building, including both natural and manmade elements. A commercial building retains integrity of setting when the character of the place, the surrounding features and open spaces, and relationship to nearby buildings appear as they did during the Period of Significance. Further, setting should convey the business-related functions a building served.

Materials: Materials are the physical elements that were assembled or deposited in a particular pattern or configuration to form a historic property. The choice and combination of materials reveal the preferences of those who constructed the building and indicate availability of particular materials and technologies. Local materials are often the focus of regional building traditions and thereby help define an area's sense of time and place. To retain integrity of materials, a commercial building must feature the key exterior elements dating from its Period of Significance.

Workmanship: Workmanship can apply to a commercial building as a whole or to its individual components. Workmanship is the physical evidence of craft, method, labor, and skill in constructing or altering a building. It can be expressed in vernacular methods of construction or ornamental detailing. Common traditions, innovative period techniques, technological practices, and aesthetic principles may be reflected in the workmanship of a commercial building.

Feeling: Feeling is a commercial building's expression of the aesthetic or historic sense of a particular Period of Significance. Integrity of feeling requires the presence of physical features that, taken together, convey the building's historic character.

Association: Association is the direct link between an important event or person and a historic property. A commercial building retains integrity of association if it is the place where the event or activity occurred and is sufficiently intact to convey that relationship to an observer. Association requires physical features that convey a building's historic character.

PROPERTY TYPE: CULTURAL, RELIGIOUS, AND PUBLIC BUILDINGS

Buildings under this property type served, or were associated with, governmental, social, or religious functions. Specific kinds of resources include courthouses in Georgetown and Eagle, town halls, libraries, schools, fire stations, post offices, jails, fraternal halls, and churches. Because these resource types served community functions, they are likely to be relatively few in number but architecturally significant. Architectural types and styles as defined in the *Guide* may be present within the corridor. For organizational purposes, resources within this subsection are categorized by function.

Cultural, Religious and Public Building Subtypes:

Property Subtype: Cultural/Social Building: Resources within this subtype primarily served social functions and institutions in a community. The most common properties include fraternal halls, schools, and libraries, along with resources such as playgrounds, picnic shelters, public monuments and works of art.

Fraternal Organization Building: Fraternal organizations, such as the Freemasons, International Order of Odd Fellows, Knights of Columbus, and Woodmen of the World, played an important role in the social fabric of communities within the I-70 corridor. Initially, members rented upstairs rooms in commercial buildings for regular meetings. Some organizations, however, saved enough capital to erect their own buildings, usually commercial in type, meeting on second or third floors while leasing ground floors to businesses. Office space may have been leased as well. In architectural form, type, and style, the meeting halls were similar to commercial buildings, discussed above.

School: Most of the corridor's towns had at least one school building for education, and most are recognizable and can be considered individually. Although schools were primarily used for education, they also served as community centers, meeting places for various organizations, and polling stations during elections. Typical small, early schoolhouses, exemplified by those in

Frisco and Lawson, tend to be rectangular-shaped wood frame buildings with one or two rooms. The type most often has a moderately-pitched front-gable roof, symmetrically-arranged double-hung windows along the two side elevations, and an entry door in the gable end. Many schools also featured a bell tower above the entry, or centered on the roof, as a notable architectural feature. Exterior walls are typically clad with horizontal wood siding. The interior is most often divided into two rooms, the largest a classroom, and the smaller, at the back, living quarters for the teacher. In the classroom, the teacher's desk was at the front, a chalkboard was typically affixed to the wall behind, and student desks were arranged in evenly-spaced rows in the main space. Some schools exhibit characteristics of architectural style, such as an Italianate school in Georgetown, and a Romanesque Revival style school in Silver Plume (see Illustrations B 8.25 and B 8.26). The Georgetown school's prominent Italianate features include a low-pitched hipped roof with paired brackets beneath the eaves. The Silver Plume School's most notable Romanesque Revival feature is its rounded arch windows and doorways.

Library: Libraries are few and can be considered individually. Within the I-70 corridor, libraries range in form and style from Bungalow or Craftsman (see dwellings above), to the Renaissance Revival style Carnegie Library in Idaho Springs. As community nodes, were sources of reading material, further education, entertainment, and polling.

Property Subtype: Government/Administrative Building: As the name implies, the subtype includes buildings erected specifically for government and its functions. Resources include courthouses, town halls, local government office buildings, post offices, fire stations, jails, and other law enforcement-related buildings.

Courthouse: Courthouses are few, one in each county, and can be considered individually. The buildings were key government and administration centers, housing city and county offices administering to finance and budget, records-keeping, land use, and by the 1930s, social services. Courthouses also were judicial buildings with courtrooms, judge chambers, and jails for local legal matters.

Town Hall: Buildings that historically served as town halls are located in communities throughout the corridor. Many occupied late nineteenth century, false-front, or early twentieth century commercial buildings, described above (see Illustration B 8.27). Important community nodes, town halls provided space for public meetings, performances, hearings, displays, and gatherings.

Jail: Jails are few and can be considered individually. Nineteenth century jails, typically of heavy stone construction, are extant in Georgetown, Silver Plume, and possibly other towns (see Illustration B 8.28). Jails were important for law and order, being facilities where crime convicts served local punishment sentences.

Post Office: Post offices were vital communication nodes where the Post Office Department delivered mail, parcels, and even freight from points across the nation, distributing the material among community residents. Historic and modern post office buildings exist throughout the corridor, representing various building forms, types, and styles. Each may be considered

individually, such as the 1882 Frisco Post Office, a 2½-story wood frame front-gabled building listed on the National Register of Historic Places.

Firehouse: Historic firehouses, including some with distinctive hose towers, represent a notable Property Type in Idaho Springs, Georgetown, Silver Plume, and perhaps other communities. Known historically as Hook and Ladder Companies and Hose Companies, firehouses had firefighting equipment at the ready, sometimes with crew on-hand, with occasional use as town halls. Firehouses are few in number and can be evaluated individually. (See Illustrations B 8.29 and B 8.30).

Property Subtype: Church: Representing several denominations, churches are the dominant religious buildings within the corridor. When assessing individual eligibility of churches and other religious buildings, they should be evaluated under NRHP Criteria A-D, as well as Criteria Consideration A.

Architecturally, most churches embody Gothic-Revival and Carpenter-Gothic styles, although some may exhibit Mission Revival style (see *Guide*). Many also manifest as rectangular plan, wood frame front-gable buildings. Gothic-Revival style churches are primarily defined by pointed arch windows. Predominantly of stone or brick masonry construction, Gothic-Revival churches are also likely to feature prominent corner towers, steeply-pitched roofs, buttresses, and deeply-recessed entrances. Towers are typically square, with flat or spired roofs, often enclosing a vestibule. Some examples have twin towers flanking the front entry, while others have a single tower at one corner.

Carpenter-Gothic churches are simple, wood frame buildings that include elements commonly associated with Gothic-Revival style (See Illustrations B 8.31 and B 8.32). Other Carpenter-Gothic features include a rectangular plan, a steeply-pitched roof, clapboard siding, and decorative vergeboard in the façade's upper gable end. Many Carpenter-Gothic churches also feature a bell tower. Character-defining features include:

- Pointed arch windows.
- Decorative vergeboard.
- Clapboard siding.
- Rectangular plan.
- Steeply-pitched gable roof.
- Wood frame construction.

Mission Revival style churches may exist within the I-70 corridor. Primarily defined by curvilinear-shaped gables or parapets, Mission style buildings typically featured smooth stucco or plaster exterior walls, clay tile roofs, and rounded arch doors and windows. Inspired by Spanish missions built in California, Mission Revival style became popular during the early 1900s, especially after the Santa Fe and Southern Pacific Railroads adopted the style for its depots and hotels. Character-defining features include:

- Curvilinear-shaped gables and parapets.
- Tile roof.
- Rounded arches over door and window openings.
- Stucco or plaster exterior wall finish.

Cultural, Religious and Public Building Significance

Buildings used for cultural, religious, and public functions may be significant for a number of reasons. Relevant Areas of Significance include Architecture, Community Planning and Development, Education, and Politics/Government. Level of significance will be local, although some resources could be statewide depending on further research. The general Period of Significance applicable to the I-70 corridor spans 1860 to 1962, but buildings were important after construction.

Area of Significance: Architecture: Resources within the Property Type are architecturally significant because they were, and some still are, prominent community icons. Further, some buildings express values of time period, culture, or community, as well as changing demographics, social patterns, technologies, and transportation.

Area of Significance: Community Planning and Development: Cultural, Religious and Public buildings reflect how I-70 corridor communities were planned and developed. Town founders filed plats and sold lots with the intent that different areas would see residential, commercial, or industrial development. They often also planned for the construction of public buildings such as courthouses, town halls, and schools, in specific areas. As a result, the early built environment of each town correspondingly manifests the plats and planning efforts of the town's founders.

Area of Significance: Education: Schools and libraries played important roles in education. Children in the I-70 corridor received their basic education and developed social patterns in schools, while both children and adults received further education in libraries. These institutions not only helped people learn to read and write, but introduced them to new concepts, cultures, and places outside of their communities.

Area of Significance: Politics/Government: Courthouses, town halls, jails, post offices, fire stations, and other community buildings within the corridor may possess significance relative to politics and government. These buildings facilitated and supported a variety of civic, legal, and administrative functions necessary for order, law enforcement, community development, and democratic form of government.

Cultural, Religious and Public Buildings Registration Requirements

To qualify for the NRHP, buildings under the Property Type must meet at least one of the Criteria listed below, and possess sufficient physical integrity to convey type and significance.

Criterion A: Cultural, Religious, and Public buildings eligible under Criterion A must be associated with at least one Area of Significance above, or important historic events or patterns in their communities.

Criterion B: Cultural, religious, and public buildings may be eligible under Criterion B when directly associated with the life of an important person significant to our past. A building registered under Criterion B must also retain its physical integrity relative to that person's productive life. A brief biography is necessary to detail the individual's significant contributions.

In some cases, significant people initially developed or owned properties, but did not physically occupy the property. Such an association does not meet the requirements for Criterion B. The important individual must have been present in the building. Applying Criterion B is complex, and *National Register Bulletin 32: Guidelines for Evaluating and Documenting Properties Associated with Significant Persons* can provide further guidance.

Criterion C: Cultural, Religious and Public buildings may be eligible under Criterion C if they are good representative examples of a type, period, style, or method of construction. Similarly, they may be eligible under Criterion C if they represent the work of a master builder or architect, or possess high artistic values.

Criterion D: Buildings, structures, and land use modifications often left archaeological evidence when removed or abandoned. A property may possess a standing building in combination with archaeological features representing other development, improvements, or activities. Such evidence may convey patterns of community development and public functions during the Period of Significance. If archaeological features and artifacts are likely to yield important information regarding development and design of public property and the community, then the property may qualify under Criterion D.

If the property possesses building foundations, privy pits, and refuse dumps, testing and excavation of these buried archaeological deposits may reveal important information regarding lifestyle and demography within individual communities. Areas of inquiry may include but are not limited to diet, health, gender and family, ethnicity and cultural practices, socioeconomic status, mode of employment.

Cultural, Religious, and Public buildings must possess physical integrity relative to both an Area and a Period of Significance outlined in Section A. Intact buildings retain integrity when the period, appearance, design, and form are clearly evident. Many were modified over time as occupants adapted to changing technologies, socioeconomic trends, values, and preferences. Such modifications may not preclude eligibility if the building clearly reflects continued use. Contributing archaeological features retain integrity when material evidence conveys past building locations, design of the greater property, and aspects of occupants and building function. All seven aspects of historic integrity as defined by the NRHP may apply to Cultural, Religious, and Public buildings, although not all need be present for eligibility.

Location: Location is the place where a building was constructed, and where associated events and patterns manifested. A building must be in its original place of use to retain integrity of location.

Design: Design is the combination of elements conveying form, plan, space, structure, and style of a property. Design results from decisions made during the conception and planning of a property (or its significant alteration) and applies to activities as diverse as community development, architecture, and landscape architecture. Design elements include organization of space, proportion, scale, technology, ornamentation, and materials. A property's design reflects historic functions and technologies, as well as aesthetics. It includes considerations such as the structural system; massing; arrangement of spaces; pattern of fenestration; textures and colors of surface materials; type, amount, and style of ornamental detailing; and arrangement and type of plantings in a designed landscape. Design can also apply to districts, whether they are important

for historic association, architectural value, information potential, or a combination thereof. In districts, design applies to the way in which buildings, sites, or structures are related. Examples include spatial relationships between major features; visual patterns in a streetscape or landscape plantings; the layout and materials of walkways and roads; and the relationship of other features such as statues, water fountains, and archeological sites.

Setting: Setting is the physical environment around a historic building, including both natural and manmade elements. A building retains integrity of setting when the character of the place, the surrounding features and open spaces, and functional boundaries appear as they did during the Period of Significance.

Materials: Materials are the physical elements that were assembled or deposited in a particular pattern or configuration to form a historic property. The choice and combination of materials reveal the preferences of those who constructed the building and indicate availability of particular materials and technologies. Local materials, forms, and styles are often the focus of regional building traditions and thereby help define an area's sense of time and place. To retain integrity of materials, a building must feature the key exterior elements dating from its Period of Significance. If the property has been rehabilitated in the recent past, then the historic materials and significant features must have been preserved.

Workmanship: Workmanship can apply to a building as a whole or its individual components. Integrity of workmanship involves the physical evidence of craft, method, labor, and skill in constructing or altering a building. It can be expressed in vernacular construction or ornamental detailing. Common traditions, innovative period techniques, technological practices, and aesthetic principles may be reflected in workmanship.

Feeling: Feeling is a building's expression of the aesthetic or historic sense of a Period of Significance. Integrity of feeling requires the presence of physical features that, taken together, convey the property's historic character.

Association: Association is the direct link between an important historic event or person and a historic property. A building retains association if it is the place where the event or activity occurred and is sufficiently intact to convey that relationship to an observer. Like feeling, association requires the presence of physical features that convey a building's historic character.



SECTION C: GEOGRAPHIC AREA OF I-70 MOUNTAIN CORRIDOR

The I-70 Mountain Corridor covered by the context trends east-west through four major drainage basins and as many counties in the Colorado Rocky Mountains. The 120-mile long corridor links Floyd Hill, east of Idaho Springs, in Clear Creek County, with the west edge of Glenwood Springs, Garfield County. In width, the corridor extends beyond the I-70 right-of-way to include view sheds on both sides of the interstate. Because I-70 passes primarily along river and stream valleys, the view shed encompasses most of land within the valleys, from ridge to ridge. CDOT, in cooperation with FHWA, defined the corridor's geographic extent according to several criteria. First, the agencies based the length on plans for widening a comparable segment of I-70 from four to six lanes, with required shoulders and median. Second, the agencies based the width on input from corridor stakeholder groups, signatories to a programmatic agreement addressing the impacts of future construction projects and interstate use.

In Clear Creek County, the corridor follows Clear Creek westerly from the northeast base of Floyd Hill to the eastern portal of the Eisenhower Tunnel, crossing through the Continental Divide. The ridge serving as the Divide is also the boundary between Clear Creek and Summit counties. U.S. Highway 6, paralleling I-70 much of the way, turns south and crosses over Loveland Pass, near Eisenhower Tunnel. The context refers to this corridor segment as Clear Creek drainage. The principal communities in segment include, east to west, Idaho Springs, Spanish Bar, Dumont, Downieville, Lawson, Georgetown, Silver Plume, and Bakerville. All lie on Clear Creek valley floor, bounded by steep mountainsides. In the segment, the natural environment transitions from a Front Range foothills ecosystem to alpine conditions of the Continental Divide. Mining, the timber industry, electric power, tourism and recreation, and railroad and road transportation are principal historic themes. Clear Creek valley offered metamorphic geology rich with gold and silver ore formations, which supported a vibrant mining industry. The valley also featured thick forests for the logging industry, and gentle gradients used by railroads.

In Summit County, the corridor descends west along Straight Creek from the Eisenhower Tunnel's western portal to Dillon on the Blue River. The corridor veers southwest, crossing the broad Blue River valley to Frisco, and continuing south up Ten Mile Canyon to Copper Mountain. The corridor ascends west to Vail Pass, the boundary between Summit and Eagle counties. The context refers to the segment as the Dillon and Ten Mile Canyon area and the Blue River valley. The natural environment transitions from alpine conditions of the Continental Divide to subalpine spruce and lodgepole pine forests on mountainsides and open meadow and sage in Blue River valley, descending gently north. Ten Mile Canyon is narrow and bordered by abrupt alpine peaks and ridges. Principal communities include, east to west, Dillon, Silverthorne, Frisco, and Copper Mountain. Mining, the timber industry, electric power, tourism and recreation, railroad and road transportation, and high altitude agriculture are principal historic themes. The entire Blue River valley offered stands of tall lodgepole pines for a local logging industry, while the valley floor supported limited ranching and agriculture. Miners produced silver and industrial metals from metamorphic geology in Ten Mile Canyon, as well as gold from thick placer gravel around Dillon. Railroads crossed Blue River valley and ascended Ten Mile Canyon.

West of Vail Pass, the corridor enters Eagle County and descends a minor creek west through Vail to Minturn. At this point, the corridor follows the Eagle River to its confluence with the Colorado River at Dotsero. Although the rivers are distinct and separate, the valley is

nearly continuous. Its floor is broad, the westerly descent gentle, with the sides bordered by low peaks and ridges. The corridor continues down the Colorado River through Glenwood Canyon, a chasm with sheer bedrock cliffs, to Glenwood Springs. The context refers to this corridor segment as the Eagle and Colorado river valley. From east to west, principal communities include Vail, Minturn, Edwards, Wolcott, Eagle, Gypsum, and Dotsero. In the short distance between Dotsero and the mouth of Glenwood Canyon, the corridor enters Garfield County. The corridor passes through several ecosystems on its westerly descent, from subalpine spruce and lodgepole pine forest on Vail Pass to mixed forest and scrub around Minturn to semi-arid juniper-pinion forest in the western extent. In the segment, the timber industry, electric power, tourism and recreation, railroad and road transportation, and high altitude agriculture are principal historic themes. The sedimentary geology offered little for traditional mining. The Eagle and Colorado rivers also feature a rich riparian habitat. The broad and well-watered valley floor was conducive to ranching and limited agriculture, as well as a natural corridor for a railroad. The surrounding mountainsides provided timber for a logging industry, and open range for cattle. The Shoshone power plant still operates in Glenwood Canyon, near Grizzly Creek.



SECTION D: RESEARCH METHODOLOGY

The author derived the contexts from consultation with local consulting parties on the corridor and familiarity with I-70 Mountain Corridor history, its past land use patterns, and common property types. No surveys were conducted, as CDOT excluded fieldwork from project specifications. Based on analysis of the above, seven dominant historical themes became evident: mining industry, timber industry, agriculture, electric power generation, railroad transportation, road transportation, and tourism and recreation. Each theme was researched intensively in Denver area institutions, six in particular offering collections rich with archival materials. The institutions in order of relevance are: Denver Public Library Western History Collection; Colorado School of Mines; Colorado State Archives; University of Colorado at Boulder library system; and History Colorado's Steven S. Hart Library. Additional institutions offering limited information include Boulder Public Library; Summit County Historical Society; U.S. Forest Service; Bureau of Land Management; U.S. Department of Agriculture; and Colorado Department of Transportation.

Mining Industry

Although Clear Creek County was among Colorado's most productive centers of mining, no comprehensive histories of the region have been published. The work that has been done, while sound, focuses on either narrow timeframes or geographic areas. Similarly, little has been published on mining in Ten Mile Canyon and around Dillon. To adequately address both regions, the I-70 context relied on a handful of qualitative secondary sources and considerable primary material. Events, trends, and organizations important in history were derived from contemporary publications, mining periodicals, newspapers, state and federal government documents, and popular literature. Heavily cited contemporary publications include Orvando Hollister's 1867 *The Mines of Colorado*, Frank Fossett's 1880 *Colorado: Its Gold and Silver Mines*, and Colorado mining directories for 1879, 1883, 1898, and 1901. Federal publications include *Report of the Director of the Mint* serial published between 1881 and 1904. Annual mine inspectors' reports and mine engineers' reports were the principal state records.

Two approaches were useful for identifying significant timeframes. One was the materials identified above, and the other was a statistical analysis of population, ore production figures, and numbers of mines active between 1860 and 1980. These indicators were tabulated in five-year increments where possible, and the mines divided among small, medium, and large scale operations.

Although statistical analysis has inherent weaknesses, it is well equipped for identifying significant timeframes. For example, sudden rises in both population and the numbers of prospects can be interpreted as a period of discovery and boom. Gradual population growth combined with high production figures and an increase in small- and medium-sized mines often reflects the early phase of a productive mining industry. A slight contraction in population, an increase in large operations, and an increase in production figures suggests maturation. In terms of weaknesses, statistical analysis relies on the accuracy of archival resources. The five-year increments between 1885 and 1897 were poorly covered, and some important mines were not reported even though active. In addition, it seems likely that many prospects were not reported because of their unimportance at the time.

Several NRHP Multiple Property Documentation Forms have been produced for mining industries in Colorado. The author borrowed heavily from these for Section B of the I-70 context. The author and Jay Fell, Ph.D., co-produced *The Mining Industry in Colorado Multiple Property Documentation Form* statewide mining industry context in 2008. The author also produced *Amendment to Tourist Era and Metal Mining Resources in Boulder County Multiple Property Documentation Form* in 2007 and *Mining Resources of San Juan County Multiple Property Documentation Form* in 2010. Both are available through History Colorado. The author's treatise on mining technology, *Riches to Rust*, supported discussions of methods and machinery, and blocks of text were copied into Section B.

Timber Industry

The timber industry was nearly as significant in corridor history as mining and railroads. The timber industry provided the physical materials on which mining, railroads, other forms of business, and settlements depended. And yet, the industry received little recognition in either archival sources or popular literature. Given this, the history of the timber industry, its property types, and establishing their registration requirements appear to be original work.

The I-70 context discusses timber industry history separately for three principal segments of the corridor. Each had its own industry influenced by local demand, geography, trends, and external markets. Their histories had to be pieced together and interpreted from a combination of industry-specific information, and regional events and trends influencing demand for forest products. Relevant sources were historic publications, business directories, newspapers, and local history publications. William Wroten's 1956 thesis *The Railroad Tie Industry in the Central Rocky Mountain Region, 1867-1900* provided information on forest management and railroad tie harvest. George B. Sudworth's 1900 "White River Plateau Timber Land Reserve" *Twentieth Annual Report of the United States Geological Survey to the Secretary of the Interior, 1898-1899* offered similar information. Erl and Carrie Scott Ellis's *The Saga of Upper Clear Creek: A Detailed History of an Old Mining Area, Its Past and Present* yielded information about forest policy in the corridor, as well as notes on Clear Creek logging.

The timber industry in each corridor segment had its own significant timeframes, estimated from the interaction of three principal factors. First, the timber industry was primarily a function of mining and railroad construction, with their boom-and-bust cycles governing most timeframes. Second, fluctuations in demand among external markets were influential, and third, the exhaustion of forests was a fundamental factor. Although the U.S. Census kept some statewide records of logging and lumber production, information by region was unavailable.

There are no existing statewide timber industry contexts to serve as examples for developing property types presented in Section B. Thus, the section is largely original. Structurally, Section B is modeled after the mining industry section because logging and mining were similar industries. The author based the property types and their features on his experience interpreting and evaluating historic logging resources.

High Altitude Agriculture

A combination of primary and secondary sources provided enough information for a basic history. The most important were popular literature, and contemporary newspapers and publications. Thorough research was unnecessary because influential trends such as settlement,

development of local markets, and transportation had already been determined in the context's other sections. Frequently cited works include Ken Reyher's 2002 *High Country Cowboys: A History of Ranching in Western Colorado* and Steven F. Mehls' 1988 *The Valley of Opportunity: A History of West-Central Colorado*.

The discussion of property types in Section B is based on two bodies of information, with original material added. *Historic Ranching Resources of South Park, Colorado*, a Multiple Property Documentation Form by architectural historians Thomas and Laurie Simmons, provided property types, language, and registration requirements. Because the document emphasizes the built environment, the author added archaeological resources based on his and others' experience. Architectural historian and contributor Carl McWilliams developed additional building types from professional experience and a review of records at the Office of Archaeology and Historic Preservation.

Electric Power Generation

The I-70 context discusses electric power history separately for the corridor's three principal segments. The histories had to be pieced together and interpreted from a combination of industry-specific information, as well as regional events and trends influencing the development of electrical grids. Coverage in archival sources is minimal, only a handful of recent publications exist, and no statewide contexts have been published. Given this, the history of electrical generation in the corridor, its property types, and their registration requirements appear to be original work. The most important sources are Public Service Company manuscripts, historic newspapers, and mining industry periodicals.

The power industry in each corridor segment had its own significant timeframes, determined from four principal factors. First, power companies initially built plants to serve mining and dependent settlements. The mining industry shaped early power generation as a principal customer base, as well as through its boom-and-bust cycles. Second, advances in electrical technology influenced periodic developments in the grids. Third, consolidations of local electric companies were benchmarks. Last, unification of all the grids into one system, and associated closure of some power plants, was a turning point for all systems.

There are no electrical generation contexts providing examples for property types in Section B. Thus, the work is largely original. Structurally, Section B is modeled after the mining industry section because power generation and mining were industries dependent on technology. The author based the property types and their features on archival research, as well as his experience interpreting and evaluating early power generation resources.

Railroad Transportation

Railroads in Colorado are a beloved institution among historians, who have conducted exhaustive research and published dozens of books on the subject during the last fifty years. The excellent body of work is based on primary research, and although these publications are secondary sources, their exhaustiveness supports the railroad section. Thus, little primary research was undertaken in an attempt to avoid repetition.

The historic context and property type sections are based on two categories of publications. The body of popular literature was the principal source for railroad histories. Because the individual lines in the corridor were components of larger systems, the histories of

these systems had to be considered for a full understanding of the lines. The individual lines also had to be placed in the framework of their surrounding service regions, whose histories are covered in other sections of this context. Section B of the I-70 context borrowed heavily from Clayton Fraser and Jennifer H. Strand's *Railroads in Colorado, 1858-1948: Multiple Property Documentation Form*. Fraser, of Fraserdesign, produced the statewide railroad context in 1997 for the Foundation for Colorado State Parks with a grant by the State Historical Fund. The I-70 context expands on that document's general property types, significance statements, and registration requirements. Fraser limited his coverage to intact engineered structures and architecture. Missing are smaller components of rail systems and archaeological resources, presented here.

Road Transportation

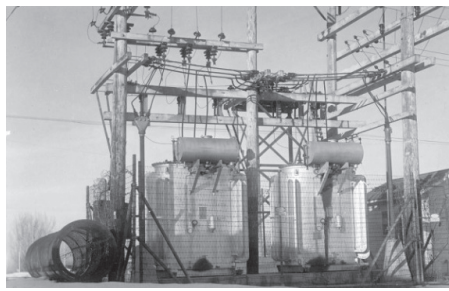
A combination of primary and secondary sources provided information on wagon roads and pack trails, with trends and historic patterns for the corridor's other themes providing background. Several contexts in publication also provided guidance and structure for auto roads and highways. In 2002, Associated Cultural Resource Experts (ACRE) developed a statewide highway context for the Colorado Department of Transportation entitled *Highways to the Sky: A Context and History of Colorado's Highway System*. In 2003, the Office of Archaeology and Historic Preservation adapted *Highways to the Sky* to developed the *Colorado State Roads and Highways: National Register of Historic Places Multiple Property Submission* statewide context, not yet approved by the Keeper of the National Register. These documents, others in the bibliography, and knowledge of the I-70 corridor provided information for property types in Section B. Intensive archival research was not conducted to avoid repetition, and because the existing body of work is adequate.

Tourism and Recreation

The I-70 context divided the broad topic of tourism and outdoor recreation into three categories represented by historic resources. The categories include the ski industry, resort tourism, and outdoor recreation. A combination of secondary and some primary sources provided enough information for a basic history of resort tourism, although coverage was sparse. The most useful sources were contemporary newspapers and publications, such as Aaron Frost's 1880 "History of Clear Creek County" in *History of Clear Creek and Boulder Valleys, Colorado*. Ethel Morrow Gillett's *Idaho Springs: Saratoga of the Rockies; A History of Idaho Springs, Colorado*, 1978, and *Tailings, Tracks, & Tommyknockers: History of Clear Creek County*, 1986, were among the best secondary sources. The context for skiing relied mostly on secondary sources because they covered the subject well. Abbott Fay's 2000 book *A History of Skiing in Colorado* and Annie Gilbert Coleman's 2004 work entitled *Ski Style: Sport and Culture in the Rockies* provided background the evolution of skiing, especially in Colorado. U.S. Forest Service historian Paul Hauk wrote a series of publications on ski areas in the White River National Forest, published in 1979 by the Forest Service. The history of outdoor recreation had to be pieced together from a variety of primary and secondary sources, given the lack of comprehensive works for the region. Local histories such as Andrew Guiliford's 1983 *Garfield County, Colorado: The First Hundred Years, 1883-1983* yielded some information on outdoor activities, as did contemporary publications such as William McCabe's 1899 *The Empire of the*

Eagle: A Descriptive History of a Great County. Overview works including William Wyckoff 1999 *Creating Colorado; the Making of a Western American Landscape, 1860-1940* provided broad context for the outdoor movement.

Section B and its discussion of property types were mostly original, drawing some information regarding significance from the research sources. The property types were based on the author's and historical archaeologist Michelle Slaughter's experience, and forecasts of resource types likely in the corridor.



SECTION E: MAJOR BIBLIOGRAPHIC SOURCES

General History

Abbott, Carl, Leonard, Stephen, and McComb, David. *Colorado: A History of the Centennial State*. Niwot, CO: University Press of Colorado, 1994 [1982].

Armitage, Susan and Jameson, Elizabeth. *The Women's West*. Norman, OK: University of Oklahoma Press, 1987.

Baker, James H. *History of Colorado*. Denver, CO: Linderman Co., Inc., 1927.

Bauer, William H., Ozment, James L., Willard, John H. *Colorado Post Offices: 1859-1989*. Golden, CO: The Colorado Railroad Museum, 1990.

Breckenridge Bulletin. Breckenridge, CO [various untitled articles referenced by issue].

Colorado Business Directory. Denver, CO: J.A. Blake, 1874-1882.

Colorado Business Directory. Denver, CO: James R. Ives & Co., 1883-1896.

Colorado Business Directory. Denver, CO: Gazetteer Publishing & Printing Co., 1897-1960.

Crofutt, George A. *Crofutt's Grip-Sack Guide to Colorado: A Complete Encyclopedia of the State*. Omaha, NE: Overland Publishing Company, 1885 [reprinted by Cubar Associates, Golden, CO, 1966].

Denver Post. Denver, CO [various untitled articles referenced by issue].

Denver Republican. Denver, CO, [various untitled articles referenced by issue].

Denver Times. Denver, CO [various untitled articles referenced by issue].

Denver Tribune. Denver, CO [various untitled articles referenced by issue].

Georgetown Courier. Georgetown, CO [various untitled articles referenced by issue].

Hall, Frank *History of Colorado, V.1*. Chicago, IL: Blakely Printing Co., 1889.

Hall, Frank *History of Colorado V.2*. Chicago, IL: Blakely Printing Co., 1890.

Hall, Frank *History of Colorado V.3*. Chicago, IL: Blakely Printing Co., 1891.

Hall, Frank *History of Colorado V.4*. Chicago, IL: Blakely Printing Co., 1895.

History of the Arkansas Valley. Chicago, IL: O.L. Baskin, 1881.

Myres, Sandra L. *Westering Women and the Frontier Experience, 1800-1915*. Albuquerque, NM: University of New Mexico Press, 1999.

Noel, Thomas J and Norgren, Barbara S. *Denver: The City Beautiful and its Architects, 1893-1941*. Denver, CO: Historic Denver, Inc., 1987.

Norman, Reuben O. *Who's Who of Denver 1931-1932*. Denver, CO: The Blue Book Company, 1932.

"Obituary." *Engineering & Mining Journal* (1875-1920).

"Obituary." *Mining Reporter* (1890-1920).

"Obituary." *Mining & Scientific Press* (1875-1920).

Portrait and Biographical Record of Denver and Vicinity, Colorado. Chicago, IL: Chapman Publishing Co., 1898.

Portrait and Biographical Record of the State of Colorado. Chicago, IL: Chapman Publishing Co., 1899.

"Prominent Men in the Mining Industry" *Engineering & Mining Journal* (5/30/91).

Rocky Mountain News. Denver, CO [various untitled articles referenced by issue].

Schulze, Susanne. *A Century of the Colorado Census*. Greeley, CO: University of Northern Colorado, 1976.

Smiley, Jerome C. *Semi-Centennial History of the State of Colorado*. Chicago, IL: Lewis Publishing Co., 1913.

Smith, Duane A. *Rocky Mountain Mining Camps: the Urban Frontier*. Lincoln, NE: University of Nebraska Press, 1974 [1967].

Smith, Duane A. *Rocky Mountain West: Colorado, Wyoming, & Montana 1859-1915*. Albuquerque, NM: University of New Mexico Press, 1992.

Stone, Wilbur Fisk. *History of Colorado, Vol. 1-4*. Chicago, IL: S.J. Clarke Publishing Co., 1918.

Summit County Journal. Breckenridge, CO [various untitled articles referenced by issue].

Who's Who in Colorado: A Biographical Record of Colorado's Leaders in Business, Professional, and Public Life. Boulder, CO: Colorado Press Association, University of Colorado, 1938.

Zanjani, Sally. *A Mine of Her Own: Women Prospectors in the American West, 1850-1950*. Lincoln, NE: University of Nebraska Press, 2002.

Mining Industry, General

Brown, Robert L. *An Empire of Silver*. Denver, CO: Sundance Publications, 1984.

Brown, Ronald. *Hard Rock Miners: The Intermountain West, 1860-1920*. Texas A&M Press, 1979.

Bureau of Mines. *Manuscripts*. Denver, CO: Colorado Historical Society.

Canfield, John G. *Mines and Mining Men of Colorado*. Denver, CO: John G. Canfield, 1893.

Collins, George E. "Metal Mining in Colorado During 1905." *Engineering & Mining Journal* (1/6/06): 32.

Collins, George E. "Mining in the United States in 1906: Colorado." *Engineering & Mining Journal* (1/5/07): 29.

Collins, George E. "Mining in the United States in 1907: Colorado." *Engineering & Mining Journal* (1/4/08): 38.

Collins, George E. "Mining in the United States during 1908: Colorado." *Engineering & Mining Journal* (1/9/09): 104-105.

Collins, George E. "Mining in the United States during 1909: Colorado." *Engineering & Mining Journal* (1/8/10): 97-98.

Collins, George E. "Metal Mining in Colorado in 1913." *Engineering & Mining Journal* (1/10/14): 116-117.

Collins, George E. "Mining in Colorado in 1917." *Engineering & Mining Journal* (1/19/18): 143.

Collins, George E. "Mining in Colorado in 1918." *Engineering & Mining Journal* (1/18/19): 152.

- Collins, George E. "Mining in Colorado in 1919." *Engineering & Mining Journal* (1/17/20): 161.
- Colorado Mine Engineers' Reports. Denver, CO: Colorado State Archives.
- Colorado Mine Inspectors' Reports. Denver, CO: Colorado State Archives.
- Colorado Mining Directory, 1879*. Denver, CO: The Rocky Mountain News Printing Co., 1879.
- Colorado Mining Director, 1883*. Denver, CO: The Colorado Mining Directory Co., 1883.
- Colorado Mining Directory, 1896*. Denver, CO: J.S. Bartow and P.A. Simmons, 1896.
- Colorado Mining Directory, 1898*. Denver, CO: Western Mining Directory Company, 1898.
- Colorado Mining Directory, 1901*. Denver, CO: Wahlgreen Printing Co., 1901.
- "Current News." *Mining Science* (1907-1913).
- Dallas, Sandra. *Colorado Ghost Towns and Mining Camps*. Norman, OK: University of Oklahoma Press, 1984 [1979].
- Del Rio, S.M. *Mineral Resources of Colorado: First Sequel*. Denver, CO: State of Colorado Mineral Resources Board, 1960.
- Eberhart, Perry. *Guide to the Colorado Ghost Towns and Mining Camps*. Athens, OH: Swallow Press, 1987 [1959].
- "Editorial Correspondence: Denver." *Engineering & Mining Journal* (6/4/10): 1191.
- "Editorial Correspondence: Denver." *Engineering & Mining Journal* (7/30/10): 230.
- "Editorial Correspondence." *Engineering & Mining Journal* (4/4/14): 729.
- "Editorial Correspondence." *Engineering & Mining Journal* (10/17/14): 718.
- "Editorial Correspondence." *Engineering & Mining Journal* (5/15/15): 879.
- "Editorial Correspondence." *Engineering & Mining Journal* (6/29/18): 1191.
- "End of Pittman Silver Purchases Cut Profits Sharply." *Engineering & Mining Journal* (12/1/23): 960.
- "Events and Economics of the War." *Engineering & Mining Journal* (5/18/18): 926.
- Fell, James E., Jr. *Ores to Metals: The Rocky Mountain Smelting Industry*. Lincoln, NE: University of Nebraska Press, 1979.
- Fossett, Frank. *Colorado: Historical, Descriptive and Statistical Work on the Rocky Mountain Gold and Silver Mining Region*. Denver, CO: Daily Tribune, 1876.
- Fossett, Frank. *Colorado: Its Gold and Silver Mines, Farms and Stock Ranges, Health and Pleasure Resorts*. New York, NY: C.G. Crawford, 1880.
- Francoaviglia, Richard. *Hard Places: Reading the Landscape of America's Historic Mining Districts*. Iowa City, IA: University of Iowa Press, 1991.
- "General Mining News." *Mining Industry* (1887-1890).
- "General Mining News." *Mining Industry and Tradesman (MIT)* (1890-1897).
- "Gold and Silver Stocks." *Engineering & Mining Journal* (2/12/1876).

Henderson, Charles W. *Professional Paper 138: Mining in Colorado: A History of Discovery, Development, and Production*. Washington, D.C.: U.S. Geological Survey, Government Printing Office, 1926.

King, Joseph. *A Mine to Make A Mine: Financing the Colorado Mining Industry, 1859-1902*. Texas A&M University Press, 1977.

"Industrial News from Washington." *Engineering & Mining Journal* (4/27/18): 804.

"Latest Mining News." *Rocky Mountain Mining Review (RMMR)* (1880-1887).

McElvaine, Robert S. *The Great Depression: America, 1929-1941*. New York, NY: Times Books, 1993 [1984].

"Mineral Production of Colorado for 1876." *Engineering & Mining Journal* (3/17/77): 171.

Mineral Resources of the United States. Washington, D.C.: U.S. Geological Survey, Government Printing Office, 1906-1931.

Minerals Yearbook. U.S. Department of the Interior, U.S. Government Printing Office, 1932-1970.

"Mining News." *Engineering & Mining Journal (EMJ)* (1875-1922).

"Mining News." *Mining and Industrial Reporter (MIR)* (1897-1898).

"Mining News." *Mining & Scientific Press (MSP)* (1875-1920).

"Mining News." *Mining Reporter* (1898-1907).

"Mining Notes from Colorado, Missouri, Montana, Nevada, and Northern Carolina." *Engineering & Mining Journal* (7/29/76): 77.

"News from Washington." *Engineering & Mining Journal* (7/28/23): 165.

Report of the Director of the Mint. Washington, D.C.: Government Printing Office, 1881-1904.

Saxon, Glenn O. *Colorado and Its Mining Industry (1859-1959)*. Yale University, 1959.

Smith, Duane A. *Song of the Hammer and Drill: The Colorado San Juans, 1860-1914*. Golden, CO: Colorado School of Mines, 1982.

"Special Correspondence from Mining Centers: Denver." *Engineering & Mining Journal* (11/6/09): 943.

Spence, Clark C. *Mining Engineers and the American West*. Moscow, ID: University of Idaho Press, 1993.

Vanderwilt, John W. *Mineral Resources of Colorado: First Sequel*. Denver, CO: State of Colorado Mineral Resources Board, 1947.

Voynick, Stephen M. *Colorado Gold: From the Pike's Peak Rush to the Present*. Missoula, MT: Mountain Press Publishing Co., 1992.

Wickersheim, Laurel Michele and LeBaron, Rawlene. *Mine Owners and Mines of the Colorado Gold Rush*. Westminster, MD: Heritage Books, 2005.

Wolle, Muriel Sibel. *Stampede to Timberline: The Ghost Towns and Mining Camps of Colorado*. Swallow Press, University of Ohio Press, 1991 [1949].

Wyman, Mark. *Hard Rock Epic: Western Mining and the Industrial Revolution, 1860-1910*. Berkeley, CA: University of California Press, 1989 [1979].

Mining Industry, Clear Creek County

"Atlantic-Pacific." *Rocky Mountain Mining Review* (11/25/80): 11.

Brown, Robert L. *The Great Pikes Peak Gold Rush*. Caldwell, ID: Caxton Printers, 1985.

Callbreath, James F. "The Mineral Resources of Clear Creek County." *Mining Reporter* (8/24/99): 120.

Callbreath, James F. "The Mineral Resources of Clear Creek County." *Mining Reporter* (8/31/99): 134

"Clear Creek County." *Rocky Mountain Mining Review* (6/26/84): 1.

"Clear Creek County." *Mining Reporter* (1/9/02): 42

Colorado Historical Society. *Hotel de Paris and Louis Dupuy in Georgetown, Colorado*. Boulder, CO: Johnson Publishing Company, 1954.

"Custom Milling Plants at Idaho Springs, Colorado." *Mining Reporter* (6/28/06): 636.

Dickinson, H.P. "Deep Mining Tunnels in Clear Creek County, Colorado." *Mining Reporter* (4/16/08): 382.

Dillenback, Jackson D. *Facts about Empire*. Denver, CO: The William Haffner Engraving Co., [circa 1898].

Draper, Benjamin. *Georgetown Pictorial: An Illustrated Story of a Colorado Mining Town*. Denver, CO: Old West Publishing Company, 1964.

"Electricity in the Clear Creek County (Colorado) Mines." *Mining Reporter* (1/16/02): 96.

Ellis, Erl H. and Ellis, Carrie Scott. *The Saga of Upper Clear Creek: A Detailed History of an Old Mining Area, Its Past and Present*. Frederick, CO: Jende-Hagan Book Corporation, 1983.

Fossett, Frank. *Colorado Mines: 1859-1879 Boulder and Gilpin Counties* [Reprinted from *Colorado, Its Gold and Silver Mines, Farms and Stock Ranges, and Health and Pleasure Resorts – Tourist's Guide to the Rocky Mountains*. 1879 [reprint by Gold Dirt Press, Colorado Springs, CO, 1999].

Frost, Aaron. "History of Clear Creek County." *History of Clear Creek and Boulder Valleys, Colorado*. Chicago, IL: O.L. Baskin & Company, 1880.

"Georgetown." *Rocky Mountain Mining Review* (6/12/84): 9.

Georgetown Chamber of Commerce. *Historic Georgetown*. Denver, CO: A.B. Hirschfield Press, 1968.

Harrison, Louise C. *Empire and the Berthoud Pass*. Denver, CO: Big Mountain Press, 1964.

Hollister, Ovando J. *The Mines of Colorado*. Springfield, MA: Samuel Bowles & Co., 1867. [Reprinted by Promontory Press, New York, NY, 1974].

Horner, John W. *Silver Town*. Caldwell, ID: Caxton Printers, 1967.

"Idaho Springs." *Rocky Mountain Mining Review* (6/12/84): 8.

Jessen, Kenneth. *Georgetown: A Quick History*. First Light Publishing, 1996.

Leyendecker, Liston E. *The Griffith Family and the Founding of Georgetown*. Boulder, CO: University Press of Colorado, 2001.

Leyendecker, Liston E., Bradley, Christine A., and Smith, Duane A. *The Rise of the Silver Queen: Georgetown*.

Colorado, 1859-1896. Boulder, CO: University Press of Colorado, 2005.

"The Lower Clear Creek Mining District." *Mining Science* (5/11/11): 495.

Miller, H.J. [Untitled report on Gem Mine, Clear Creek County] Denver, CO, 1912.

"The Mines About Empire." *Mining Industry* (11/25/87): 11.

Moench, Robert H. and Drake, Avery Ala. *Bulletin 1208: Economic Geology of the Idaho Springs District, Clear Creek and Gilpin County, Colorado*. Washington, DC: U.S. Geological Survey, United States Government Printing Office, 1966.

Moench, Robert H. and Drake, Avery Ala. *Mines and Prospects, Idaho Springs District, Clear Creek and Gilpin County, Colorado*. United States Geological Survey open file report 1965, 1966.

"The Newhouse Tunnel." *Summit County Journal* (8/5/05): 2.

"Newhouse Tunnel Complete." *Mining Science* (11/24/10): 499.

"Prominent Mines of Clear Creek County." *Mining Industry* (1/20/88): 9.

Spurr, J.E. and Garrey, George H. "The Idaho Springs Mining District of Colorado." *Mining Reporter* (1/17/07): 73.

Spurr, Josiah E. and Garrey, George H. *Professional Paper 63: Economic Geology of the Georgetown Quadrangle*. Washington, D.C.: U.S. Geological Survey, Government Printing Office, 1908.

"Summit County." *Mining Reporter* (2/22/1900): 106.

Tailings, Tracks, & Tommyknockers: History of Clear Creek County. Denver, CO: Specialty Publishing Company, 1986.

Warwick, A.R. "The Newhouse Tunnel." *Mining Reporter* (4/24/02): 398.

Mining Industry, Summit County

Callbreath, James F. "The Mineral Resources of Summit County." *Mining Reporter* (12/21/99): 370.

Dempsey, Stanley and Fell, James E. Jr. *Mining the Summit: Colorado's Ten Mile District, 1860-1960*. Norman, OK: University of Oklahoma Press, 1986.

Ellis, Erl H. *The Gold Dredging Boats Around Breckenridge, Colorado*. Boulder, CO: Johnson Publishing Co., 1967.

Fiester, Mark *Blasted, Beloved Breckenridge* Breckenridge, CO: Weber's Books and Drawings, 1994 [1973].

Gilliland, Mary Ellen. *Summit: A Gold Rush History of Summit County, Colorado*. Silverthorne, CO: Alpenrose Press, 1999.

Koschmann, A.H. "Tenmile Mining District, Colorado." *Guidebook: Rocky Mountain Association of Geologists*. Rocky Mountain Association of Geologists, 1947.

Lakes, Arthur. "The General Geology of Summit County, Colorado." *Engineering & Mining Journal* (3/5/08): 243.

Sharp, Verna. *A History of Montezuma, Sts. John, and Argentine: Early Mining Camps of Summit County*. Dillon, CO: D & L Printing, Inc., 1971.

Summit County Mining Exchange. *Goldfields of Summit County, Colorado*. Breckenridge, CO: Summit County Mining Exchange [circa 1905].

Mining Technology

Bailey, Lynn *Supplying the Mining World: the Mining Equipment Manufacturers of San Francisco 1850-1900* Tucson, AZ: Western Lore Press, 1996.

Bailey, Lynn *Shaft Furnaces and Beehive Kilns: A History of Smelting in the Far West, 1863-1900* Tucson, AZ: Westernlore Press, 2002.

Bramble, Charles A. *The ABC of Mining: A Handbook for Prospectors* Santa Monica, CA: Geology, Energy & Minerals Corporation, 1980 [1898].

Colliery Engineer Company *Coal & Metal Miners' Pocketbook* Scranton, PA: Colliery Engineer Company, 1893.

Colliery Engineer Company *Coal Miners' Pocketbook* New York, NY: McGraw-Hill Book Co., 1916.

Croft, Terrell *Steam Boilers* New York, NY: McGraw-Hill Book Co., 1921.

Drew, J.M. *Farm Blacksmithing: A Manual for Farmers and Agricultural Schools* St. Paul, MN: Webb Publishing Co., 1910.

Eaton, Lucien *Practical Mine Development & Equipment* New York, NY: McGraw-Hill Book Company, 1934.

Engineering & Mining Journal *Details of Practical Mining* New York, NY: McGraw-Hill Book Company, Inc, 1916.

Foster, Clement *A Textbook of Ore and Stone Mining* London: Charles Griffin & Co., 1894.

General Electric Company *Electric Mine Locomotives: Catalogue No. 1045* Chicago, IL: General Electric Power and Mining Department [Trade Catalog], 1904.

Gillette, Halbert P. *Rock Excavation: Methods and Cost* New York, NY: Myron C. Clark Publishing Company, 1907.

Greeley, Horace; Case, Leon; Howland, Edward; Gough, John B.; Ripley, Philip; Perkins, E.B.; Lyman, J.B.; Brisbane, Albert; Hall, E.E. "Babcock and Wilcox Boiler" *The Great Industries of the United States* Hartford, CT: J.B. Burr, 1872.

Hoover, Herbert C. *Principles of Mining* New York, NY: McGraw-Hill Book Co., 1909.

Ihlseng, Magnus *A Manual of Mining* New York, NY: John Wiley & Sons, 1892.

Ihlseng, Magnus *A Manual of Mining* New York, NY: John Wiley & Sons, 1901.

Ingersoll-Rand Co. *Leyner Drill Sharpener "I-R" Model: Instructions for Installing and Operating* New York, NY: Ingersoll-Rand Co., 1913.

Ingersoll Rock Drill Company *Catalogue No.7: Rock Drills, Air Compressors and Air Receivers* New York, NY: Ingersoll Rock Drill Company, 1887.

Ingersoll-Rand Drill Company *Today's Most Modern Rock Drills & A Brief History of the Rock Drill Development* New York, NY: Ingersoll-Rand Drill Company, 1939.

International Correspondence Schools *Rock Boring, Blasting, Coal Cutting, Trackwork* Scranton, PA: International Textbook Co., 1907.

International Textbook Company *A Textbook on Metal Mining: Steam and Steam-Boilers, Steam Engines, Air and Air Compression, Hydromechanics and Pumping, Mine Haulage, Hoisting and Hoisting Appliances, Percussive and Rotary Boring* Scranton, PA: International Textbook Company, 1899.

International Textbook Company *Coal and Metal Miners' Pocket Book* Scranton, PA: International Textbook Company, 1905.

International Textbook Company *International Library of Technology: Hoisting, Haulage, Mine Drainage* Scranton, PA: International Textbook Company, 1906.

International Textbook Company *International Correspondence School Reference Library: Rock Boring, Rock Drilling, Explosives and Blasting, Coal-Cutting Machinery, Timbering, Timber Trees, Trackwork* Scranton, PA: International Textbook Company, 1907.

International Textbook Company *International Library of Technology: Mine Surveying, Metal Mine Surveying, Mineral-Land Surveying, Steam and Steam Boilers, Steam Engines, Air Compression* Scranton, PA: International Textbook Company, 1924.

International Textbook Company *Mine Haulage: Rope Haulage in Coal Mines, Locomotive Haulage in Coal Mines, Mine Haulage Systems, Calculations, and Cars* Scranton, PA: International Textbook Company, 1926.

Ketchum, Milo S. C.E. *The Design of Mine Structures* New York, NY: McGraw-Hill Book Co., 1912.

Keystone Consolidated Publishing Company Inc. *The Mining Catalog: 1925 Metal-Quarry Edition* (no location given): Keystone Consolidated Publishing Company Inc., 1925.

Kleinbans, Frank B. *Locomotive Boiler Construction* New York, NY: Norman W. Henley Publishing Co., 1915.

Lewis, Robert S. *Elements of Mining* New York, NY: John Wiley & Sons, Inc., 1946 [1933].

Linstrom, C.B. & Clemens, A.B. *Steam Boilers and Equipment* Scranton, PA: International Textbook Co., 1928.

Meyerriecks, Will *Drills and Mills: Precious Metal Mining and Milling Methods of the Frontier West* Tampa, FL: Self Published, 2001.

Morrison's Mining Rights Denver, CO: 1899 [1882].

Peele, Robert *Mining Engineer's Handbook* New York, NY: John Wiley & Sons, 1918.

Prelini, Charles *Earth & Rock Excavation* New York, NY: D. Van Nostrand Co., 1906.

Rand Drill Company *Illustrated Catalogue of the Rand Drill Company, New York, U.S.A.* New York, NY: Rand Drill Company, 1886.

Rand Drill Company *Imperial Type 10 Air Compressors* New York, NY: Rand Drill Co., 1904.

Silver World (10/5/78), Lake City, CO.

Staley, William *Mine Plant Design* New York, NY: McGraw-Hill Book Co., 1936.

Thorkelson, H.J. *Air Compression and Transmission* New York, NY: McGraw-Hill Book Company, Inc., 1912.

Thurston, R.H. *A Manual of Steam Boilers: Their Design, Construction, and Operation* New York, NY: John Wiley & Sons, 1901.

Tinney, W.H. *Gold Mining Machinery: Its Selection, Arrangement, & Installation* New York, NY: D. Van Nostrand Company, 1906.

Trennert, Robert A. "From Gold Ore to Bat Guano: Aerial Tramways in the West" *The Mining History Journal* (1997).

Twitty, Eric "From Steam Engines to Electric Motors: Electrification in the Cripple Creek Mining District" *The Mining History Journal* (1998):103.

Twitty, Eric *Reading the Ruins: A Field Guide for Interpreting the Remains of Western Hardrock Mines* Master's Thesis, Denver, CO: University of Colorado, 1999.

Twitty, Eric *Blown to Bits in the Mine: A History of Mining and Explosives in the United States* Montrose, CO: Western Reflections, 2001.

Twitty, Eric *Riches to Rust: A Guide to Mining in the Old West* Montrose, CO: Western Reflections, 2002.

Young, George *Elements of Mining* New York, NY: John Wiley & Sons, 1923.

Young, George *Elements of Mining* New York, NY: John Wiley & Sons, 1946.

Zurn, E.N. *Coal Miners' Pocketbook* New York, NY: McGraw-Hill Book Co., 1928 [Colliery Engineering Co., 1890].

Timber History

Bureau of the Census. *Census of Forest Products: 1941 Production of Lumber by Counties*. Washington, D.C.: Government Printing Office, 1942.

Bureau of the Census. *Forest Products of the United States, 1907*. Washington, D.C.: Government Printing Office, 1909a.

Bureau of the Census. *Forest Products of the United States, 1908*. Washington, D.C.: Government Printing Office, 1909b.

Bureau of the Census. *Forest Products of the United States, 1909*. Washington, D.C.: Government Printing Office, 1911.

Bureau of the Census. *Forest Products: Lumber, Lath, and Shingles*. Washington, D.C.: Government Printing Office, 1911-1930.

Daily Colorado Miner (5/27/73): 3.

Defebaugh, James Elliott. *History of the Lumber Industry of America*. Chicago, IL: The American Lumberman, 1906.

Etheredge, Tracy L. *An Inventory of the Records of the Hallack and Howard Lumber Company*. Denver, CO: Colorado Historical Society, 1991.

Farmer, E.J. *The Resources of the Rocky Mountains, Being a Brief Description of the Mineral, Grazing, Agricultural and Timber Resources of Colorado, Utah, Arizona, New Mexico, Wyoming, Idaho, Montana, and Dakota*. Chicago, IL: Leader Printing Company, 1991.

"Free Timber from the National Forest." *Georgetown Courier* (3/18/33): 1.

Pre-Emption, Homestead and Timber Culture: Information for Those Interested in Securing a Free Home in the San Luis Park, Colorado [pamphlet, no publisher, no date, on file at Denver Public Library].

Reich, William L. *Colorado Industries of the Past*. Boulder, CO: Johnson Books, 2008.

Renze, Dolores C. *A Brief Study of the Lumber Industry in Colorado*. Denver, CO: University of Colorado at Denver, 1949 [term paper].

Runte, Alfred. *Public Lands Heritage: The National Forest Idea*. Niwot, CO: Roberts Rinehart Publishers, 1991.

Smego, James H., Switzer, William E., Betters, David R., Donnelly, Dennis M., and Worth, Harold E. *Timber Utilization and Marketing Alternatives for Colorado and Wyoming*. U.S. Department of Agriculture, 1984.

Steen, Harold K. *The U.S. Forest Service: A History*. Seattle, WA: University of Washington Press, 1976.

Steen, Harold K. *The Beginning of the National Forest System*. Washington, D.C.: U.S. Department of Agriculture, 1991.

Steer, Henry B. *Lumber Production in the United States, 1799-1946*. Washington, D.C.: U.S. Department of Agriculture, 1948.

Sudworth, George B. "White River Plateau Timber Land Reserve." *Twentieth Annual Report of the United States Geological Survey to the Secretary of the Interior, 1898-1899*. Washington, D.C.: Government Printing Office, 1900.

Wroten, William H. *The Railroad Tie Industry in the Central Rocky Mountain Region, 1867-1900*. University of Colorado, 1956 [Dissertation].

High Altitude Agriculture

Billington, R.A. *Westward Expansion: A History of the American Frontier*. New York, NY: MacMillan Publishing Company, Inc., 1974.

Burdick, R.T., Reinholt M., and Klemmedson, G.S. *Bulletin 342: Cattle-Ranch Organization in the Mountains of Colorado*. Fort Collins, CO: Colorado Experiment Station, Colorado Agricultural College, 1928.

Goetzmann, W.H. *Exploration and Empire: The Explorer and the Scientist in the Winning of the American West*. New York, NY: Knopf, 1966.

Hafen, L.R. *Colorado: The Story of the State and its People*. Denver, CO: The Old West Publishing Company, 1945.

Harris, Katherine. *Long Vistas: Women and Families on Colorado Homesteads*. Niwot, CO: University Press of Colorado, 1993.

Holleran, Michael. *Historic Context for Irrigation and Water Supply: Ditches and Canals in Colorado*. Denver, CO: University of Colorado at Denver and Health Sciences Center, 2005.

Knight, MacDonald and Hammock, L.A. *Early Days on the Eagle: Biographical History of Pioneer Life in Colorado's Eagle River Valley*. Eagle, CO: Knight and Hammock, 1965.

Mehls, Steven F. *The Valley of Opportunity: A History of West-Central Colorado*. Denver, CO: Bureau of Land Management, Colorado State Office, 1988.

Moore, Charles F., Brown, Everett L., and Snyder, Henry E. *Early History of Taylor Grazing Act in Colorado*. Bureau of Land Management Information Memorandum No. 81-229, 1981.

Reyher, Ken. *High Country Cowboys: A History of Ranching in Western Colorado*. Montrose, CO: Western Reflections, 2002.

Whittemore, Loren R. *An Illustrated History of Ranching in the Pikes Peak Region*. Colorado Springs, CO: Gowdy Printcraft Press, 1990.

Electric Power Generation

"Acquisitions and Divestitures since 1939." Manuscript WH 1367, Box 1, Folder FF15, Denver Public Library. 1966.

Breckenridge Bulletin. Breckenridge, CO [various unpublished articles referenced by issue].

"Brief History of Public Service Company of Colorado." Manuscript WH 1367, Box 1, Folder FF7, Denver Public Library. 1931.

"Chicago Lake Reservoirs-Clear Creek County, Co." 1905 [on file at Colorado School of Mines].

"Colorado Power Company, Plant Information." Manuscript WH 1367, Box 1, Folder FF54, Denver Public Library. 1925.

Colorado Power Company. "General Description of Reservoirs, Pipe Lines, Generating Stations, and Substations and Transmission Lines" Manuscript WH 1367, Box 1, Folder FF55, Denver Public Library. 1920.

"Colorado Power Company Formed." Summit County Journal (6/23/03): 7.

"Comprehensive Plans of the Central Colorado Power Company." Eagle Valley Enterprise (9/27/07): 1.

"Corporate Organizations-Subsidiaries, Green & Clear Lakes Co." Manuscript WH 1367, Box 1, Folder FF69, Denver Public Library. 1939.

"Dates of Original Construction or Rebuilds." Manuscript WH 1367, Box 1, Folder FF13, Denver Public Library. 1938.

Electrical Power Plants and Distribution Systems, Colorado, 1974. Denver, CO: Colorado Land Use Commission, 1974.

"Electricity in the Clear Creek County (Colorado) Mines" Mining Reporter (1/16/02): 96.

Gambrill, Kenneth. The Shoshone Hydroelectric Plant Complex, Glenwood Canyon, Colorado. Denver, CO: Colorado Department of Highways, 1983.

Gidlund, H.F. "Public Service Co. of Colorado: History and Plant Information." Manuscript WH 1367, Box 1, Folder FF5, Denver Public Library. 1925.

"History of the Company." Manuscript WH 1367, Box 1, Folder FF10, Denver Public Library. 1935.

"History of Predecessor Companies, 1910-1924." Manuscript WH 1367, Box 1, Folder FF42, Denver Public Library. 1942.

"Hot, High and Powerful Voltage." Summit County Journal (7/24/09): 1.

McCrary, Irvin J. Development of Electric Power Industry in Colorado, 1916-1936. Denver, CO: Colorado State Planning Commission, 1938.

Robertson, Lawrence M. The Birth and Growth of Electricity in Colorado. 1982.

"Shoshone Plant in Operation." Eagle Valley Enterprise (5/21/09): 1.

"Shoshone Plant Turns on Water." Eagle Valley Enterprise (6/11/09): 4.

Tod, Jack H. Porcelain Insulators: Guide Book for Collectors. Phoenix, AZ: Jack Tod, 1971.

"Tunnel Twelve Miles Long." Summit County Journal (9/7/07): 7.

"United Hydro Electric Company - Colorado Power Company." Manuscript WH 1367, Box 1, Folder FF78, Denver Public Library, 1941.

U.S. Geological Survey. *Power Resources of Eagle River, Colorado, Eagle County*. U.S. Geological Survey, 1925 [on file at Colorado School of Mines, Golden, CO].

U.S. Geological Survey. *Power Resources of Roaring Fork of Colorado River, Colorado, Pitkin and Garfield Counties*. U.S. Geological Survey, 1925 [on file at Colorado School of Mines, Golden, CO].

U.S. Geological Survey. *Power Resources of Blue River, Colorado, Summit County*. U.S. Geological Survey, 1925 [on file at Colorado School of Mines, Golden, CO].

Railroad Transportation, General

Athearn, Robert G. *Rebel of the Rockies: The Denver & Rio Grande Western Railroad*. New Haven, CT: Yale University Press, 1962.

Beebe, Lucius and Clegg, Charles. *Narrow Gauge in the Rockies*. Berkeley, CA: Howell-North, 1958.

Beebe, Lucius and Clegg, Charles. *Rio Grande: Mainline of the Rockies*. Berkeley, CA: Howell-North, 1962.

Hill, Ronald C. *Rio Grande: Memories of the Final Years*. Golden, CO: Colorado Railroad Museum, 2007.

Jessen, Kenneth. *Railroads of Northern Colorado*. Boulder, CO: Pruett Publishing Company, 1982.

LeMassena, Robert A. *Rio Grande ... to the Pacific!* Denver, CO: Sundance Books, 1974.

LeMassena, Robert A. *Colorado's Mountain Railroads*. Denver, CO: Sundance Books, 1984.

Ormes, Robert. *Tracking Ghost Railroads in Colorado*. Colorado Springs, CO: Century One Press, 1975.

Railroad Transportation, Clear Creek County

Abbott, Dan. *Stairway to the Stars: Colorado's Argentine Central Railway*. Ft. Collins, CO: Centennial Publications, 1977.

Abbott, Dan, McCoy, Dell A., and McLeod, Robert W. *Colorado Central Railroad, Golden, Central City, Georgetown*. Denver, CO: Sundance Publications, 2007.

"An Important Mining Tunnel." *Mining & Scientific Press* (10/14/82): 241.

"Atlantic-Pacific." *Rocky Mountain Mining Review* (11/25/80): 11.

Griswold, P.R., Kindig, Richard H., and Trombly, Cynthia. *Georgetown and the Loop*. Denver, CO: Rocky Mountain Railroad Club, 1988.

Guide to the Georgetown Silver Plume Historic District. Cordillera Press, Inc., 1986.

Hauck, Cornelius W. *Narrow Gauge to Central and Silver Plume*. Golden, CO: Colorado Railroad Museum, 1979.

Morgan, Gary. *The Georgetown Loop: Colorado's Scenic Wonder*. Fort Collins, CO: Centennial Publications, 1976.

National Park Service. *Study of Alternatives: Georgetown-Silver Plume Historic District, Colorado*. United States Department of the Interior, 1989.

Railroad Transportation, Summit County

Chappell, Gordon S., Hauck, Cornelius W., and Richardson, Robert W. *Colorado Rail Annual No.12: The South Park Line, A Concise History*. Golden, CO: Colorado Railroad Museum, 1974.

Digerness, David S. *The Mineral Belt: Volume II, Old South Park, Across the Great Divide*. Denver, CO: Sundance Books, 1978.

Klinger, Tom and Klinger, Denise. *C&S High Line Memories, and then Some*. Lakewood, CO: Tom Klinger, 2004.

Poor, M.C. *Denver, South Park & Pacific*. Denver, CO: Rocky Mountain Railroad Club, 1976.

Osterwald, Doris B. *High Line to Leadville: A Mile by Mile Guide for the Leadville, Colorado & Southern Railroad*. Lakewood, CO: Western Guideways, 1991.

Road Transportation

A Policy on Geometric Design of Highways and Streets. Washington, D.C.: American Association of State Highway and Transportation Officials, 1937.

Burke, Marril Lee. *A Bumpy Ride: A History of Stagecoaching in Colorado*. Lake City, CO: Western Reflections Publishing Company, 2007.

Colorado Division of Highways. *The High Road*. Denver, 1990.

Colorado State Highway Commission. *Colorado Highways*. (5/1922).

The Frontenac Motor Company. *Ford Model T: Frequently Asked Questions*. May 31, 2011, <http://www.modelt.ca/faq-fs.html>.

Hauserman, Dick and Michael Thacker. *On the Road to Vail and Beyond*. Edwards, CO: Golden Peak Publishing Company, 2004.

Koucherik, Shannon. "Victory Highway." Museum of Northwest Colorado. December 2009, <http://www.museumnwco.org>.

Legends of America. "Colorado Legends: Central City Boom and Bust." December 2009, www.legendsofamerica.com.

Lewis, Tom. *Divided Highways: Building the Interstate Highways, Transforming American Life*. New York, NY: Penguin, 1997.

The Lincoln Highway. December 2009, <http://lincolnhighway.jameslin.name>.

"Midland Trail in Good Condition Now." *New York Times* (4/11/15).

Norman, Cathleen *Historic Contexts Report: 1999-2002 Cultural Resource Survey of Unincorporated Jefferson County* Lakewood, CO, 2002, Preservation Publishing.

Ridgway, Arthur. "The Mission of Colorado Toll Roads." *Colorado Magazine*. (9/1932) 161-9.

"Road Work Active on Midland Trail." *New York Times* (5/18/13).

Schader, Conrad. *Glenwood Canyon: From Origin to Interstate*. Golden, CO: Regio Alta Publications, 1996.

Scott, Glenn. *Historic Trail Map of the Denver Quadrangle, Central Colorado*. United States Geological Survey, 1999.

Scott, Glenn. *Historic Trail Map of the Leadville Quadrangle, Central Colorado*. Denver Public Library, Western History Department, 2004.

Sprague, Marshall. *The Great Gates: The Story of the Rocky Mountain Passes*. Boston, MA: Little, Brown, and Company, 1964.

Ubbelohde, Carl, Maxine Benson, Duane Smith. *A Colorado History* [9th Edition]. Boulder, CO: Pruett Publishing, 2006.

Wiley, Marion. *The High Road*. Denver, CO: Colorado Department of Highways, 1976, 26-7.

Winther, Oscar. *The Transportation Frontier: Trans-Mississippi West 1865-1890*. Chicago, IL: Holt, Rinehart, and Winston, 1964.

Wyckoff, William. *Creating Colorado: The Making of a Western American Landscape, 1860-1940*. New Haven, CT: Yale University Press, 1999.

Tourism and Recreation

Allen, Wayne L. "Big Men and Little Engines." *Historic Georgetown, Centennial Gazette 1868-1968*. Georgetown, CO: Georgetown Historical Society, 1968.

Aron, Cindy S. *Working at Play: A History of Vacations in the United States*. New York, NY: Oxford University Press, 2001.

Baker, Gayle. *Denver: A Boomtown History*. Santa Barbara, CO: Harbor Town Histories, 2004.

Belasco, Warren J. *Americans on the Road: From Autocamp to Motel, 1910-1945*. Cambridge, MA: MIT Press, 1979.

Borne, Lawrence R. *Dude Ranching: A Complete History*. Albuquerque, NM: University of New Mexico Press, 1983.

Bowland, Laverne. "History of the Hot Springs Hotel." *Tailings, Tracks, & Tommyknockers: History of Clear Creek County*. Denver, CO: Specialty Publishing Company, 1986.

Brockman, Christian Frank and Lawrence C. Merriam. *Recreational Use of Wild Lands*. New York, NY: McGraw Hill, 1979.

Carrington, Raye. *Pearl Lakes Trout Club, Inc.: A History*. Austin, TX: Self-published, 1990.

Chicago, Rock Island and Pacific Railway. *Colorado Cities and Places: Glenwood Springs, Cascade, Manitou, Green Mountain Falls, Denver, Buena Vista, Colorado Springs, Pueblo, Estes Park, Idaho Springs: Peaks, Parks, Canons, and Mountain Resorts*. Chicago, IL: National Journalist Press, 1890.

Cocks-Clark Engraving Company. *Western Colorado, the Playground of America: Mt. of the Holy Cross and the Eagle River Valley, Eagle County*. Denver, CO: Cocks-Clark Engraving Company [circa 1910 to 1919].

Coleman, Annie Gilbert. *Ski Style: Sport and Culture in the Rockies*. Lawrence, KS: University Press of Kansas, 2004.

Coleman, Annie Gilbert. *Ski Style: Sport and Culture in the Rockies*. Lawrence, KS, 2004, University Press of Kansas.

Colorado Dude Ranch Association. *Colorado Dude Ranches*. Pamphlet, 1949.

Colorado Midland Railway. *Hunting Fishing, Camping in the Colorado Rockies*. Denver, CO: Smith-Brooks Press [circa 1908].

Colorado Miner (6/8/71): 4.

Colorado Miner (1/15/76): 3.

Colorado Miner (7/15/76): 3.

Colorado Miner (5/12/87): 3.

Colorado Ski History. *Colorado's Lost Resorts*. July 7, 2009, <http://www.coloradoskihistory.com/lostresorts.html>.

Colorado State Advertising and Publicity Committee (APC). *Making the World Colorado Conscious: General Report, 1941-1946*. Denver, CO: APC, 1947.

Crampon, L.J. *The Tourist and Colorado*. Boulder, CO: U of Colorado, Bureau of Business Research, 1956.

Crampon, L.J. and Ronald D. Lemon. *Skiing in the Southern Rocky Mountain Area*. Boulder, CO: U of Colorado, Bureau of Business Research, circa 1957.

Draper, Ben. *History of the Mountain Parks*. Denver, CO: Federal Civil Works Administration, 1934.

Fay, Abbott. *A History of Skiing in Colorado*. Ouray, CO: Western Reflections, 2000.

Gilliland, Mary Ellen. *Frisco! A Colorful Colorado Community*. Silverthorne, CO: Alpenrose Press, 1984.

Gillette, Ethel Morrow. *Idaho Springs: Saratoga of the Rockies; A History of Idaho Springs, Colorado*. New York, NY: Vantage Press, 1978.

Georgetown Loop Railroad. *Georgetown Loop Railroad History*. http://www.georgetownlooprr.com/about_us/history.shtml.

Grabau, Alison. *Summit Pioneers*. The Summit Foundation, 1999.

Gulliford, Andrew. *Garfield County, Colorado: The First Hundred Years, 1883-1983*. Glenwood Springs, CO: Gran Farnum Printing, 1983.

Guilfoyle, David R., Horn, Jonathan C., and Neely, Burr. "Recreation." *Colorado History: A Context for Historical Archaeology*. Denver, CO: Colorado Council of Professional Archaeologists, 2007.

Hauk, Paul. *A-Basin Ski Area Chronology*. Glenwood Springs, CO: U.S. Forest Service, White River National Forest, 1979(a).

Hauk, Paul. *Keystone Ski Area Chronology*. Glenwood Springs, CO: U.S. Forest Service, White River National Forest, 1979(b).

Hauk, Paul. *Beaver Creek Ski Area Chronology*. Glenwood Springs, CO: U.S. Forest Service, White River National Forest, 1979(c).

Hauk, Paul. *Copper Mountain Ski Area Chronology*. Glenwood Springs, CO: U.S. Forest Service, White River National Forest, 1979(d).

Hauk, Paul. *Vail Ski Area Chronology*. Glenwood Springs, CO: U.S. Forest Service, White River National Forest, 1979(e).

Helphand, Kenneth I. *Colorado: Visions of an American Landscape*. Niwot, CO: Roberts Rinehart Publishers, 1991.

Jensen, Clayne and Steven Guthrie. *Outdoor Recreation in America, 6th Edition*. Champaign, IL: Human Kinetics, 2006.

Kansas Pacific Railway Company. *Colorado, Its Resorts and Attractions to the Pleasure-Seeker, Tourist, and Invalid*. Kansas City, MO: Kansas Pacific Railway Company, 1873.

Knight, MacDonald, and Leonard Hammock. *Early Days on the Eagle*. Eagle, CO: 1965.

Lears, J. Jackson. *No Place of Grace: Antimodernism and the Transformation of American Culture, 1880-1920*. Chicago, IL: University of Chicago Press, 1994.

Lvfgrén, Orvar. *On Holiday: A History of Vacationing*. Ewing, N.J.: University of California Press, 1999.

Mather, Sandra F. and Summit Historical Society. *Images of America: Summit County*. Charleston, SC: Arcadia Publishing, 2008.

McCabe, William. *The Empire of the Eagle: A Descriptive History of a Great County*. Red Cliff, CO: Red Cliff Publisher, 1899.

Nelson, Jim. *Glenwood Springs: The History of a Rocky Mountain Resort*. Ouray, CO: Western Reflections Publishing, 1999.

“New Tourist Camp.” *Georgetown Courier* (7/23/27): 1.

Page, Charles A. *Rocky Mountain Fish Tails*. Gunnison, CO: Page Books, 1975.

Peck House. *Peck House History*. March 5, 2010, <http://www.thepeckhouse.com/history.htm>.

Philpott, William. *Consuming Colorado: Landscapes, Leisure, and the Tourist Way of Life*. Ph.D. Dissertation, University of Wisconsin at Madison, 2002.

Robertson, Jan, Jay Fell, Walt Borneman and Chris Case. *100 Years Up High: Colorado Mountains and Mountaineers*. Golden, CO: Colorado Mountain Club Press, 2011.

Schader, Conrad F. *Glenwood Canyon: From Origin to Interstate*. Golden, CO: Regio Alta Publications, 1996.

St. Louis, Kansas City and Northern Railway Company. *The Famous Rocky Mountain Resorts in Colorado and How to Reach Them (Season of 1877)*. St. Louis, MO: Levinson and Blythe, 1877.

Terrie, P.G. *Contested Terrain: A New History of Nature and People in the Adirondacks*. Syracuse, NY: The Adirondack Museum/Syracuse University Press, 1997.

U.S. Forest Service *Forest Trails Handbook* U.S. Department of Agriculture, U.S. Forest Service, 1935.

U.S. Forest Service. *National Forest Vacations*. Pamphlet, U.S. Government Printing Service, 1940.

Wickstrom, Gordon M. *Notes From and Old Fly Book*. Boulder, CO: University Press of Colorado, 2001.

Wolf, Tom. *Arthur Carhart: Wilderness Prophet*. Boulder, CO: University Press of Colorado, 2008.

Wyckoff, William. *Creating Colorado: the Making of a Western American Landscape, 1860-1940*. New Haven, CT: Yale University Press, 1999.

Historic Contexts and Preservation Publications

Autabee, Robert and Deborah Dobson-Brown. *Colorado State Roads and Highways: National Register of Historic Places Multiple Property Submission*. Denver, CO: Colorado State Historic Preservation Office, Colorado Historical Society, (draft) 2003.

Associated Cultural Resource Experts. *Highways to the Sky: A Context and History of Colorado's Highway System*. Lakewood, CO: Colorado Department of Transportation, 2002.

Boland, Beth Grosvenor. *National Register Bulletin: Guidelines for Evaluating and Documenting Properties Associated with Significant Persons*. National Park Service.

Federal Highway Administration and Colorado Department of Transportation. *I-70 Mountain Corridor Draft Programmatic Environmental Impact Statement Section 4(f) Evaluation*. November 17, 2004.

Federal Highway Administration and Colorado Department of Transportation. *Revised Reconnaissance Survey of the Interstate 70 Mountain Corridor Between Glenwood Springs and C-470 in Colorado*. 2005.

Fell, Jay and Twitty, Eric. *The Mining Industry in Colorado Multiple Property Documentation Form*. Denver, CO: Colorado State Historic Preservation Office, Colorado Historical Society, 2008.

Front Range Research Associates. *National Register of Historic Places, Multiple Property Documentation Form: Historic Farms and Ranches of Weld County*. Denver, CO: Front Range Research Associates, 1991.

Fraser, Clayton. *Railroads in Colorado, 1858-1949: Multiple Property Submission*. Denver, CO: Colorado State Historic Preservation Office, Colorado Historical Society, 1997.

Fraser, Clayton. *Highway Bridges in Colorado: Multiple Property Submission*. Denver, CO: Colorado State Historic Preservation Office, Colorado Historical Society, 2000.

Hardesty, Donald. *The Archaeology of Mining and Miners: A View from the Silver State*. Society for Historical Archaeology, 1988.

Hartley, Ralph and Schneck, James. *Administering the National Forests of Colorado: Assessing the Architectural and Cultural Significance of Historical Administrative Properties*. Lincoln, NE: U.S. Forest Service, Midwest Archaeological Center, 1996.

History Colorado. *OAHF: WPA Rustic*. May 31, 2011, <http://www.historycolorado.org/oahp/wpa-rustic>.

Keller, J. Timothy; Keller, Genevieve P.; and Land and Community Associates. *National Register Bulletin 18: How to Evaluate and Nominate Designed Historic Landscapes*. National Park Service, n.d.

King, Joseph. *Colorado Engineering Context*. Denver, CO: Colorado Historical Society, 1984.

Little, Barbara, Seibert, Erika Martin, Townsend, Jan, Sprinkle, John H., and Knoerl, John. *National Register Bulletin: Guidelines for Registering Archaeological Properties*. National Park Service, 2000.

McClelland, Linda Flint, Keller, J. Timothy, Keller, Genevieve P., and Melnick, Robert Z. *National Register Bulletin: Guidelines for Evaluating and Documenting Rural Historic Landscapes*. National Park Service, 1999 [1989].

Mehls, Steven. *Colorado Mountains Historic Context*. Denver, CO: Colorado Historical Society, 1984.

Messick, Denise P., Joseph, J.W., and Adams, Natalie P. *Tilling the Earth: Georgia's Historic Agricultural Heritage, A Context*. Stone Mountain, GA: New South Associates, 2001.

National Register Bulletin: Guidelines for Evaluating and Documenting Rural Historic Landscapes. National Park Service, 1999 [1989].

National Register Bulletin: How to Complete the National Register Multiple Property Documentation Form. National Park Service, 1999 [1991].

National Register Bulletin 15: How to Apply the National Register Criteria for Evaluation. National Park Service, 1991 [1990].

National Register Bulletin 16A: How to Complete the National Register Registration Form. National Park Service, 1997 [1977].

Noble, Jr., Bruce J. and Spude, Robert. National Register Bulletin 42: Guidelines for Identifying, Evaluating, and Registering Historic Mining Properties. National Park Service, 1992.

Noble, Jr., Bruce J. "Reflections on Previous Ruminations: Some Thoughts about Mining Site Eligibility and National Register Bulletin 42." Cultural Resource Management (8/3/08): 13-14.

Norman, Cathleen. Historic Contexts Report: 1999-2002 Cultural Resource Survey of Unincorporated Jefferson County. Lakewood, CO: Preservation Publishing, 2002.

Office of Archaeology and Historic Preservation. The New Deal in Colorado 1933-1942: Properties Listed in the National Register of Historic Places or the Colorado State Register. Denver, CO: Colorado Historical Society, 2008.

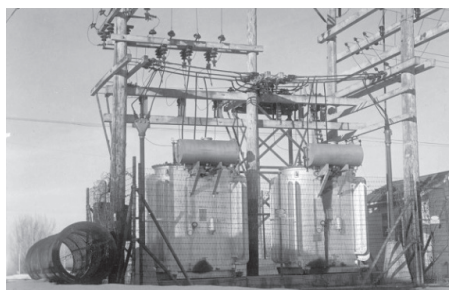
Simmons, Laurie R. and Simmons, Thomas H. National Register of Historic Places, Multiple Property Documentation Form: Historic Ranching Resources of South Park, Colorado. Denver, CO: Front Range Research Associates, 1999.

State Register Bulletin: How to Apply the Nomination Criteria for the Colorado State Register of Historic Properties. Denver, CO: Office of Archaeology and Historic Preservation, 2000.

Townsend, Jan, Sprinkle, John H., and Knoerl, John. National Register Bulletin: Guidelines for Evaluating and Registering Historical Archaeological Sites and Districts. National Park Service, 1999 [1993].

Twitty, Eric. Amendment to Metal Mining and Tourist Era Resources of Boulder County: Multiple Property Listing. Boulder, CO: Mountain States Historical, 2006.

Twitty, Eric Historic Mining Resources of San Juan County, Colorado Multiple Property Documentation Form Denver: Office of Archaeology and Historic Preservation, Colorado Historical Society, 2010.



SECTION F: ILLUSTRATIONS

Section F includes supporting illustrations referred to in the rest of the document. For consistency, the contents of Section F feature the same headings and subheadings as in the document’s other sections.

SECTION A: STATEMENT OF HISTORIC CONTEXTS



Illustration A 1: Overview map of the I-70 Mountain Corridor. I-70 appears as a double line with interstate placard, traversing east-west across the map bottom. The name Golden at right approximates the corridor’s eastern end, and Glenwood Springs at left the western end. Source: National Geographic TOPO! digital map (on CD).

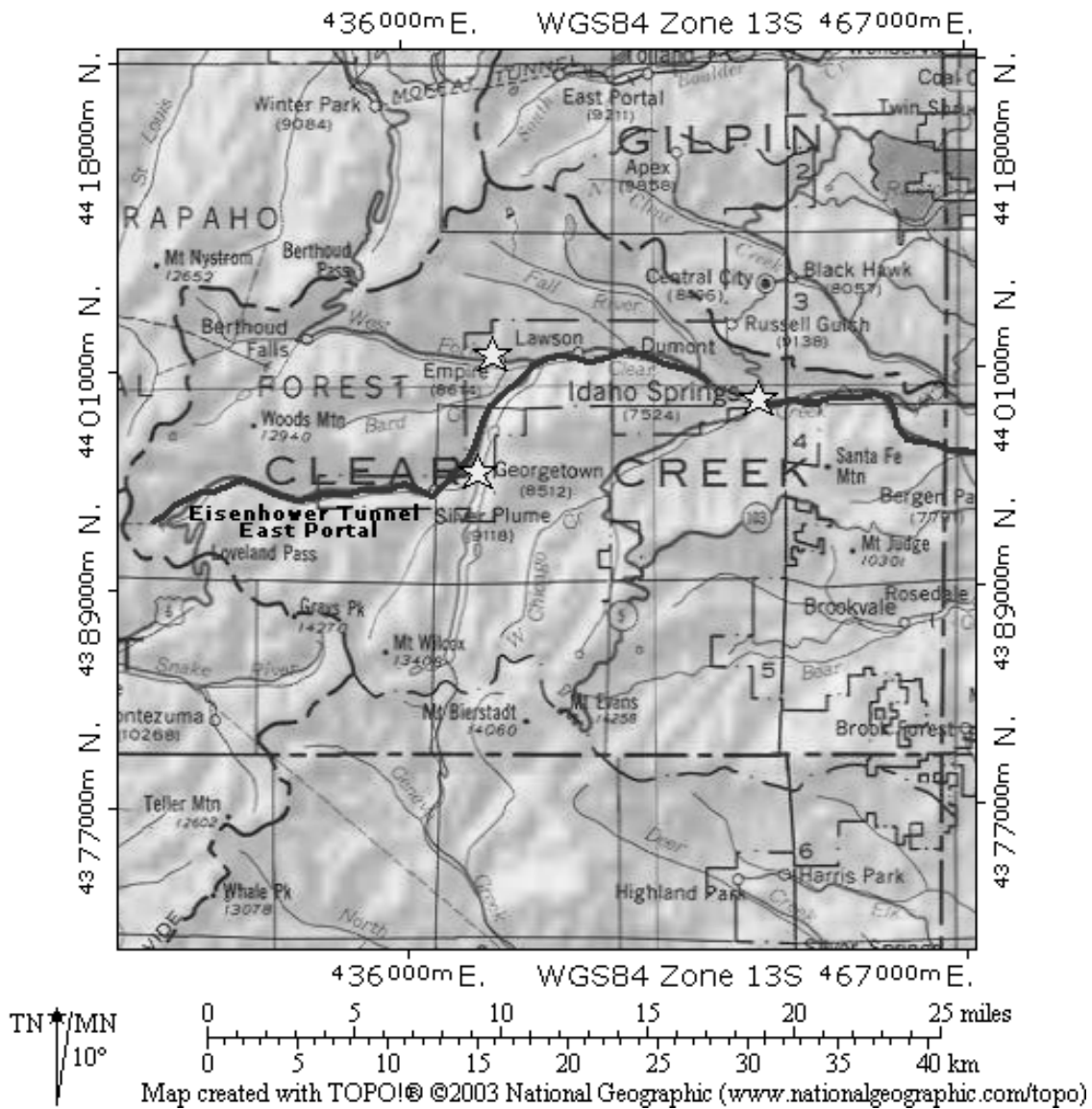


Illustration A 2: The map provides an overview of the I-70 Mountain Corridor in Clear Creek drainage, as well as the Clear Creek County boundary (dashed line). Idaho Springs is in the eastern portion, the Eisenhower Tunnel at the west edge, and Georgetown near center. The dark line is I-70. U.S. Highway 40 extends west from Empire, above Georgetown, and U.S. Highway 6 crosses Loveland Pass at the map’s west edge. Source: National Geographic TOPO! digital map (on CD).

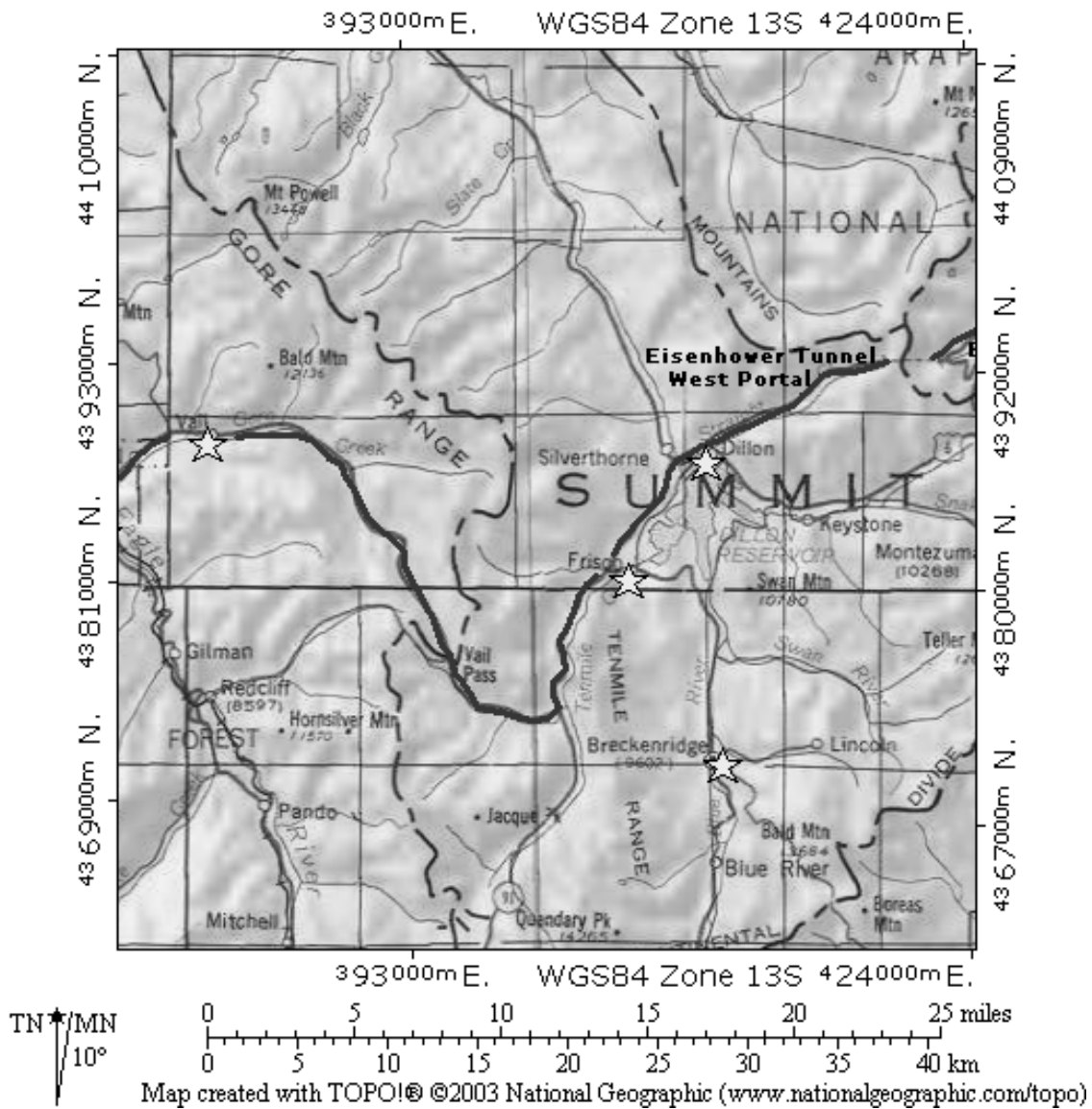


Illustration A 3: The map illustrates the I-70 corridor segment passing through Summit County. I-70 descends southwest down Straight Creek from Eisenhower Tunnel at upper right, passing by Dillon and Dillon Reservoir on north-flowing Blue River. The highway continues from Frisco south up Ten Mile Canyon, veers west, and crosses Vail Pass at center. Vail is on I-70 at the map’s left edge. Source: National Geographic TOPO! digital map (on CD).

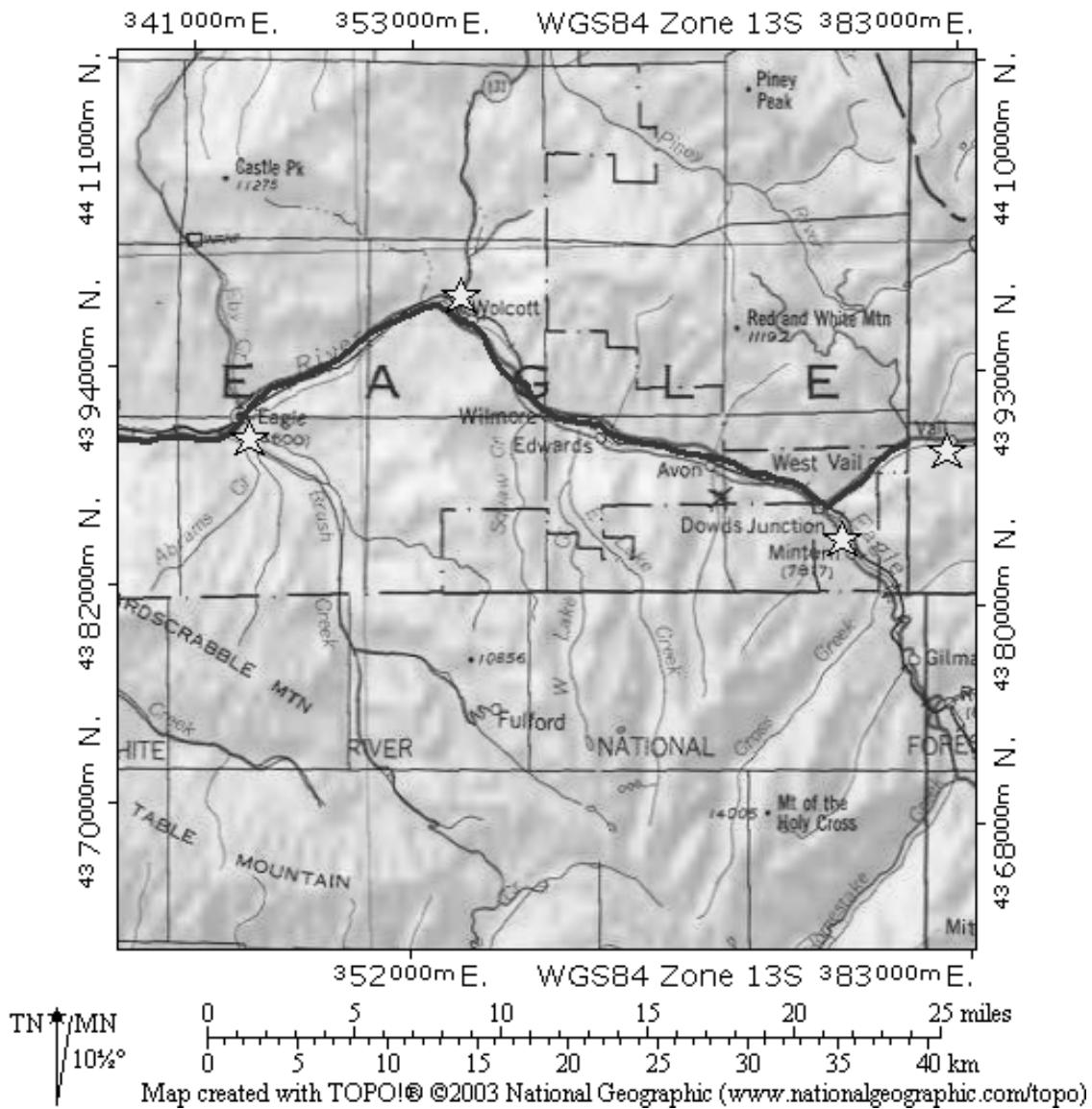


Illustration A 4: In the above map, I-70 descends west from Vail to Dowd’s Junction and Minturn, where it joins the Eagle River. I-70 follows the Eagle left and off the map, continued below. Source: National Geographic TOPO! digital map (on CD).

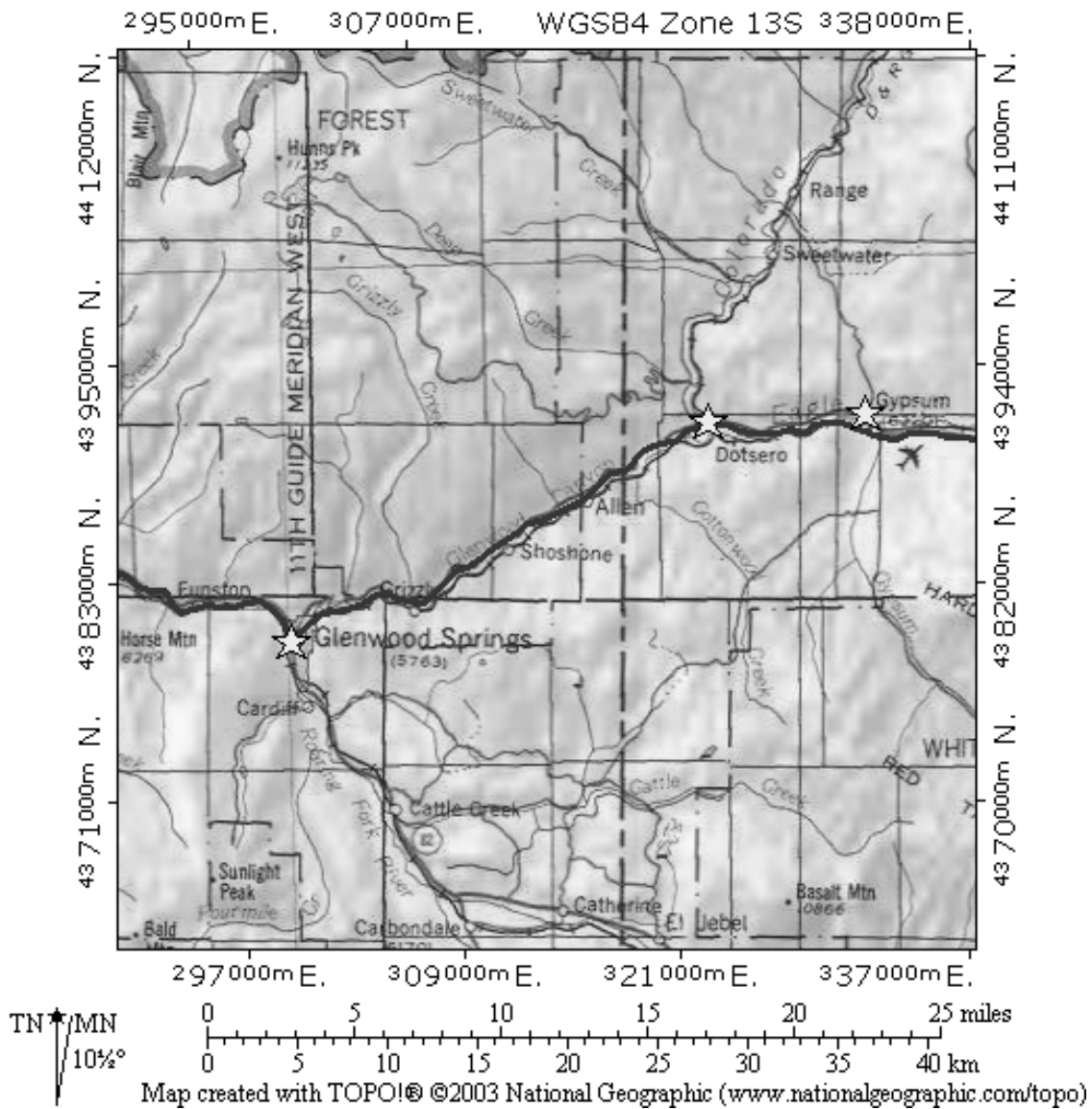


Illustration A 5: In the map, continued from above, I-70 follows the Eagle River to Dotsero, at the confluence with the Colorado River. I-70 parallels the Colorado, entering restricted Glenwood Canyon at Allen, center, and emerging at Glenwood Springs, the corridor’s western end. Source: National Geographic TOPO! digital map (on CD).

Section A 1.2: History of Mining in Clear Creek Drainage, 1859-1942**Discovery and the Placer Boom, 1859-1864**

Illustration A 1.2.1: A lone placer miner pans for gold at the mouth of Chicago Creek where prospector George Jackson first found placer deposits in 1859. Jackson's discovery began the gold rush to Clear Creek drainage, laying groundwork for what became one of Colorado's most important mining industries. Settlement, transportation systems, and dependent industries then followed. Although the miner and his camp are typical of prospecting during the 1860s, the photo dates to the 1890s. Courtesy of Denver Public Library, MCC-367.

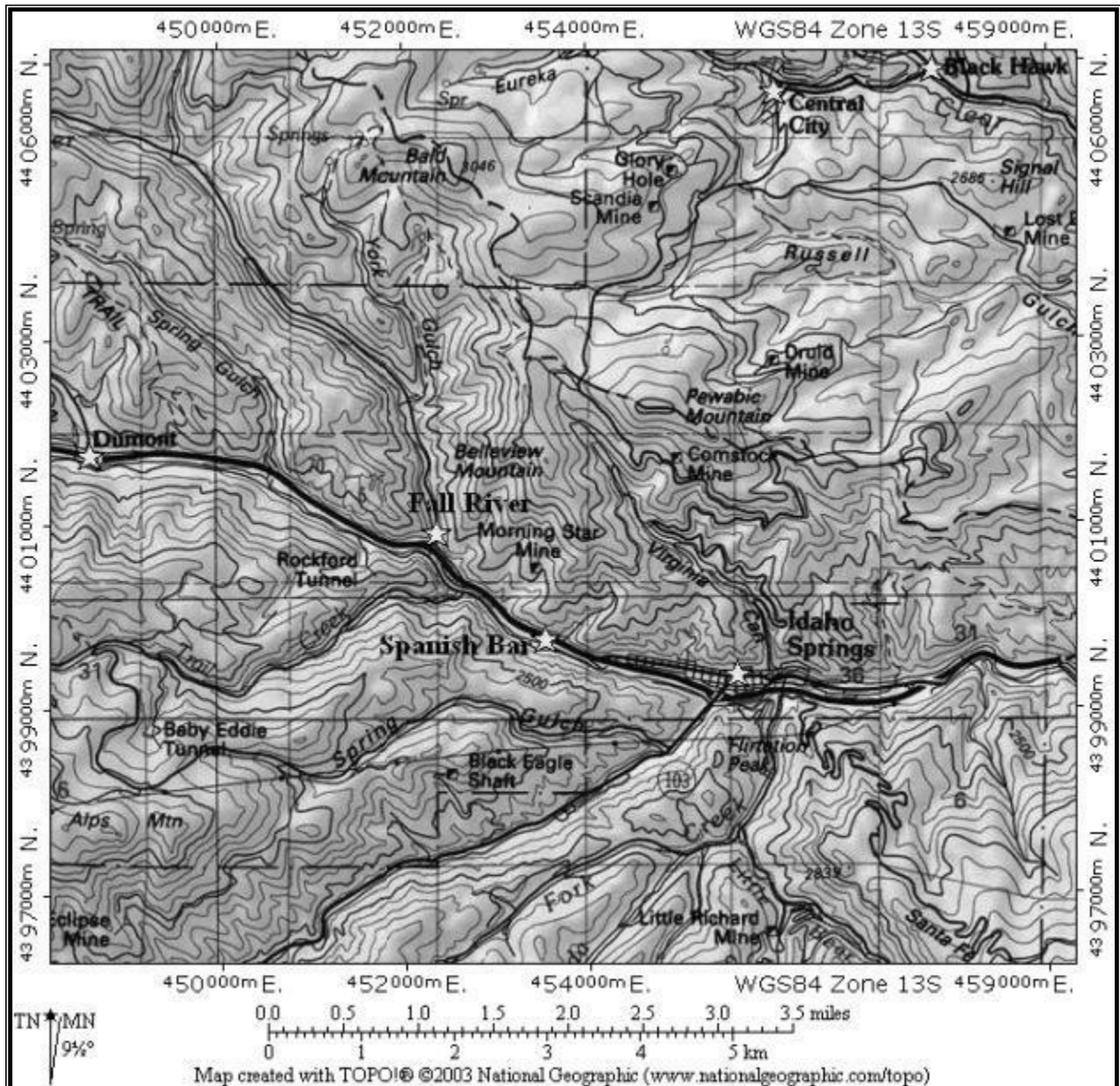


Illustration A 1.2.2: The map illustrates principal placer mining settlements (stars) in eastern Clear Creek drainage 1859-1865. The dark line is I-70, ascending west along Clear Creek from Idaho Springs past Dumont, originally Mill City. Chicago Creek ascends southwest from Idaho Springs, and Fall River northwest from Fall River. All the drainages were worked for placer gold during the period, and mines named on the map are later hardrock operations. Central City and Black Hawk are at upper right for reference. Source: National Geographic TOPO! digital map (on CD).

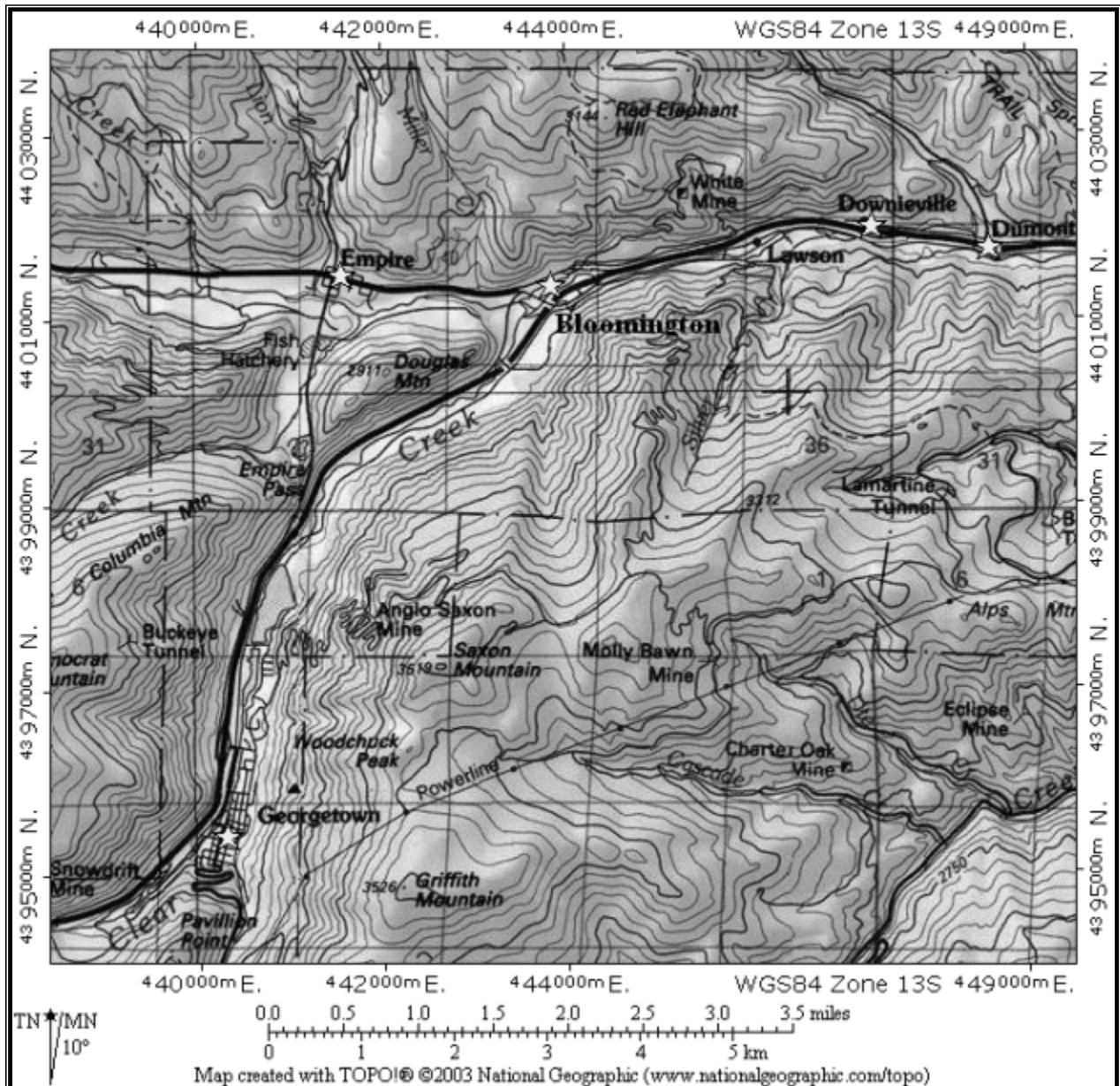


Illustration A 1.2.3: The map illustrates the principal placer mining settlements (stars) in western Clear Creek drainage 1859 to 1865. The dark line is I-70, ascending west along Clear Creek from Dumont past Georgetown, originally George's Town. The West Fork of Clear Creek ascends west from Empire, the Main Fork west from Georgetown, and the South Fork south from Georgetown. Very little placer gold was found west of the map boundary. Named mines were silver operations developed during the 1870s and later. Source: National Geographic TOPO! digital map (on CD).



Illustration A 1.2.4: Idaho Springs, originally known as Idahoe, became the most important town in eastern Clear Creek drainage during the 1860s. When this west view was captured in mid-decade, the hamlet was in transition from placer to hardrock mining. Because neither industry was ready to support major growth at the time, the town remained small. Courtesy of Denver Public Library, X-2243.

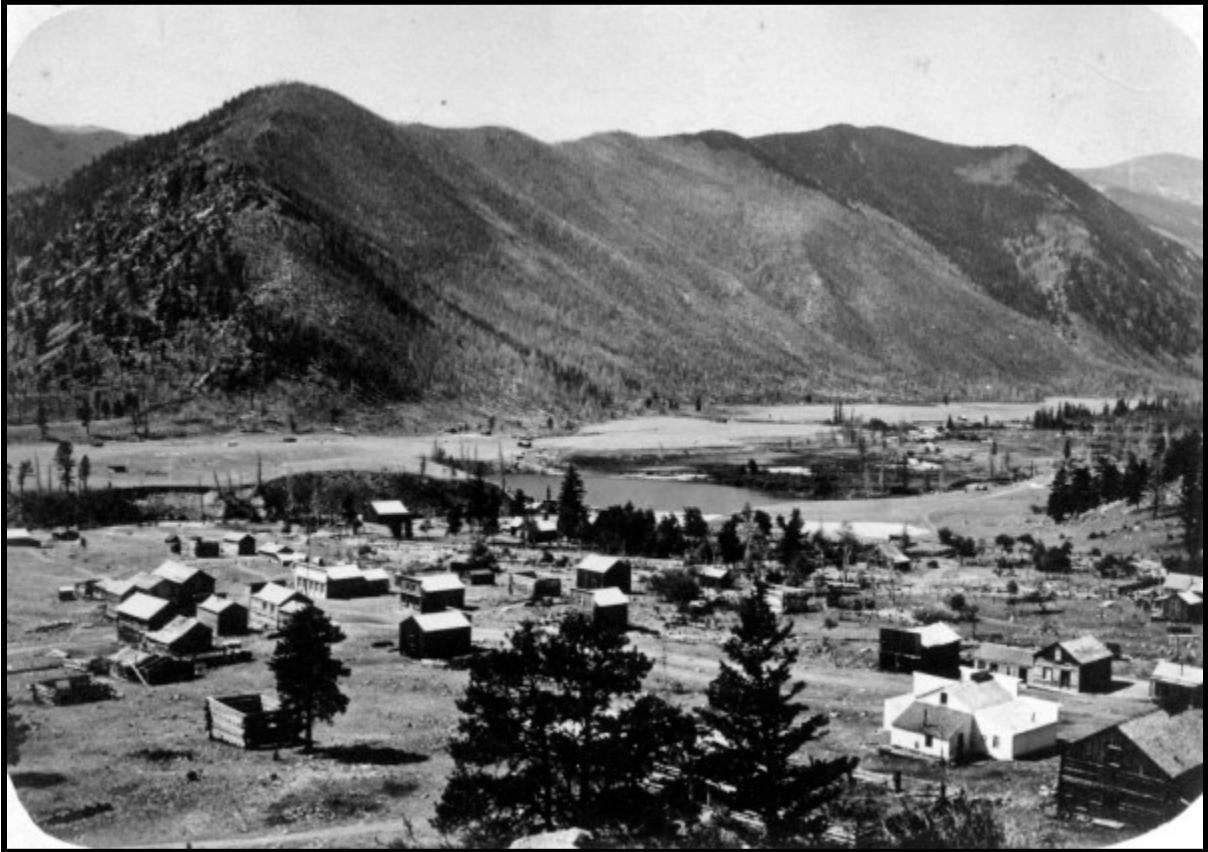


Illustration A 1.2.5: Empire boomed in this 1864 George D. Wakely photo, rivaling Idaho Springs as a center of gold production. While placer mining declined and hardrock mining developed slowly elsewhere in the drainage, both were highly productive at Empire into the late 1860s. Courtesy of Denver Public Library, X-8180.

Silver Boom in the Western Drainage, 1865-1874

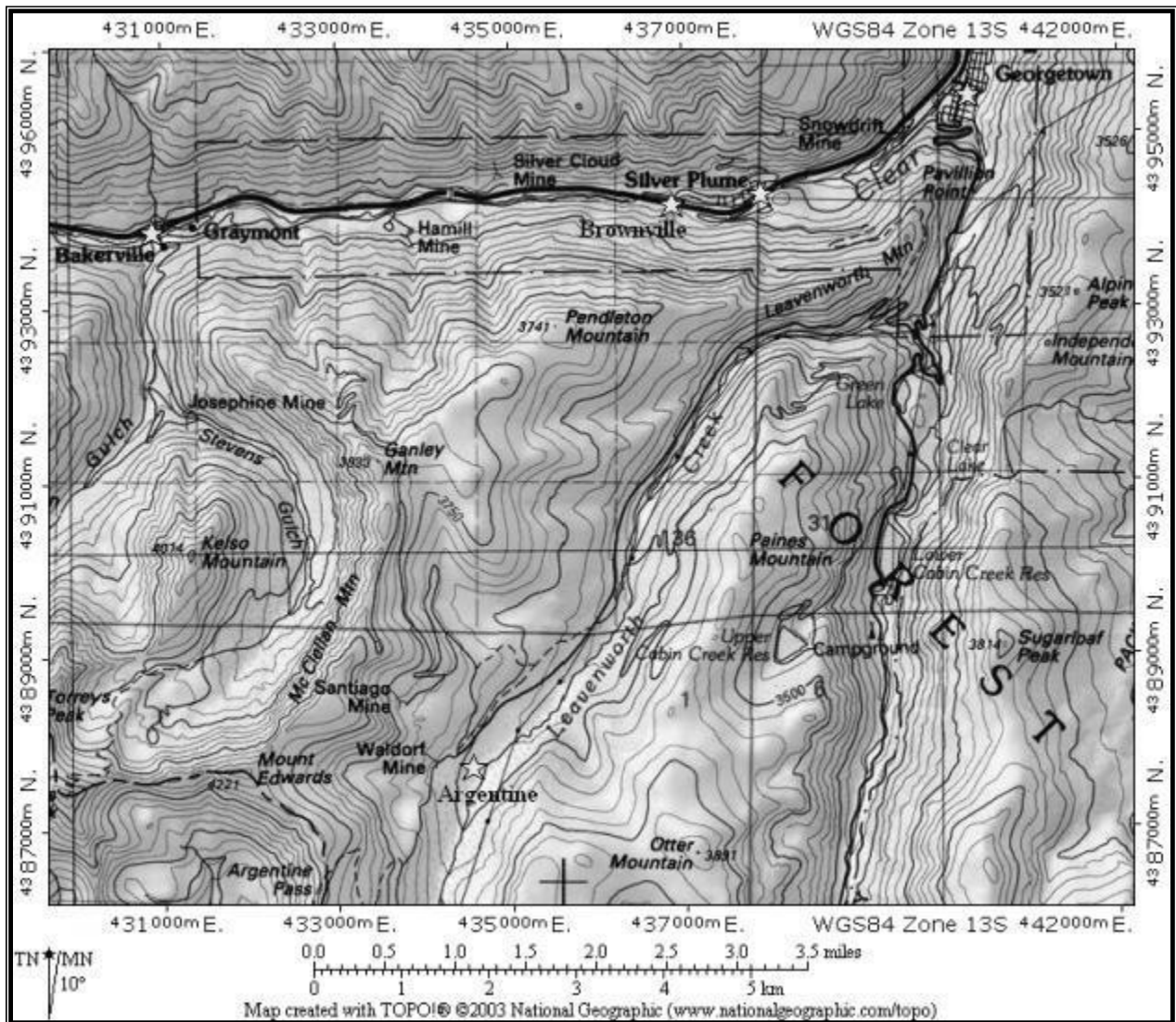


Illustration A 1.2.6: The map illustrates the principal geographic places associated with western Clear Creek drainage’s silver rush, 1865-1874. The dark line at top is I-70, ascending west along the Main Fork of Clear Creek. Argentine, site of the initial silver rush, is at lower left. Source: National Geographic TOPO! digital map (on CD).

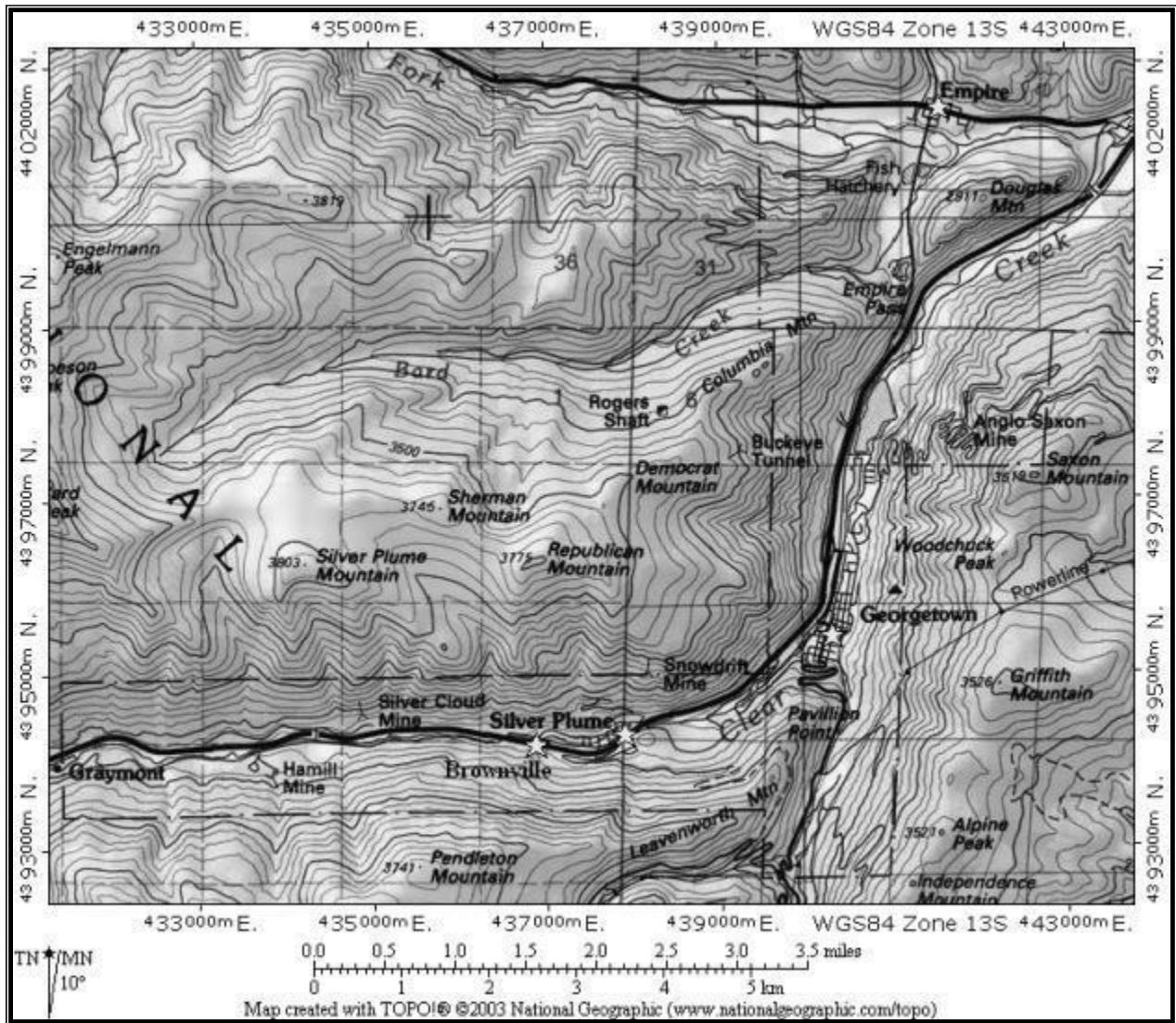


Illustration A 1.2.7: The map illustrates the principal landforms and mountains associated with the silver boom around Georgetown and Silver Plume, 1865-1893. The dark line following the Main Fork of Clear Creek is I-70. Bard Creek marks the northern extent of rich silver deposits, Graymont the western edge, and Griffith Mountain the eastern end. Source: National Geographic TOPO! digital map (on CD).

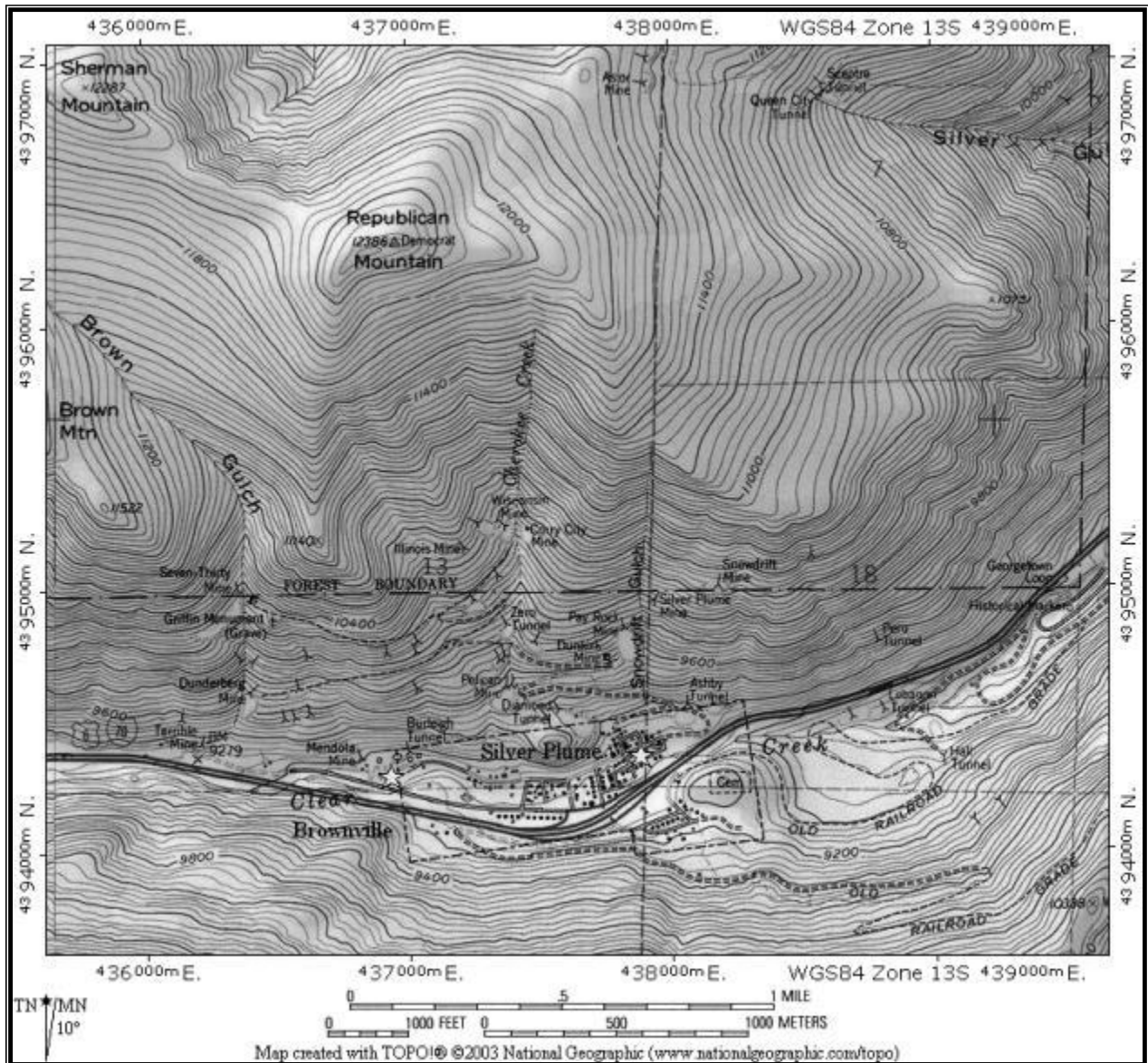


Illustration A 1.2.8: The map illustrates the principal mines above Silver Plume, producing millions of dollars in silver. Georgetown and Leavenworth Mountain are a short distance east off the map. Source: National Geographic TOPO! digital map (on CD).

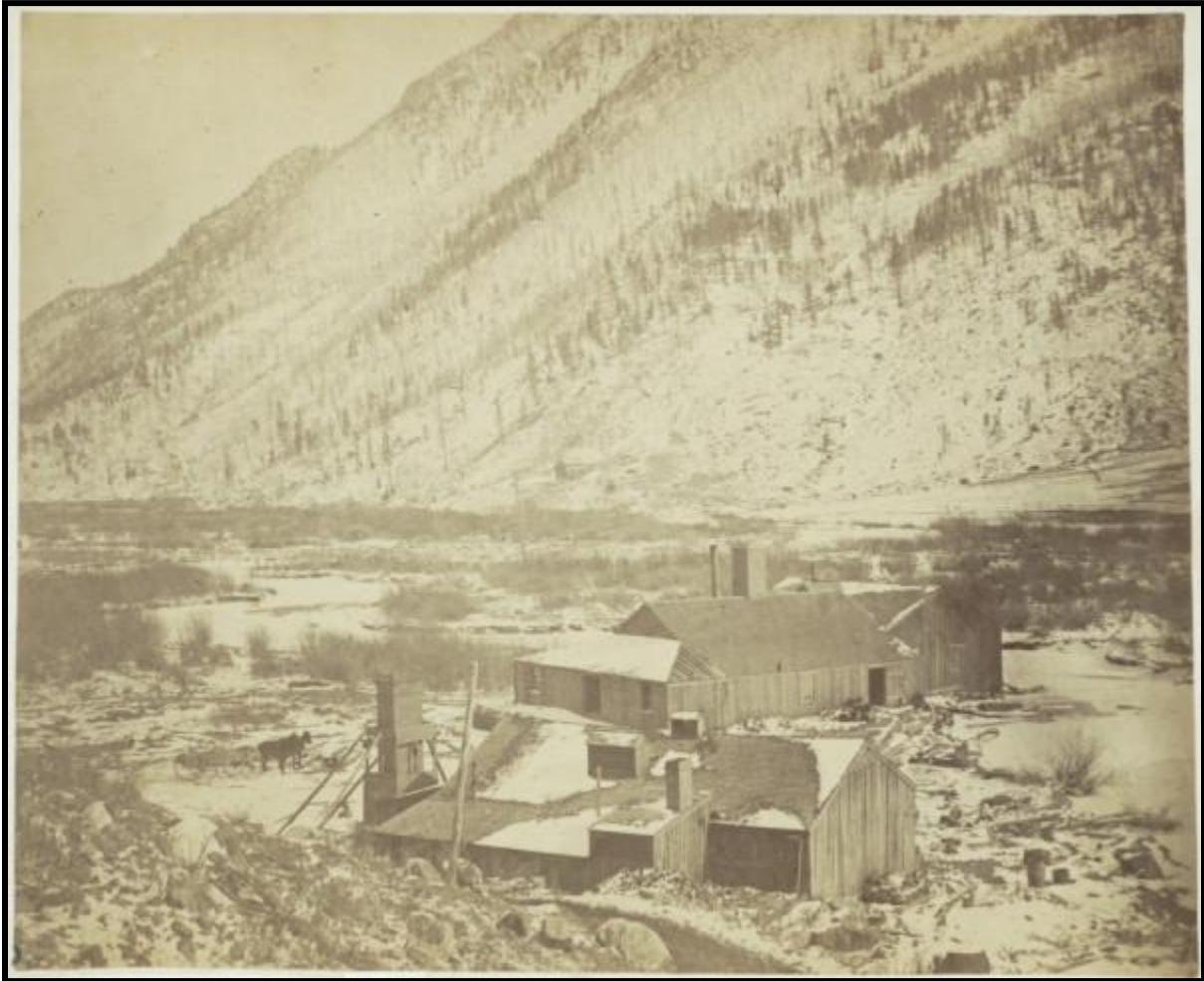


Illustration A 1.2.9: The eastern view, captured by Arundel C. Hull in 1867, illustrates the Stewart Reduction Works, which revolutionized mining in western Clear Creek drainage as the first successful silver smelter. The plant not only provided necessary ore treatment for local mining companies, but also set a precedent for similar facilities. Smelting, the only means of converting silver ore into a profitable commodity, allowed the western drainage to boom. Courtesy of Denver Public Library, Z-5765.



Illustration A 1.2.10: The Burleigh Tunnel was among the most important operations in western Clear Creek drainage during the late 1860s and early 1870s. Not only was the tunnel a major capital investment, but also proved that the ore veins around Silver Plume held value at depth, which many investors began to question at the time. Further, Charles Burleigh pioneered the use of rockdrills for drilling blast-holes underground, which revolutionized the greater mining industry in later decades. George Dalgleish took this north view during the 1880s. Courtesy of Denver Public Library, X-61687.

Silver Mining in the Western Drainage, 1875–1893

Illustration A 1.2.11: Silver Plume, an industrial mining town, reached peak production during the late 1870s and early 1880s. The town was wedged onto the valley floor at the toe of several mountains dotted with mines, employing hundreds. The view is north. George Dalgleish took this north view during the 1880s. Courtesy of Denver Public Library, X-2172.



Illustration A 1.2.12: The Seven-Thirty Mine was typical of Silver Plume's numerous silver producers. The mine was a tunnel operation with massive waste rock dump piled on a steep mountainside. Several times, these dumps gave way and cascaded onto buildings in town below. When this northwest view was taken during the 1890s, little had changed. Source: Spurr, 1908.



Illustration A 1.2.13: In contrast to working-class Silver Plume, Georgetown was a center of culture, sophistication, and mining elite. Louis Dupuy's Hotel de Paris was celebrated for its luxurious accommodations, dining, and cellar of imported European wines. George Dagleish took this north view during the 1890s. Courtesy of Denver Public Library, X4557.

Gold Mining in the Eastern Drainage, 1875-1893

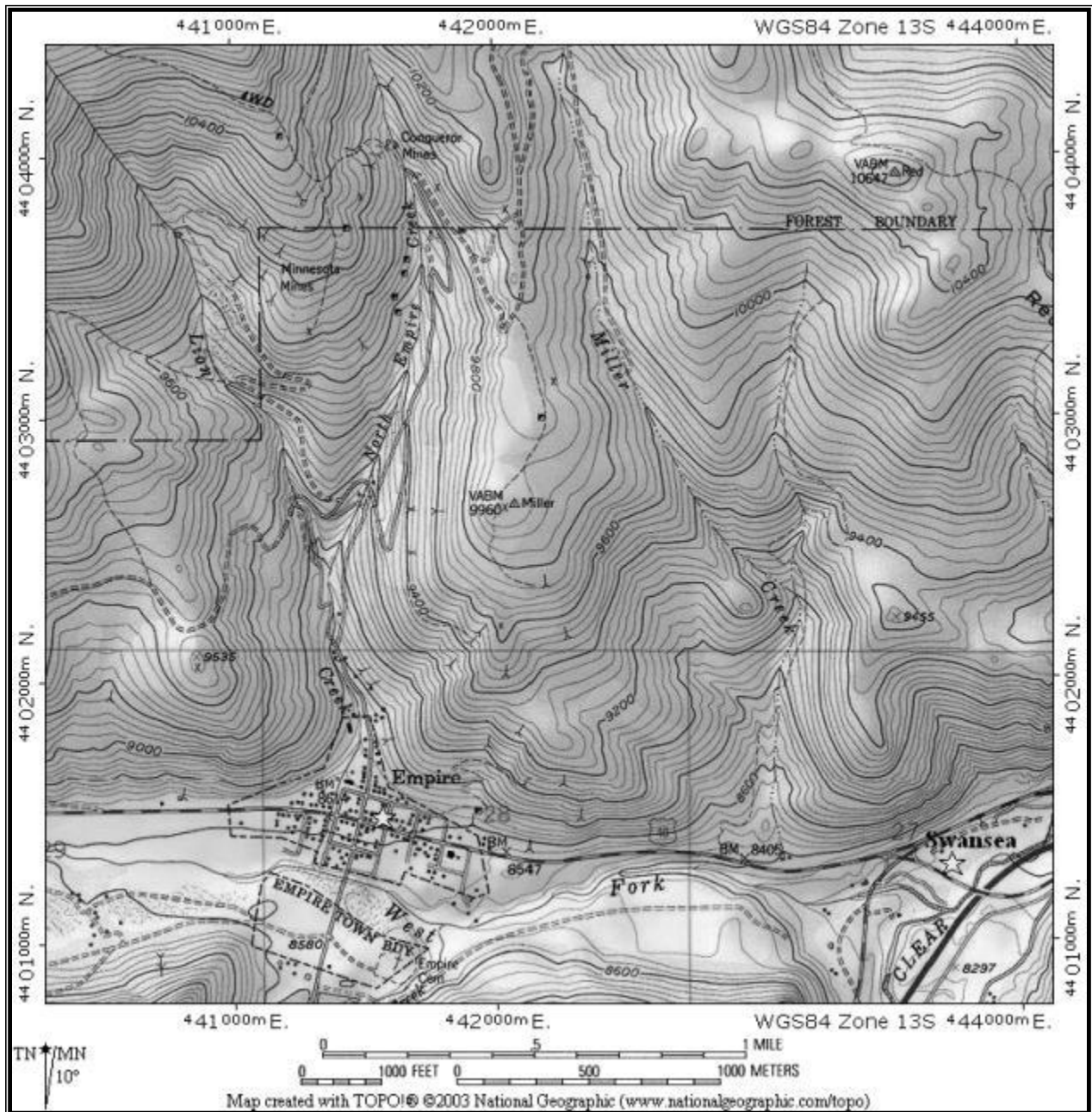


Illustration A 1.2.14: The map illustrates the principal area of mining above Empire, producing millions of dollars in gold and silver. Many mines are not shown and most are unnamed. Swansea and I-70 are at lower right. Source: National Geographic TOPO! digital map (on CD).

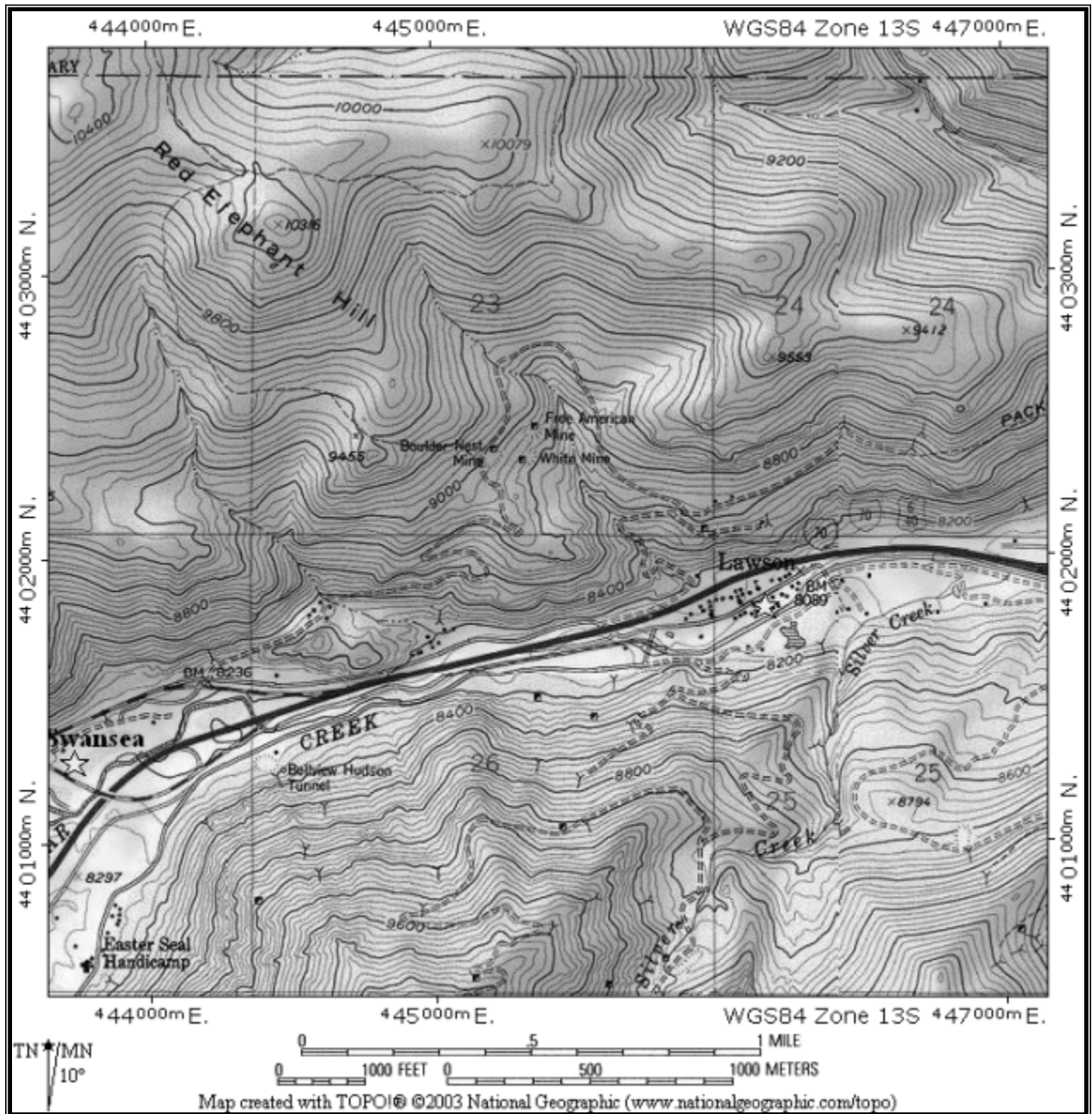


Illustration A 1.2.15: Red Elephant Hill was site of a localized gold rush, giving rise to Lawson. Silver Creek, a center of silver mining, is south. Many mines are not shown and most are unnamed. I-70 follows Clear Creek. Source: National Geographic TOPO! digital map (on CD).

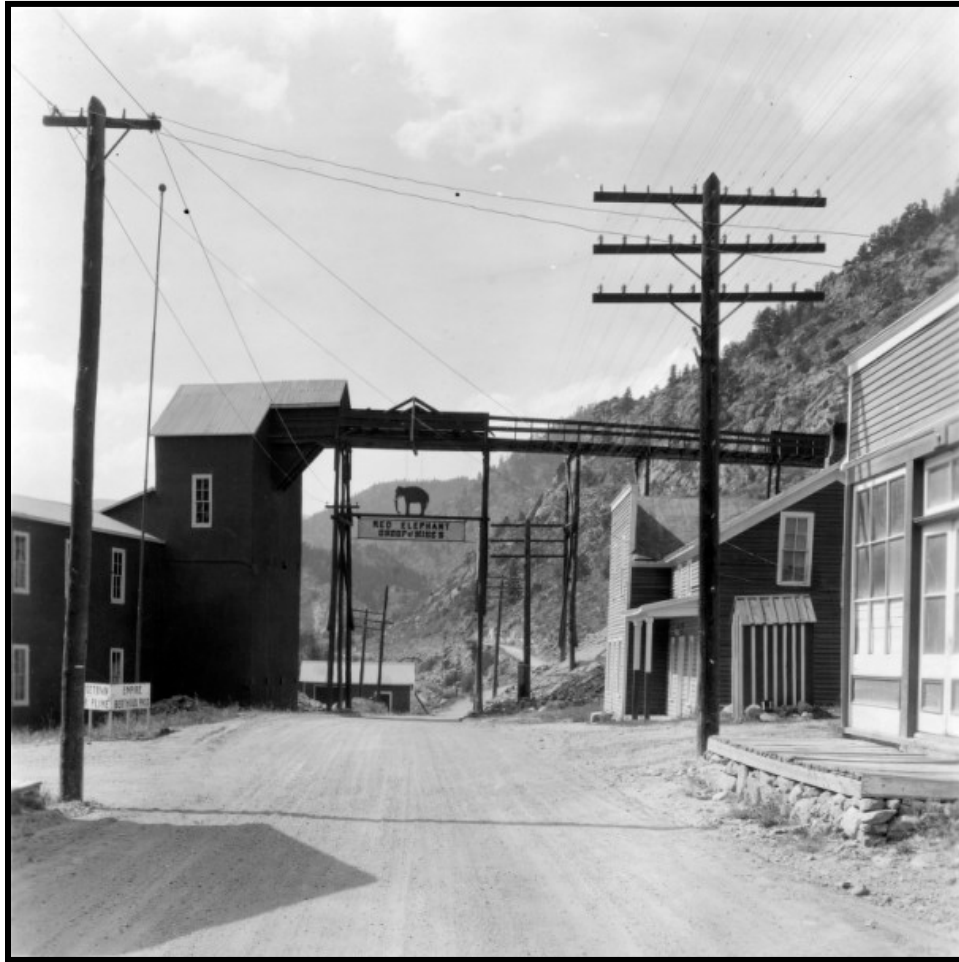


Illustration A 1.2.16: Discovery and development of the Red Elephant mines gave rise to Lawson, whose main street featured a combination of businesses and industrial structures. Although the photo dates to the 1910s, the mill at left was one of two erected by around 1880. Courtesy of Denver Public Library, X-61585.

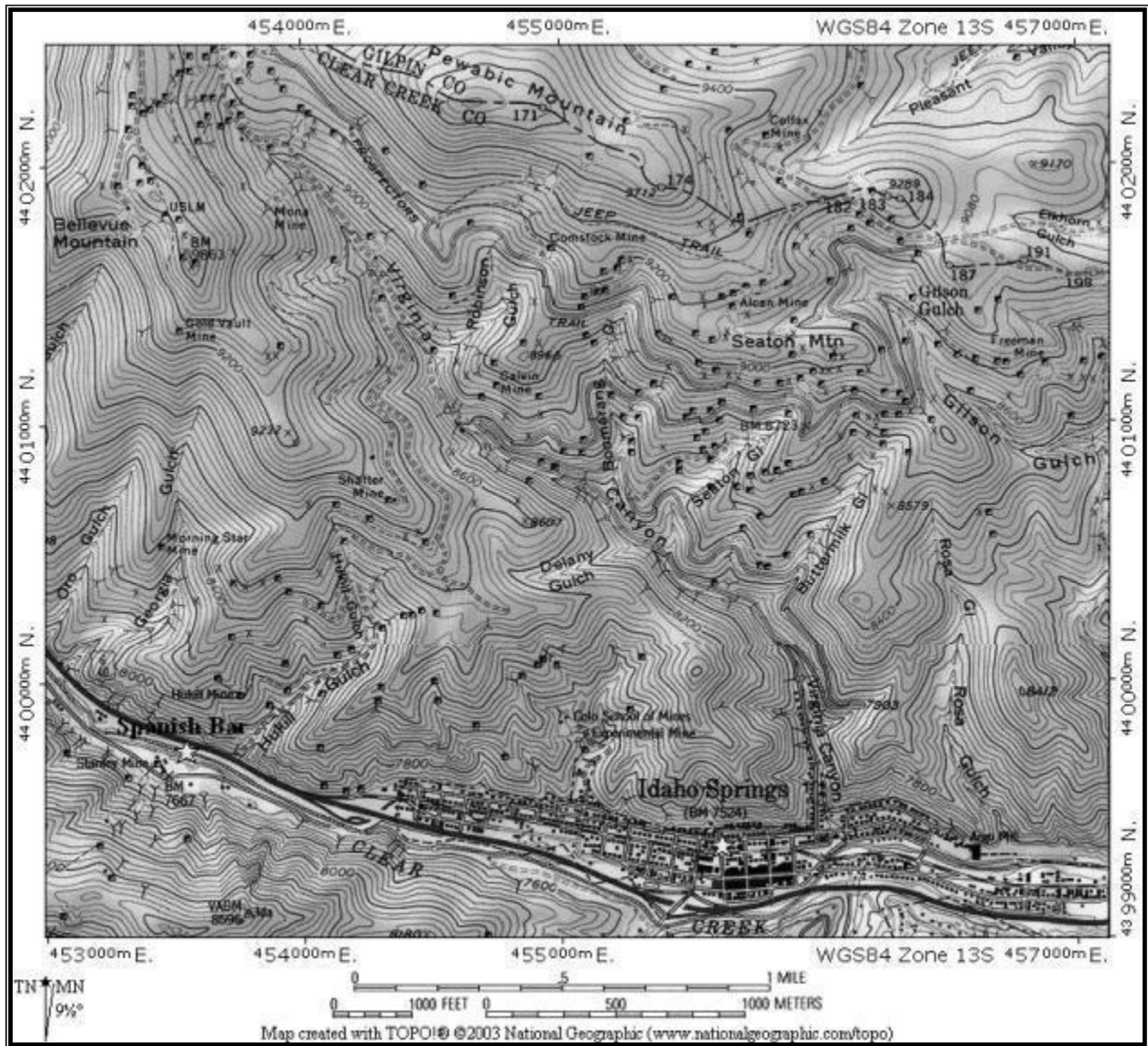


Illustration A 1.2.17: Seaton Mountain, Virginia Canyon, and Bellevue Mountain, north of Idaho Springs, were honeycombed with mines. Spanish Bar, to the west, hosted the Whale, Hukill, and other major gold producers. Many mines are not shown and most are unnamed. I-70 follows Clear Creek. Source: National Geographic TOPO! digital map (on CD).

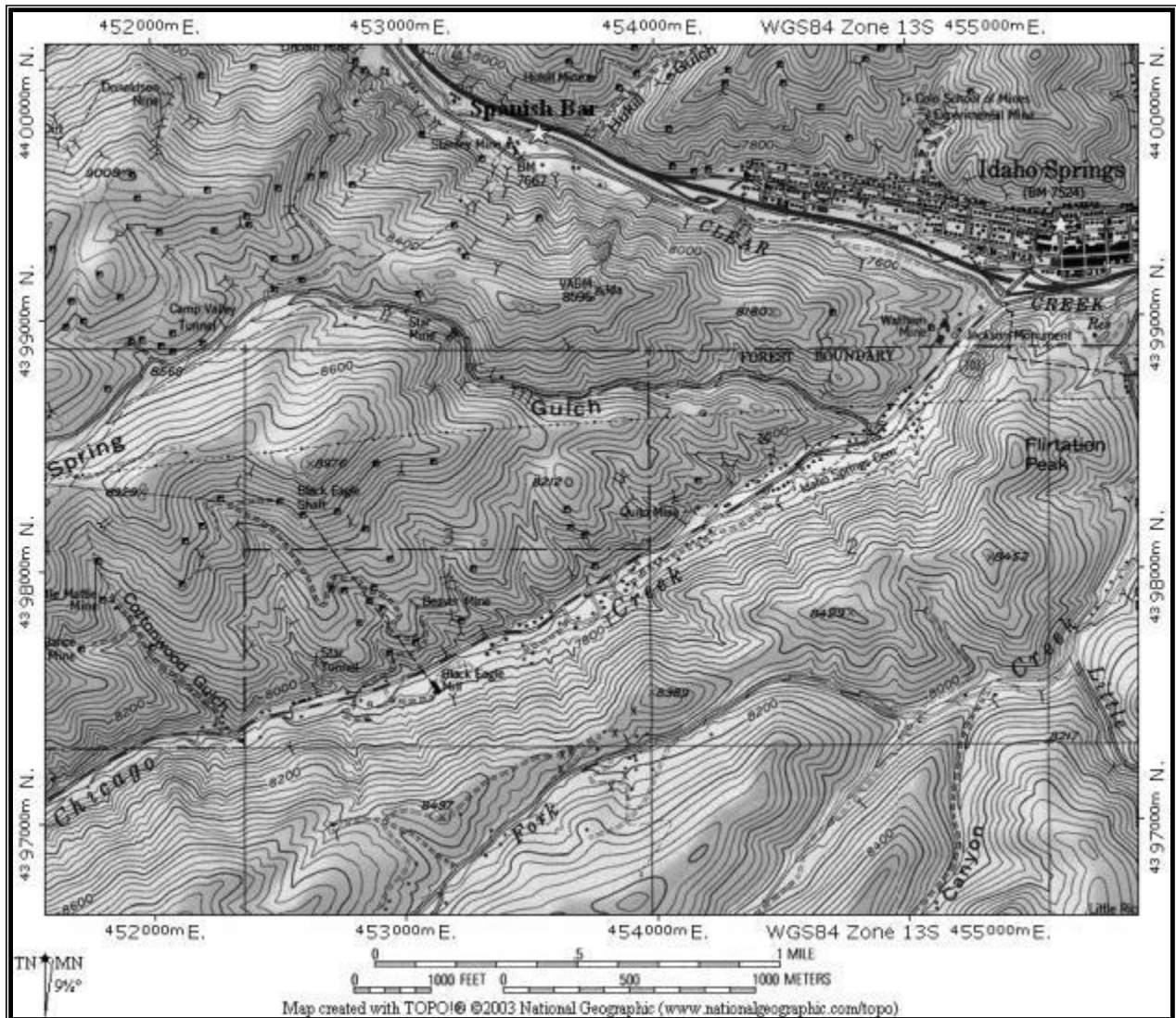


Illustration A 1.2.18: Chicago Creek and Spring Gulch, southwest of Idaho Springs, featured numerous gold producers, large and small. Source: National Geographic TOPO! digital map (on CD).

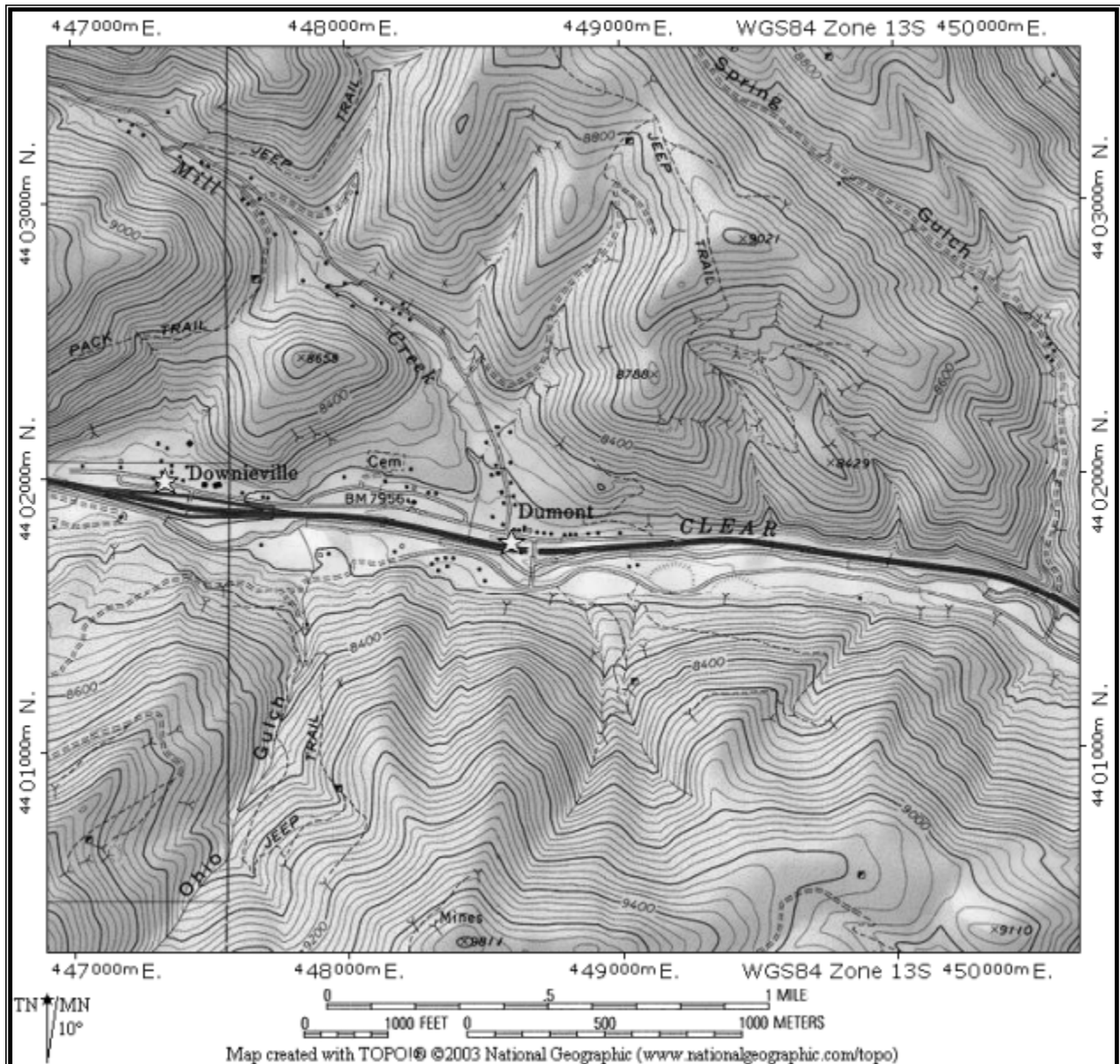


Illustration A 1.2.19: Dumont was center to mines on the valley’s north and south sides, none named on the map. The Albro was among the group of tunnels shown northeast of town. I-70 follows Clear Creek. Source: National Geographic TOPO! digital map (on CD).

The Silver Crash, 1894-1897

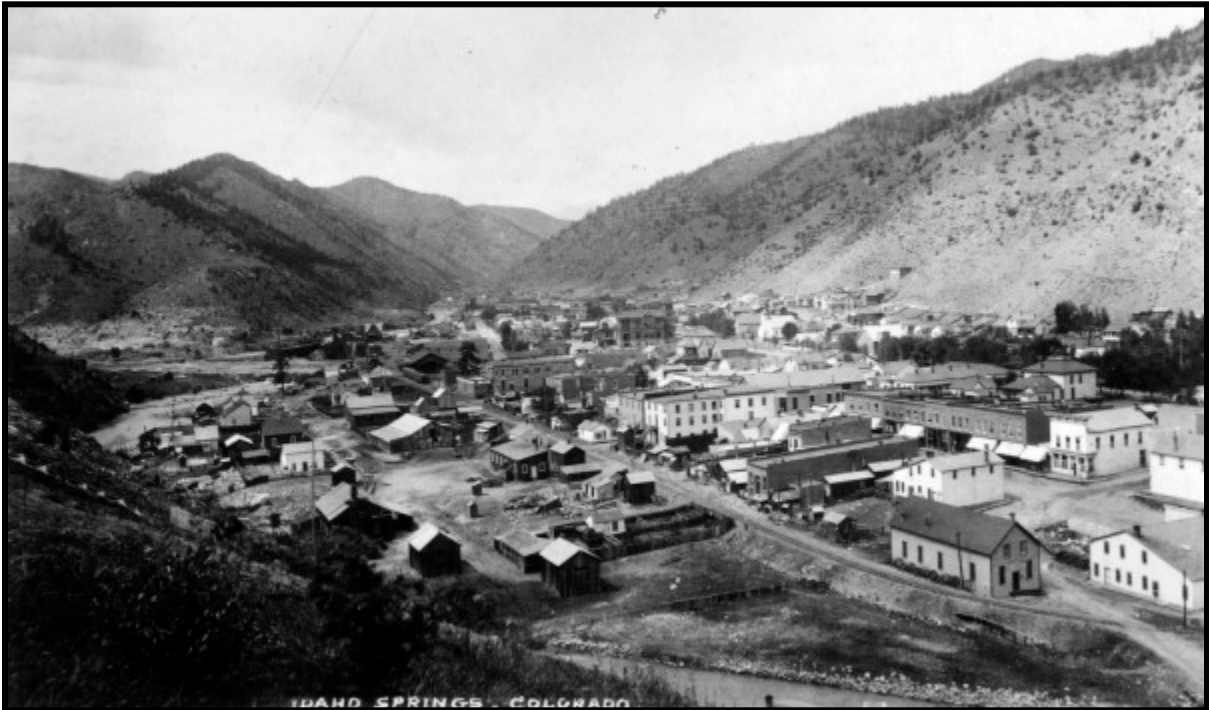


Illustration A 1.2.20: A boom in gold mining allowed Idaho Springs to grow into an urban center during the mid-1890s, when most of Colorado was in depression. Courtesy of Denver Public Library, X-2265.

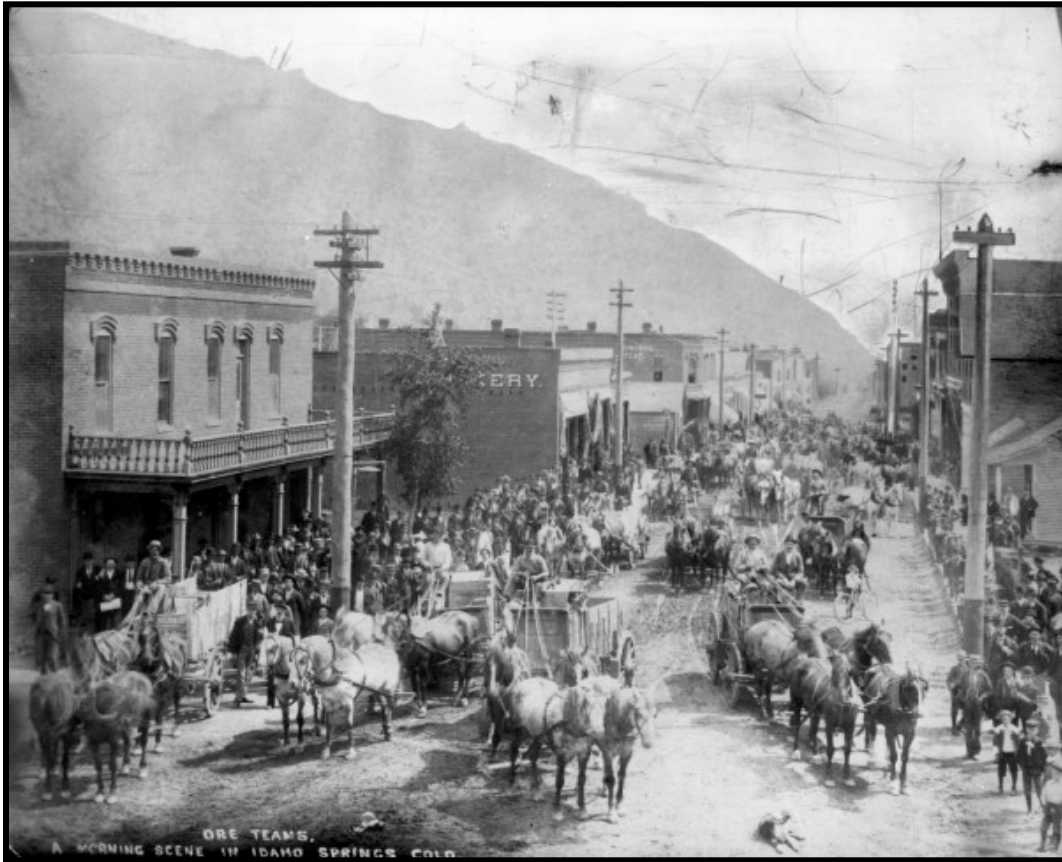
Peak Production in the Eastern Drainage, 1898-1918

Illustration A 1.2.21: Eastern Clear Creek drainage reached a peak in production between around 1897, when the photo was taken, and 1907. Ore flowed down into Idaho Springs from all directions in wagons, which clogged already busy streets. Idaho Springs featured a record number of ore treatment mills. Courtesy of Denver Public Library, X-2269.



Illustration A 1.2.22: The Stanley Mine was a result of the mid-1890s gold boom in eastern Clear Creek drainage. The operation, a consolidation of properties on both sides of the valley, became one of the most advanced mines in the region. The building at left is an icon visible from I-70 today. Harry H. Buckwalter photographed the southwest view around 1900. Courtesy of Denver Public Library, CHS-B1486.

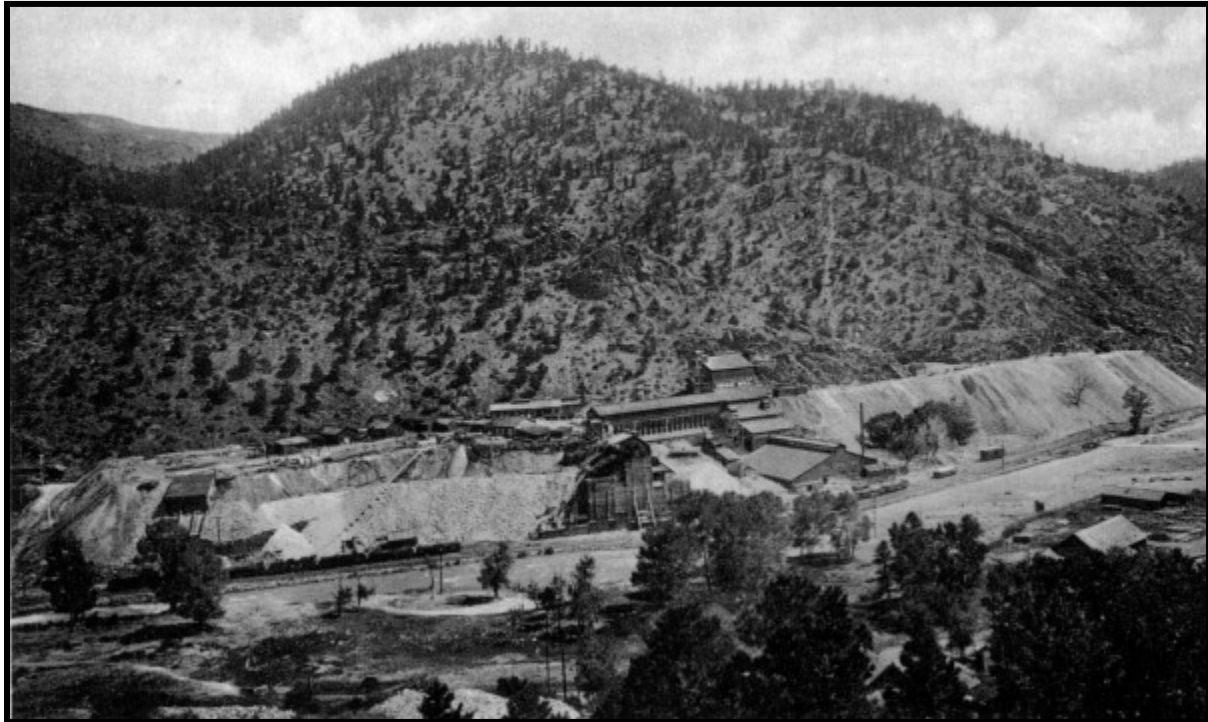


Illustration A 1.2.23: The Newhouse Tunnel, also known as the Argo, extended north from Idaho Springs to Central City. The tunnel was designed as a deep drain and haulageway for mining companies in the mountains in between. They paid royalties to work their properties from the inside out and shuttle ore to the Newton and Newton Annex mills at the tunnel portal. Through its function, success, and distance of approximately seven miles, the tunnel was an engineering marvel that set a precedent in the greater mining industry. The tunnel, left of center in this northeast view, undercuts mountains in the background. Courtesy of Denver Public Library, X-61683.



Illustration A 1.2.24: The Aorta Tunnel was among Empire's earliest profitable mines but went idle during the 1880s. During the late 1890s, the Empress Mining & Tunnel Company lengthened the tunnel as a deep haulage way for other mines. The operation became one of Empire's most important. The mill, a good example of an amalgamation stamp mill, may have been built by the Bay State Mining Company during the 1860s. Photo date is uncertain, although likely in the 1890s. Source: Spurr, 1908.

Gradual Decline in the Western Drainage, 1898-1907

Illustration A 1.2.25: By 1905, when the Centennial Mill was photographed at Georgetown, western Clear Creek the drainage had already experienced approximately forty years of continuous production. The rich silver ore was nearly exhausted, and mining companies built new, efficient mills in an attempt to render the remaining low-grade material profitable. Reflecting changing conditions and gradual decline of the industry, the Centennial plant was built over the ruins of an earlier mill. George Dagleish took this view during the 1890s. Courtesy of Denver Public Library, X-61590.

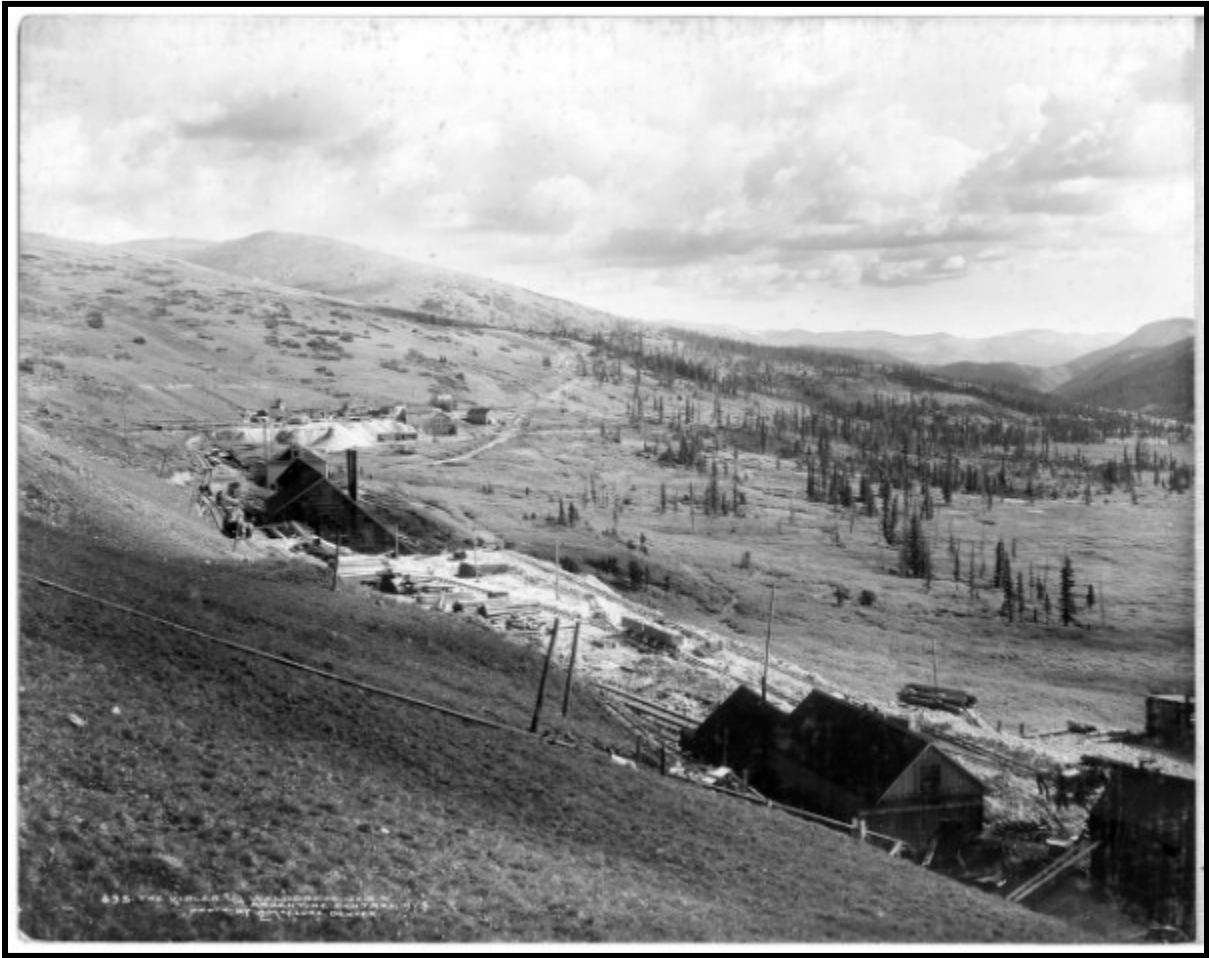


Illustration A 1.2.26: In the northeast overview, the Vidler Tunnel complex is in the foreground and Wilcox Tunnel and settlement of Waldorf is in the left background. Both were important operations in the Argentine Mining District from 1907 through 1910. Waldorf was center of Edward Wilcox's mining empire, including the Wilcox Tunnel and mill, Argentine Central Railroad terminus, and a tourist hotel. The abandoned townsite of Argentine was on the valley floor at far right, and Georgetown lay over the ridge beyond. Charles McClure took this north view around 1910. Courtesy of Denver Public Library, MCC-695.

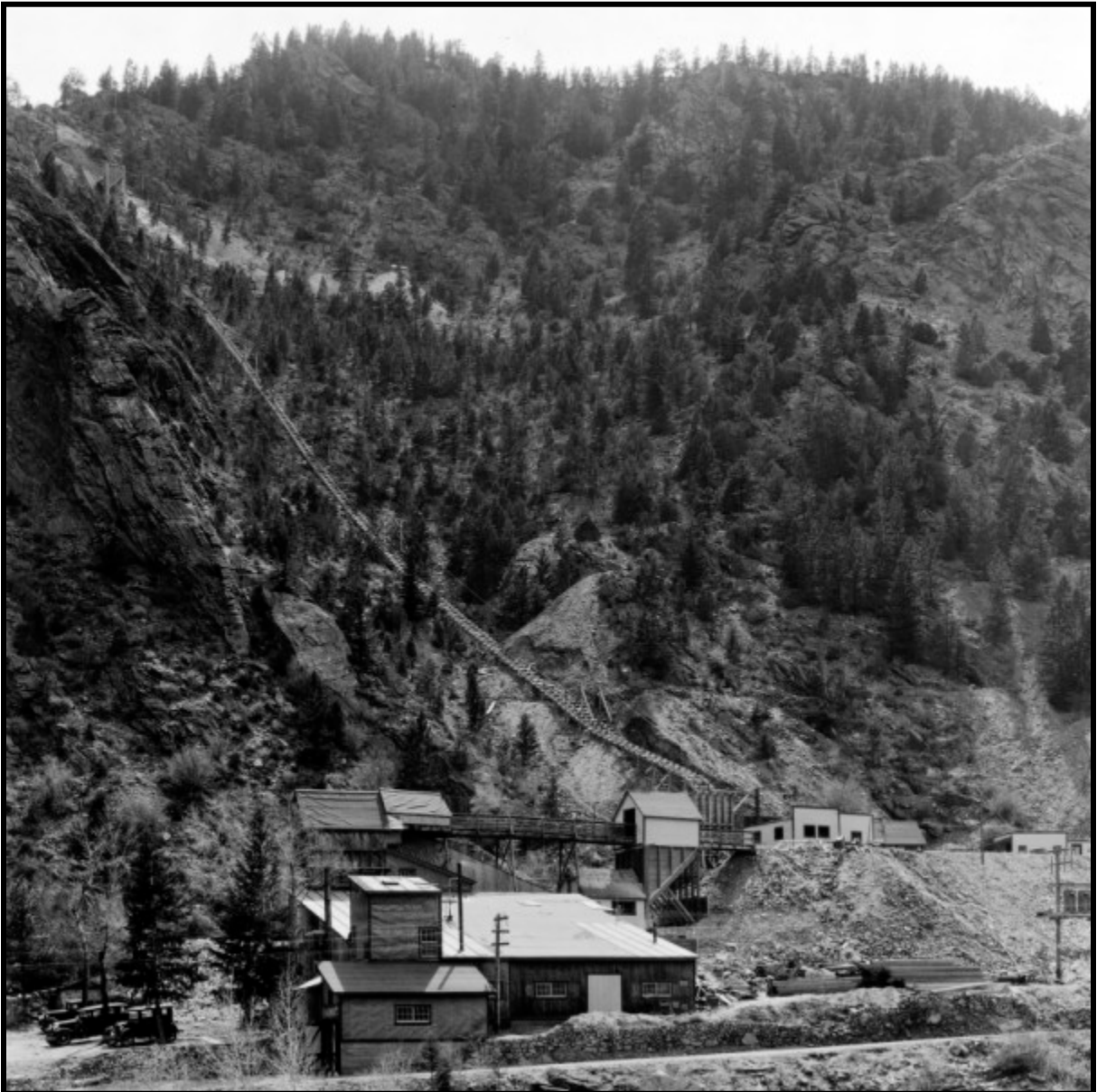
Great Depression Revival in the Eastern Drainage, 1930-1942

Illustration A 1.2.27: The Alma Lincoln Mine, visible today on the south side of I-70 west of Idaho Springs, was a cornerstone of the Great Depression-era revival in eastern Clear Creek drainage. The mine and others like it provided employment, economic contributions, and a sense of wellbeing for the region during an important time of need. Most of the buildings in the photo, including mill at center, still stand intact. Courtesy of Denver Public Library, X-61670.

Section A 1.3: History of Mining at Frisco and Dillon, Summit County

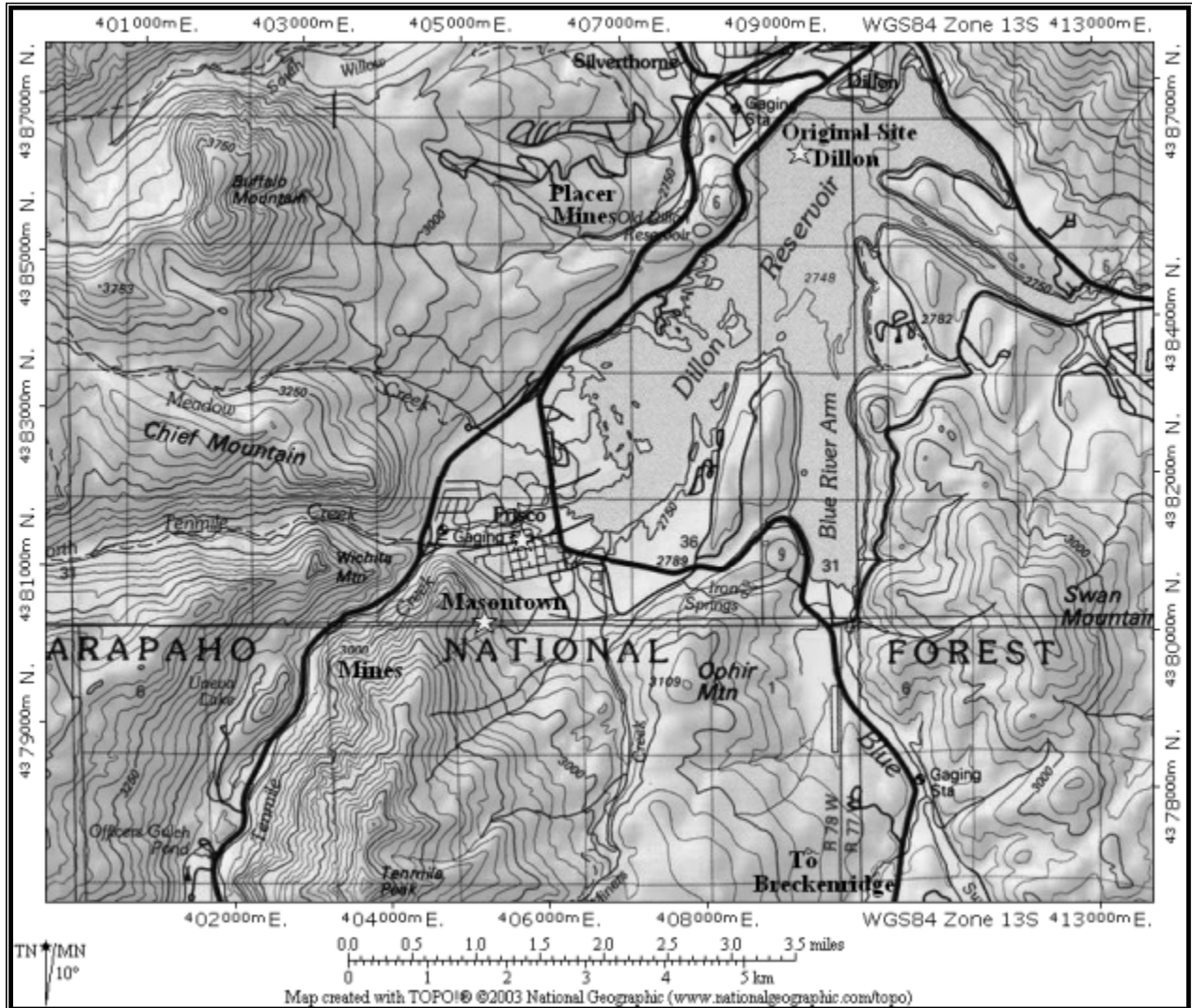


Illustration A 1.3.1: The map illustrates the principal geographic areas associated with mining around Dillon and Frisco. The original site of Dillon, upper right, is now underneath Dillon Reservoir, and large placer mines are west. Frisco is at the mouth of Ten Mile Canyon, extending southwest. Most hardrock mining developed in the canyon. Blue River ascends south from Dillon Reservoir to Breckenridge, off the map. The dark line extending from lower left to upper right is I-70. Source: National Geographic TOPO! digital map (on CD).

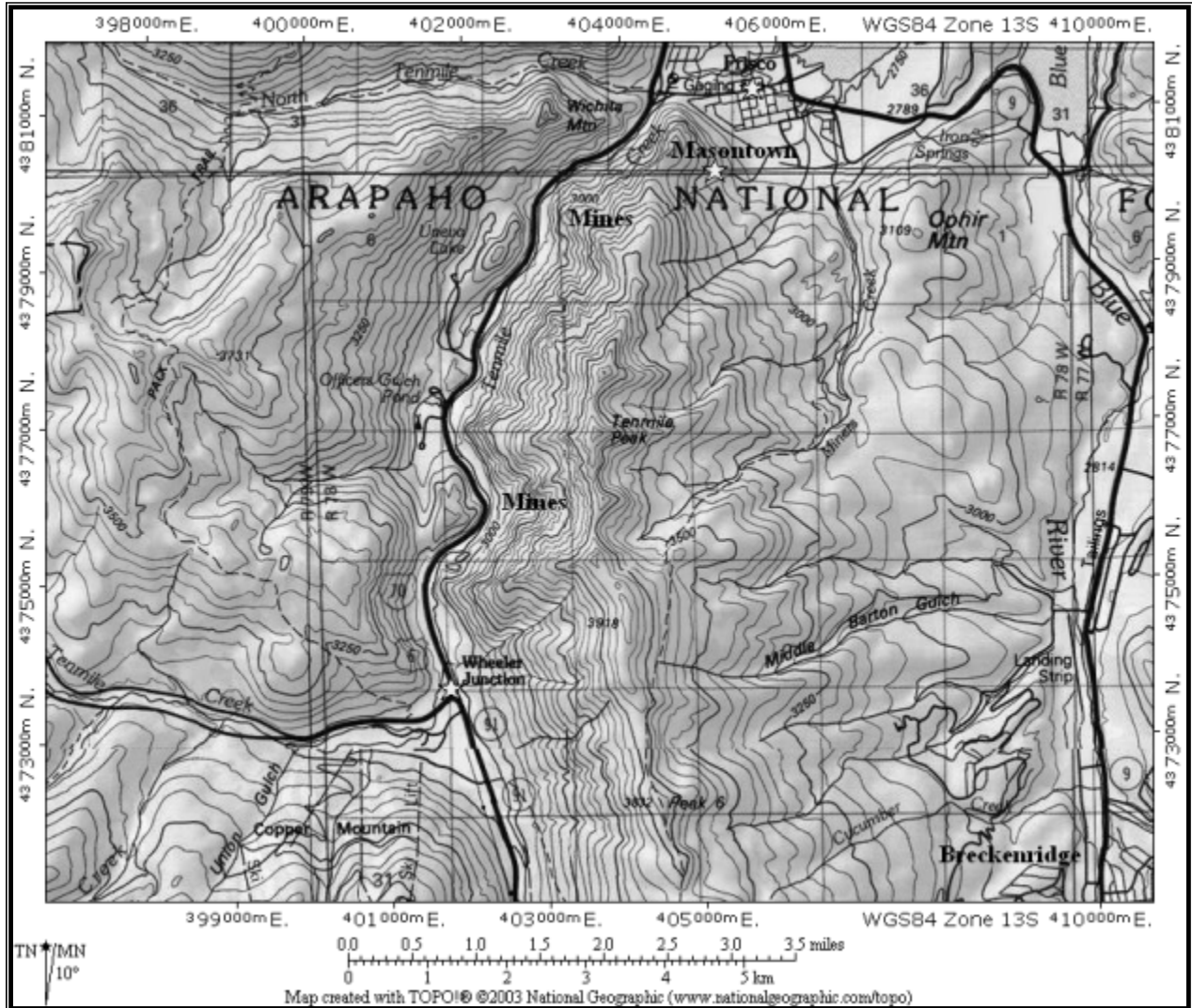


Illustration A 1.3.2: The map is a southwest continuation of the image above. Wheeler, a logging and mining hamlet, is at lower center, near present-day Copper Mountain ski area. The dark line following Ten Mile Canyon and veering west at Wheeler is I-70. Breckenridge is at lower right, and Ten Mile Range is between Breckenridge and Wheeler. Source: None of the properties are named individually, but are generally noted by Mines on the canyon's east side. National Geographic TOPO! digital map (on CD).

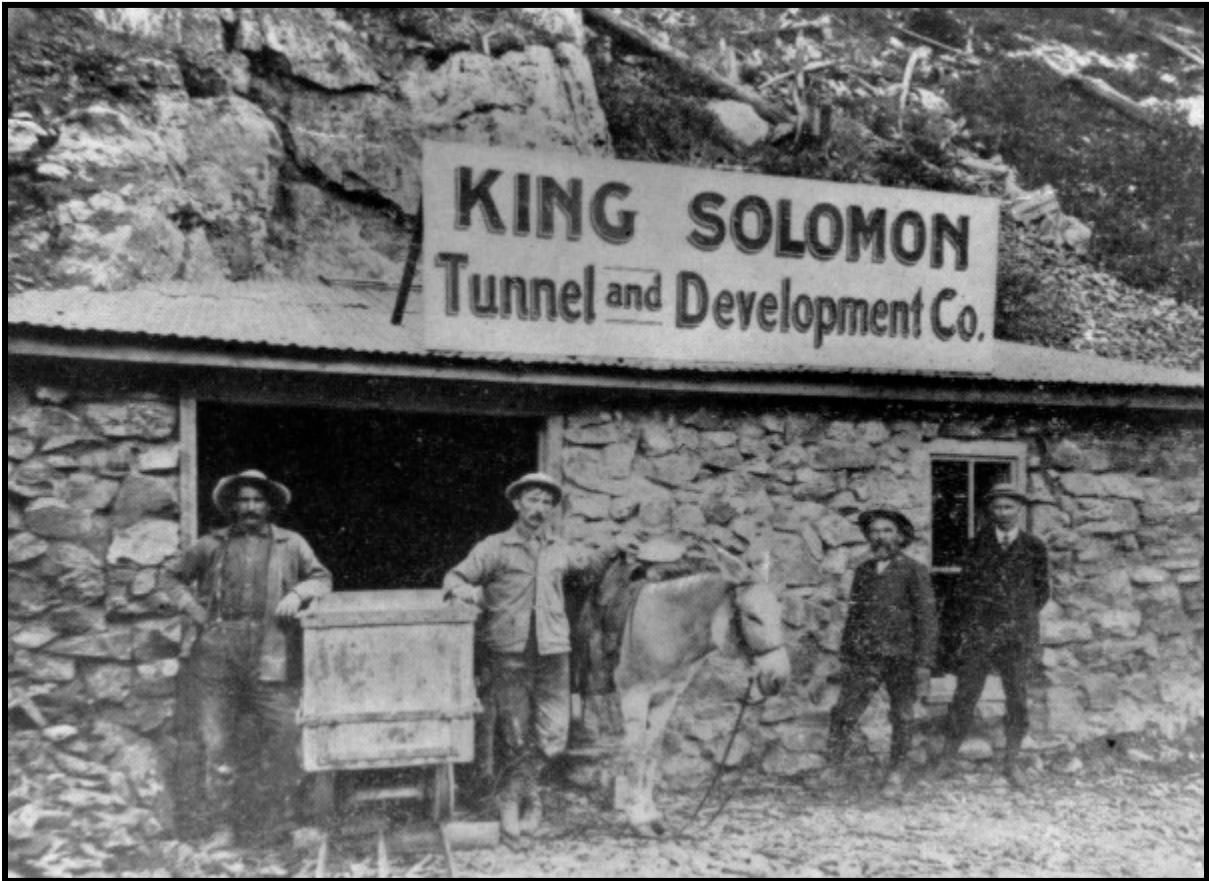
The Great Mining Revival, 1898-1912

Illustration A 1.3.3: James Myers' King Solomon Mine was among the principal operations in Ten Mile Canyon near Frisco during the revival at the turn-of-the-century. The mine remained relatively simple in its early years, as in this 1905 view, and was not immediately profitable, like most other properties in the area. Courtesy of Denver Public Library, X-62432.

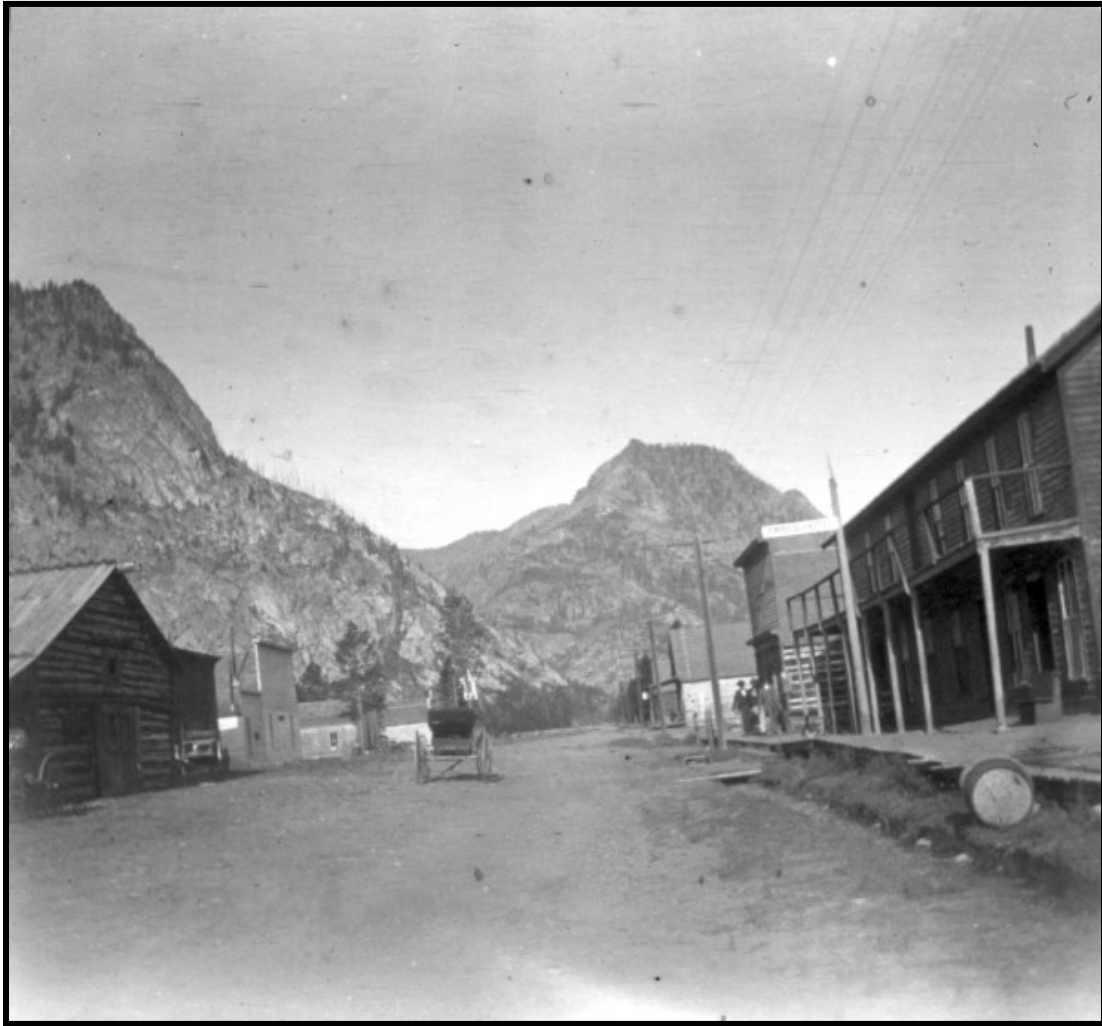


Illustration A 1.3.4: Despite the revival of mining after the turn-of-the-century, Frisco remained small and quiet with little new construction. The architecture in this main street photo is typical of Rocky Mountain mining towns, including log buildings, false-fronts, brick business building, and boardwalks. Courtesy of Denver Public Library, X-8562.

Section A 1.4: Mining and Milling Methods, Technology, and Equipment**Placer Mining**

Illustration A 1.4.1: Placer miners near Breckenridge process gravel in a cradle during the 1880s. They shoveled gravel into the hopper at top, flushing it down the riffles with water while rocking the apparatus. The motion caused heavy gold to settle along riffles while light gravel washed through and into the tub. Courtesy of Denver Public Library, X-61131.

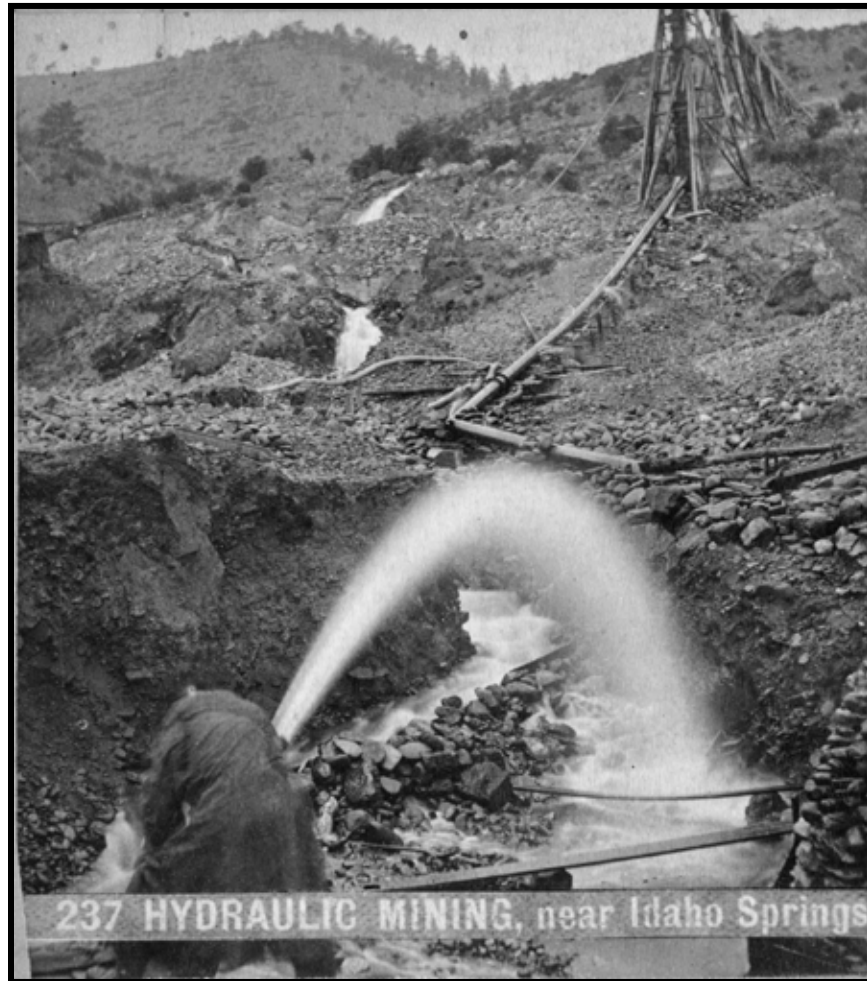


Illustration A 1.4.2: A miner blasts and loosens gold-bearing gravel with a hydraulic monitor near Idaho Springs. The pipeline and trestle on the slope pressurized water for the monitor, and the cascade washed the mobilized gravel down through sluices. Note the high cut-banks. Source: Christine Bradley, Clear Creek County Historian.

Hardrock Mining

Illustration A 1.4.3:

The illustrated shop is representative of those at prospects and small mines. Such shops usually consisted of little more than a forge, an anvil, and hand-tools, which restricted work to drill-steel sharpening and the manufacture of light hardware.

Source: Drew, 1910:1.

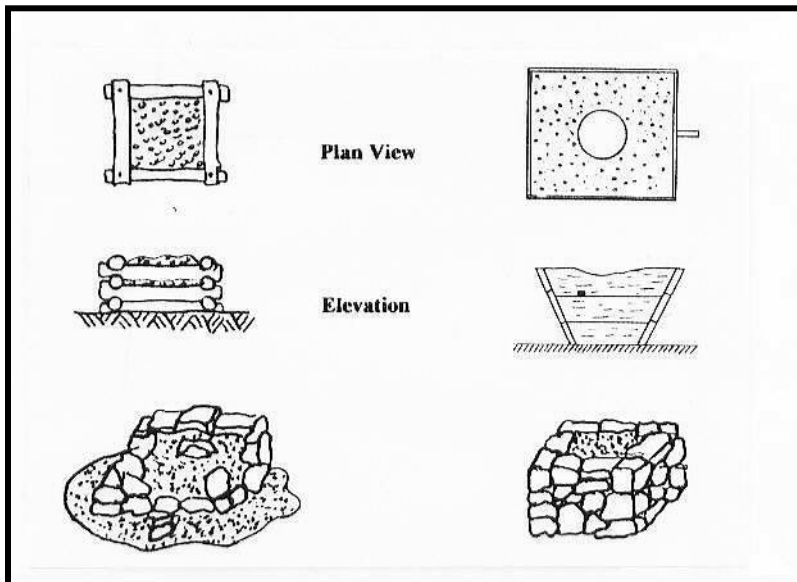
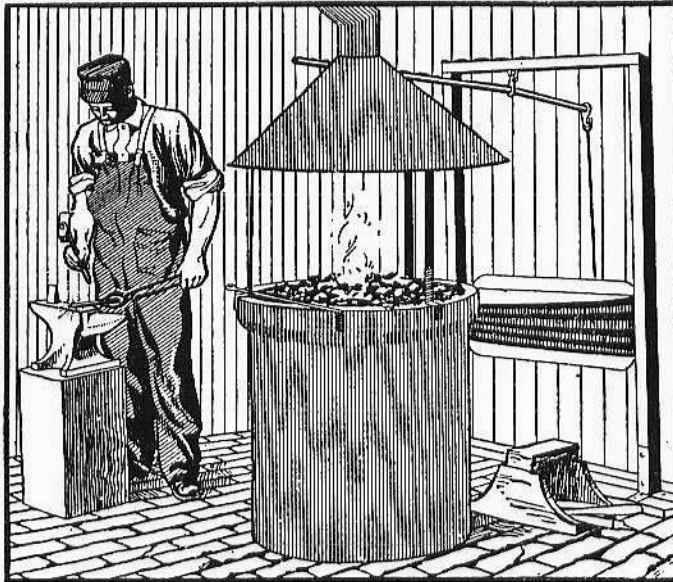


Illustration A 1.4.4:

Examples of the common forges used in blacksmith shops.

At upper left is a gravel-filled log forge, at right is a wood box forge, and at lower right is a dry-laid rock forge. Over time, rock forges decay and collapse, and manifest as the remnant at lower left. Source: Eric Twitty, 2002.

Illustration A 1.4.5: At right is a common ventilation blower used to force fresh air underground. Ducting was fastened to the nozzle, and a belt turned the machine. Source: International Text Book Company, 1899, A41:146.

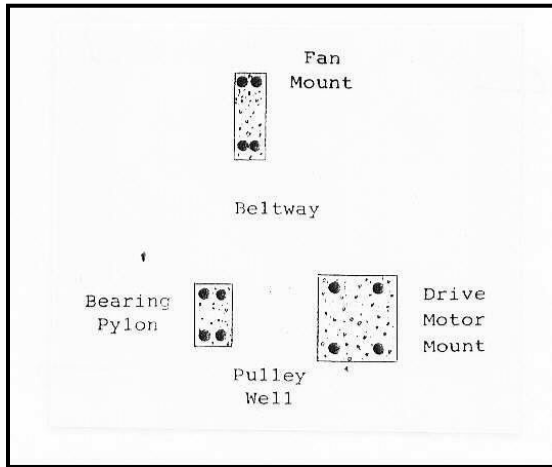
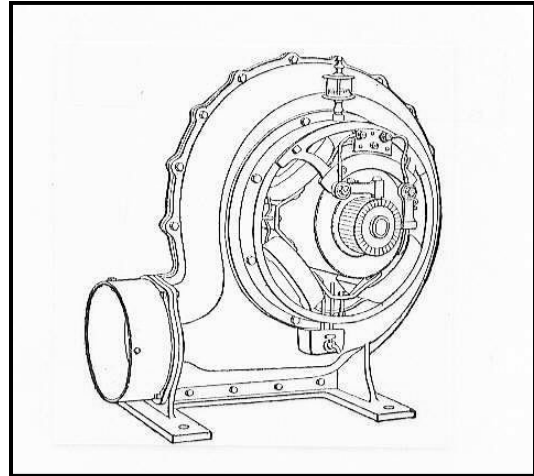


Illustration A 1.4.6: The plan view at left depicts a typical concrete foundation for a ventilation blower and its drive motor. Source: Eric Twitty, 1999.

Illustration A 1.4.7: When intact, shafts often are divided into several compartments for hoisting and egress. The collars are usually timbered to retain loose material, and are flush with the surrounding ground. Intact examples are rare and important engineering resources. Source: Eric Twitty, 2006.

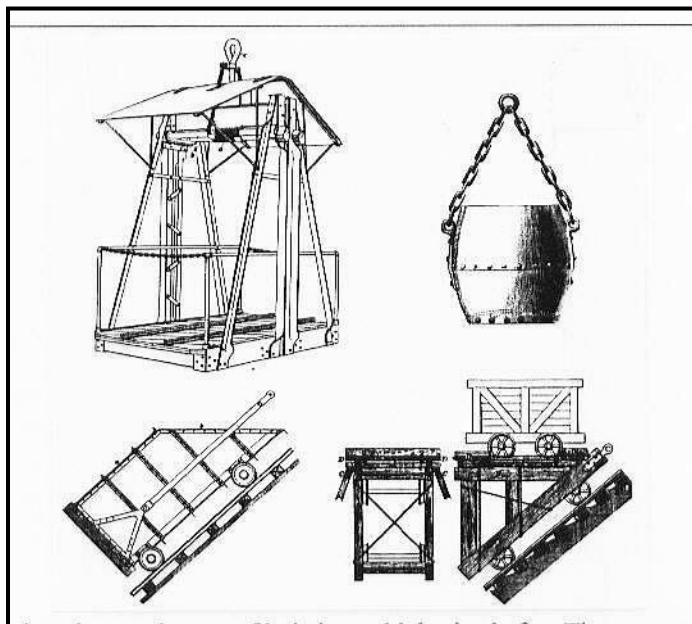


Illustration A 1.4.8: Mining companies employed several types of hoisting vehicles in shafts. The cage at upper left, popular from the 1870s through the 1930s, ran on guide rails and carried miners or an ore car. The sinking bucket at upper right required no rails and was common among small operations. The skip at lower left was popular in both vertical and inclined shafts by 1900. It ran on rails and required guides in the headframe to empty. At lower right is a vehicle for inclined shafts that became obsolete by 1900. Source: Twitty: 2002:151.

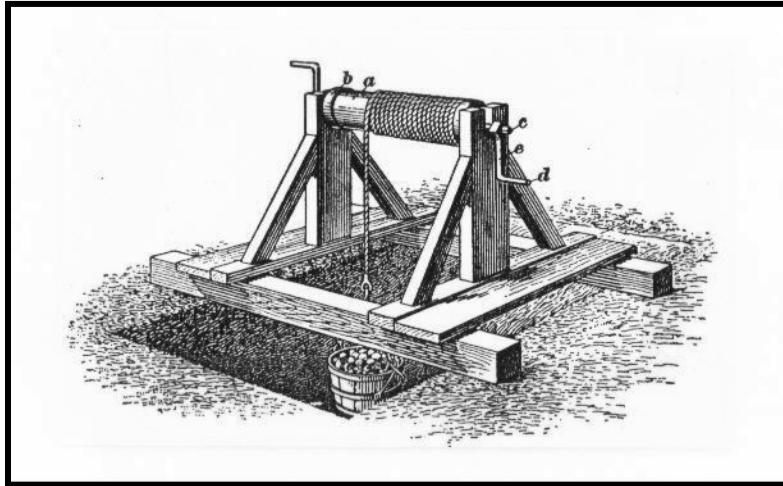


Illustration A 1.4.9: The windlass was an institution among prospectors, and nearly all shafts less than 100' deep were equipped with this simple, inexpensive, and portable type of hoist. Source: Twitty, 2002:145.

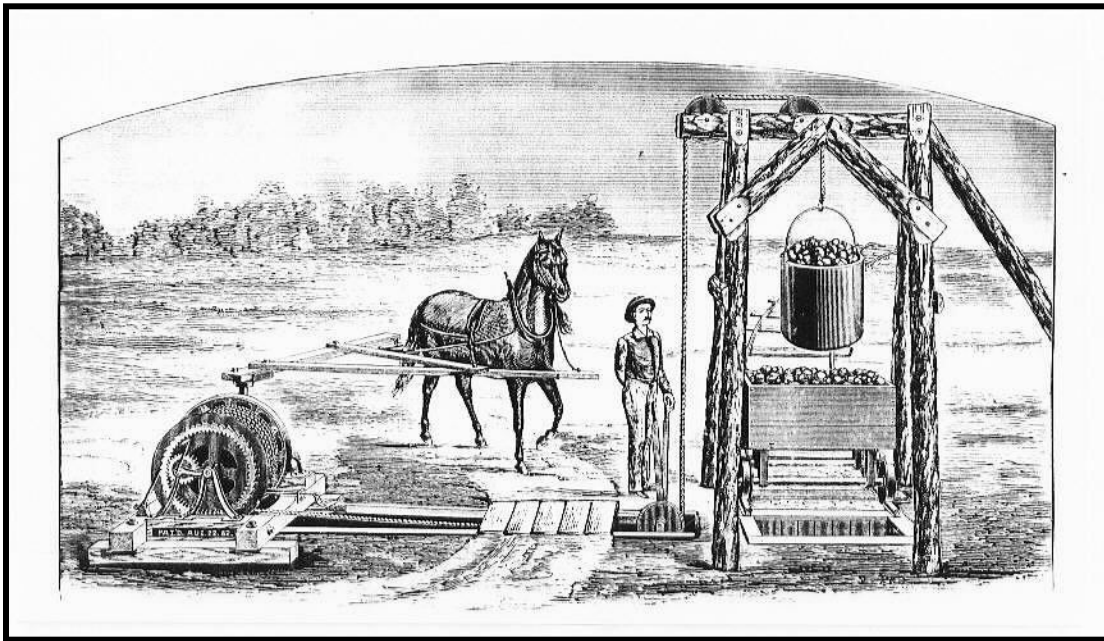


Illustration A 1.4.10: Horse whims were the most primitive type of mechanical hoist, and were a favorite among prospectors because of their simplicity and portability. The unit shown is a geared whim, which was popular from the 1880s through the 1910s. The hoist operator controlled a brake and clutch via levers mounted to the shaft collar. The control linkages and hoist cable passed through the trench. Source: Ingersoll Rock Drill Company, 1887:60.

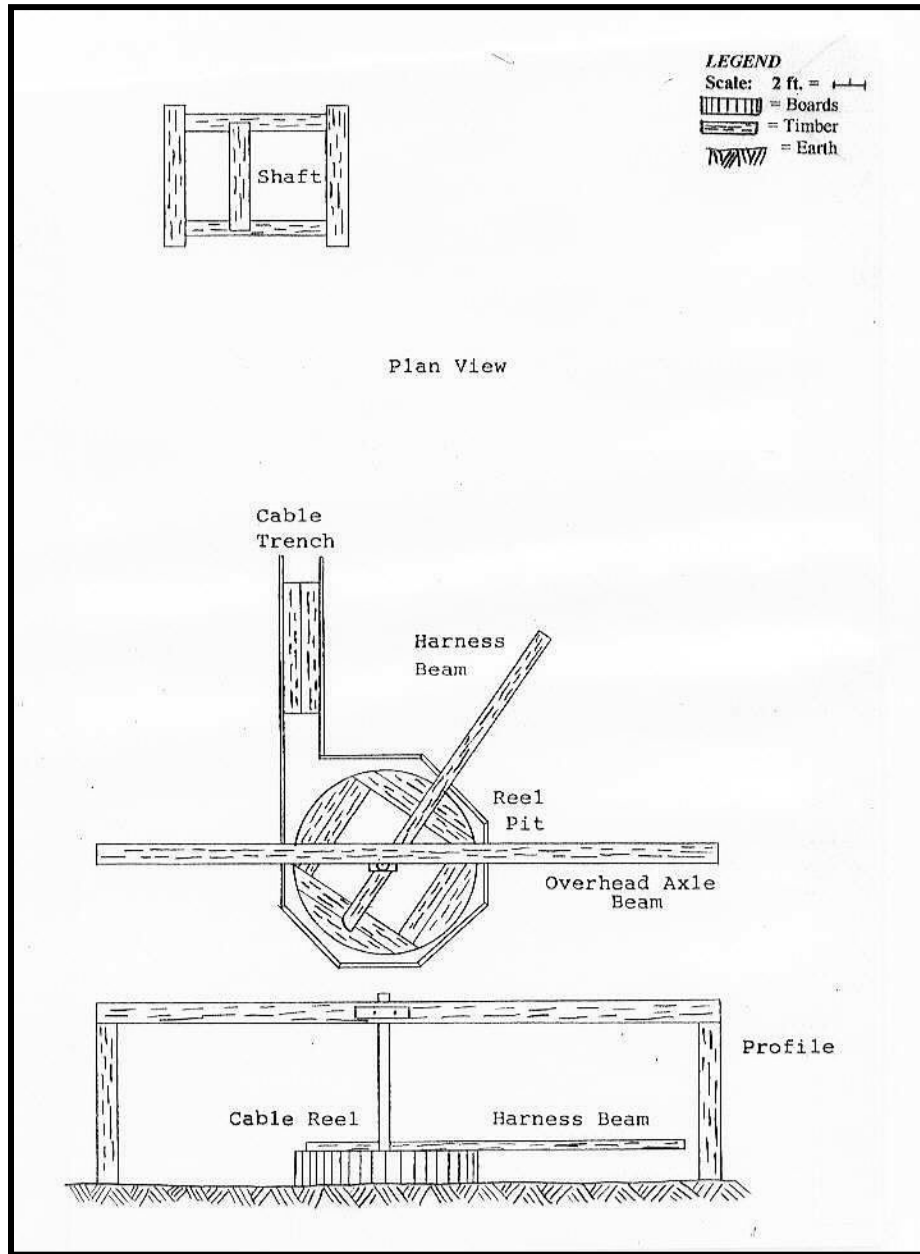


Illustration A 1.4.11: The plan view, top and middle, and elevation, bottom, depict a horizontal reel horse whim, which was a universal prospecting hoist prior to the 1880s. The reel was mounted to an axle on a timber footer buried in the floor of a plank-lined pit. Usually, only the pit and cable trench remain at prospect shaft sites today. Source: Eric Twitty, 1999.

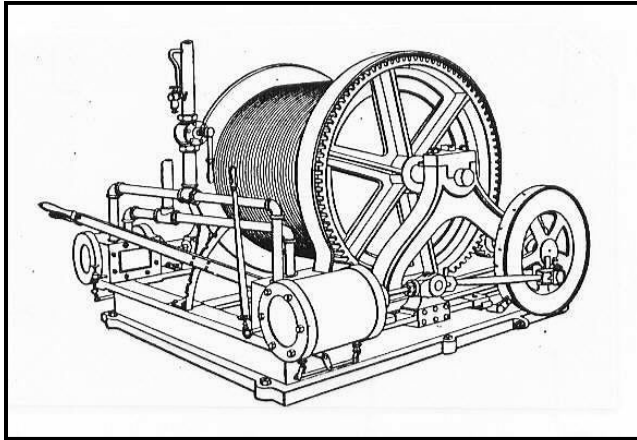


Illustration A 1.4.12: Single-drum geared steam hoists were the most common power type between the 1870s and 1910s. Gasoline and electric models became popular afterward. Source: International Text Book Company, 1906, A50:8.

IMPROVED HOISTING ENGINE.

Prize Medal, Mechanics' Fair, 1880

W. H. OHMEN,
Engine
AND
MACHINE WORKS,
No. 109 & 111 Beale St., S. F.

Upright and Horizontal
ENGINES & BOILERS.

SPECIALTIES:
Upright Engines from 4 to 15-horse power.
Also, Portable and Stationary Engines.

Illustration A 1.4.13
Donkey hoists were popular for deep prospecting after the 1880s because they were self-contained and required little site preparation other than a flat area. Source: *Mining & Scientific Press* (1881).

Illustration A 1.4.14: This type of gasoline hoist was employed for deep prospecting and minor ore production between around 1900 and 1930. A single-cylinder engine is at left, dual flywheels are at center, and the cable drum is at right. Source: International Textbook Company, 1906, A50:31.

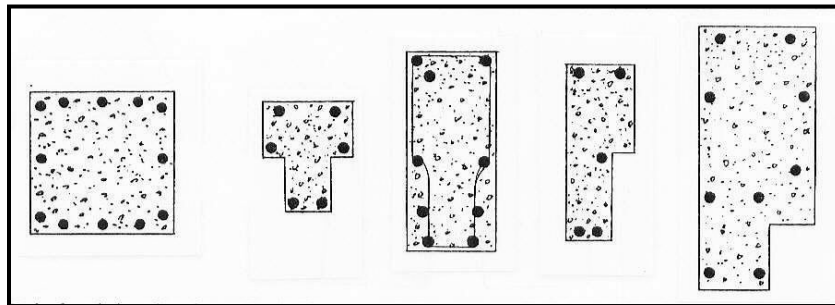
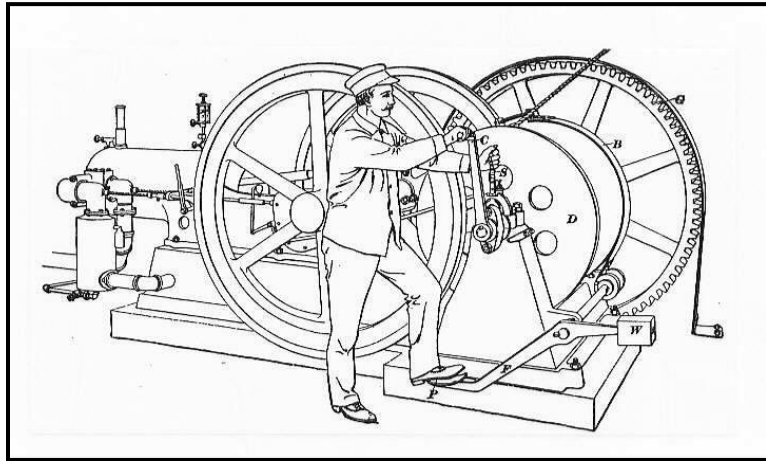


Illustration A 1.4.15: Hoist foundation plan views. Single-drum steam and electric hoists were bolted to foundations like the one at left, and the other foundations were for various types of gasoline hoists. Source: Twitty, 2002:187, 241.

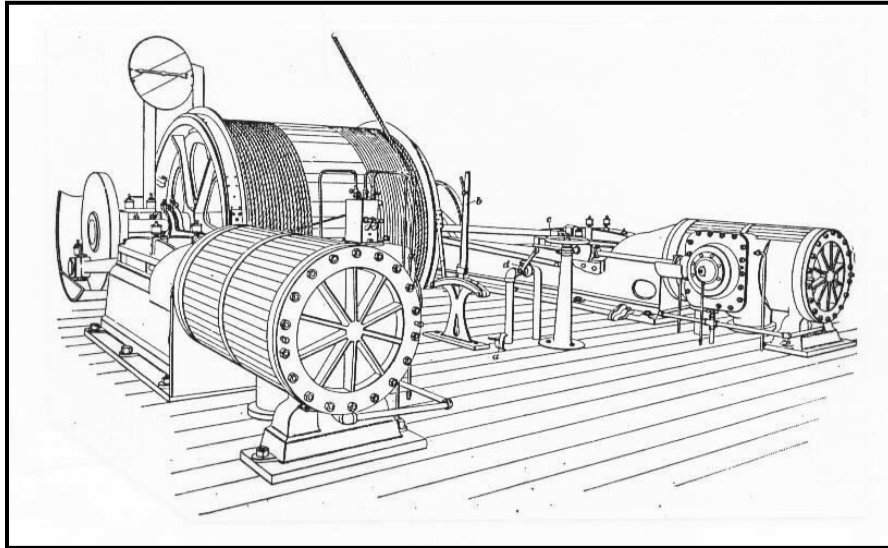


Illustration A 1.4.16: Rear quarter view of a direct-drive single-drum steam hoist. Powerful steam cylinders flank the hoist's controls, and the drive-rods are directly coupled to the cable drum. Source: International Text Book Company, 1906, A50:16.

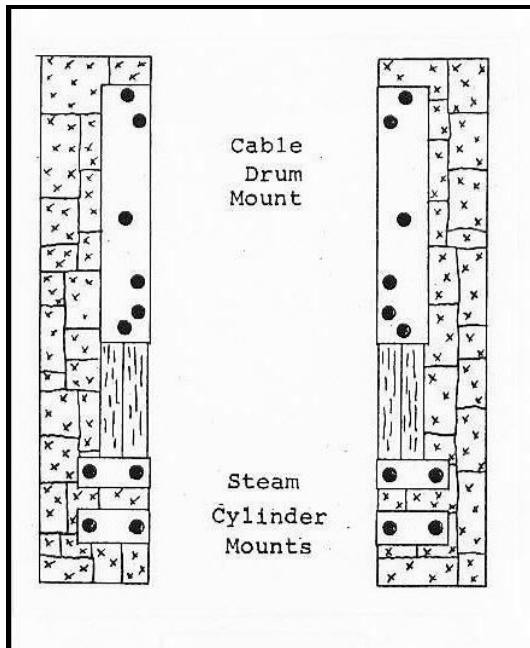


Illustration A 1.4.17: The plan view depicts a typical foundation for a direct-drive single-drum steam hoist. Such foundations are usually less than 14'x17' in area. Source: Eric Twitty, 1999.

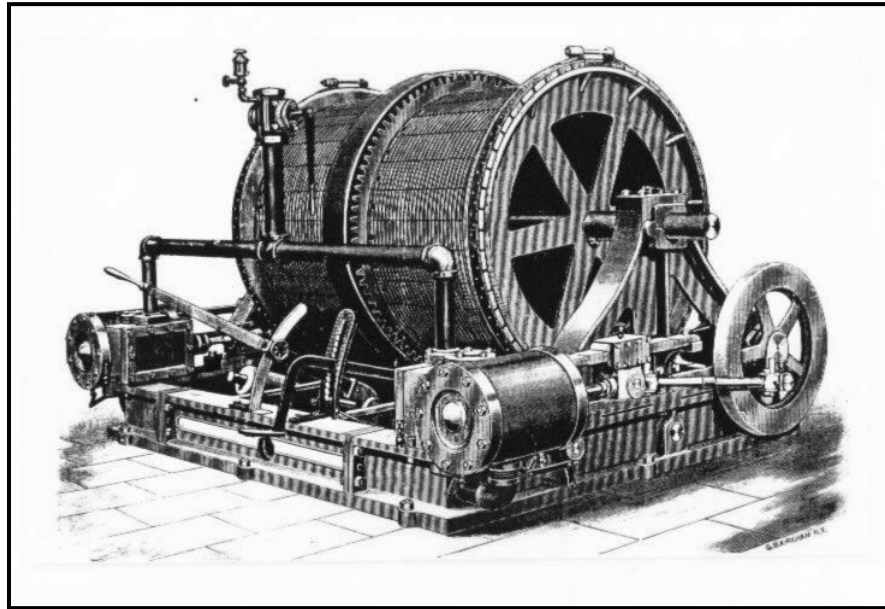


Illustration A 1.4.18: Rear quarterview of a geared double-drum steam hoist. Double-drum hoists, hallmarks of significant ore production, achieved balanced hoisting with two vehicles. Source: Ingersoll Rock Drill Company, 1887:65.

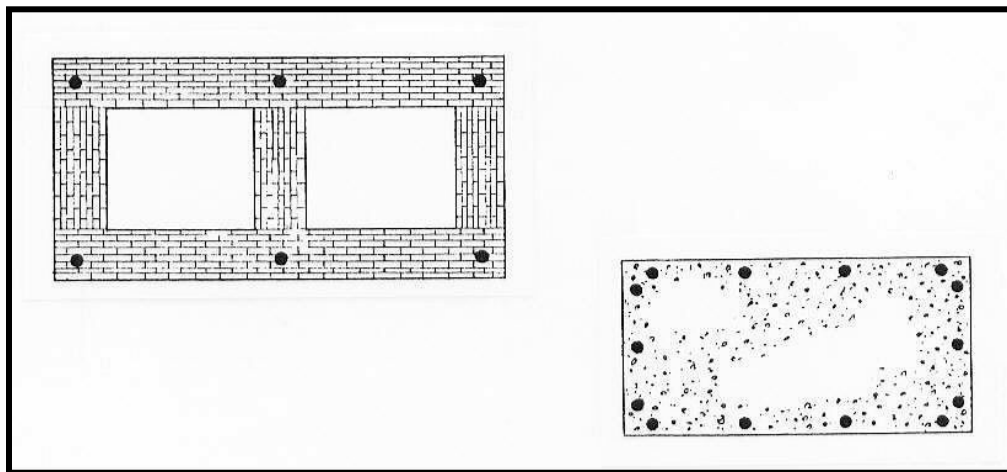


Illustration A 1.4.19: The plan views depict foundations for geared double-drum steam hoists. The foundation at left features wells for the hoist's cable drums. Source: Eric Twitty, 1999.



Illustration A 1.4.20: The rear quarterview illustrates a first-motion, double-drum hoist at the Gehrman Shaft, Stanley Mine, west of Idaho Springs around 1900. The hoist operator relied on the circular level gauge above the large machine to determine where in the shaft the cage vehicles were, exactly. The hoist room is immaculate, maps line the walls, and potted plants are by the window at right. Courtesy of Denver Public Library, CHS-B337.

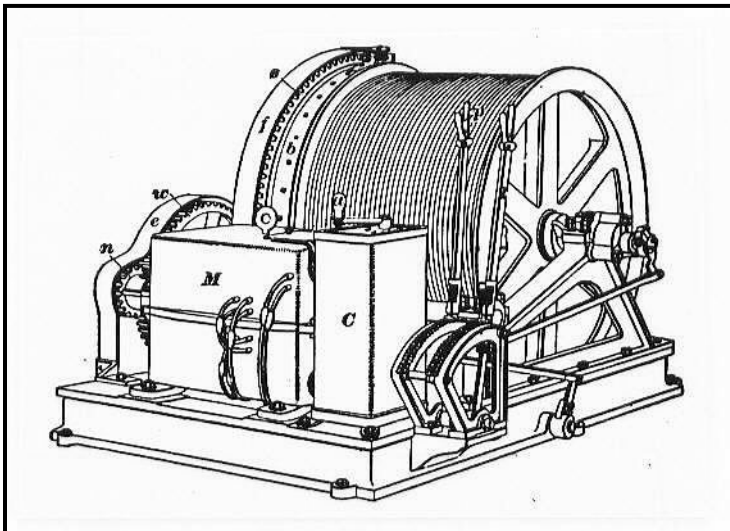


Illustration A 1.4.21: The single-drum electric hoist grew in popularity after 1900 where power was available. The motor is in the case in front, drive gearing is at left, and a speed controller in the upright box at center. Source: Twitty, 2002:224.

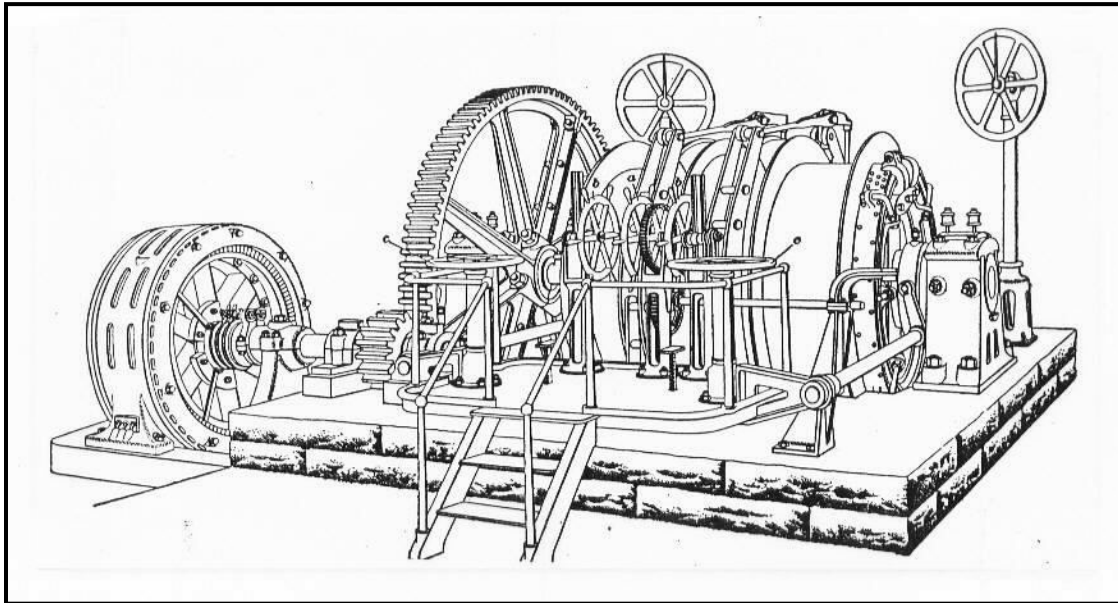


Illustration A 1.4.22: Rear quarterview of a double-drum electric hoist. The motor at left drove the dual cable drums via the large bull gear. Such hoists facilitated heavy production, saw use after the 1910s, and were popular among well-capitalized companies by the 1930s. Note the foundation. Source: International Textbook Company, 1906, A50:40.

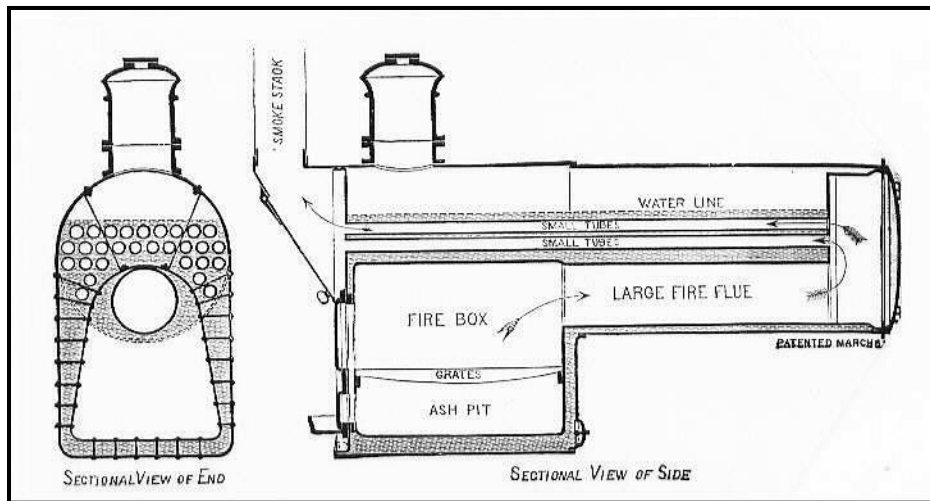


Illustration A 1.4.23: The Pennsylvania boiler was portable, stood on skids, and provided greater fuel economy than the locomotive type. Note the path traveled by the flue gases, which prolonged contact with the boiler surfaces. Source: Rand Drill Company, 1886:46.

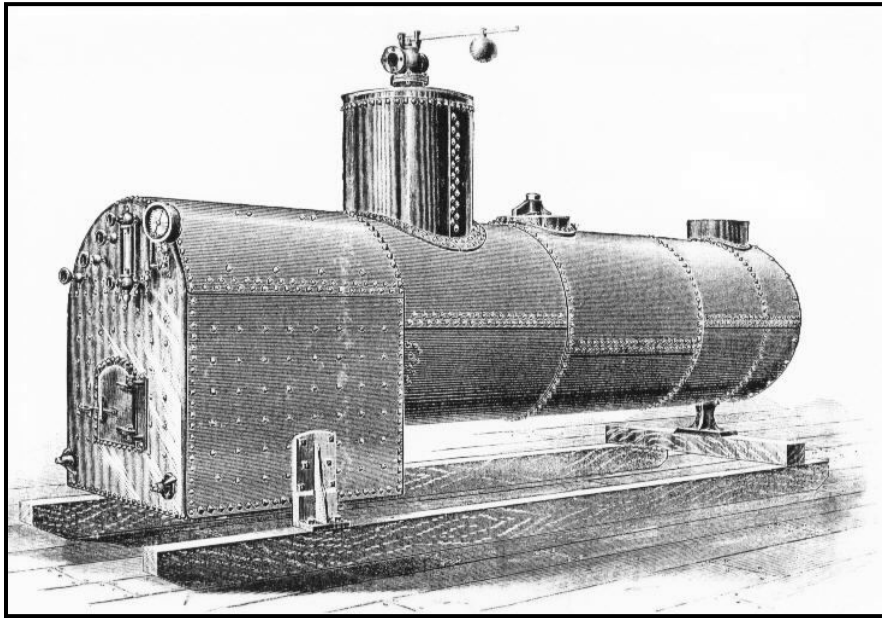
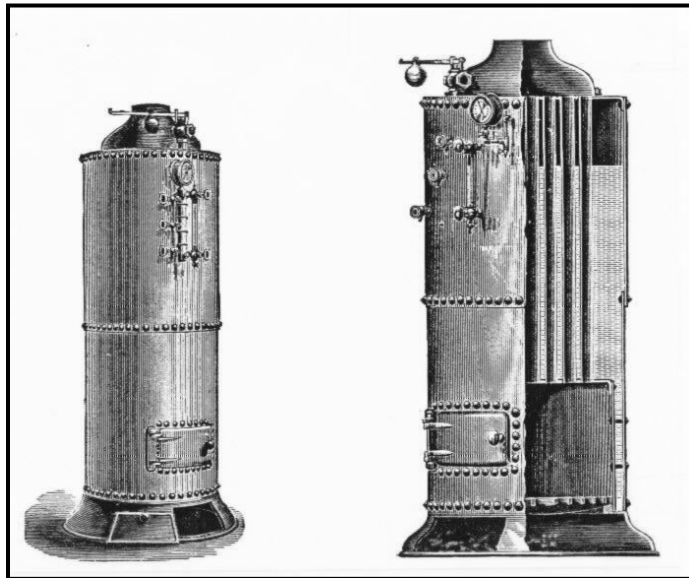


Illustration A 1.4.24: The locomotive boiler was one of the most popular steam generators for prospects and small mines. Flue gases traveled from the firebox at left through flue tubes in the tank and out a smokestack at right. Source: Rand Drill Company, 1886:45.

Illustration A 1.4.25: Upright boilers were the least expensive and most portable type of boiler, but also inefficient. Flue gases rose from the firebox at bottom, through the flue tubes, and out a smokestack at top. Note the water level sight tube, pressure gauge, and pressure valve. Source: Rand Drill Company, 1886:47.



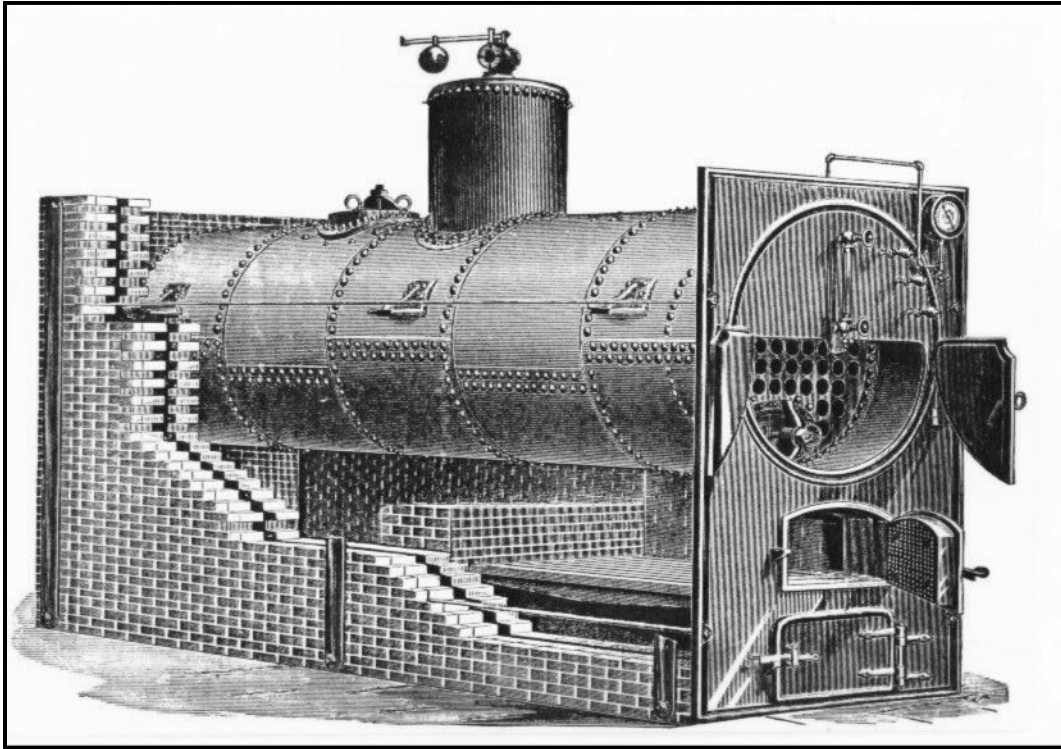


Illustration A 1.4.26: The return-tube boiler was the most popular industrial steam generator prior to the widespread embrace of electricity. The unit consisted of an iron shell, a masonry setting, and a cast iron façade. Flue gases traveled from the firebox behind the façade and under the shell. The gases rose into a smoke chamber at rear, reversed direction and returned through the flue tubes perforating the shell, and escaped out a smokestack over the façade. The top doors permitted workers to swab out the flue tubes. Source: Rand Drill Company, 1886:44.

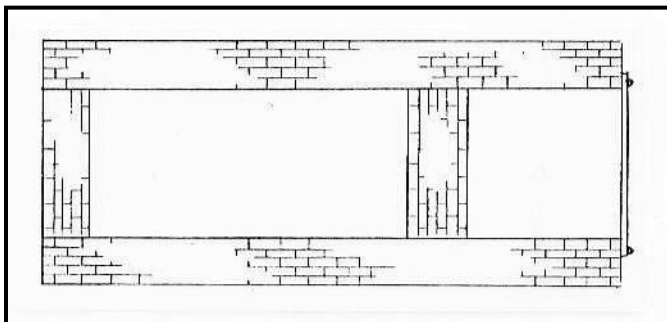


Illustration A 1.4.27: Few return-tube boilers currently remain intact and have been reduced to setting remnants and foundations, such as the one in the plan view. Source: Twitty, 2002:115

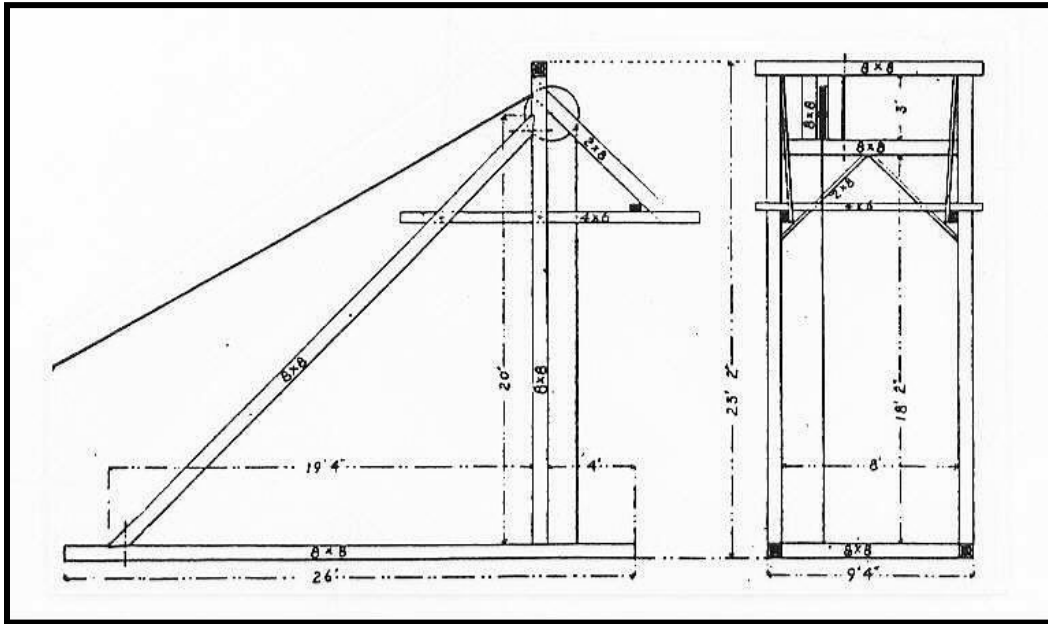


Illustration A 1.4.28: The two-post gallows headframe was the most common type for prospect shafts. Sinking-class versions were less than 25' high and stood on timber footers. Source: *Engineering & Mining Journal* (3/7/03) p366.

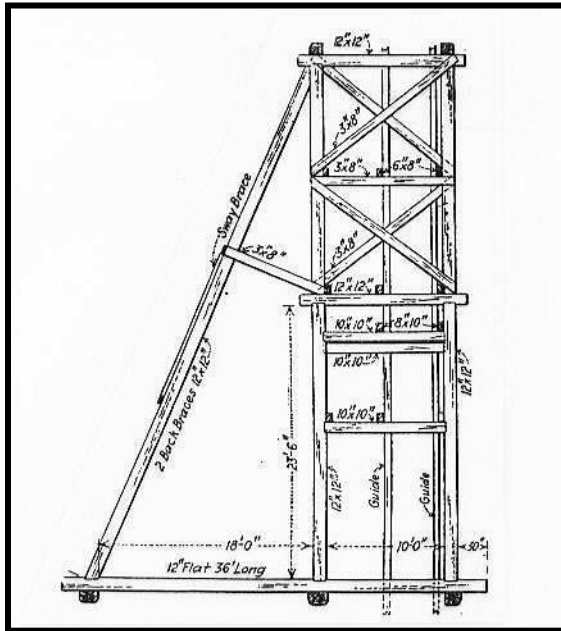


Illustration A 1.4.29: The headframe at left is a four-post derrick type. Production-class headframes such as the one illustrated tend to be higher than 25'. Source: *Engineering & Mining Journal* (12/28/17) p1216.

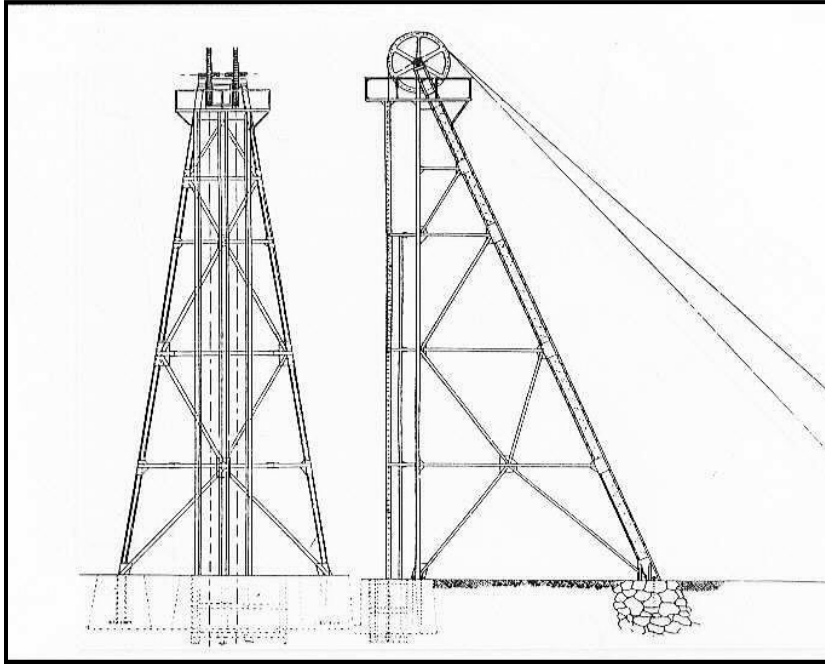


Illustration A 1.4.30:
 The illustrated headframe is a production-class two-post gallows structure known as a Montana type. These headframes were usually tall, well-built, and stood over deep shafts. Source: Twitty, 2002:233.

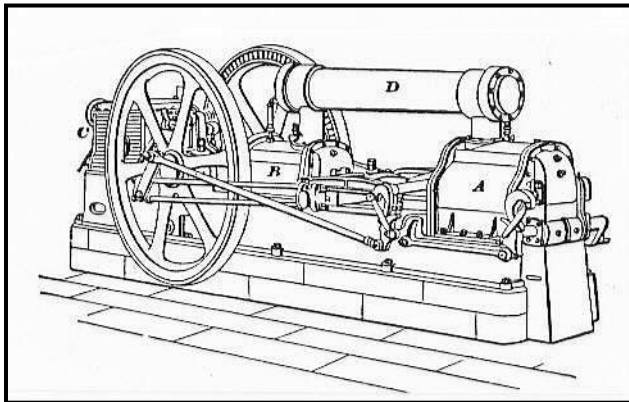


Illustration A 1.4.31: The line drawing depicts a straight-line steam compressor that provided two stages of compression. One compression cylinder is at right, another is at center, and the steam drive cylinder is at left. The flywheels imparted momentum to the machine. Source: International Textbook Company, 1899, A20:32.

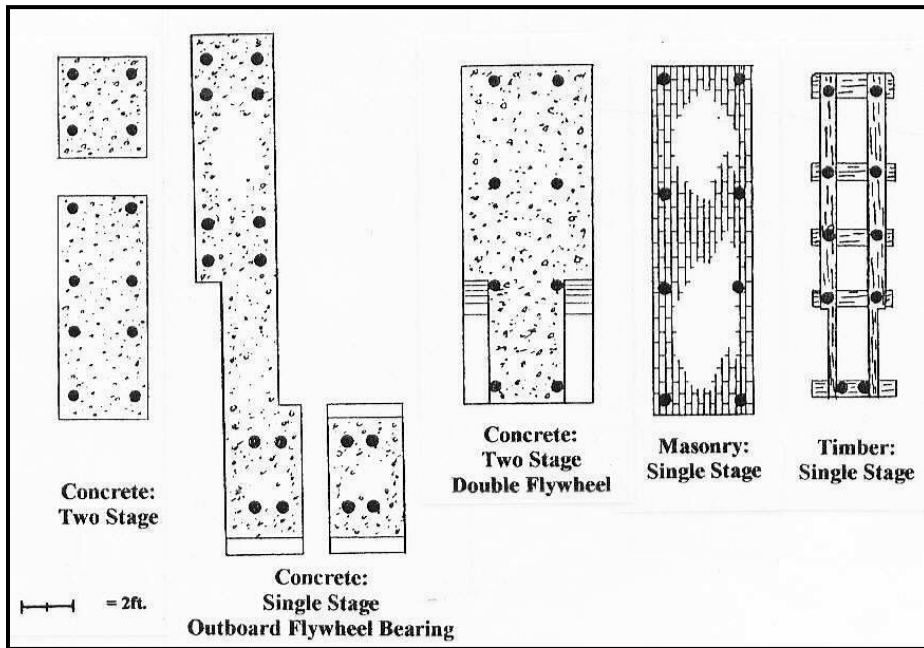


Illustration A 1.4.32: The plan view depicts foundations for straight-line compressors. Source: Eric Twitty, 1999.

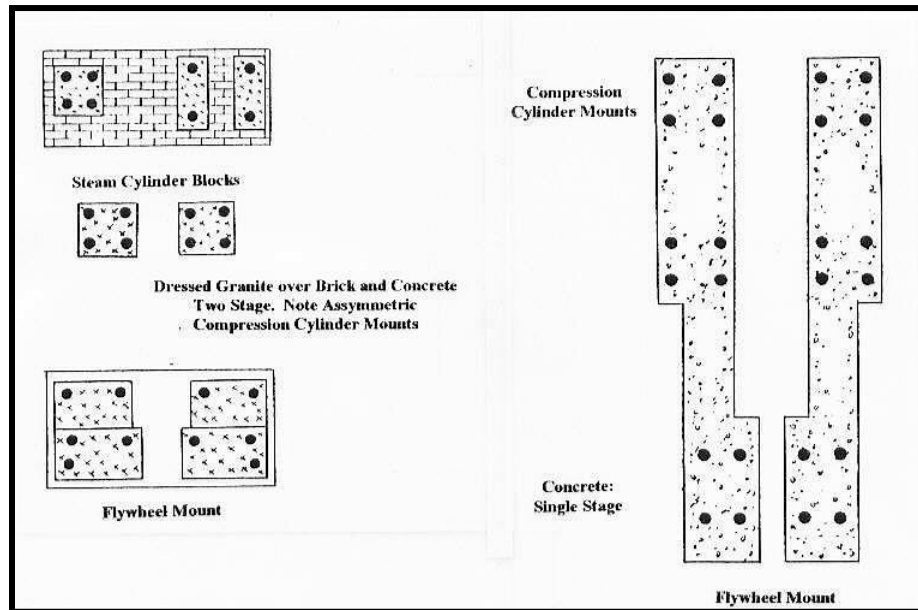
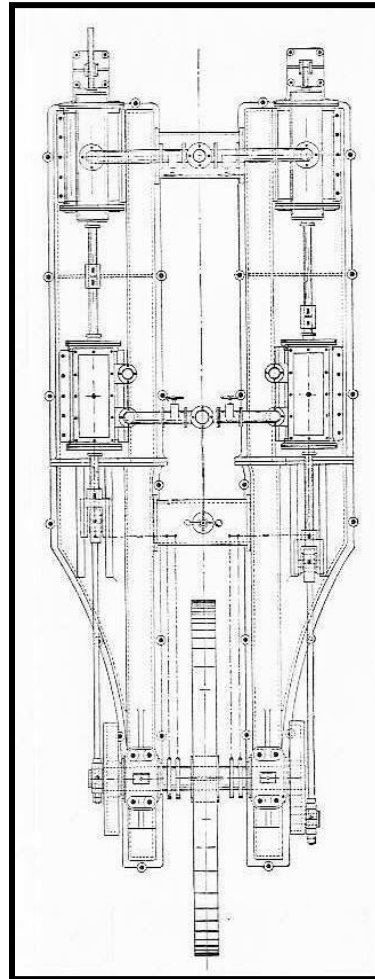


Illustration A 1.4.33: The plan views portray two common foundations for duplex steam compressors. The foundation at right was for a machine like the one above, and the foundation at left anchored a compressor with compound action. Source: Eric Twitty, 1999.

Illustration A 1.4.34: The plan view shows a typical pre-1910 duplex steam compressor. The compression cylinders are at top, the steam drive cylinders are at center, and the flywheel is at bottom. Source: Ingersoll Rock Drill Company, 1887:34.



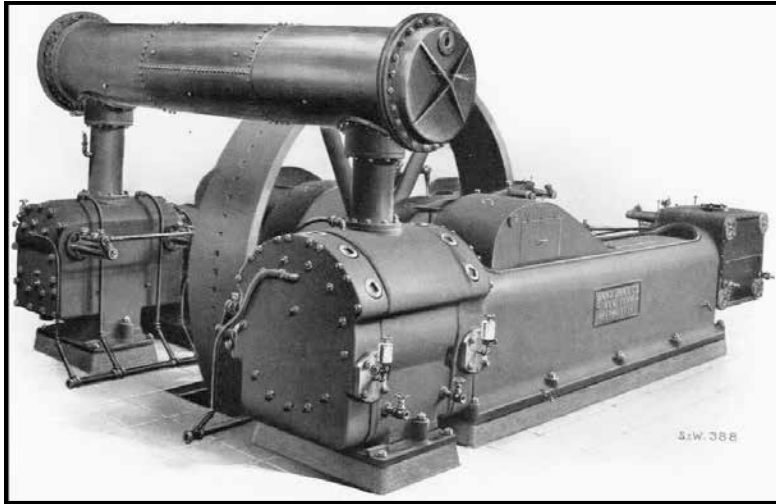


Illustration A 1.4.35: During the 1890s, the above form of duplex compressor became popular. Originally, these machines were powered by steam, and by 1905, some were also belted to motors where electricity was available. Source: Rand Drill Company, 1904:12.

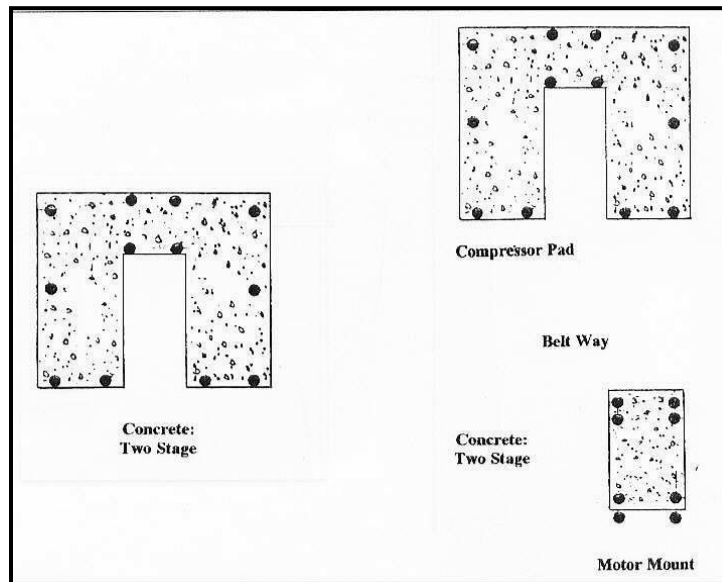


Illustration A 1.4.36: Compact duplex compressors were mounted to foundations like those in the above plan view. The foundation at left anchored a steam-powered unit, and the one at right was for a belted version, which became popular by the 1910s. Source: Twitty, 2002:109.

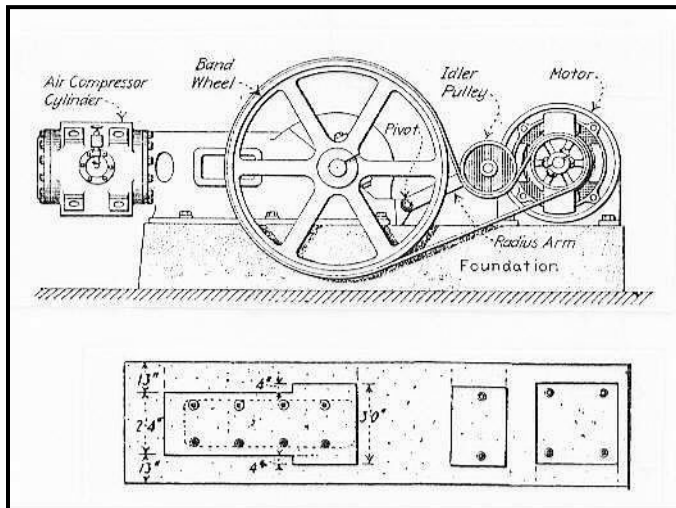


Illustration A 1.4.37: The profile illustrates the type of small, belted compressor popular between the 1910s and 1940s. The plan view shows the foundation, with mounts for the compressor and motor. Source: Eric Twitty, 1999.



Illustration A 1.4.38: The V-cylinder compressor, similar to a large engine, became one of the most popular compressor types during the 1930s. Note the foundation. Source: Eric Twitty, 1999.

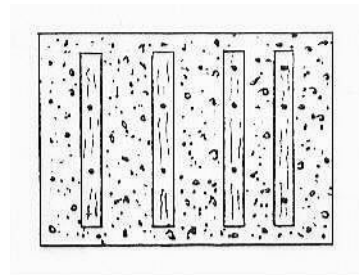


Illustration A 1.4.39: The illustration at left is a plan view for a V-cylinder compressor foundation. Timber footers are embedded in a concrete rectangle around 3'x4' in area. Source: Eric Twitty, 1999.



Illustration A1.4.40: The buildings at the Mendota Mine, Silver Plume, are typical of professionally designed, vernacular architecture specific to the mining industry. The building with smokestack is a tunnel house enclosing a blacksmith shop, air compressor and boiler, and tunnel portal. The other buildings are an office and more shop space. The buildings were probably custom-designed by a company official for function and economy, rather than appearance. Board-and-batten siding and shingle roofing was common into the 1910s, when corrugated sheet iron became universal. Courtesy of Denver Public Library, X-61693.

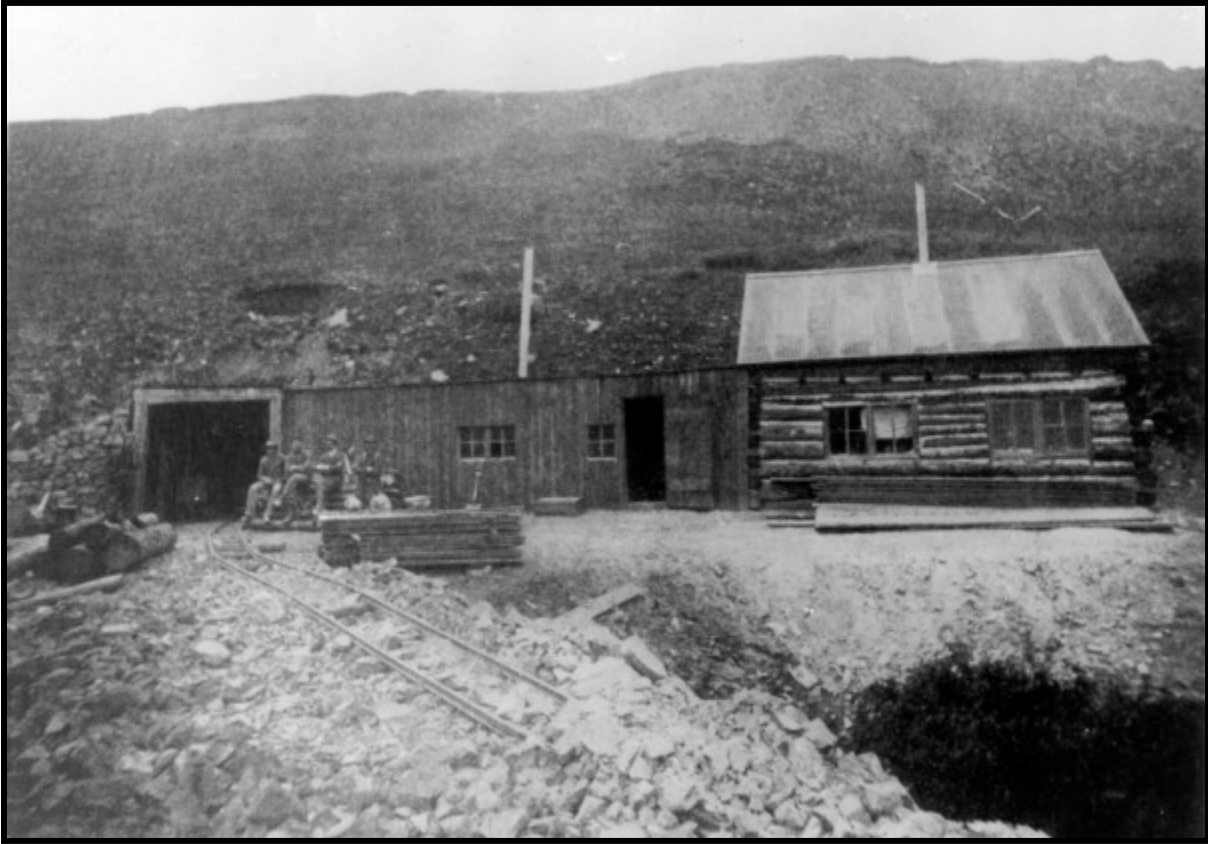


Illustration A 1.4.41: The buildings at the Vidler Tunnel, Argentine Mining District around 1905, are typical architecture at most mines. They were small and rough even when new, and not designed or constructed by professionals. Instead, miners planned them on-site to meet immediate needs, invested little capital, and used available materials. The building at left is a shed-type tunnel house with timber shop, and the log cabin at right may have been a blacksmith shop. The mine lacked machinery. Courtesy of Denver Public Library, X-61712.

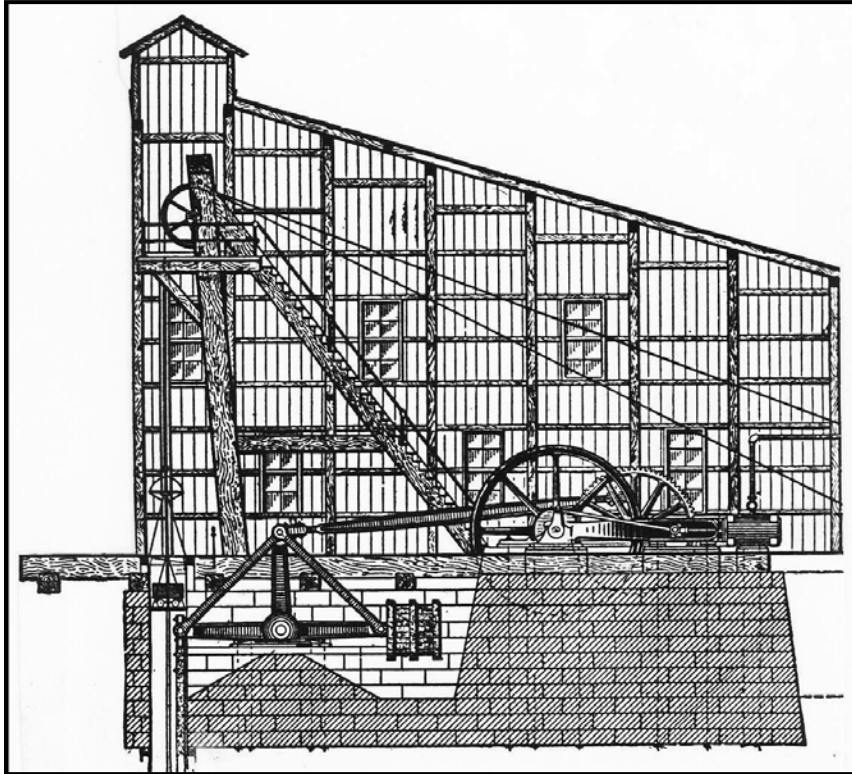


Illustration A 1.4.42: Shaft houses enclosed the shaft collar, headframe, hoist, power system, and usually the blacksmith shop. The shaft house in the profile also features a Cornish pump and steam engine, rarely used in Clear Creek County. Source: International Textbook Company, 1899, A43:3.

Illustration A 1.4.43: After shaft houses were outlawed during the 1910s, mining companies erected hoist houses to enclose critical facilities. In this Boulder County example dating to the 1930s, the left roofline features an angled cupola for the hoist cable, which ascended to a headframe left and out of view. Source: Eric Twitty, 2003.

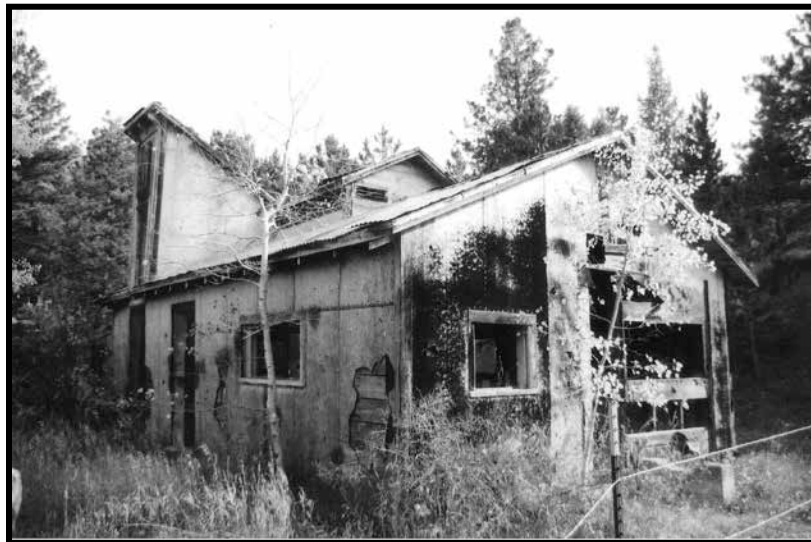




Illustration A 1.4.44: At the Pay Rock Mine near Silver Plume, a Hallidie tramway lowered ore from workings high on the mountainside down to a bottom terminal and loading station. The sheave wheel is enclosed in the slanted frame above the ore bin. The towers are unusual tripod structures. Courtesy of Denver Public Library, CHS.X4578.

Ore Beneficiation: Smelting, Ore Concentration, and Amalgamation

Smelters

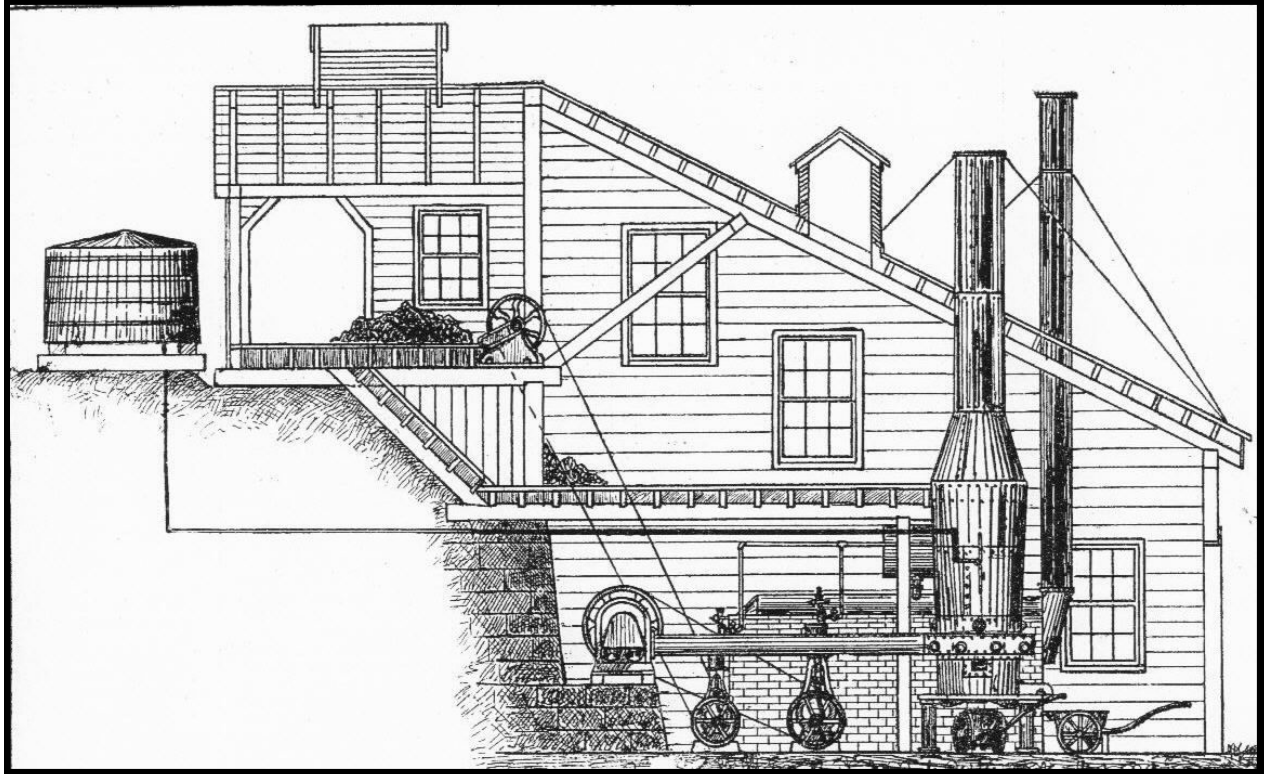


Illustration A 1.445: The profile illustrates a small and simple smelter. Workers sorted crude ore at top left and then fed the material into a crusher marked by the upper wheel, which is a belt pulley. The resultant cobbles and gravel accumulated on the floor at center, and workers periodically fed the material into the furnace at lower right. The type of furnace, free-standing and pre-fabricated, was common by the late 1870s. Note the blower system in front of the brickwork at bottom, which forced air into the furnace for great heat. Early smelters featured masonry furnaces instead of the free-standing unit. In many cases, smelters also had concentration machinery to process complex ore in advance. Source: *Mining & Scientific Press* (4/28/83), p281.

Concentration Mills

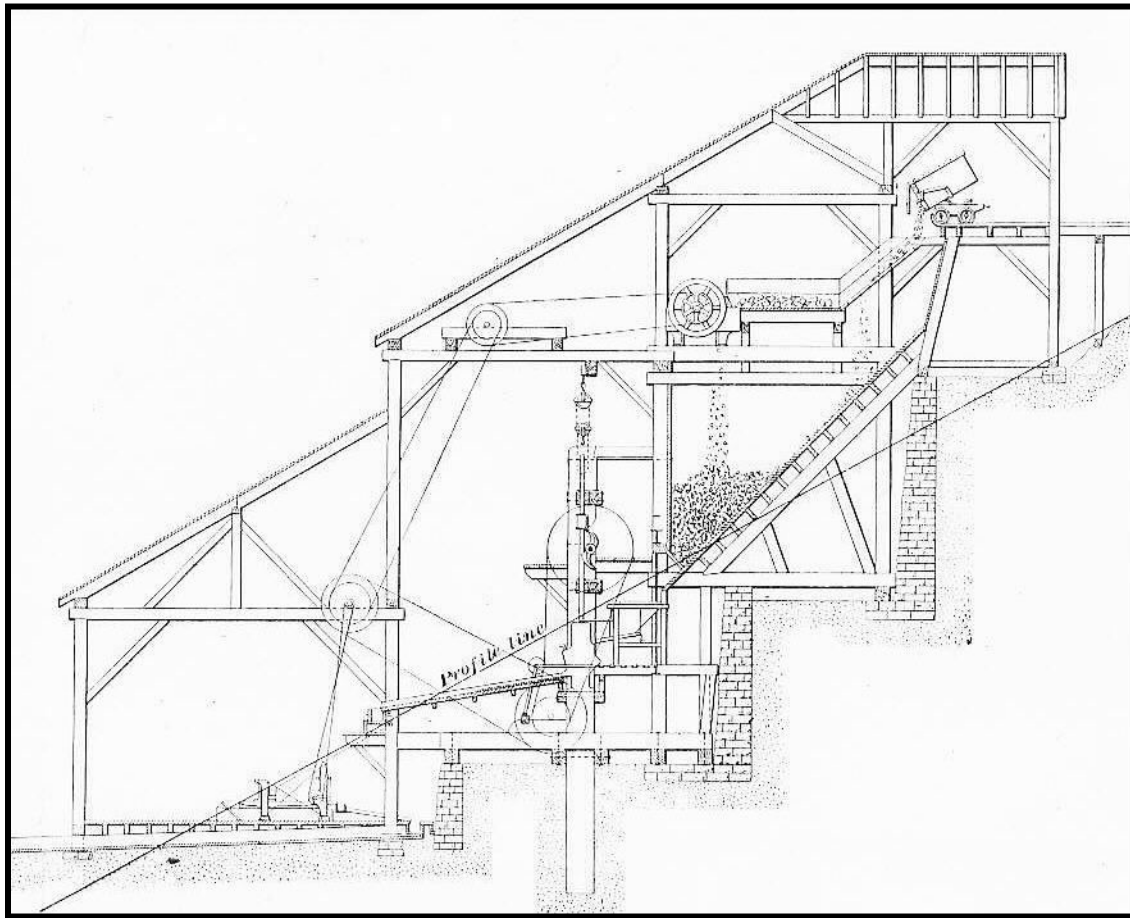


Illustration A 1.4.46: The profile illustrates both the stairstep configuration of a typical concentration mill and the process flow path. Workers dumped ore onto a screen at top, and fine material passed through while course cobbles were diverted into a crusher. A stamp battery at center then pulverized the ore into a slurry, which passed over amalgamating tables that extracted free-gold and silver. The slurry then descended to concentration machinery on the lower platform. That machinery separated out the gold and silver that refused to amalgamate. Source: International Textbook Company, 1899, A43:214.

Crushing Machinery

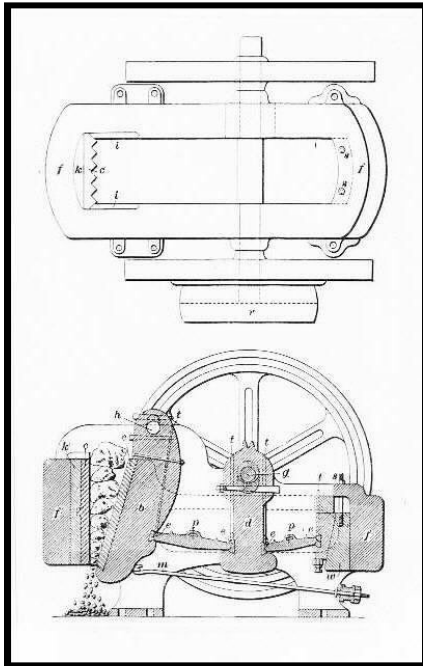
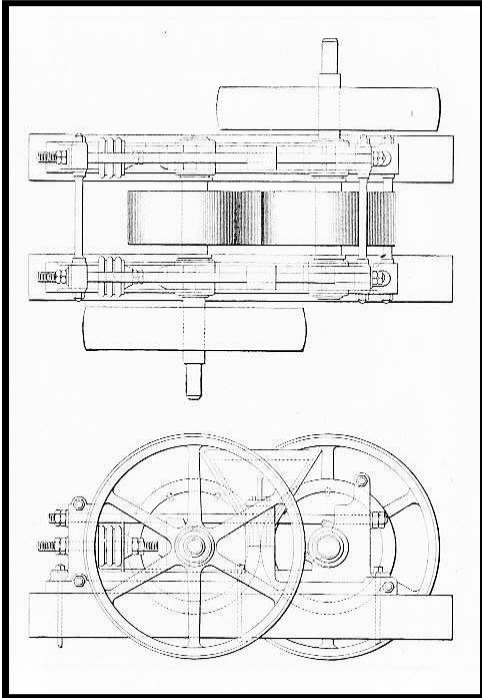


Illustration A 1.4.47: The plan view, top, and profile, bottom, illustrate a jaw crusher, which provided initial crushing at most mills. Source: International Textbook Company, 1899, A43:2.

Illustration A 1.4.48: The plan view, top, and profile, bottom, illustrate a device known as a crushing rolls, which was popular for secondary and tertiary crushing. Source: International Textbook Company, 1899, A43:12.



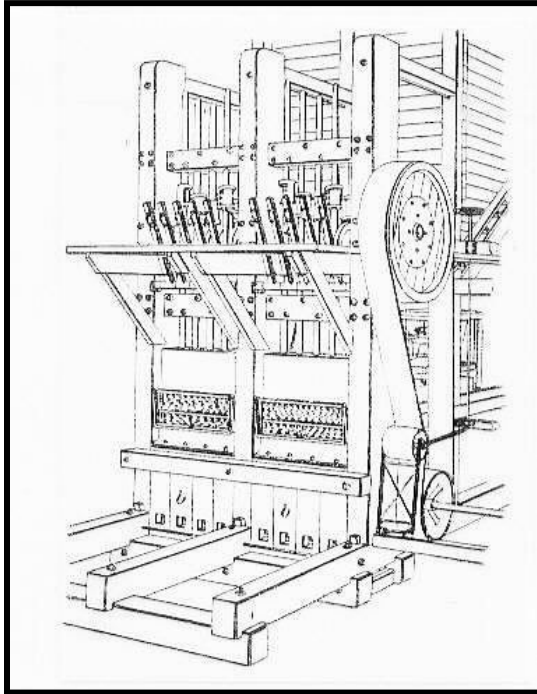


Illustration A 1.4.49: The quarter view illustrates the front of a stamp battery, which provided secondary crushing at some mills. Stamp rods are visible between the timber posts, and their heavy iron shoes pounded ore in the battery boxes below. The battery boxes are bolted to pedestals of upright timbers, which are often the only remnants of stamp batteries today. Source: International Textbook Company, 1899, A43:27.



Illustration A 1.4.50: When a stamp battery was dismantled, the pedestals for the cast iron battery boxes were often left in place. The pedestals consist of timbers on-end and feature anchor bolts on top, and each is around 2' wide, 3' high, and 5' long. Source: Eric Twitty, 2009.

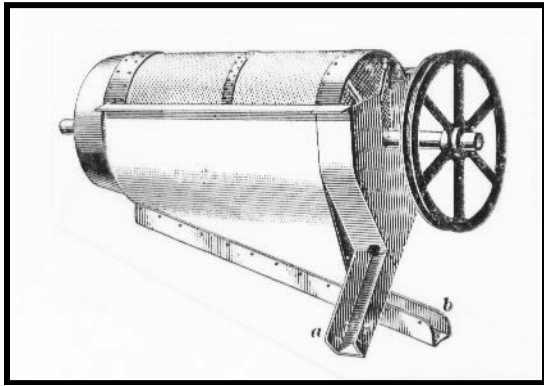


Illustration A 1.4.51: Most mills relied on trommel screens to sort crushed rock between processing stages. Source: International Textbook Company, 1899, A43:12.

Illustration A 1.4.52: The Huntington mill saw two applications. At concentration facilities, it provided secondary and tertiary crushing, and at amalgamation mills, the device simultaneously ground and amalgamated gold and silver ores. The driveshaft at right turned a capstan in the mill's pan, which caused the rollers to grind screened ore against the cast iron walls. Note the timber foundation. Source: International Textbook Company, 1899, Z43:47.

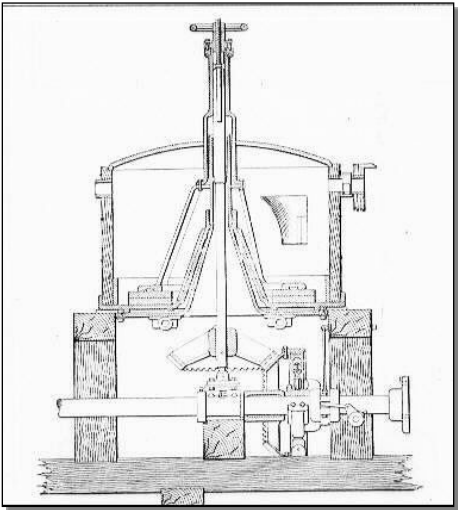
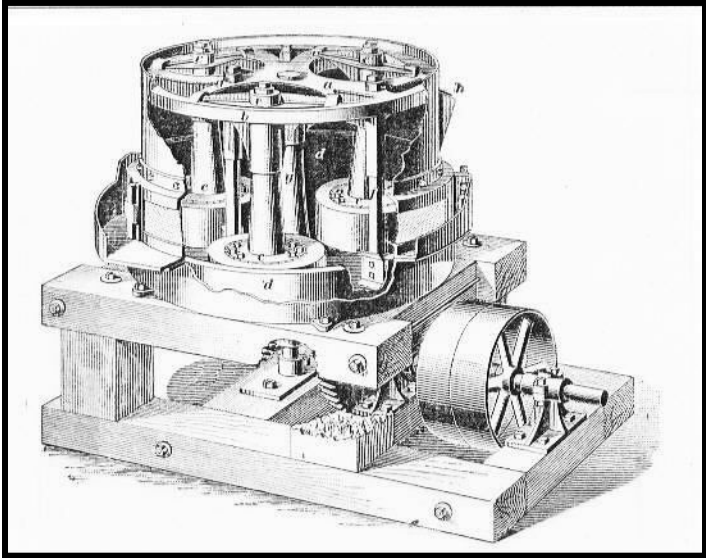


Illustration A 1.4.53: The profile depicts a grinding pan, used for tertiary crushing and sometimes to amalgamate gold ore. Heavy shoes on a central axle rotated around the cast iron floor and ground ore. They were largely ineffective on complex ore. Source: International Textbook Company, 1899, A43:172.

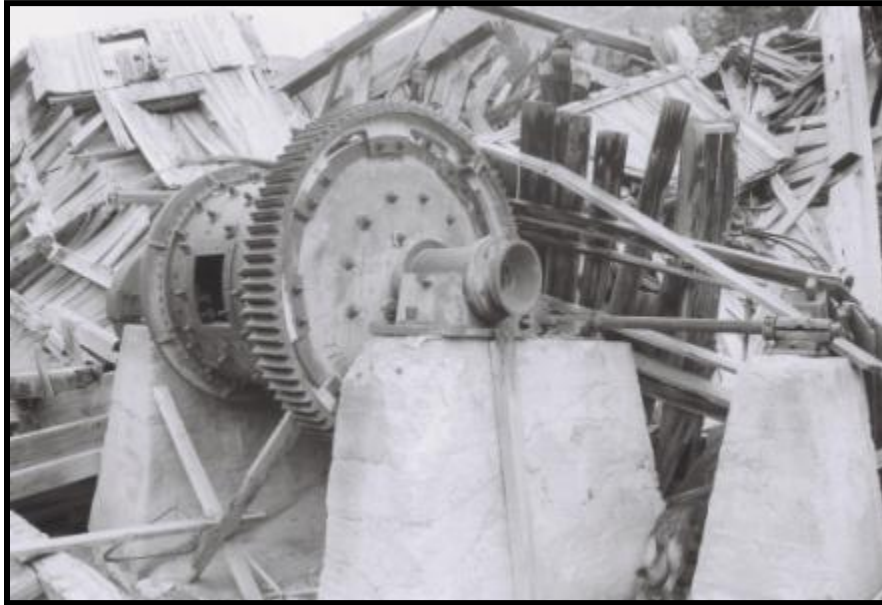
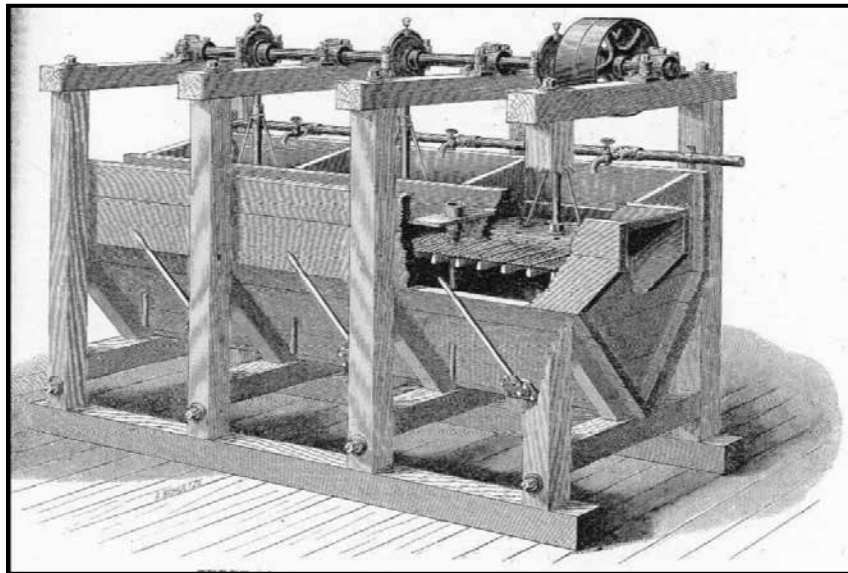


Illustration A 1.4.54: Ball mills became popular for fine grinding by the 1910s. As the entire cylinder slowly rotated, tumbling steel balls in the chamber ground screened ore to a slurry. A hatch covered the opening.. Note the concrete foundation, distinct in footprint. Source: Eric Twitty, 2009.

Concentration Machinery

Illustration A 1.4.55: The jig was an effective and popular concentration device from the 1870s through 1905. The crank at top moved screen plungers up and down in the slurry-filled cells. The agitating action classified ore particles by size or weight, depending on the application. Source: *Mining & Scientific Press* (8/9/90), p83.



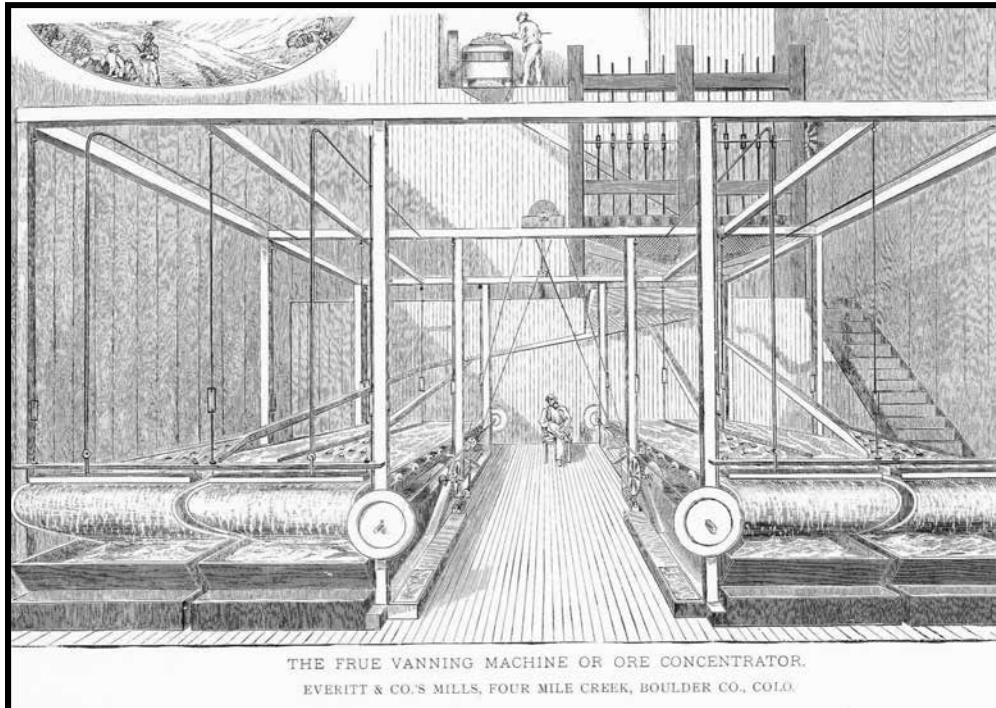


Illustration A 1.4.56: Frue vanners were used with some success to concentrate complex silver ore prior to 1900, although the drawing is of the Everett Mill in Boulder County. As the vanner vibrated, finely ground ore settled against its broad rubber belt while water jets and a scraper removed light waste material. Note the stamp battery at upper right. Source: *Engineering & Mining Journal* (11/24/77), p387.

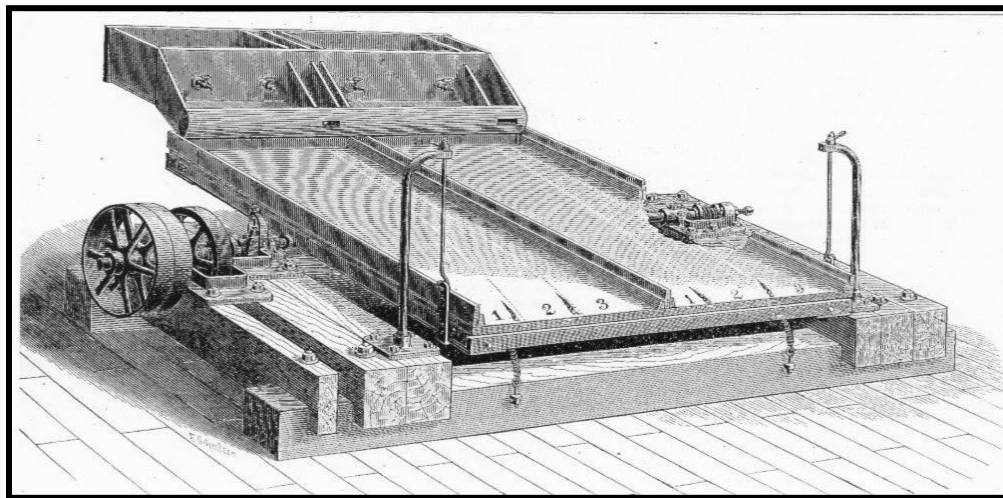


Illustration A 1.4.57: Known as both a percussion table and a bumping table, this 1880s apparatus used vibratory action to concentrate finely ground silver ores. Source: *Mining & Scientific Press* (8/9/90), p83.

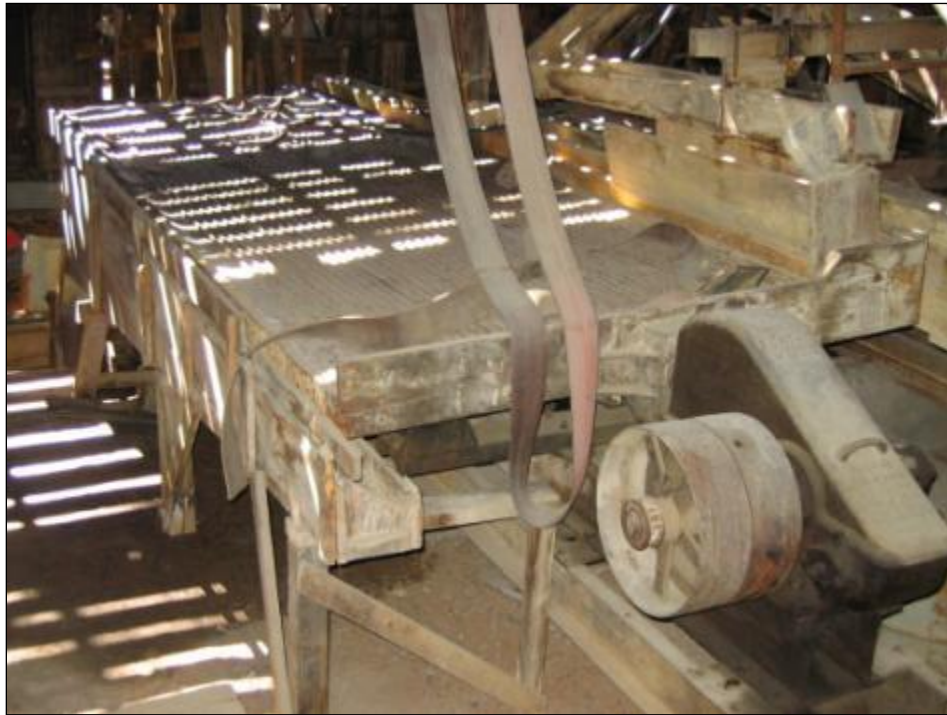


Illustration A 1.4.58: Following introduction around 1898, the vibrating table was one of the most popular and effective concentration appliances throughout the Rocky Mountain west. An eccentric cam under the guard at right imparted a vibrating motion to the tabletop, causing heavy metalliferous material to settle against the riffles. Water currents washed the light waste off. Source: Carol Beam, Boulder County Parks and Open Space, 2008.



Illustration A 1.4.59:

Vibrating tables like the one in Figure A 58 above were anchored to foundations of three concrete or timber footers, often 5' wide and 15' long. Source: Eric Twitty, 2008.



Illustration A 1.4.60: The Alma Lincoln Mill near Idaho Springs was equipped with a battery of flotation cells. Highly efficient, the apparatuses replaced other types of concentration machinery by the 1930s, when the mill was built. The cells were filled with slurry and agitated to a froth. Courtesy of Denver Public Library, CHS.X5495.

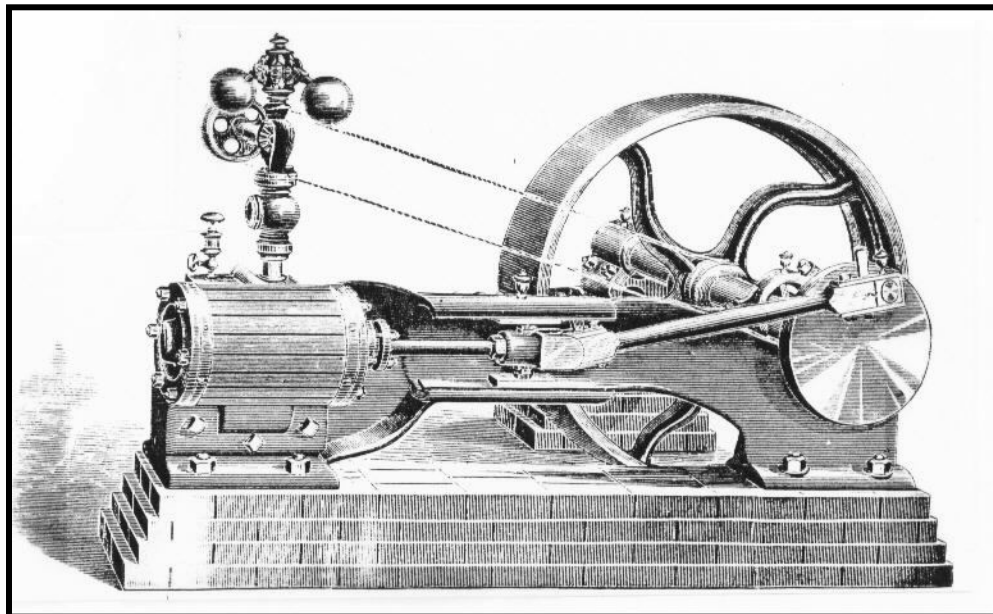


Illustration A 1.4.61: Until electricity became available during the 1890s, horizontal steam engines powered nearly all concentration mills. A drive belt passed around the flywheel to a mill's system of driveshafts. Note the masonry foundation. Source: Ingersoll Rockdrill Company, 1887:53.



Figure A 1.4.62: By the 1890s, mining companies increasingly used electric motors to power their mills, provided electricity was available. This motor is at the Kittimac Mine, San Juan County. Source: Eric Twitty, 2007.

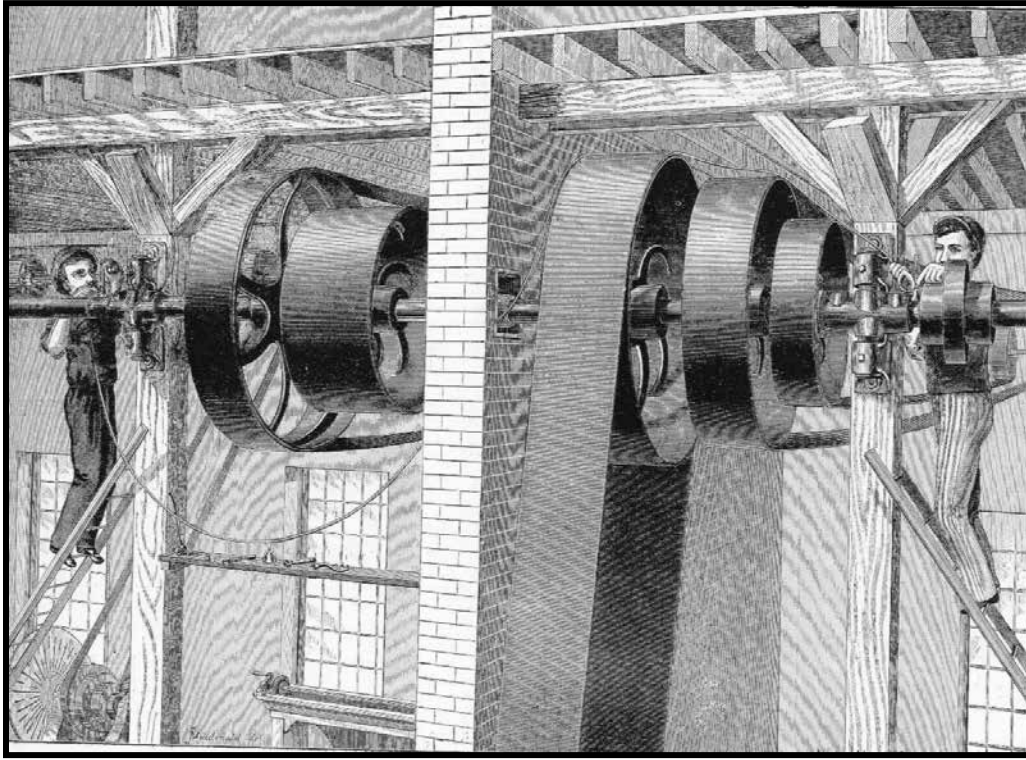


Illustration A 1.4.63: A system of overhead driveshafts and belts was the most common means of transferring motion from a mill's engine to its various appliances. Source: *Mining & Scientific Press* (9/1/83), p129.

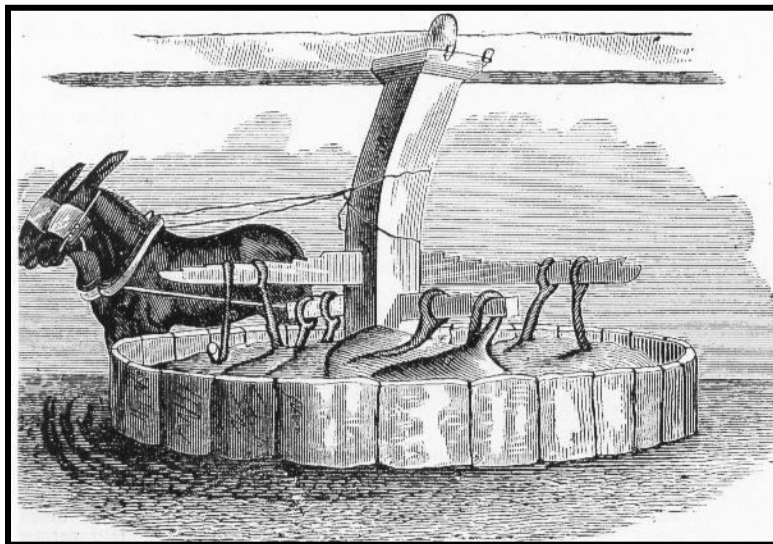


Figure A 1.4.64: The ages-old arrastra was used during the earliest years of mining in San Juan County to treat gold ore. The operator shoveled ore into the interior, added mercury, and waited for the rotating muller stones to grind the material into sand and slurry. As the ore fractured, mercury amalgamated with the gold. Because arrastras were simple and inexpensive, they were favored by prospectors. Source: *Mining & Scientific Press* (5/26/83).

Section A 2: History of the Timber Industry, 1860-1920

Overview of Forest Products



Illustration A 2.1: The Wapiti Sawmill typifies most lumber facilities in the I-70 Mountain Corridor. Workers rolled logs from a stockpile in the foreground onto a dolly in the mill, before feeding them into saw-blades. The dolly is at right, and the saw-blades, steam engine, and boiler are in the building at center. The mill, in this northerly view, operated between Breckenridge and Dillon for the Victoria Mining Company around 1890. Courtesy of Denver Public Library, X4929.

Land Use Policy and the Timber Industry

Illustration A 2.2: Lumber companies and railroad tie hacks neatly complimented each other in impact on forests, harvesting all but the smallest trees. The resulting clearcuts, such as the one around Bakerville on Clear Creek, spurred the federal government to regulate logging in forest reserves, which became national forests. Bakerville, in this late 1860s south view, depended on logging as much as mining. Courtesy of Denver Public Library, Z-2557.

The Timber Industry in Clear Creek Drainage

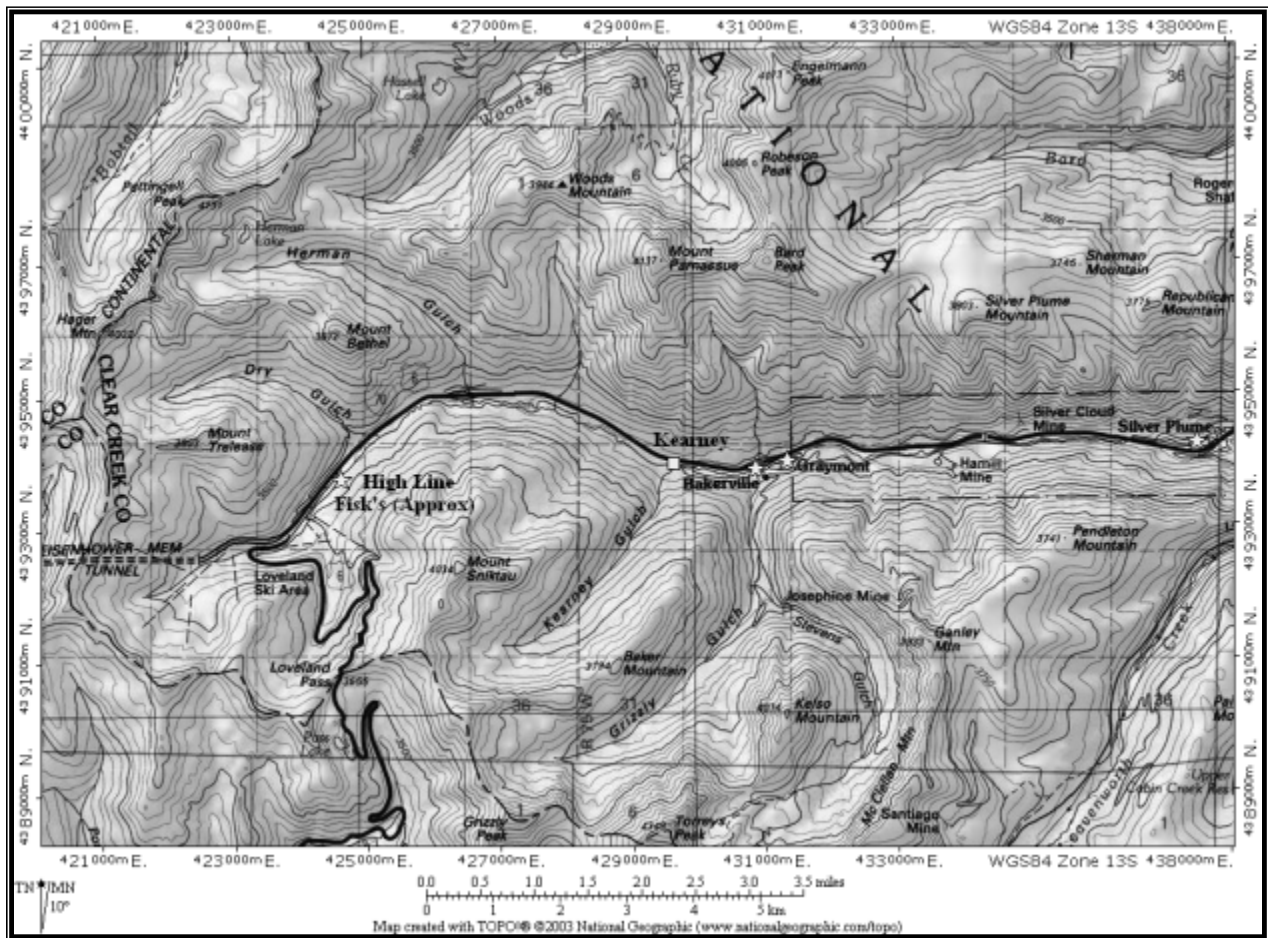


Illustration A 2.3: The map illustrates the center of lumber production in western Clear Creek drainage, and its principal geographic points. High Line, Kearney, Bakerville, and Graymont (stars) were sawmill communities, while independent plants operated at the mouths of drainages in between. The location of High Line, originally known as Fisk's Junction, is approximate and indefinite. Source: National Geographic TOPO! digital map (on CD).

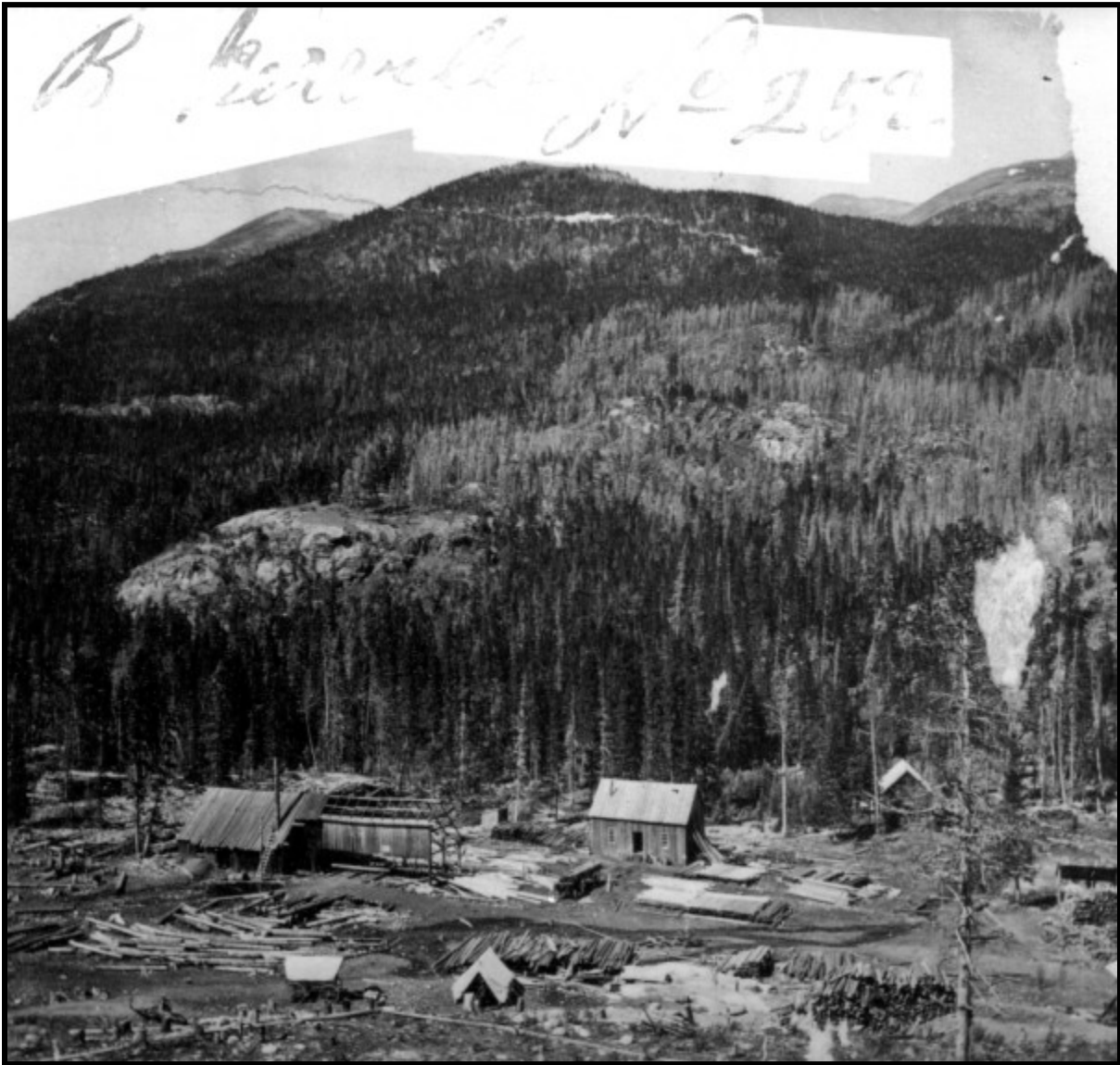


Illustration A 2.4: Arrival of the Colorado Central Railroad at Georgetown in 1877 opened upper western Clear Creek drainage to intensive logging. Bakerville, established during the 1860s as a mining hamlet, became the drainage's sawmill center. In this circa 1870 southern view, a sawmill operates on the valley floor a short distance east of Bakerville. Courtesy of Denver Public Library, X-7157.



Illustration A 2.5: The Clear Creek Flume, left, and Georgetown, Breckenridge & Leadville Railroad, right, granted lumber companies in upper Clear Creek drainage two means of shipping forest products to market. As a result, lumber companies quickly exhausted the forests, evident by the large clear cuts in the background of this 1885 photo of the Bakerville area. Courtesy of Denver Public Library, CHS-J882.

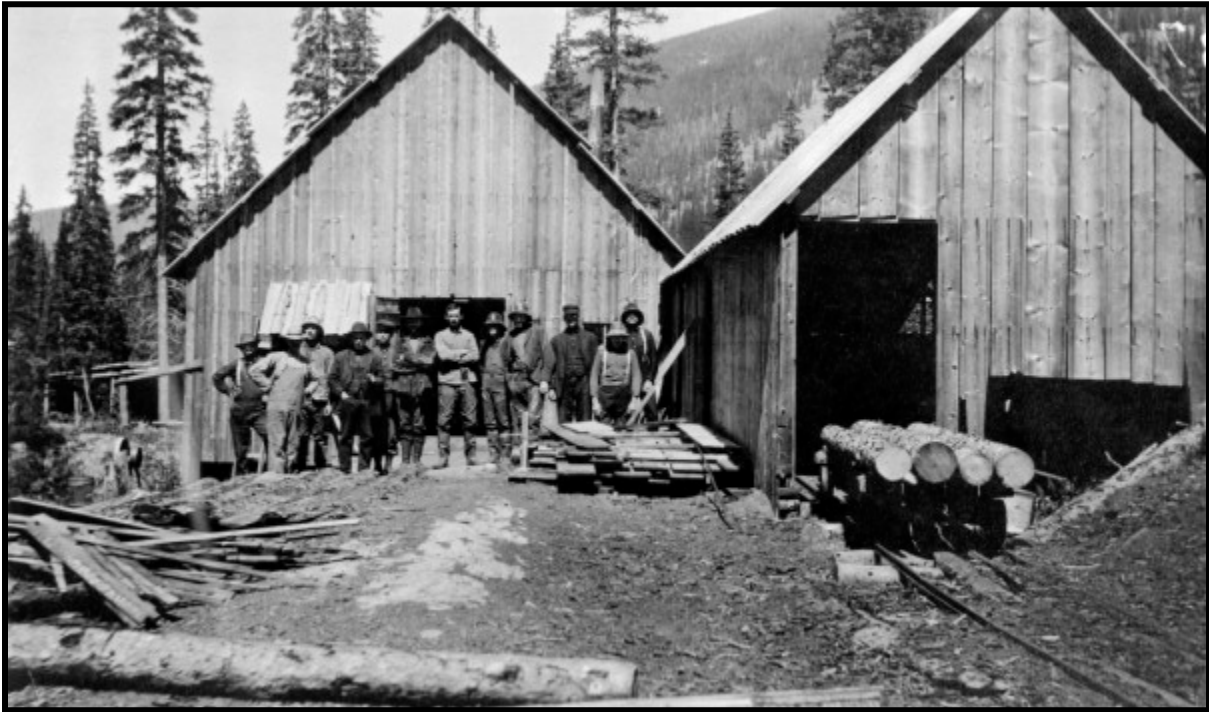
The Timber Industry in Eagle River Valley

Illustration A 2.6: Eagle was center to a small logging industry. Most sawmills, such as the East Lake facility in 1908, were located in forests on the surrounding mountains. But their forest products flowed through Eagle, onto the Denver & Rio Grande Railroad, and to market. Courtesy of Denver Public Library, X-8015.

Section A 3: History of High-Altitude Agriculture, 1860-1960

Illustration A 3.1: This bunker-like structure in the Colorado River valley, photographed during the 1880s, is a typical homesteader's dugout. Its primitive façade and lack of windows indicate that it was temporary, later to be replaced by a cabin or house. Courtesy of Denver Public Library, CHS.J959.

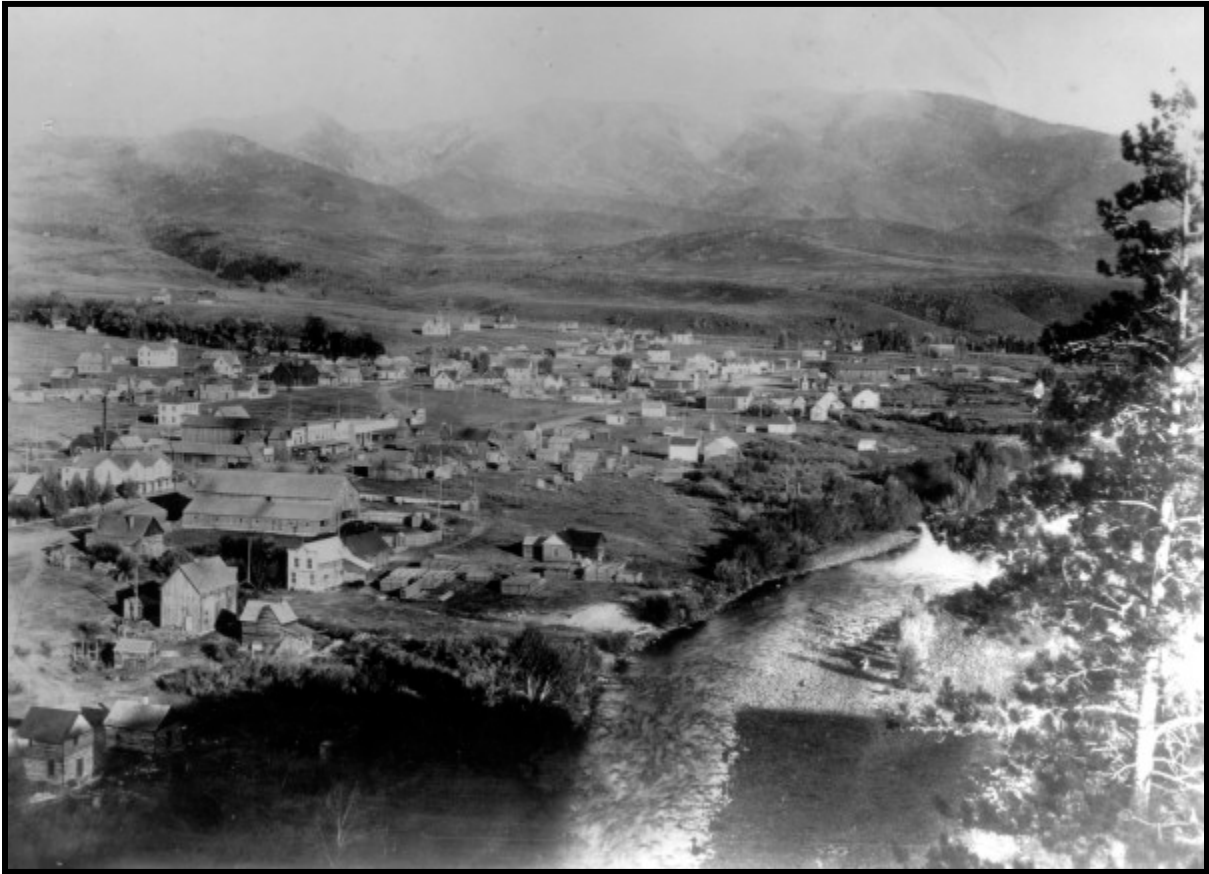


Illustration A 3.2: Agriculture, and especially ranching, made Eagle an important town in western Colorado during the 1880s, when this photo was taken. Ranches surrounded the town. Courtesy of Denver Public Library, X-8003.

Section A 4: History of Electric Power Generation, 1883-1962

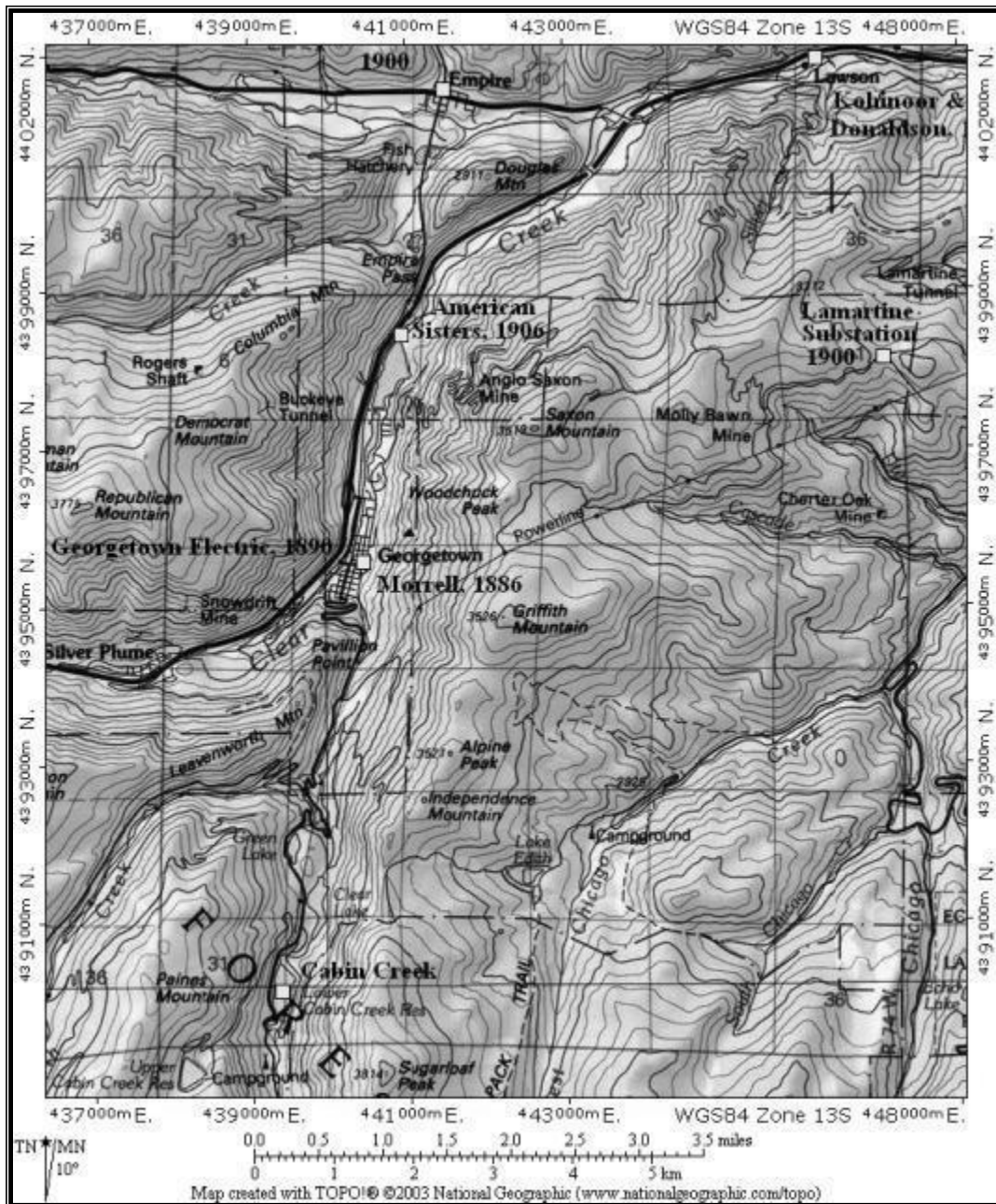


Illustration A 4.1: The map illustrates approximate locations of powerplants (boxes) and their founding dates in western Clear Creek drainage. I-70 is the dark line forming an S along Clear Creek. Source: National Geographic TOPO! digital map (on CD).

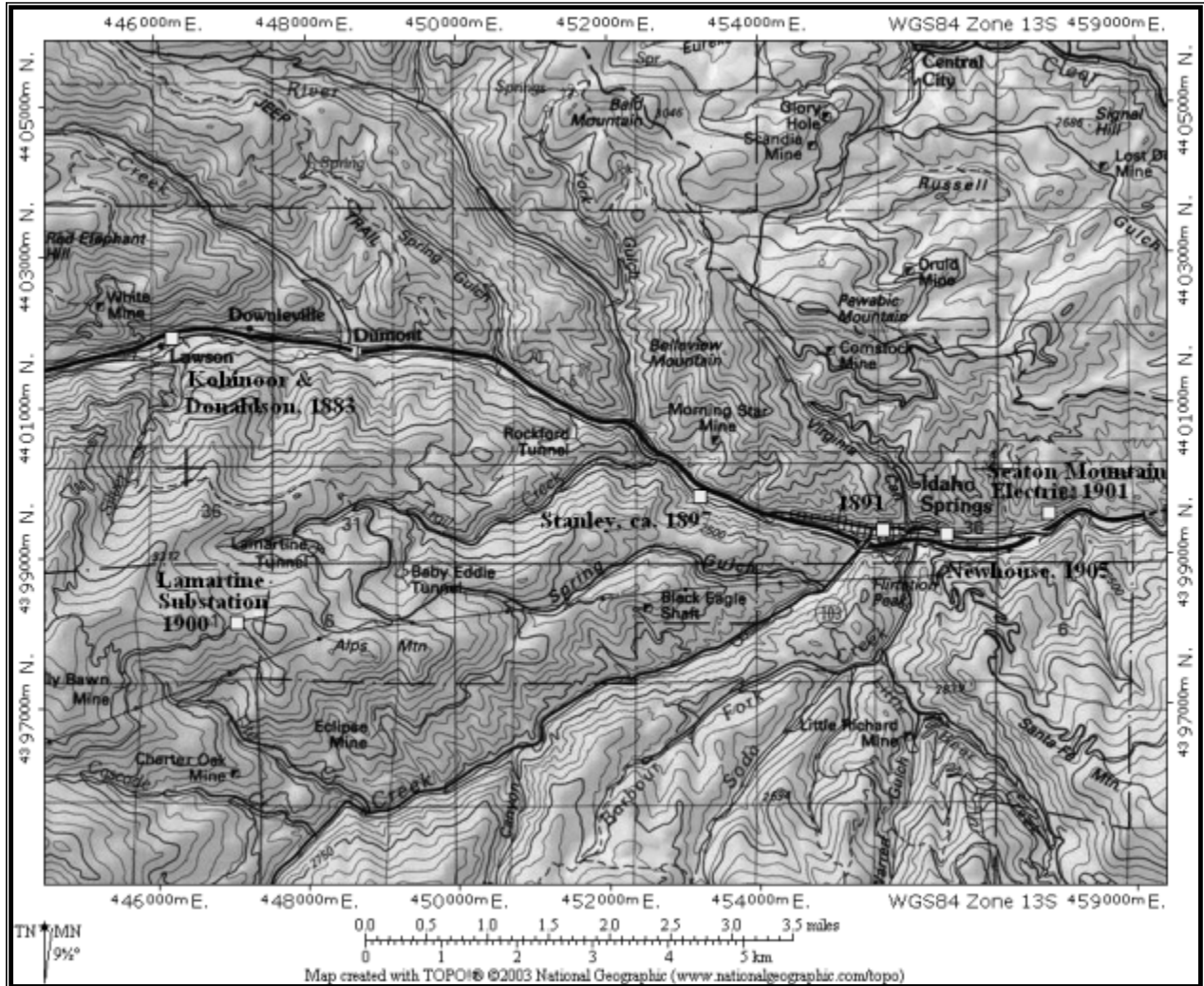


Illustration A 4.2: The map illustrates approximate locations of powerplants (boxes) and their founding dates in eastern Clear Creek drainage. I-70 is the dark line crossing east to west. Source: National Geographic TOPO! digital map (on CD).

Beginning of Clear Creek Electric Grid, 1883-1905

Illustration A 4.3: Mining companies gradually replaced old steam equipment with motorized versions, such as this belt-driven air compressor at the Clear Creek Consolidated operation near Idaho Springs around 1900. Motors saved companies the costs of installing boilers and feeding them coal. Courtesy of Denver Public Library, X-63213.



Illustration A 4.4: In 1900, United Light & Power built this Alternating Current hydro-plant in Georgetown as part of an expansion campaign to reach more mines in western Clear Creek drainage. The plant, among several others operated by the company, still functions. Courtesy of Denver Public Library, X-1029.

Beginning of the Ten Mile and Dillon Electric Grid, 1898-1906

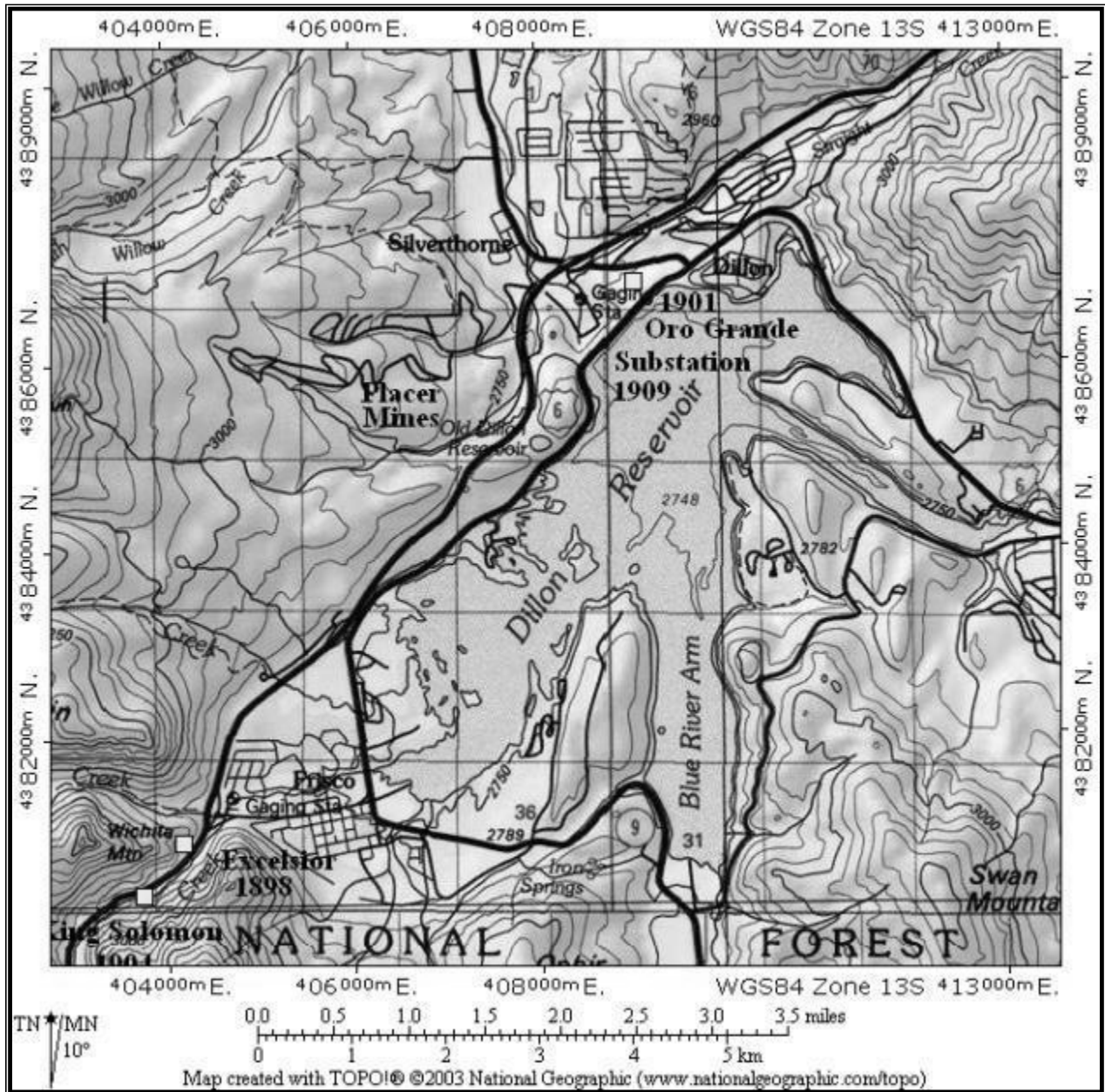


Illustration A 4.5: The map illustrates approximate locations of powerplants (boxes) and their founding dates around Dillon and Frisco. I-70 is the dark line crossing northeast to southwest. Source: National Geographic TOPO! digital map (on CD).

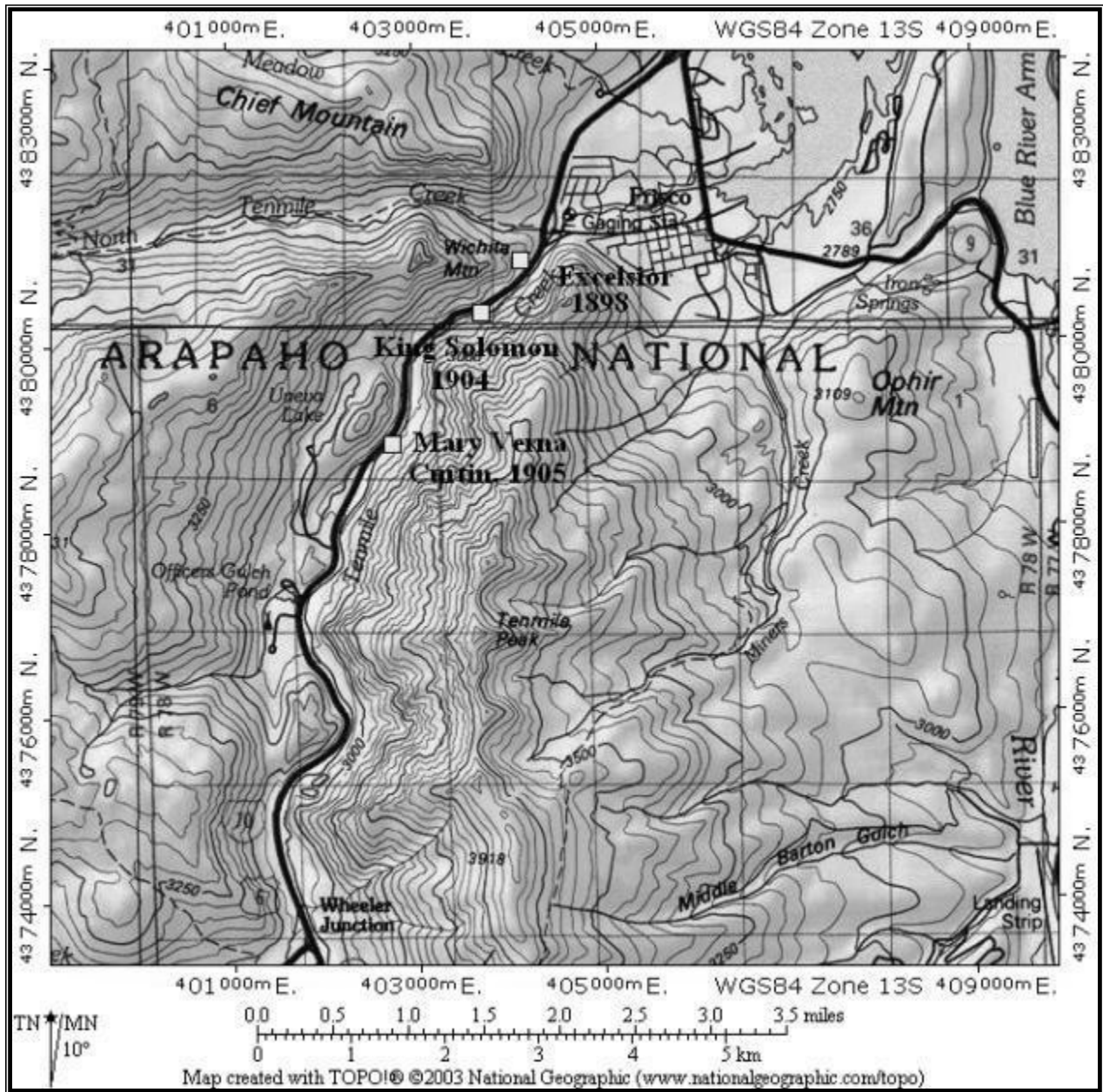


Illustration A 4.6: The map illustrates approximate locations of powerplants (boxes) and their founding dates in Ten Mile Canyon south of Frisco. All were built by mining companies for in-house use, but the Excelsior plant also served Frisco and the Mary Verna plant Curtin. Other plants existed in the canyon at unknown locations. I-70 is the dark line in the canyon. Source: National Geographic TOPO! digital map (on CD).



Illustration A 4.7: In the first decade of the twentieth century, the Dillon and Frisco area lacked a coordinated grid. Instead, several mining companies built their own powerhouses to provide electricity for themselves and associated communities. The Mary Verna Powerhouse generated for the Mary Verna and North American mines, and the settlement of Curtin. The powerhouse in this circa 1910 photo by Otto Westerman is a typical steam plant of the era. Courtesy of Denver Public Library, X-62730.

Central Colorado Power Company's Shoshone Plant, 1906-1909

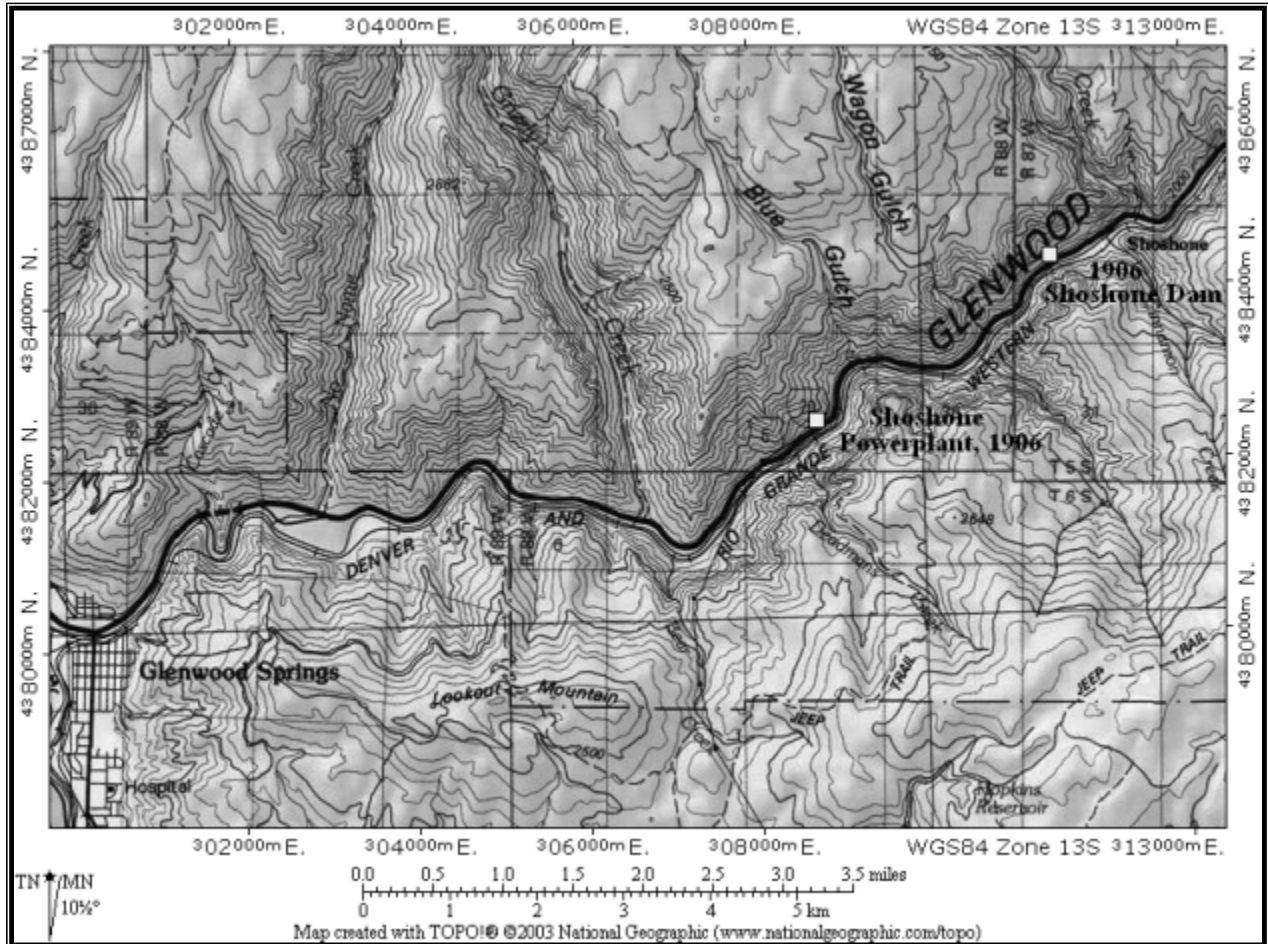


Illustration A 4.8: The map illustrates the Shoshone Dam and Powerplant, and their founding dates. Each facility supported a temporary workers' camp, the one associated with the dam still bearing the project name. The camp at the powerplant was largest with a Shoshone post office, but has been dismantled. I-70 is the dark line crossing northeast to southwest. Source: National Geographic TOPO! digital map (on CD).



Illustration A 4.9: In 1906, the Central Colorado Power Company erected the settlement of Shoshone on the left (south) side of the Colorado River to house workers building a massive hydro-plant on the right side. The camp was no longer needed after they finished in 1911, so the company dismantled it. Courtesy of Denver Public Library, MCC.3804.



Illustration A 4.10: The Shoshone Dam, on the Colorado River several miles above the powerhouse, was an engineering achievement. Steel gates known as bear traps could be raised or lowered, depending on river flow, to ensure diversion into the powerplant's intake tunnel in the cliff at the left side. Charles McClure captured the upstream view in 1910. Courtesy of Denver Public Library, MCC-3850.



Illustration A 4.11: The Shoshone powerhouse, under construction in this Charles McClure 1908 photo, became the western terminus of a grid linking most of the principal towns in the central mountains. Water diverted from a dam upriver flowed through the tunnel in the cliff above, down through the penstocks, and into the building. Although modified, the system is still in operation today. Courtesy of Denver Public Library, MCC-3397.

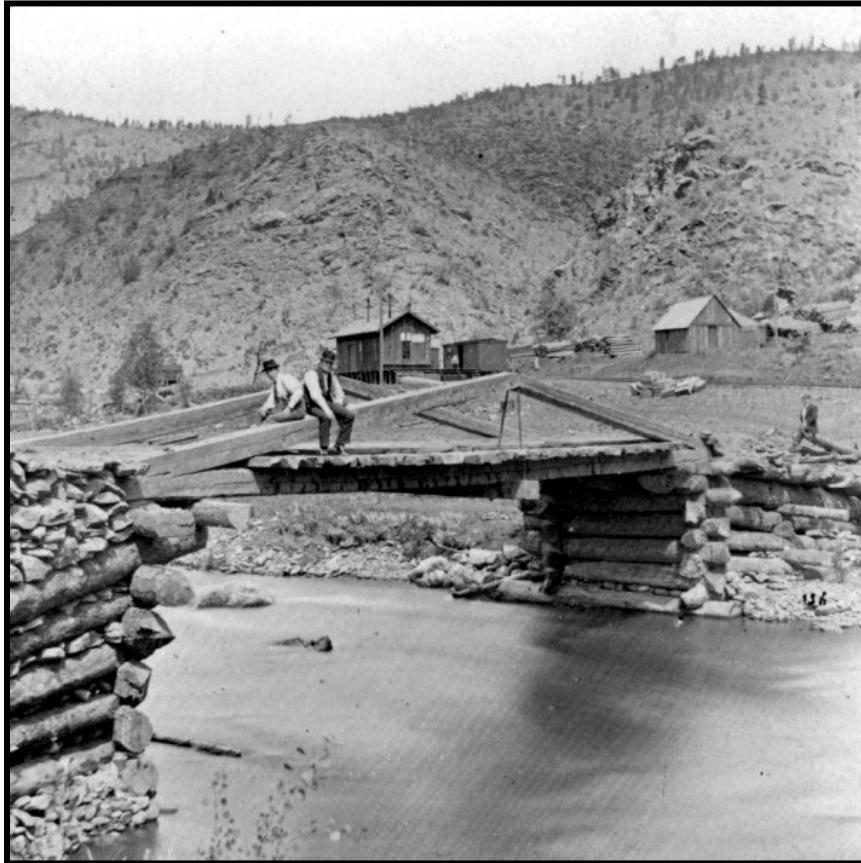
Section A 5: History of Railroad Transportation, 1873-1962**Colorado Central Railroad: Expansion, 1871-1876**

Illustration A 5.1: When the Colorado Central Railroad reached the base of Floyd Hill in 1873, it stopped construction and established a railhead. Expecting the railroad to reach Georgetown, Clear Creek residents were disappointed in the suspension. Regardless, the railhead revolutionized industry, quality of life, and the economy by reducing transportation costs and time. Courtesy of Denver Public Library, X-8461.

Colorado Central Railroad: Georgetown Extension, 1877-1880

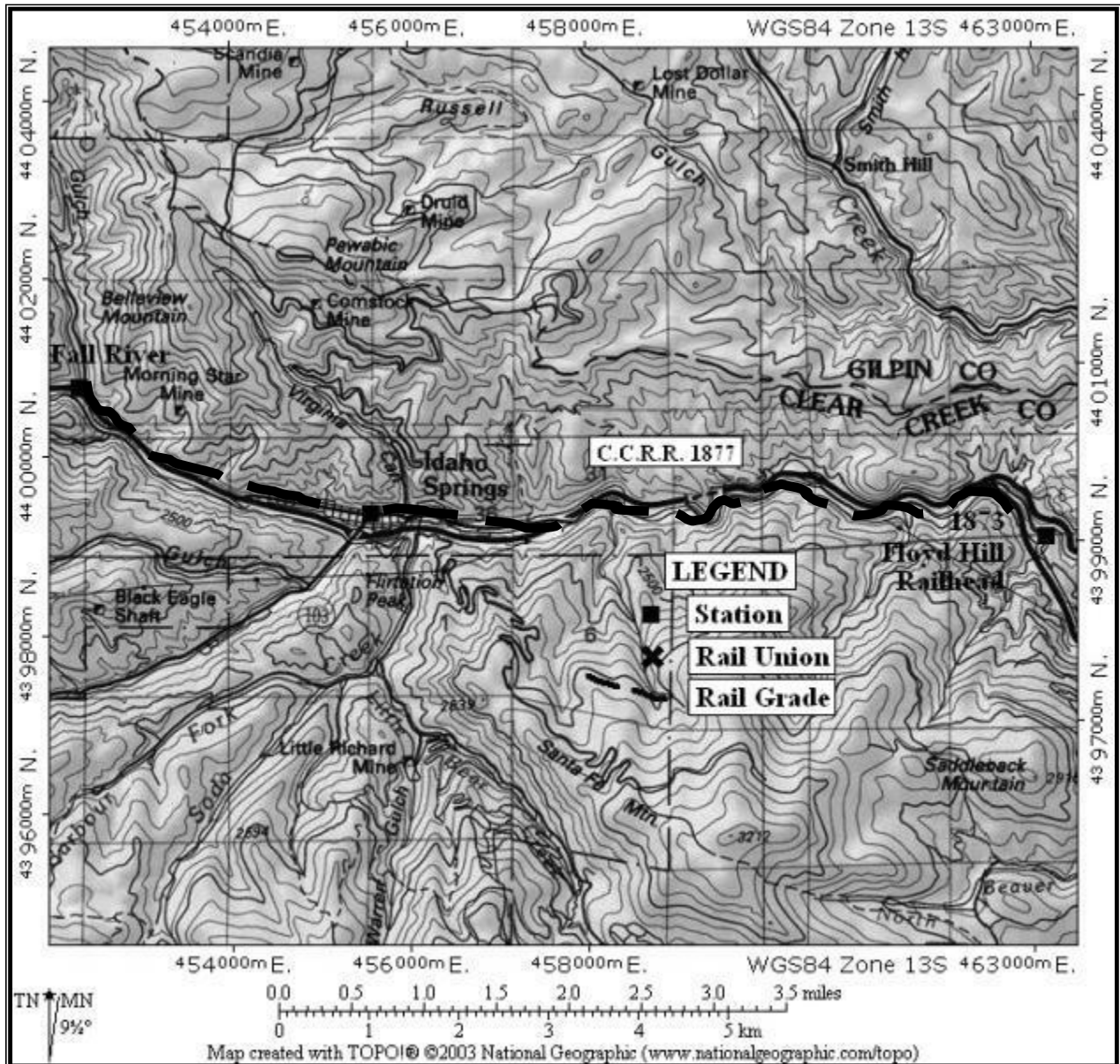


Illustration A 5.2: The heavy dashed line approximates the Colorado Central Railroad segment between Floyd Hill, at far right, and the hamlet of Fall River, at left. The route follows the south side of Clear Creek to the right of Idaho Springs, and the north side to the left. The solid line represents I-70, superimposed over the route’s western portion. Source: National Geographic TOPO! digital map (on CD), modified.

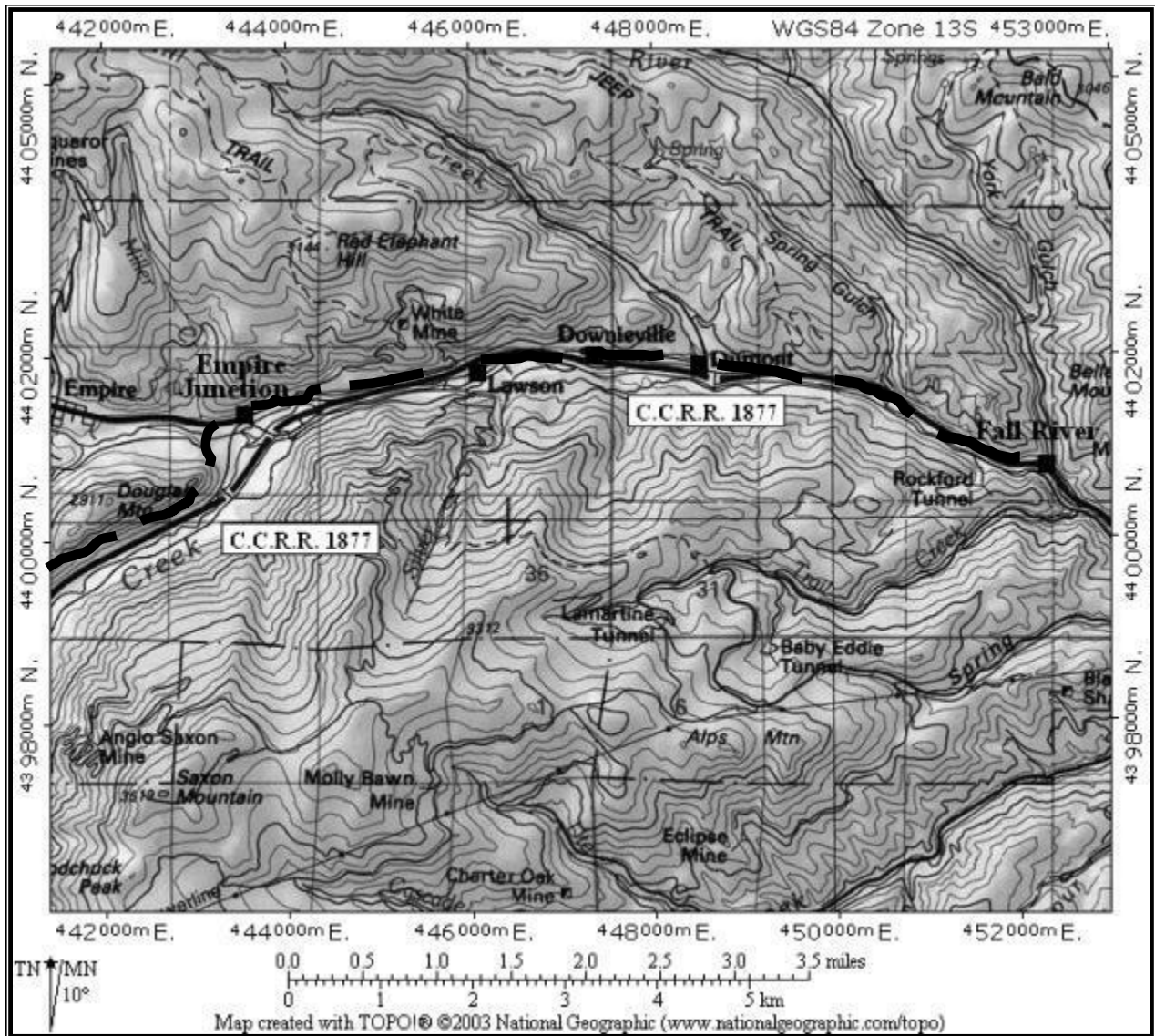


Illustration A 5.3: The dashed line charts the Colorado Central Railroad segment between Fall River, at right, and a station at Empire Junction, at left. The route follows the north side of Clear Creek valley. The dark line represents I-70, superimposed over much of the route. Source: National Geographic TOPO! digital map (on CD), modified.

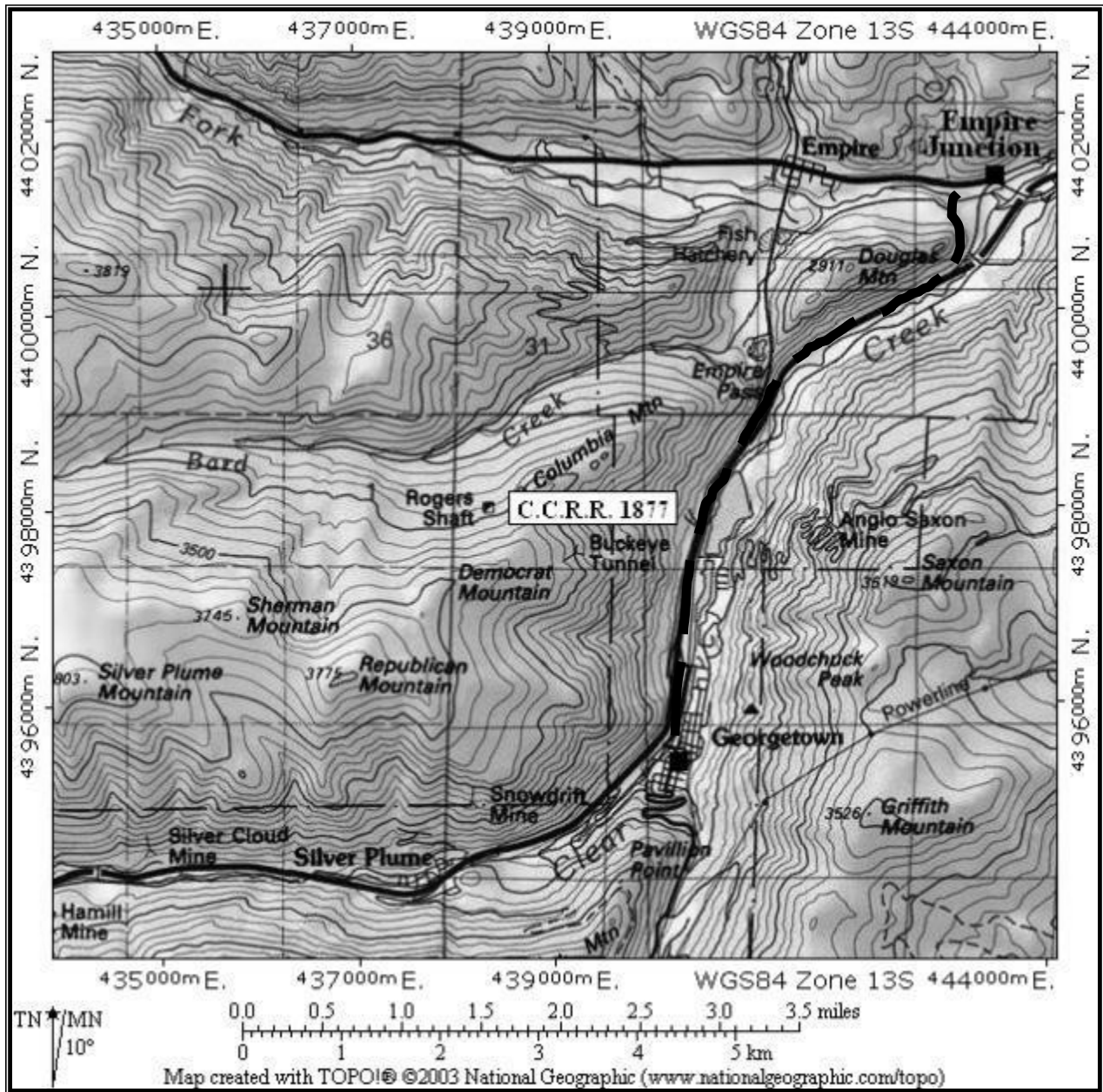


Illustration A 5.4: The dashed line approximates the Colorado Central Railroad segment between Empire Junction, at upper right, and the yard at Georgetown, center. The route extends along the west side of Clear Creek valley. The unbroken dark line denotes I-70, which may be superimposed over portions of the route. Source: National Geographic TOPO! digital map (on CD), modified.

Georgetown, Breckenridge & Leadville Railroad: Built, 1881-1884

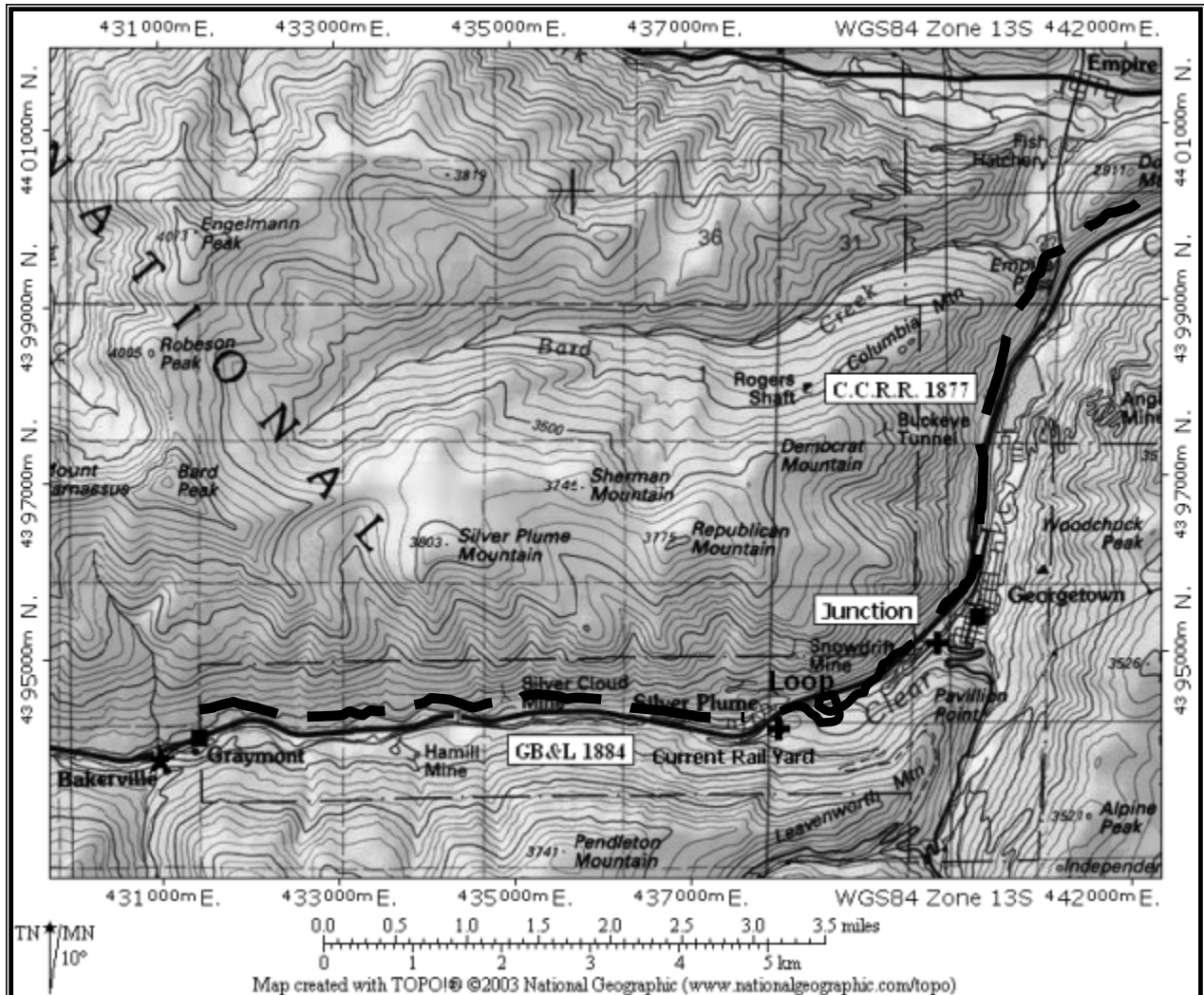


Illustration A 5.5: The Georgetown, Breckenridge & Leadville Railroad (dashed line) extended along Clear Creek valley between the Colorado Central yard at Georgetown, right, and a terminal at Graymont, left. The curves west of Georgetown represent the Georgetown Loop. The unbroken, dark line denotes I-70, which may be superimposed over the segment to Graymont. Source: National Geographic TOPO! digital map (on CD), modified.



Illustration A 5.6: The sinuous series of curves and crossover on the Georgetown, Breckenridge & Leadville Railroad were collectively known as the Georgetown Loop. The crossover, made possible by the steel High Bridge, was an engineering feat recognized industry-wide. Enhanced by an impressive alpine setting captured in this 1880s William Henry Jackson photo, the Loop drew tourists from across the nation. Courtesy of Denver Public Library, CHS.J2201.

Argentine Central Railroad: Added to System, 1905-1911

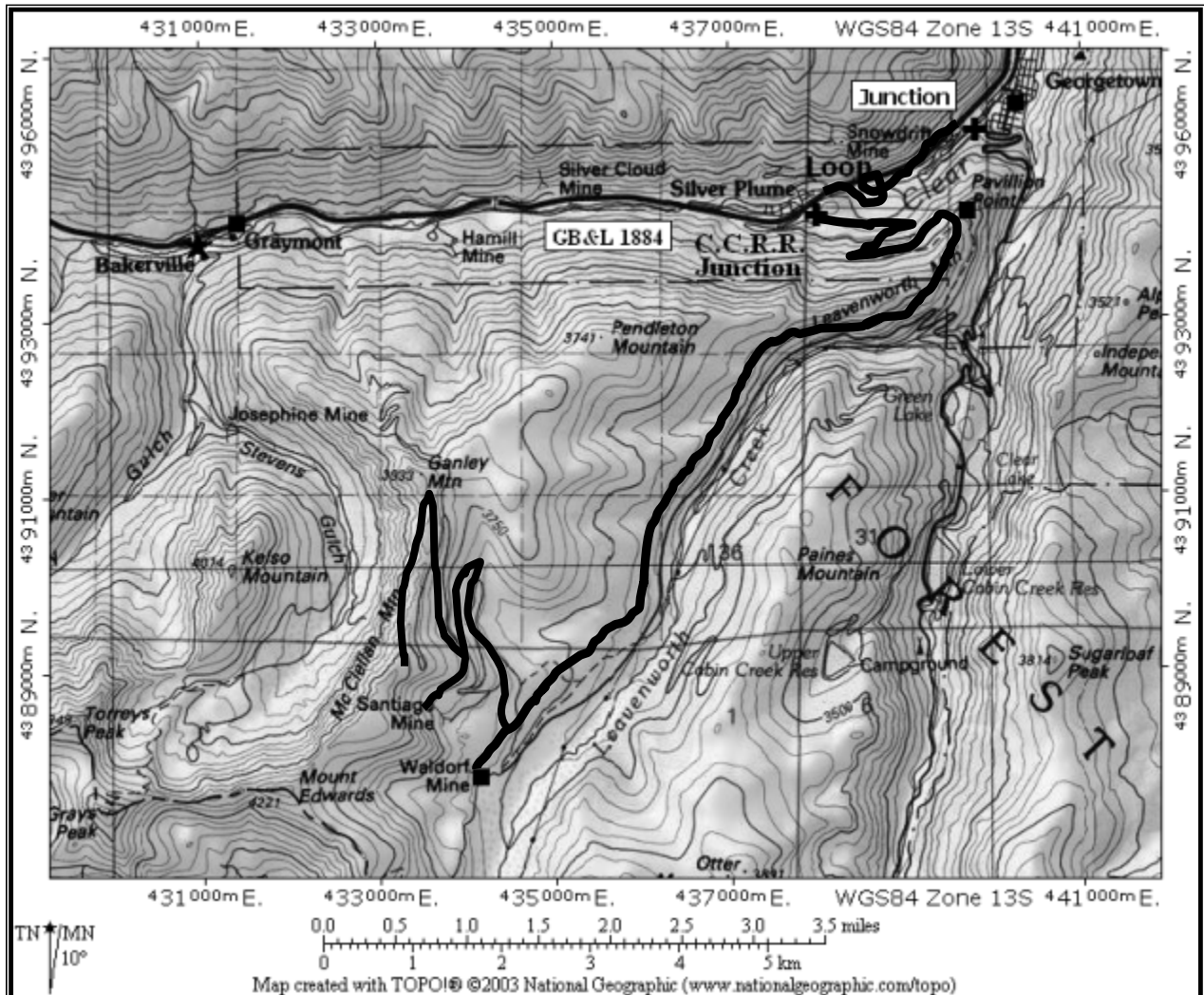


Illustration A 5.7: The Argentine Central Railroad climbed steeply from the Colorado Central yard at Silver Plume, top, to a terminal at Waldorf, lower left. The switchbacks ascended past the principal mines in the Argentine Mining District to an observation post on McClellan Mountain. Waldorf featured a tourist hotel and mining facilities. The segment along Leavenworth Creek may presently be a gravel road. Source: National Geographic TOPO! digital map (on CD), modified.



Illustration A 5.8: This side-gear locomotive, known as a Shay design, made the Argentine Central Railroad possible. The Shay was the only type capable of pulling cars up the tortuous and steep grades from Silver Plume into the Argentine Mining District. The photo was taken on the Argentine Central around 1910. Courtesy of Denver Public Library, X-17687.



Illustration A 5.9: The Argentine Central was the highest railroad in North America and neatly complimented the Georgetown Loop as a national tourist attraction. The railroad was as important as an industrial carrier for mining companies in the Argentine Mining District, right and out of view. In circa 1908 view, an excursion train parked at the top of McClellan Mountain. Courtesy of Denver Public Library, MCC-682.

TEN MILE CANYON AND BLUE RIVER RAILROAD SYSTEM, 1882-1937

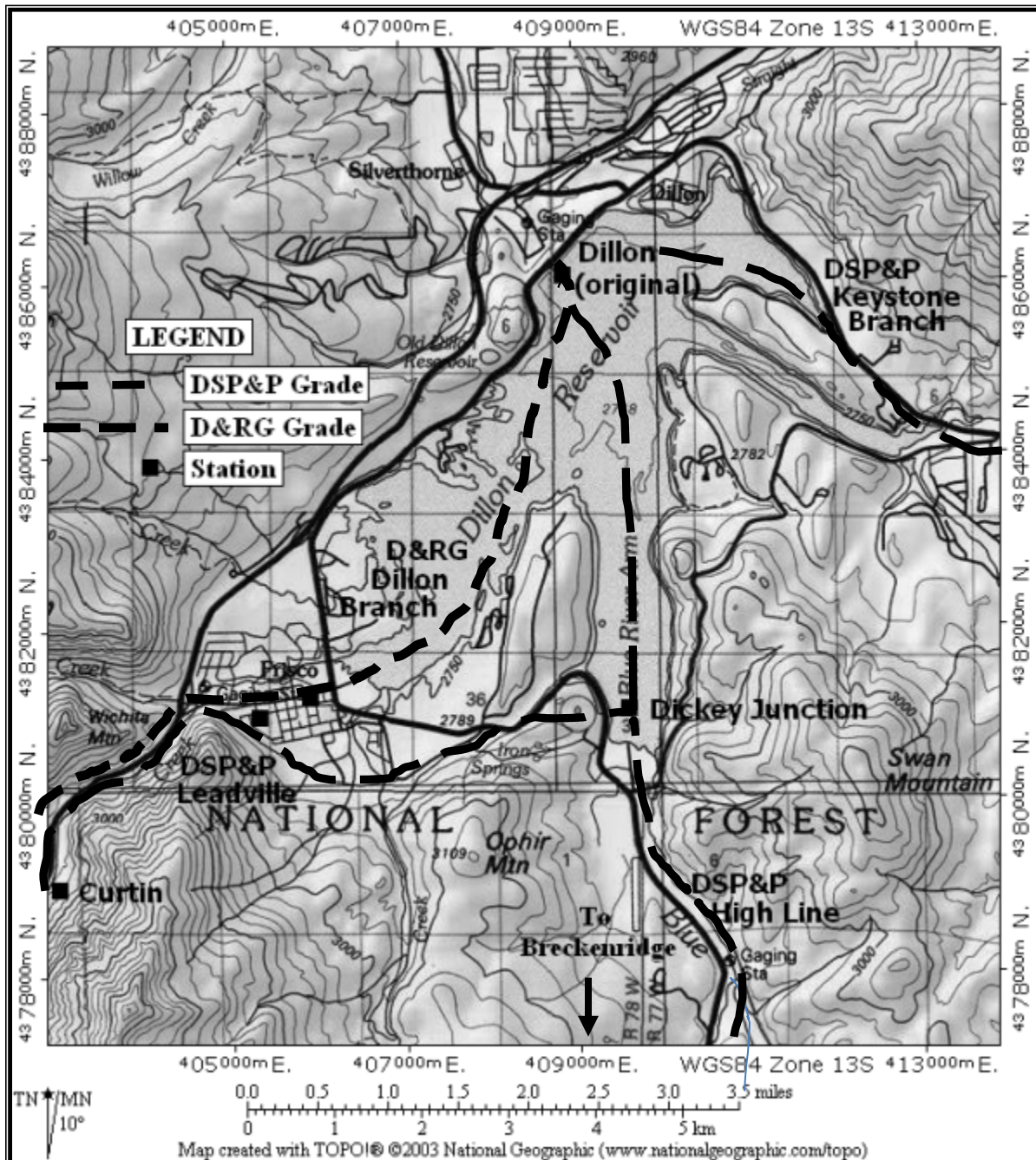


Illustration A 5.10: The map approximates Denver & Rio Grande and Denver, South Park & Pacific railroads to Dillon. I-70 and U.S. 6 are dark, unbroken lines crossing northeast to southwest. Source: National Geographic TOPO! digital map (on CD), modified.

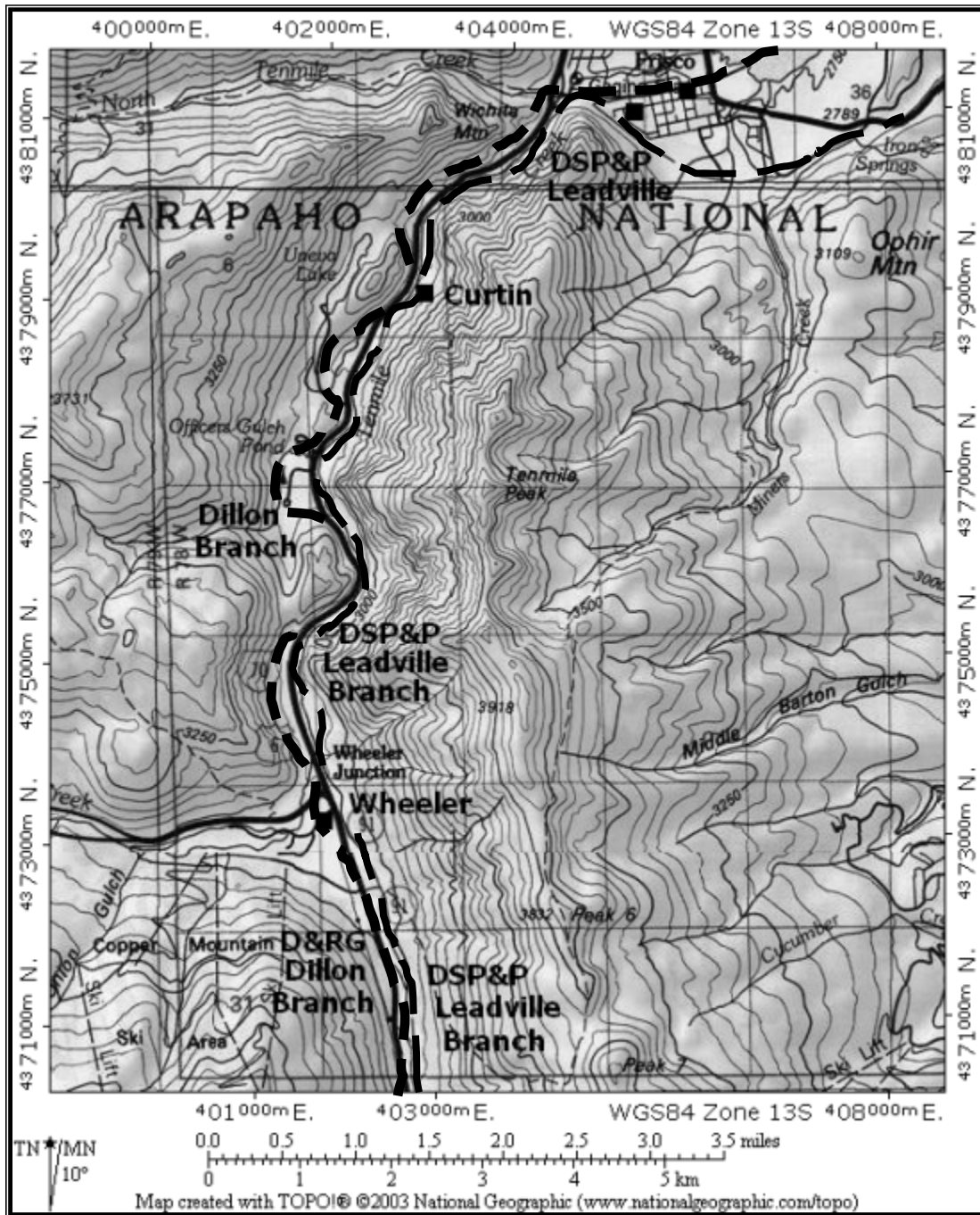


Illustration A 5.11: The map is the southern continuation of the Denver & Rio Grande Dillon Branch and the Denver, South Park & Pacific High Line, above. The dark, unbroken line marks I-70 and U.S. 6, following Ten Mile Canyon and turning west at Wheeler. Source: National Geographic TOPO! digital map (on CD), modified.

DSP&P: Builds the High Line, 1881-1884

Illustration A 5.12: A Denver, South Park & Pacific train stops at the Dillon Station during the late 1880s. Although the Denver & Rio Grande already served Dillon, DSP&P further reduced transportation costs and time. Also, DSP&P was the only railroad passing completely through Summit County. Courtesy of Denver Public Library, X-7704.

Denver, Leadville & Gunnison Railroad: Operates the High Line, 1894-1897

Illustration A 5.13: The Colorado & Southern Railroad assumed the High Line from Dillon to Leadville in 1898 and continued service through Summit County. The route was instrumental in the region's late 1890s mining boom. The southwest view up Ten Mile Canyon, by Otto Westerman around 1908, shows the Mary Verna Powerhouse and siding at Curtin. I-70 was graded later on the canyon's far right side. Courtesy of Denver Public Library, X-62731.

D&RG Builds the Leadville to Glenwood Branch, 1881-1887

Illustration A 5.14: The Denver & Rio Grande was hesitant about grading a line from Leadville to Glenwood Springs because Glenwood Canyon, confined by sheer cliffs, presented an obstacle. DR&G President William Jackson wanted to capture the Aspen market and pushed through anyway in 1886, despite objections. The line not only paid for itself, but also became a vital link in the only transcontinental route over the Rockies. William Henry Jackson took the photo. Courtesy of Denver Public Library, CHS.J2424.



Illustration A 5.15: When the Denver & Rio Grande began grading the Leadville to Glenwood Springs line in 1886, company surveyors platted Minturn as a service town. Minturn then developed its own local economy that included logging and ranching. The compact business district was characteristic of 1880s industrial towns, including a mix of false-front and gabled façades. Courtesy of Denver Public Library, X-12337.

D&RGW Builds the Dotsero Cutoff, 1930-1933

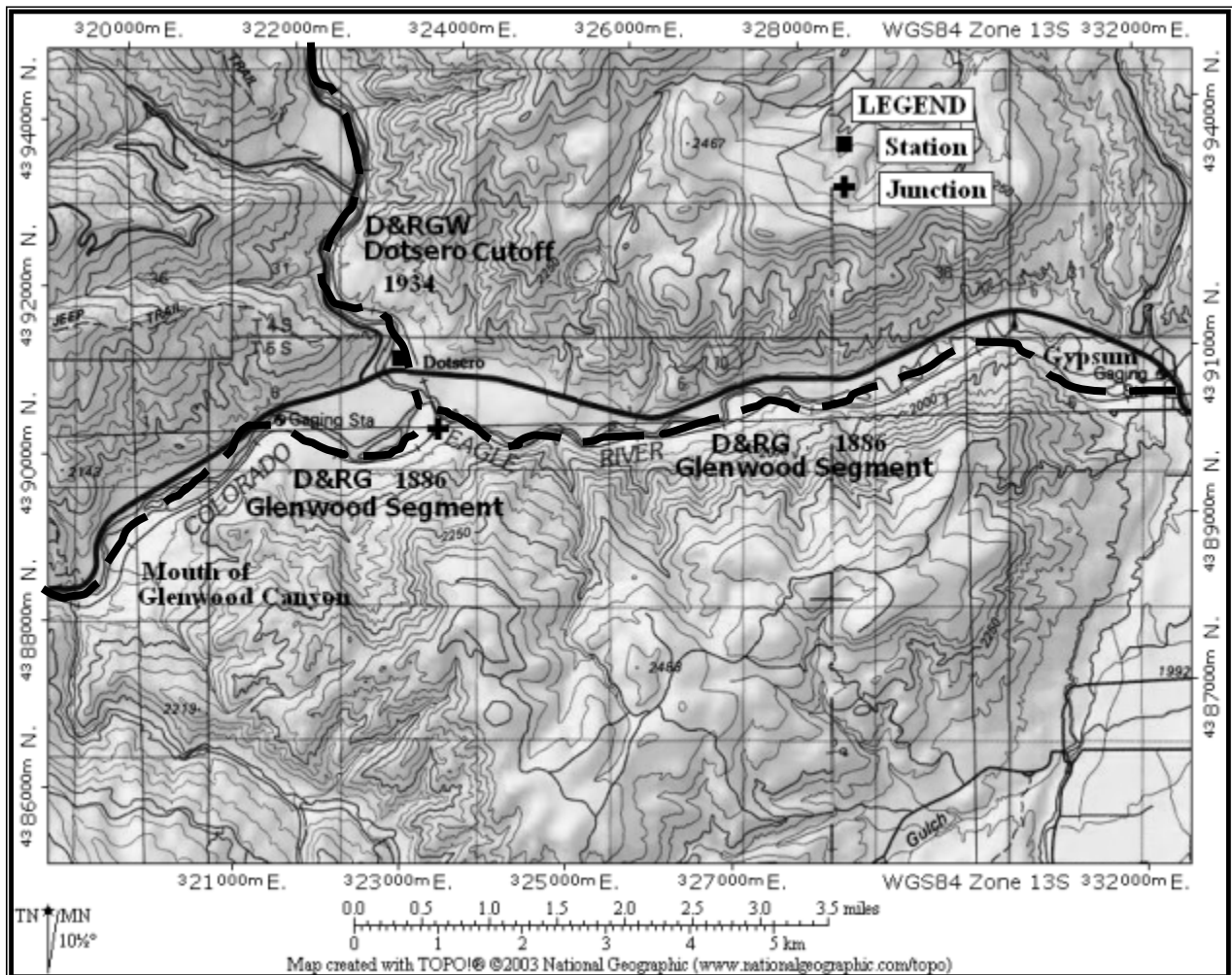


Illustration A 5.16: The dashed lines illustrate the junction of the Denver & Rio Grande Glenwood line and the Dotsero Cutoff, which intersected the Denver & Salt Lake Railroad far northwest and off the map. The junction is also the confluence of the Eagle River, continuing east, and Colorado River continuing north. The map predates I-70, and the unbroken, dark line represents U.S. 6. Source: National Geographic TOPO! digital map (on CD), modified.

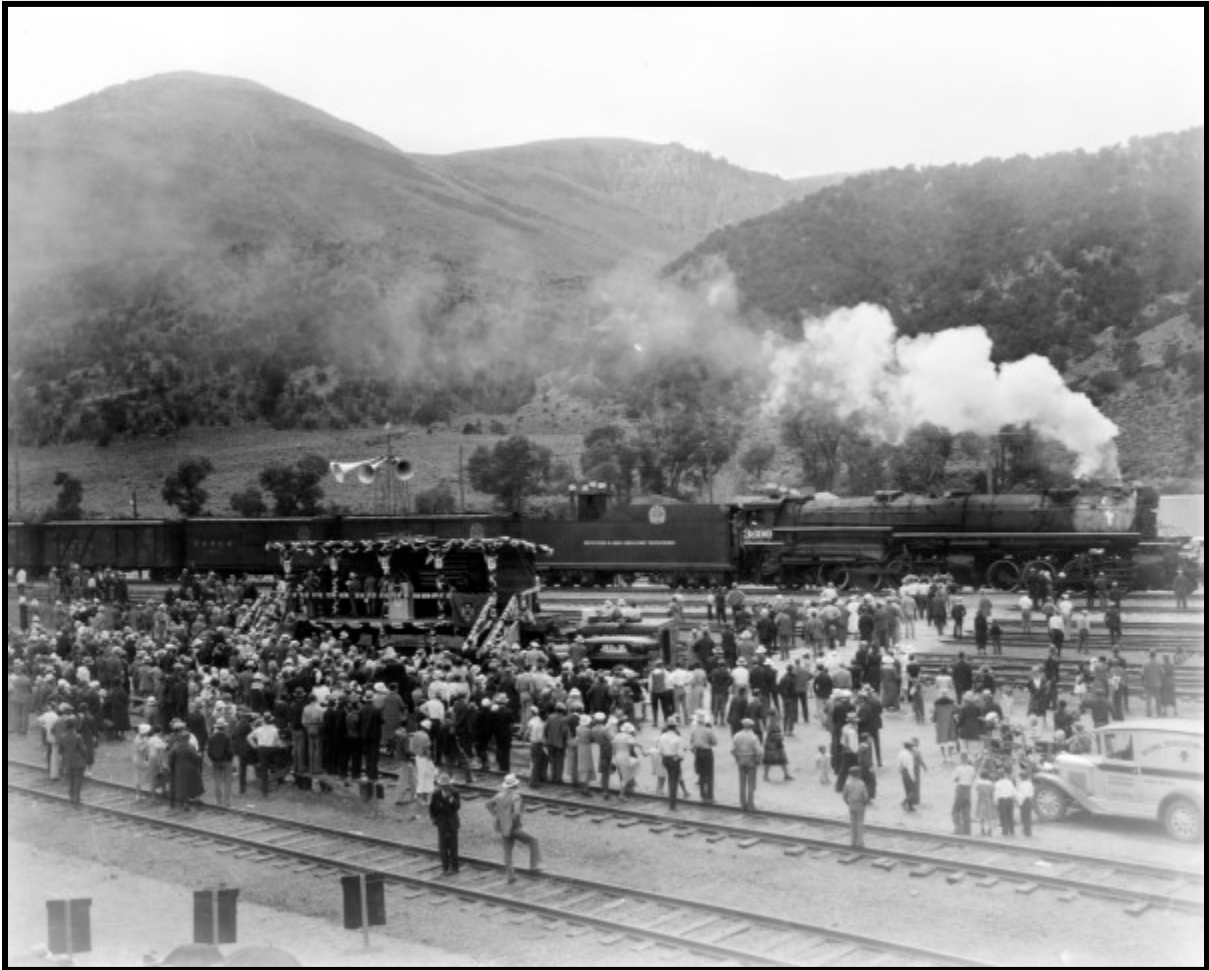


Illustration A 5.17: The Dotsero Cutoff was completed in 1934 and opened with a formal celebration, photographed by George L. Beam. In connecting the Denver & Rio Grande and Denver & Salt Lake systems, the cutoff shortened the only transcontinental route over the Rocky Mountains and improved Denver's strategic importance as a rail center. Courtesy of Denver Public Library, GB-7796.

D&RGW Absorbed, 1947-1988

Illustration A 5.18: The scenery of Glenwood Canyon inspired the Denver & Rio Grande to develop platform observation cars for its transcontinental passenger trains. The cars made the California Zephyr a household name among travelers during the 1950s, and increased the railroad's revenues. Otto Roach captured this speeding train in 1948. Courtesy of Denver Public Library, Z-6349.

Section A 6: History of Road Transportation, 1859-1962

Pack Trails and Wagon Roads, 1859-1892



Illustration A 6.1: The period-drawn map illustrates Prospector's Trail, among the most popular gold rush routes into Clear Creek drainage. Courtesy of Denver Public Library, CG4312.P25 192 D3.

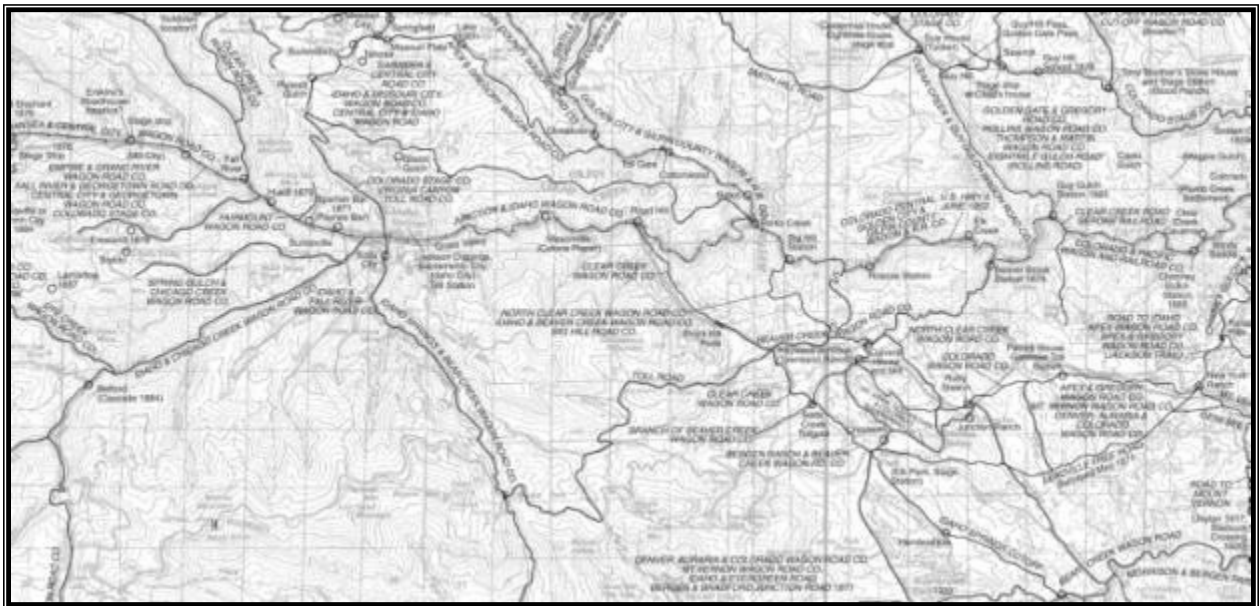


Illustration A 6.2: Wagon Roads through Denver Quadrangle, Golden to Lawson. Source: Glenn Scott's 1999 Historic Trails Map of the Denver Quadrangle.

Illustration A 6.4: The historic map illustrates Denver Mountain Parks auto roads. Courtesy of Denver Mountain Parks.

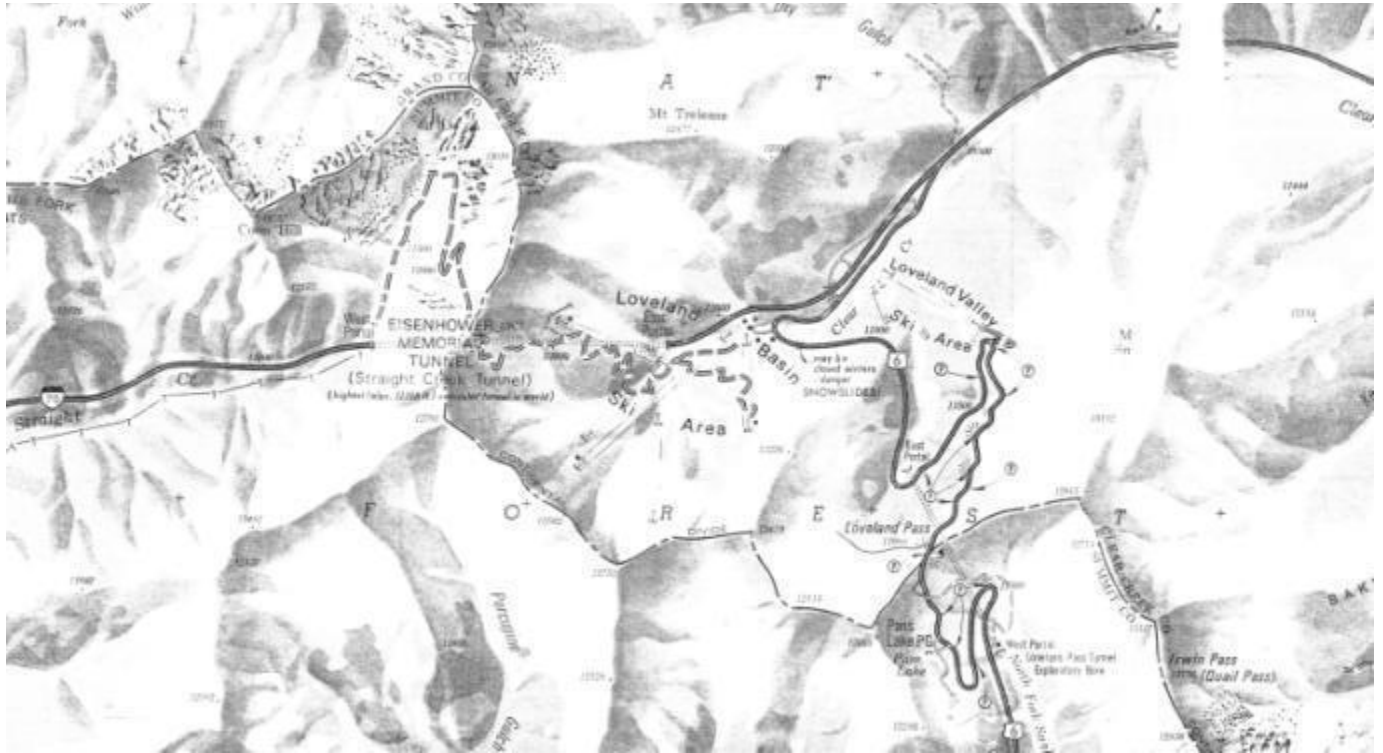


Illustration A 6.5: The map illustrates I-70 and the tunnels crossing under the Divide. The original Loveland Pass wagon road, now U.S. 6, crosses Loveland Pass to the south. The dashed line is an early and unidentified wagon road. Courtesy of Denver Public Library, CG4312.L66 1973.R6.



Illustration A 6.6: The map depicts the network of wagon roads and trails around the upper Eagle River valley. Source: Glenn Scott's 2004 *Historic Trails in the Leadville Quadrangle*.



Illustration A 6.7: The map depicts the network of wagon roads and trails around the Colorado River valley. Source: Glenn Scott's 2004 *Historic Trails in the Leadville Quadrangle*.

Early Automobile Roads, 1910-1932



Illustration A 6.8: Taylor State Road through Glenwood Canyon as photographed by Harry Mellon Rhoads during the 1920s. Courtesy of Denver Public Library, RH-280.

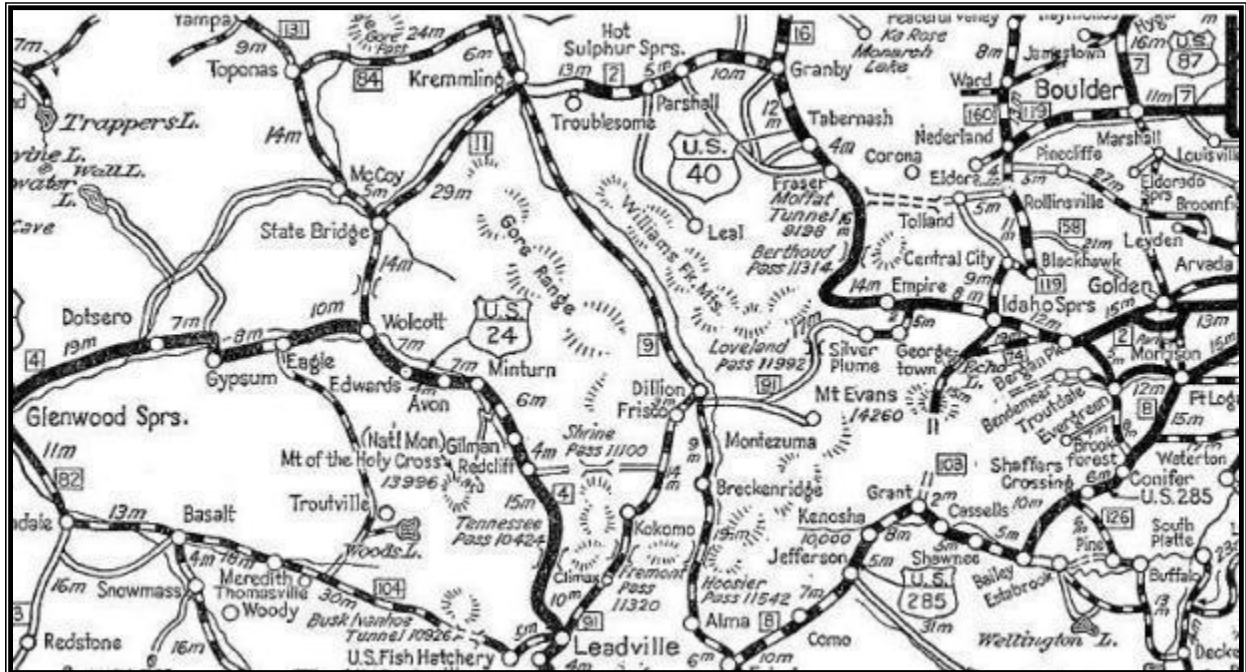


Illustration A 6.9: Road map of central Colorado in 1936. Courtesy of Colorado School of Mines, G4311.P2 1936.R6.

Section A 7: History of Tourism and Recreation, 1860-1962**History of Scenic Tourism and Resorts**

Illustration A 7.1: Although rough and primitive, the Mammoth Bath House at Idaho Springs may have been the earliest destination resort in the I-70 corridor. The early 1860s building at left was later replaced by several large resorts that catered to wealthy tourists from the Midwest and East. Courtesy of Denver Public Library, X-2237.



Illustration A 7.2: The luxurious Natatorium, photographed between 1900 and 1910, replaced the old Idaho Hot Springs resort and offered baths, steam rooms, and other amenities. Tourists came from across the nation. Courtesy of Denver Public Library, X-2336.



Illustration A 7.3: Tourists interested in an intimate experience with the Rocky Mountains stayed at the Green Lake resort above Georgetown. The hotel, pictured in the 1880s, is on the far shore. Courtesy of Denver Public Library, C-13.



Illustration A 7.4: Mountaineers, few in number during the nineteenth century, stayed in the Jennings Hotel at Graymont before and after testing themselves against Gray's and Torrey's peaks. The hotel, photographed by George Dagleish around 1884, gave the mountaineers a taste of frontier accommodations until the railroad ended service in 1893. Courtesy of Denver Public Library, X-8760.

History of Outdoor Recreation

Illustration A 7.5: In those regions lacking campgrounds, auto tourists simply camped in forests accessible by road. This family vacationing in Eagle or Summit County in 1917 was on the forefront of a growing recreational movement. Auto camping is presently one of the most important contributors to the economy of the I-70 corridor. Courtesy of Denver Public Library, Z-7801.

Section B 1: Mining Industry Property Types and Registration Requirements**PROPERTY TYPE: PLACER MINE**

Illustration B 1.1: The photo depicts a typical gulch placer mine, featuring a sluice on one side of the drainage floor, tailings on the other, and high-bank excavations on both sides. Although the mine is in La Plata County during the mid-1870s, the general form was universal. Courtesy of Denver Public Library, WHJ-10197.



Illustration B 1.2: The 1867 photo captures a typical stream placer on Chicago Creek near Idaho Springs. The mine is characteristic of company operations with engineered sluices, log cribbing walls that retain pits, a hoisting derrick to remove boulders, and large tailings piles. Courtesy of Denver Public Library, X7604.

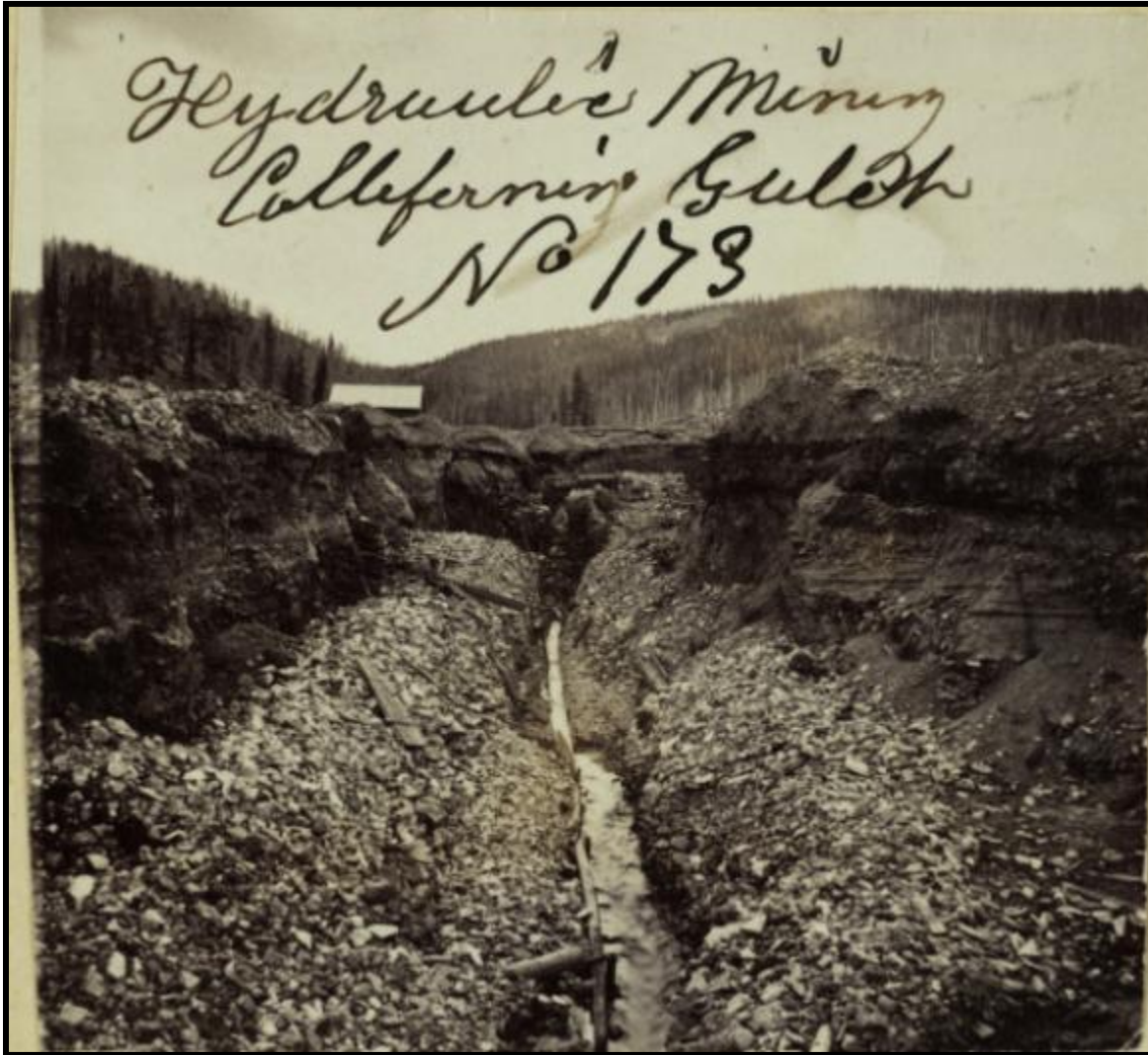


Illustration B 1.3: In hydraulic placer mines, the workings usually feature high and precipitous cut-banks, collections of boulders, and a central drain that directed effluent into sluices. The hydraulic monitor, water system, and sluices are out of view. Although the photo is in California Gulch near Leadville, hydraulic placers existed near Idaho Springs and Empire. Courtesy of Denver Public Library, X-19197.



Illustration B 1.4: Hydraulic mines followed a common pattern in engineering and workings. Monitors emitted high-pressure jets of water that eroded gold-bearing gravel and washed slurry through a system of sluices. The operation in the photo was the Iowa Hill Mine near Breckenridge, Summit County, during the 1880s. Courtesy of Breckenridge town historian Rebecca Waugh.

PROPERTY TYPE: HARDROCK PROSPECT

Illustration B 1.5: The Thompson Mine near Breckenridge in 2003, is characteristic of deep prospect shafts. These operations typically had a simple headframe and blacksmith shop enclosed in a shaft house. Additional property development is absent, and the waste rock dump limited in volume. Archaeological features represent the buildings and structures at most sites. Source: Eric Twitty.

PROPERTY TYPE: HARDROCK MINE

Illustration B 1.6: The Gem Mine on Seaton Mountain above Idaho Springs around 1910 typifies large, professionally engineered shaft operations. A complex shaft house enclosing the shaft collar, hoisting system, steam boilers, and shop stands at left. A large waste rock dump and series of ore bins extends right. Most mines were not as extensive as the Gem but featured similar characteristics. Courtesy of Denver Public Library, X-60758.



Illustration B 1.7: Most tunnel mines, such as this operation near Georgetown during the 1890s, were small and simple. Surface facilities consisted of a blacksmith shop, tunnel portal, rail line, ore bin, and little else. Even when buildings and structures are gone, tunnel mines may be eligible for the NRHP if the archaeological features and artifacts clearly represent the operation. Courtesy of Denver Public Library, X-61651.

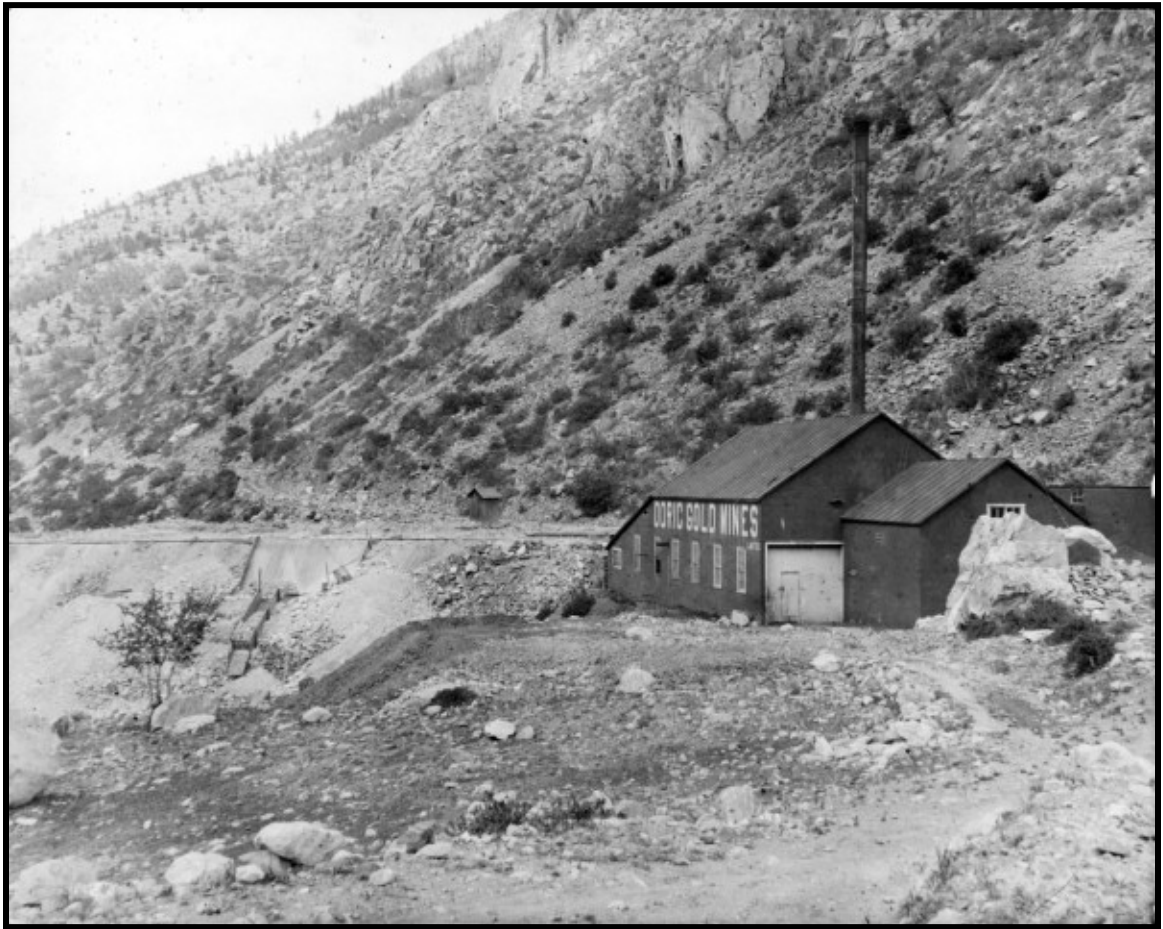


Illustration B 1.8: The Doric Mine near Georgetown, pictured around 1890, is typical of mechanized tunnel mines. A tunnel house encloses the tunnel portal, shops, air compressor, and steam boiler. A chute and decayed bin for ore lie on the waste rock dump's flank. Courtesy of Denver Public Library, X-61652.



Illustration B 1.9: Some mines, such as the Tenth Legion near Empire during the late 1860s, were a complex series of workings on a linear ore vein. In the photo, miners developed the upper portion through a shaft, marked by a shaft house at center, and the lower portion through a tunnel, with a log shop building at the lower right. Open-cuts exposed the vein in between. Note the ore chutes and log cribbing walls retaining waste rock. Courtesy of Denver Public Library, X-61589.



Illustration B 1.10: Underground mine workings, such as this shaft station in the Newhouse Tunnel around 1910, hold a high potential to yield important information. Few if any formal historical studies of underground workings have been completed, and much can be learned in the fields of mining engineering, practices of drilling and blasting, and the underground work environment. Because of this, underground workings may qualify for the NRHP under Criterion D, when preserved and safely accessible. Courtesy of Denver Public Library, X-61088.



Figure B 1.11: Eligible mines must possess physical integrity relative to a timeframe of significance. Mines heavily altered within the recent past, such as the Atlantic Tunnel on Seaton Mountain above Idaho Springs in 2005, usually lack sufficient integrity. Source: Eric Twitty.

Figure B 1.12: Shafts that suffered catastrophic collapse, such as the Columbia in Boulder County pictured in 2009, may lack sufficient integrity for eligibility. Massive collapse often impacts the assemblage of archaeological features necessary for site interpretation. Source: Eric Twitty.



PROPERTY TYPE: ORE TREATMENT MILL

Illustration B 1.13: The Pay Rock Mill, on the north side of Clear Creek near Silver Plume in 1880, is a good example of a typical concentration facility. The building descends over a series of stairstep foundations, which are often all that remain at mill sites today. Courtesy of Denver Public Library, X-61593.

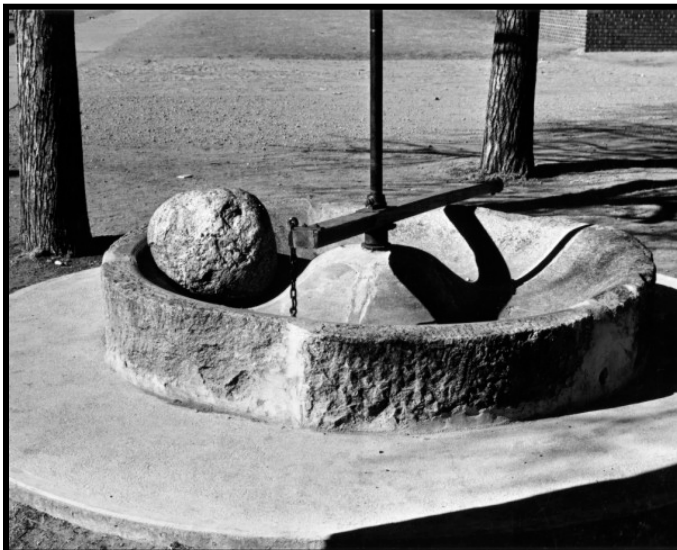


Figure B 1.14: An arrastra was a circular stone floor with capstan at center, harness beam, and muller stone. The one pictured here in 1939 was moved to Idaho Springs for public viewing. An arrastra must retain integrity of location for eligibility. Courtesy of Denver Public Library, X-62938.

PROPERTY TYPE: SMELTER

Illustration B 1.15: When the Dibben Smelter at Argentine was photographed during the late 1890s, it had already been long abandoned. The facility is typical of the smelters built in Clear Creek drainage during the late 1860s and early 1870s, with local stone chimney and furnace, and small building built over several stairstep foundations. Masonry and foundations are all that remain from most smelters of the vintage. Courtesy of Denver Public Library, X-61397.

PROPERTY TYPE: PROSPECTOR'S CAMP

Illustration B 1.16: The prospector's camp photographed on Horse Mountain south of Eagle in 1913 reflects how field accommodations changed little since the 1860s. The camp is typical with several wall tents on a cut-and-fill platform, and few if any other improvements. Courtesy of Denver Public Library, CHS-X5655.

PROPERTY TYPE: WORKERS' HOUSING



Illustration B 1.17: Boardinghouses, or their archaeological representations, are the most common resources clearly identifiable as workers' housing. This abandoned building once housed Conqueror Mine workers at North Empire. Courtesy of Denver Public Library, X-12513.

PROPERTY TYPE: MINING SETTLEMENT

Illustration B 1.18: Brownville, pictured near Silver Plume during the late 1880s, is a good example of an unincorporated settlement. Little if any planning, surveyed grids of lots and blocks, or other organization is evident. Instead, the settlement grew organically at the intersection of several roads leading to mines, with houses, mostly vernacular in design and appearance, located as the builders wished. Courtesy of Denver Public Library, X-7233.

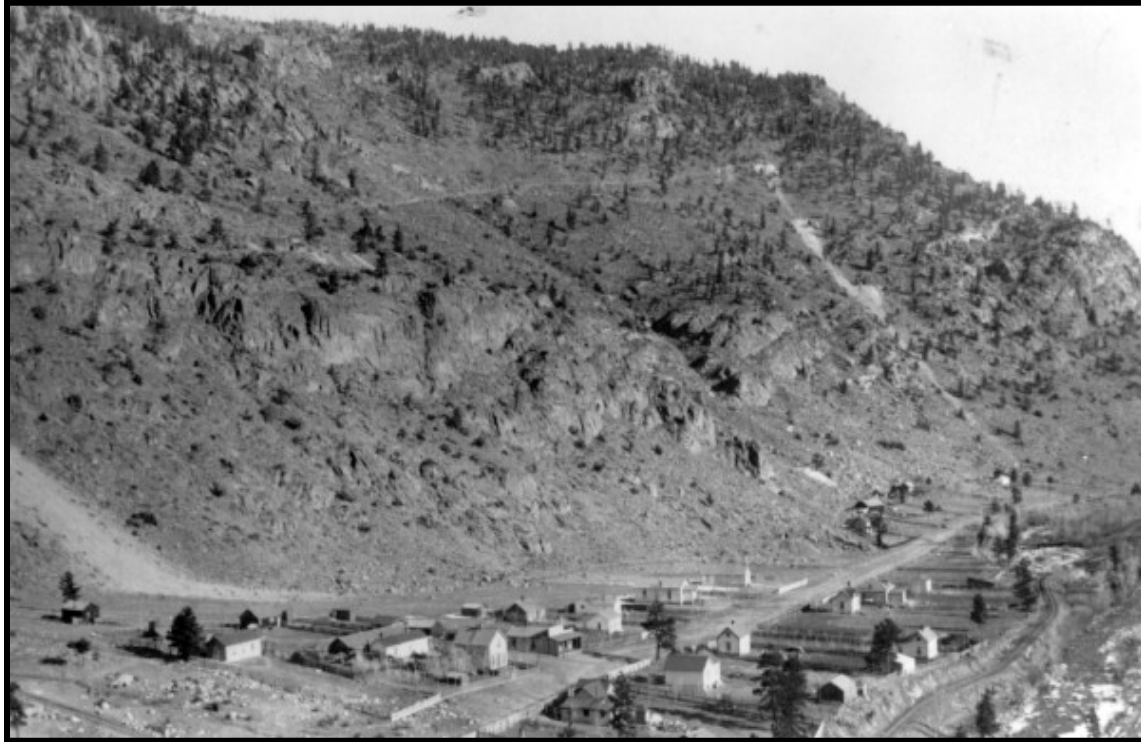


Illustration B 1.19: Lawson, photographed around 1890, embodies many characteristics of a formally platted townsite. A small business district grew along a main street, and residences lie around the district's edges. Overall, the buildings conform to a grid of lots and blocks. Courtesy of Denver Public Library, X-12002.



Illustration B 1.20: Most mine residences were small cabins, usually represented today either as earthen platforms or ruins such as the one above near Breckenridge in 2003. Source: Eric Twitty.

Section B 2: Timber Industry Property Types and Registration Requirements**PROPERTY TYPE: SAWMILL SITE**

Illustration B 2.1: Most of the sawmills in the I-70 corridor were small facilities such as this one photographed near Silver Plume in 1938. They were simple for portability and relocation to fresh forests. The sawmill, frame enclosing the saw-frame, and building surrounding the saw-blades and engine are at left. Finished lumber and logs are stockpiled near center, and workers' housing is right. Courtesy of Denver Public Library, X-17668.

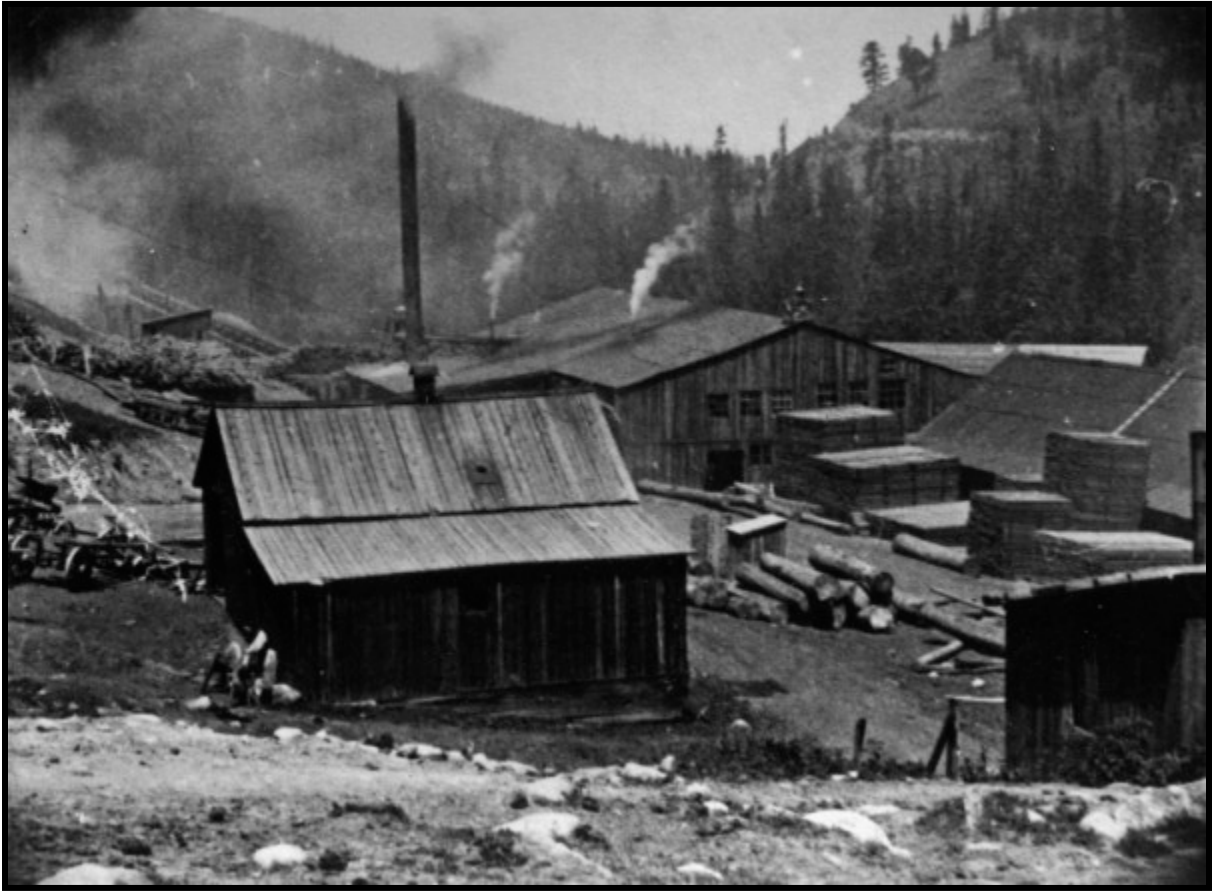


Illustration B 2.2: The I-70 corridor featured a few large sawmills comparable to the W.H. Woods plant in Winter Park, photographed around 1910. The large building in center background houses the saw-blades, steam engine, boiler, and planing machinery. A residential cabin stands in the foreground, raw logs are stacked in rows in the distant background, while finished lumber is stacked at right. Courtesy of Denver Public Library, X-14066.

TIMBER INDUSTRY SITE FEATURES

Illustration B 2.3: Sawmill sites today are represented primarily by archaeological features such as foundations, debris, and ruins. The sawmill site in the 2005 photo, near Breckenridge, includes engineered structures and machinery, as well. The object near center is a drive engine, which is rare at sites today. The debris alignment represents a partially intact saw-frame. Source: Eric Twitty.

Section B 4: Electric Power Property Types and Registration Requirements

Illustration B 4.1: This powerplant, photographed by Charles McClure on the floor of Clear Creek near Idaho Springs around 1910, probably belonged to the Seaton Mountain Electric Light, Heat & Power Company. The plant is a good example of a hydro facility. A flume delivered water to penstocks, angled pipes descending into the building. Now under pressure, the water turned several dynamos within. Note the overflow channel at left. Powerhouses such as the one above tend to be represented by archaeological features such as foundations. Courtesy of Denver Public Library, MCC-371.

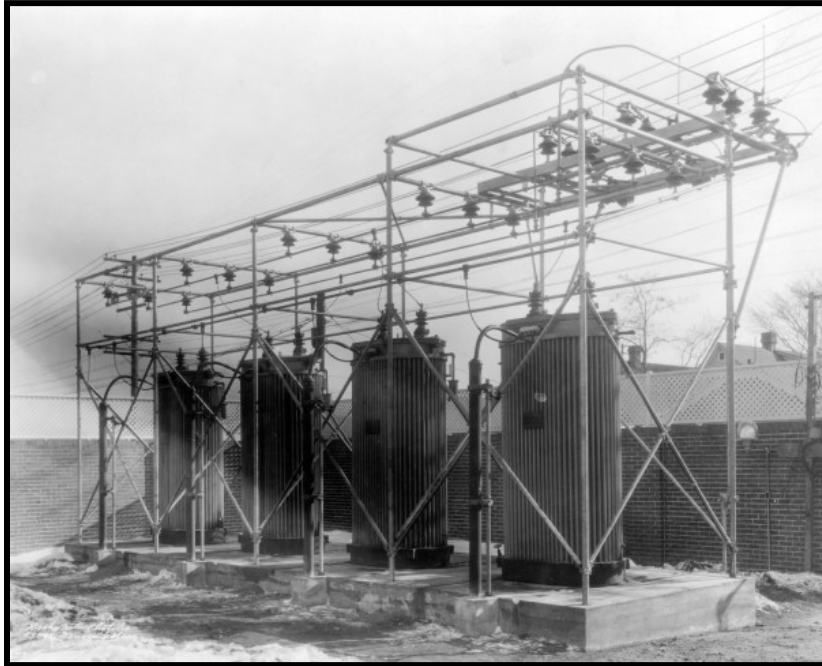


Figure B 4.2: This circa 1925 substation in Denver is representative of distribution facilities in I-70 corridor communities and industrial centers. The station consists of a bank of transformers, wiring, and frame on a concrete foundation. Courtesy of Denver Public Library, X-29755.

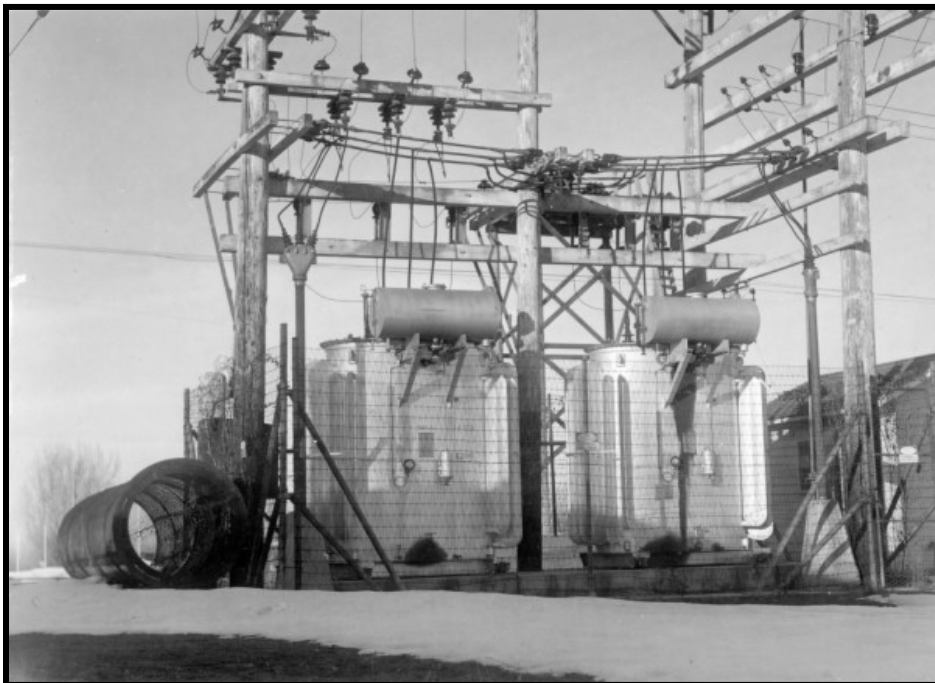


Illustration B 4.3: Substations such as the one above, circa 1925, converted electricity as generated in a powerplant for transmission, or from the transmission lines to a distribution system. The substation consists of incoming transmission lines, large transformers, and out-going lines. Courtesy of Denver Public Library, X-29750.



Illustration B 4.4: Infrastructure components include facilities and constructs in support of powerplants and their electric grids. Flumes and pipelines for hydropower, such as these in construction for the Stanley Mine near Idaho Springs in 1894, are the most common. Many have been dismantled and are now represented by archaeological features. Lachlan McLean took the photo. Courtesy of Denver Public Library, Z-4767.

Section B 5: Railroad Property Types and Registration Requirements**PROPERTY TYPE: RAILROAD TRACKS AND ROADBED**

Illustration B 5.1: The late 1880s William Henry Jackson photo of the Denver & Rio Grande line through Glenwood Canyon exemplifies a typical railroad grade and common characteristics. Evident are cuts and fills to level the grade, and gentle curves and straight lines required by locomotives. The track consists of rails, ties, and a veneer of ballast over the carefully flattened surface of the gravel bed. Courtesy of Denver Public Library, CHS.J3885.

PROPERTY TYPE: MISCELLANEOUS RIGHT-OF-WAY STRUCTURES

Illustration B 5.2: This circa 1925 George L. Beam photo shows a typical railroad tunnel and right-of-way objects and structures in Glenwood Canyon by the Shoshone diversion dam, left background. The utility pole is a structure, and the signal lights at right objects. All are contributing elements of the railroad as a resource. Courtesy of Denver Public Library, GB-6399.

PROPERTY TYPE: DEPOT



Illustration B 5.3: The Idaho Springs railroad depot, depicted by Otto Perry in 1941, was a combination type with typical architectural characteristics, including bay window, service doors, and deep roof overhang. The railroad tracks are on the other side. Courtesy of Denver Public Library, OP-6385.



Illustration B 5.4: Frisco featured a flag depot, photographed around 1900. This version was fully enclosed with wood stove to keep passengers warm in winter. Courtesy of Denver Public Library, X-8544.

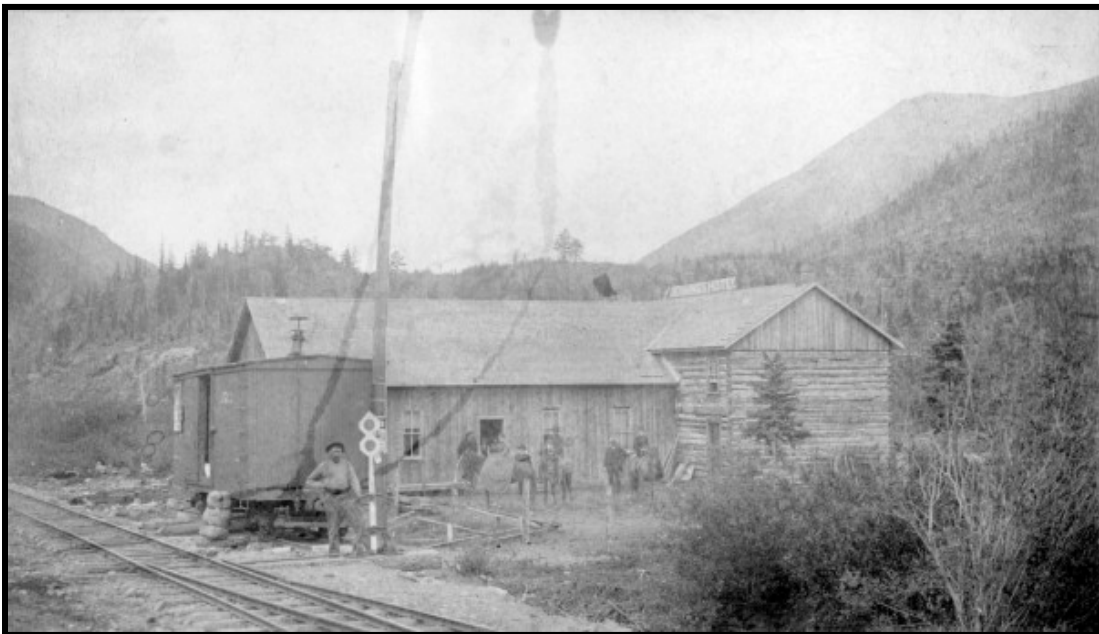


Illustration B 5.5: The boxcar at left is a temporary depot at Graymont, end of the line for the Georgetown, Breckenridge & Leadville Railroad. The depot, captured during the 1880s, served area mining companies and tourists staying at the Jennings Hotel, background. Courtesy of Denver Public Library, Z-2566.

PROPERTY TYPE: HOUSING AND MAINTENANCE FACILITIES

Illustration B 5.6: Railroad sidings and yards, such as this one photographed at Minturn by Robert Richardson in 1954, usually feature service buildings and structures. Service buildings and structures can be evaluated for significance individually, but are best done so within the context of the larger resource. Courtesy of Denver Public Library, RR-1739.

Section B 7: Tourism and Recreation Property Types and Registration Requirements



Illustration B 7.1: Photographed by Charles McClure between 1900 and 1920, this hunting camp near Norris is typical of the era, with several tents, table under a shelter, and sheet iron stove. Fishing camps were similar. Courtesy of Denver Public Library, MCC-1755.

Property Type: Domestic Residential Buildings



Illustration B 8.1: Alice Post Office, Clear Creek County. Pioneer Log building. Courtesy of Denver Public Library, X-6468, ca. 1880-1910



Illustration B 8.2: Klack Placer Cabin, Breckenridge. Pioneer Log building. Source: Carl McWilliams, 2010.



Illustration B 8.3: A-Frame building, Lake City, Colorado, (5HN.68.24) Courtesy Office of Archaeology and Historic Preservation, 2002.



Illustration B 8.4: Greek Revival style dwelling, Georgetown. Courtesy Denver Public Library, Z-9938, ca. 1880-1890.



Illustration B 8.5: Maxwell House, Second Empire style dwelling, Georgetown. Courtesy Denver Public Library, X-1277, ca. 1970.



Illustration B 8.6: Italianate style dwelling, Longmont, Colorado. Source: Carl McWilliams, 200



Illustration B 8.7: Italianate style dwelling, Loveland, Colorado. Source: Carl McWilliams, 2009.



Illustration B 8.8: Queen Anne style dwelling, Loveland, Colorado. Source: Carl McWilliams, 2009.



Illustration B 8.9: Edwardian style dwelling, Loveland, Colorado. Source: Carl McWilliams, 2010.



Illustration B 8.10: Dutch Colonial Revival style dwelling, Steamboat Springs, Colorado. Source: Carl McWilliams, 2007.



Illustration B 8.11: Craftsman style dwelling, Loveland, Colorado. Source: Carl McWilliams, 2009.



Illustration B 8.12: Craftsman style dwelling, Longmont, Colorado. Source: Carl McWilliams, 2006.



Illustration B 8.13: Rustic style dwelling, Loveland, Colorado. Source: Carl McWilliams, 2010.

Property Type: Commercial Buildings



Illustration B 8.14: False Front Commercial building, Clear Creek County. Courtesy of Denver Public Library, X-8541, ca. 1890-1900.



Illustration B 8.15: Snetzer's Tailor Shop, Single Storefront commercial building, Georgetown. Courtesy of Denver Public Library, X-1303, ca. 1950-1960.



Illustration B 8.16: Bank Block, Double Storefront commercial building, Idaho Springs. Courtesy of Denver Public Library, AUR-981, ca. 1990



Illustration B 8.17: Mahr Building, Telluride, Colorado, with 1892 Mesker Bros. cast iron facade. Source: Carl McWilliams, 2007.



Illustration B 8.-18: Sopp and Truscott Bakery, Corner Commercial building, Silver Plume, Courtesy of Denver Public Library, AUR-962, 2010



Illustration B 8.19: Routt County National Bank, Early Twentieth Century Commercial building, Steamboat Springs, Colorado. Source: Carl McWilliams, 2007.



Illustration B 8.20: Skee Inn Cafe, Early Twentieth Century Commercial building, Steamboat Springs, Colorado. Source: Carl McWilliams, 2007.



Illustration B 8.21: House with Canopy filling station, Denver, Colorado. Courtesy of Denver Public Library, X-23806, ca. 1920-1930.



Illustration B 8.22: Cottage filling station with attached service bay, Longmont, Colorado. Source: Carl McWilliams, 2010



Illustration B 8.23: Enco/Humble Oblong Box filling station, Denver, Colorado. Courtesy Denver Public Library, MCD-19, ca. 1950-1960.



Illustration B 8.24: Texaco Oblong Box filling station, Ignacio, Colorado. Courtesy Denver Public Library, X-17788, ca. 1980-1990

Cultural, Religions and Public Buildings

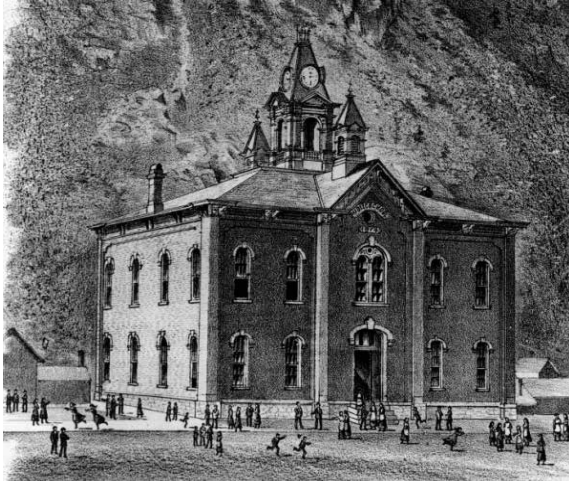


Illustration B 8.25: Georgetown School, Georgetown. Courtesy of Denver Public Library, X-11393, ca. 1874.



Illustration B 8.26: Silver Plume School, Silver Plume. Courtesy of Denver Public Library, X-2162, 1908.



Illustration B 8.27: Silver Plume Town Hall, Silver Plume. Courtesy of Denver Public Library, X-2209, ca. 1954



Illustration B 8.28: Silver Plume Jail, Silver Plume. Courtesy of Denver Public Library, X-2181, 1966.



Illustration B 8.29: Star Hook and Ladder Firehouse, Georgetown. Courtesy of Denver Public Library, X-1299, 1951



Illustration B 8.30: Alpine House Company No. 2, Georgetown. Courtesy of Denver Public Library, X-1048, 1942.



Illustration B 8.31: Carpenter Gothic style church, Gypsum, Colorado. Courtesy of Denver Public Library, X-3424, 1942



Illustration B 8.32: Carpenter Gothic style church, Georgetown. Courtesy Denver of Public Library, ca. 1933-1970.

PROPERTY TYPE: COMMERCIAL BUILDINGS



Illustration B 8.33: Heart of the Rockies Motel in Dillon. Courtesy of Denver of Public Library, X-7716, ca. 1950.



Illustration B 8.34: Arched entryway and neon sign for Bill's Modern Court Motel in Granby, Colorado. Courtesy of Denver Public Library, X-9779, 1980.



Illustration B 8.35: Harvey-Shyrack Motors / Longmont Motors Company Building, Longmont, Colorado. Source: Carl McWilliams, 2006.



Illustration 8.36: Harold's Garage, Denver, Colorado. Courtesy of Denver Public Library, Z-10865, 1950.

Copyright restrictions apply to all images in this document. Denver Public Library images may not be reproduced for use, other than in this document, without permission from Denver Public Library, Western History.